

ARTEFERRO *Compendium*

La parola viene dal Latino "compenso" che significa

(tra l'altro) "pesare assieme" "BILANCIARE"

Non vuole quindi essere un semplice RIASSUNTO (che pure è un altro dei significati che può avere la parola COMPENDIUM) ma qualcosa di più. Il nostro "COMPENDIUM ARTEFERRO" 2010 vuol essere una GUIDA RAGIONATA a tutto ciò che Ind.i.a. spa offre al mondo della RECINZIONE e del METALLO ORNAMENTALE, con tutti gli articoli raggruppati per famiglie ma con valenza grafica di articoli ed esempi applicati proporzionata all' "importanza commerciale media" di quel prodotto o linea di prodotti.

Ripetiamo: "importanza commerciale MEDIA" e ricordiamo che Ind.i.a. spa esporta in oltre 130 paesi.

Sarà uno strumento di grande utilità per tutti gli OPERATORI di settore.

ARTEFERRO *Compendium*

is a Latin origin word meaning "to weight together, or balance". It also means "compilation of a body of Knowledge". Not a simple "summary" than, but rather a guided lead to all that Ind.i.a. spa. can offer in the field of FENCING with WROUGHT IRON, STAINLESS STEEL, ORNAMENTAL METALS.

Of course all our products are grouped by families but with special graphics and dimensions proportional to their "AVERAGE Commercial weight". We have no doubts it's going to be a very useful tool for all professionals in the Wrought Iron & Stainless Steel sector.



CHI SIAMO - WHO WE ARE

Una realtà in continua crescita

- Sede a Malo-Vicenza (Italia)
- 5 Stabilimenti produttivi
- 64.000 m² coperti
- Oltre 1100 tra dipendenti e collaboratori (2008)
- Filiali con deposito in Francia, Svezia, Croazia, Brasile, USA (Houston -Texas, Miami - Florida), Russia, Polonia, Spagna, Ucraina, Romania, Argentina, Cile, e Messico
- 4.100 t./mese spedite
- 40 milioni di semilavorati venduti mediamente in un anno
- Oltre 2000 clienti grossisti in 136 stati nel mondo; presumibilmente 150 mila fabbricanti usano il nostro prodotto
- 133 Libri cataloghi 5100 pagine totali
- Oltre 32.000 pezzi diversi a stock e in computer molti dei quali brevettati
- Diversi C.A.D. disponibili, di cui uno disponibile sul Web



Leader di mercato

- Una leadership nei 5 continenti
- Una presenza in 136 Stati
- Una gamma di oltre 30 mila articoli

World market leader

- A 5 continents' leadership
- Exports to 136 countries
- A product range of over 30.000 items

Certificazione

Un sistema di qualità certificato ISO 9001 dal Dicembre 1999
Dal Gennaio 2003, certificazione ISO 9001:2000 (Vision) e da Febbraio 2006, Certificazione Ambientale ISO 14001

Certification

Quality certified since Dec. 1999
Quality certified 9000:2000 (Vision) since January 2003, and Environmental Certification ISO 14001 since February 2006

An ever growing presence

- Headquarters in Malo - Vicenza - Italy
 - 5 production sites totalling
 - 64.000 Sq. Mt. of warehousing and production.
 - Over 1100 employees (2008)
 - Subsidiarie with stocking facilities in France, Sweden, Croatia, Brazil, U.S.A. (Houston-Texas, Miami- Florida) Spain, Russia, Poland, Ukraine, Romania, Argentina, Chile and México
 - 4.100 Ton/month shipped
 - 40 million pieces of ready made wrought iron components sold per year
 - Over 2000 stockist customers served, in 136 different countries presumably 150.000 professional fabricators using our forgings during a year
 - 13 catalogs-books for a total of 5100 pages
 - Over 32.000 components available in catalogs
 - computer and inventory
- Among our many CADs, one is available on the Web





Ex Macto

LE NOSTRE DITTE ALL'ESTERO



indital
industria italiana arteferro
HOUSTON - U.S.A.

7947 MESA ROAD - HOUSTON
TEXAS 77028 - U.S.A.
PHONE: (+1) (713) 694-6065 / 1-800-772-4706
FAX: (+1) (713) 694-2055
www.indital.com - forgings@indital.com



industria italiana arteferro
MIAMI - U.S.A.

2955 N.W. 75th STREET
MIAMI, FLORIDA 33147 - USA
PHONE: (+1) (305) 836-9232 / 1-877-723-6743
FAX: (+1) (305) 836-4113
www.arteferromiami.com info@arteferromiami.com



industria italiana arteferrosud
AVELLINO - ITALY

Via Piano Alvanella 83024 MONTEFORTE IRPINO (AV)
Tel. (+39) 0825 68 00 81
Fax (+39) 0825 68 34 98
(Per Campania - Puglia - Calabria - Basilicata - Molise)
www.arteferrosud.it-info@arteferrosud.it



ind.i.a.
industria italiana arteferro
SPAIN

28500 ARGANDA DEL REY (MADRID) - ESPAÑA
C/ ABEDUL, 43 - Polígono "EL GUIJAR"
TEL. (+34) (91) 8701897 - 8700819
FAX (+34) (91) 8700820
info@arteferro.es www.arteferro.es



ind.i.a.
industria italiana arteferro
FRANCE

Z.A.E. LA BAUME RN 113 - 34290 SERVIAN FRANCE
TEL. (+33) (0) 4.67.39.42.81 (lignes groupées)
Fax (+33) (0) 4.67.39.20.90
www.franceindia.com
france.india@wanadoo.fr



industria italiana arteferro
ROMANIA

Targoviste - Romania - Soseaua Gaesti, (sat Colanu)
Judetul Dambovita
Tel. (004) 0751060204, (004)0745395590
Fax (004)0745731210
E-mail: info@mobilforge.com



industria italiana arteferro dohomont
CROATIA

SIRKOVISCE bb 40324 GORICAN - HRVATSKA
PHONE (+385) (0)40 602 - 222
Fax PHONE (+385) (0)40 602-230
www.arteferro-dohomont.hr
info@arteferro-dohomont.hr



industria italiana arteferro
РОССИЯ

603092 Nizhny Novgorod (Russia)
Moskovskoye shosse, 320 B
TEL. (+7) (831) 296-19-99 FAX: (+7) (831) 279-28-63
www.arteferro.ru - www.arteferrorussia.com
info@arteferrorussia.com



ind.i.a.
industria italiana arteferro



Bonum

OUR COMPANIES ABROAD



ind.i.a.^{S.P.A.}
industria italiana arteferro
POLAND

ul. Gierdziejewskiego 7
02-495 Warszawa POLAND
Tel +48 (22) 397-79-40
Fax +48 (22) 397-21-55
info@indiapoland.com - www.indiapoland.com



industria italiana
arteferro
UKRAINE

5, AVTOPARKOVA, 02660 Kiev - Ukraine
Tel.: (+38) (044) 4920331
Fax: (+38) (044) 4920332
E-mail: arteferroukraine@svitonline.com
www.arteferroukraine.com



ind.i.a.^{S.P.A.}
industria italiana arteferro
BRASIL

RUA PADRE FEIJÓ, 480 CEP 95190-000
SÃO MARCOS / RS BRASIL
TEL. - FAX (+55) (0) 54 32911416
www.arteferrobrazil.com.br
arteferro@arteferrobrazil.com.br



industria italiana
arteferro
MEXICO

Av. E. Martínez Lara # 117 Parque Industrial MILIMEX
Carretera Sta. Rosa Km. 3 Apodaca,
Nuevo León C.P. 66637
Teléfono: (81) 1295-5094 / 1295-5095 - Fax: (81) 1295-5097
info@arteferromonterrey.com www.arteferromonterrey.com

VIA VICENZA, 6/14

36034 MALO

(VICENZA) ITALY

TEL. (+39) 0445 580 580

FAX (+39) 0445 580 874

E-mail: india@arteferro.com

www.arteferro.com

www.arteferroidox.com

www.ilgrandefabbro.com

www.ironews.com



industria italiana
arteferro
ARGENTINA

Suarez 760
(1162) Capital Federal Buenos Aires
Republica Argentina
TEL./Fax (+54) 11 43012637
www.laherreria.com



industria italiana
arteferro
CHILE

LOS ARRAYANES 250,
COMUNA DE COLINA,
SANTIAGO DE CHILE
TEL./FAX (+56) 2 738 7419
www.arteferrochile.cl



arteferro
ARTEFERRO INOX^{A B}
S K A N D I N A V I E N













BRODALSVÄGEN 7 HUS X 433 38
PARTILLE - SWEDEN
TEL. +46 (0) 31 444060 - FAX. +46 (0) 31 444511
www.arteferroidox.se
info@arteferroidox.se



Brevettato nei 25 paesi
della Comunità Europea
ed altrove.

Patented in all 25 E.C.
Countries and elsewhere.

INDICE - INDEX

1-12		Introduzione Introduction
13-44		Ricci Scrolls
45-52		Cerchi Rings
53-72		Rosoni Rosettes
73-76		Snap - Ons
77-120		Pannelli Panels
121-208		Paletti Pickets
209-220		Paletti verniciati Powder coated pickets
221-232		Caposaldi Newel posts
233-268		Corrimano e Barre lunghe Handrail and Long bars
269-286		Barre sagomate Shaped bars
287-296		Ricci grandi Big scrolls
297-320		Barre forate Pierced bars

321-348



Paletti per recinzione
Pickets for fencing

349-358



Cimase
Overthrows

359-376



Borchie e Pigne
Bushes and Baskets

377-380



Terminali a colonna
Column terminals

381-384



Sfere
Spheres

385-400



Lance
Spear points

401-408



Pomoli e Piastre
Top and Plates

409-440



Fiori e Ornamenti
Flowers and Ornaments

441-494



Elementi vari
Various elements

495-518



Ottone e Bronzo
Brass and Bronze

519-540



Alluminio
Aluminium

541-554



FORGINOX

555-588



ARTEFERRO INOX

589-596



Cataloghi
Catalogues

IND.I.A È ESPERIENZA !!

IND.I.A. MEANS EXPERIENCE



✓ **Ind.i.a (industria italiana arteferro)** è da ormai 40 anni leader mondiale nella produzione e commercializzazione di semilavorati ornamentali per l'edilizia e l'architettura. Sempre pronti all'uso ed alla consegna, nei nostri cataloghi troverete oltre 30.000 manufatti per recinzioni ed arredamento. I nostri fucinati artistici sono tutti frutto di ore di studi attenti ed appassionati da parte di professionisti specializzati che conoscono il settore meglio di chiunque altro in quanto l'abbiamo inventato noi.

✓ L'esperienza maturata in 40 anni di Ferro Battuto, ci ha consentito negli ultimi 10 anni di sviluppare un'altrettanto approfondita conoscenza dell'Acciaio Inox e dei suoi utilizzi nella recinzione. La nostra Linea ARTEFERRO INOX, infatti, pur essendo più tecnica e stilizzata rispetto ai manufatti in Ferro Battuto, assolve a quelle stesse esigenze di protezione, sostegno e decorazione che ben conosciamo da sempre.

✓ Grazie alla nostra esperienza pluridecennale, siamo gli unici al mondo capaci di realizzare Grandi Opere, forti del know how e della praticità dei nostri progettisti e operatori.

✓ Since 1971, Ind.i.a (industria italiana arteferro) is world leader in the production and sale of ornamental components for the building industry and Architecture. In our catalogues you will find more than 30.000 fencing and furniture components always ready to use and ready to be dispatched. All our artistic forged items are the result of years and years of careful and passionate research by qualified experts that know the field better than anyone else. As a matter of fact, we invented it.

✓ The experience acquired in 40 years of work in the field of Wrought Iron allowed us to develop in the last 10 years the same deep knowledge in the field of stainless steel and of its fencing application. As a matter of fact, our ARTEFERRO INOX line, while being more technical and stylized compared to the Wrought Iron components, meets the same needs of safety, support and decoration that we have always well known.

✓ Thanks to our long experience, we are the sole company in the world who is able to realize and install big structures, relying upon our know how and the practical sense of our designers and members of our team.



IND.I.A. È QUALITÀ !!

IND.I.A. MEANS QUALITY

✓ design funzionale: studiamo il design dei nostri prodotti in modo che possa essere sempre al passo con i tempi e che faciliti l'installazione

✓ functional design: we conceive the design of our products so that it is always abreast of the times and it makes the installation easier



✓ resistenza testata: vogliamo essere sicuri che i nostri sistemi siano all'altezza dell'utilizzo che andranno a svolgere. Per questo effettuiamo tests di resistenza a intemperie e sollecitazioni fisiche

✓ tested endurance: we want to be sure that our systems are up to their function. That is why we carry out endurance tests to weather conditions and physical stress



✓ perché è certificata: sono ormai 10 anni che abbiamo ottenuto la Certificazione di **Qualità ISO 9001** che anno dopo anno ci permette di monitorare i processi aziendali e innalzare ulteriormente la già altissima qualità dei prodotti e dei servizi offerti.

✓ perché siamo amici dell'Ambiente che ci circonda. Dal 2006 siamo certificati secondo la norma **ISO 14001** che ci insegna a produrre in un ambiente più salubre.

✓ certification: we obtained the ISO 9001 Quality Certification about 10 years ago. Such certification enables us to monitor the company processes and to further increase the already high quality of our products and the services that we offer.

✓ environment friendly: we are friends of the environment that surrounds us. Since 2006 we are certified according to the ISO 14001 standards that teach us to produce in a healthier environment.

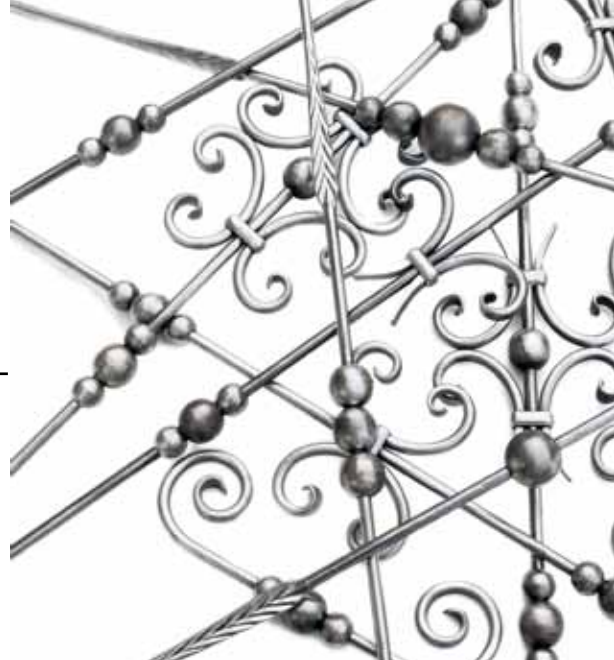

✓ flessibilità: crediamo che i prodotti debbano essere facili da assemblare e facili da integrare con gli altri elementi architettonici. Inoltre devono potersi adattare all'ambiente in cui verranno installati con la massima flessibilità

✓ flexibility: we believe that our products must be easy to assemble and to integrate with the other architectural elements. Furthermore, they must be able to fit with extreme flexibility in the environment in which they will be installed.



✓ controllo: i nostri prodotti sono testati qualitativamente prima, durante e dopo la produzione da personale esperto e specializzato. In fase di imballaggio vengono ulteriormente verificate le dimensioni la finitura e la fattezza di ogni prodotto

✓ control: our products are qualitatively tested before, during and after production by qualified experts. During the packing phase we check once again the sizes, the finishing and the shape of every products.

ISO 14001



ISO 9001



IND.I.A. È SERVIZIO !!

IND.I.A. MEANS SERVICE



- ✓ rispondiamo in tempo reale sulle scorte di magazzino ed ordini pervenuti
- ✓ we deliver in real time on the stock and on the orders placed by our customers



- ✓ da molti anni ormai realizziamo volantini e cataloghi personalizzati per i nostri clienti più affezionati
- ✓ we realize custom made leaflets and catalogues for our well-established customers



- ✓ disponiamo di un ufficio tecnico in grado di sviluppare appositamente per le vostre esigenze articoli su misura anche per quantitativi modesti
- ✓ our technical department can develop and assemble custom made products that will meet the needs of the customers even for small quantities



- ✓ possiamo anche sviluppare e montare progetti completi. Con il GRANDE FABBRO® - Servizio Chiavi in Mano!
- ✓ we can also develop full projects thanks to the GRANDE FABBRO® - turnkey service



- ✓ il nostro staff di back-office parla fluentemente cinque lingue diverse ed è specializzato nella gestione di pratiche export
- ✓ our back office staff speaks 5 different languages fluently and is qualified to handle export matters

- ✓ disponiamo del più grande stock mondiale
- ✓ we rely upon the biggest stock in the world



- ✓ accesso on line allo stock ed agli ordini on line
- ✓ we can grant on line access to the stock and the orders



- ✓ siamo presenti in tutto il mondo e disponiamo di filiali pronte a fornirvi i nostri articoli nel minore dei tempi e a supportarvi tecnicamente in qualsiasi momento.

- ✓ we rely upon branches that ensure our presence all over the world and that are ready to supply our products very quickly and to give technical support to our customers at any time



- ✓ consegnamo i nostri articoli a catalogo in 48 ore dall'ordine in tutto il mondo
siamo convenzionati con i più importanti Vettori Espressi per consegne celeri in tutto il mondo

- ✓ we dispatch the products in our catalogues all over the world within 48 hours from the receipt of the order
our agreements with the most important express carriers grant us quick deliveries all over the world



- ✓ essendo produttori forniamo i nostri articoli, anche quelli speciali in tempi brevissimi

- ✓ since we are "direc producers" we can deliver our products (even SPECIALS) very very quickly



IND.I.A. È ASSISTENZA !!

IND.I.A. MEANS ASSISTANCE



✓ tecnici specializzati sono a vostra disposizione per darvi informazioni e delucidazioni sull' uso e le applicazioni dei nostri prodotti

✓ qualified experts are at the disposal of the customers to provide them with articles of information and explanations of the use and the application of our products

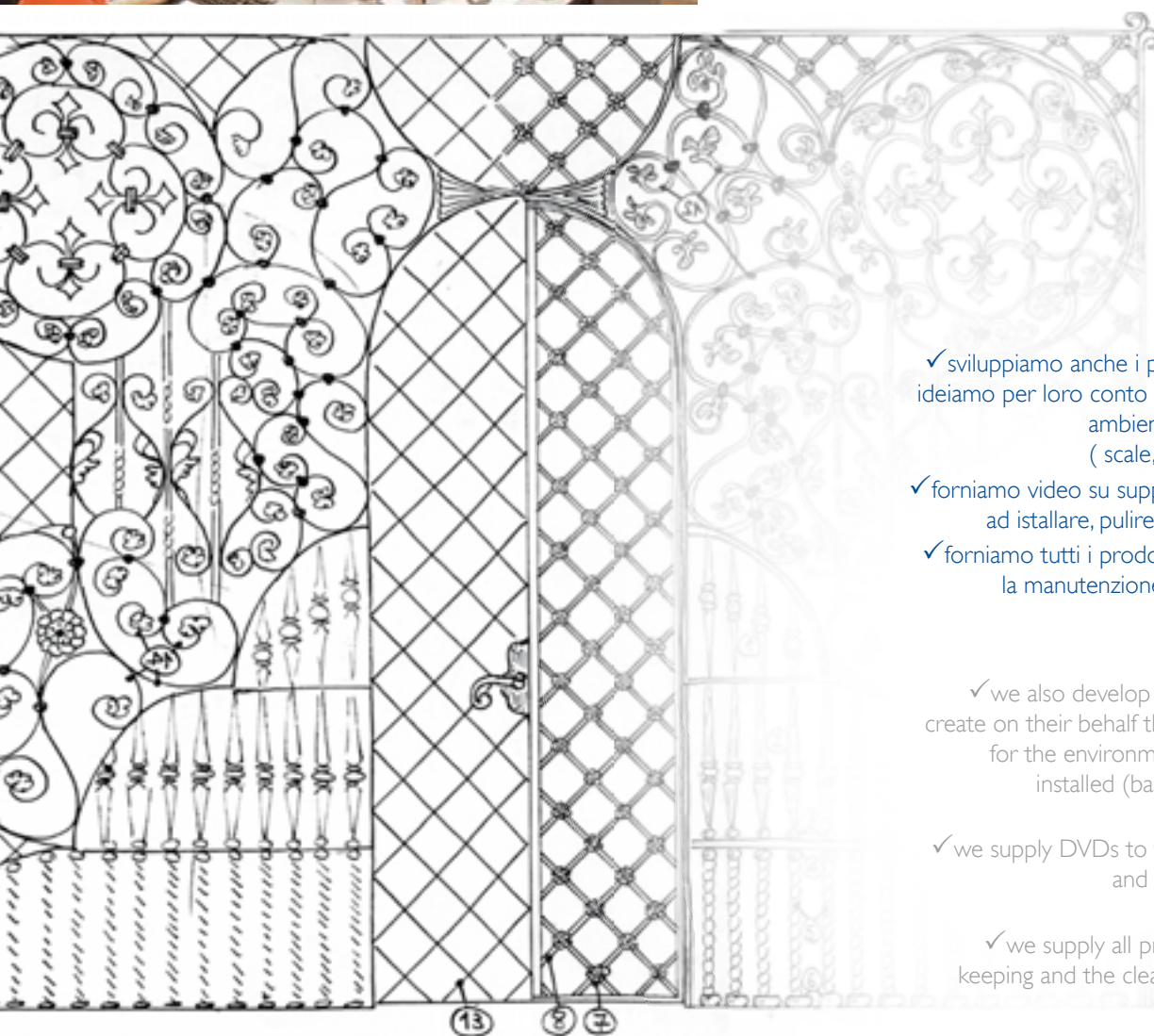

✓ sviluppiamo anche i progetti dei nostri clienti e ideiamo per loro conto le soluzioni più adatte agli ambienti in cui verranno installate (scale, parapetti , recinzioni ...)

✓ forniamo video su supporto DVD per insegnare ad installare, pulire e curare i nostri prodotti

✓ forniamo tutti i prodotti e vernici necessari per la manutenzione e pulizia del nostro inox

✓ we also develop our customers' plans and create on their behalf the most suitable solutions for the environments in which they will be installed (banisters, parapets, fences)

✓ we supply DVDs to teach how to install, clean and take care of our products

✓ we supply all products and paints for the keeping and the cleaning of our stainless steel

IND.I.A. PRODUCE DAVVERO !!

IND.I.A. MEANS REAL PRODUCTION



✓ ...te lo dicono i nostri articoli. Su ogni prodotto è stampigliato il nostro logo, il codice articolo e il materiale con cui è stato realizzato, a garanzia dei processi qualitativi sottostanti.

✓ I nostri articoli, a differenza della gran parte di prodotti che si trovano sul mercato, sono realizzati nei nostri Centri Produttivi in Italia ed Europa, sottostando a canoni di produzione e a test qualitativi standard che ci consentono di conoscere la vita di ogni pezzo dalla sua nascita alla sua consegna.

A differenza di molti altri noi siamo davvero produttori (con 5 stabilimenti produttivi in Italia ed Europa). Siamo l'unica azienda del settore che può vantare una capacità produttiva in grado di soddisfare ogni tua richiesta speciale entro tempi di stretta produzione (circa 10 giorni lavorativi).

✓ Per questo garantiamo i nostri prodotti da sempre (qualità e servizio); siamo noi a farli! E ci teniamo così tanto che ci mettiamo addirittura la firma



✓ our products say so. Each item shows our logo, the code and the material used for its production, in order to guarantee the underlying quality processes

✓ unlike most of the products on the market, our items are realized in our production branches in Italy and Europe, thus being submitted to production rules and standard quality tests that allow us to know the story of each piece from its birth to its delivery

✓ Unlike many of our competitors, we are real producers thanks to our 5 production branches in Italy and Europe. We are the sole company in the field that can boast a production capacity that manages satisfy every request of the customers within short production terms (about 10 working days)

✓ We have always guaranteed our products (quality and service) because we produce them! We care so much that we even shown our logo!

IND.I.A. È CONVENIENTE !!

IND.I.A. MEANS CONVENIENCE

- ✓ perchè siamo in grado di produrre esattamente su misura ciò di cui hai "veramente" bisogno.
- ✓ perchè abbiamo uno stock impressionante di articoli standard pronti da spedire anche senza obbligo di acquistare containers.
- ✓ perchè le grosse quantità che abbiamo ci consentono economie di scala sulla materia prima

- ✓ Il prezzo applicato è quello del produttore, non soggetto a ricariche dovute alla presenza di intermediari distributivi. Un prezzo di Fabbrica!!
- ✓ Le vostre scorte di magazzino le facciamo noi. Il nostro deposito diventa il "vostro" deposito.

- ✓ we can realize custom-made products upon the real needs of the customers
- ✓ we have a huge stock of standard items ready to be dispatched also in smaller quantities
- ✓ we can mantein good prices in purchasing on the raw material thanks to our big volumes
- ✓ we apply the producer cost, without any price rise due to the presence of other intermediaries in the distribution. Our price is a cost price!
- ✓ thanks to our stock, we can act as your stock too. Our inventory can become "your inventory"





RICCI - SCROLLS

COMPENDIUM 2011

Art. 687/3

TERMINALI
BATTUTI A CALDO



HOT FORGED
ENDS



SEZIONE - SECTION	H 270 mm L 110 mm Cod.art./Art.no.	H 110 mm L 60 mm Cod.art./Art.no.	H 150 mm L 110 mm Cod.art./Art.no.
∅ 12 x 6 mm	80/A/1	80/A/3	80/A/13
∅ 14 x 6 mm	80/A/28	80/A/29	80/A/30
∅ 16 x 4 mm	80/A/21	80/A/22	80/A/23
∅ 16 x 6 mm	80/A/14	80/A/15	80/A/16

TERMINALI
TRANCIATI A FREDDO

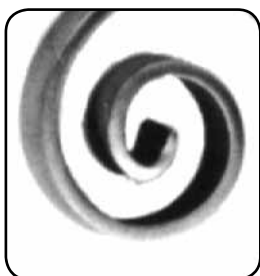

END PIECES COLD CUT



SEZIONE SECTION	H 360 mm L 120 mm Cod.art./Art.no.	H 360 mm L 120 mm Cod.art./Art.no.	H 290 mm L 120 mm Cod.art./Art.no.	H 220 mm L 108 mm Cod.art./Art.no.
∅ 8 x 8 mm	74/6	74/12	74/18	74/24
∅ 10 x 5 mm	74/1	74/7	74/13	74/19
∅ 12 x 6 mm	74/2	74/8	74/14	74/20
∅ 14 x 6 mm	74/25	74/27	74/26	74/28
∅ 16 x 4 mm	74/3	74/9	74/15	74/21
∅ 20 x 4 mm	74/4	74/10	74/16	74/22
∅ 20 x 6 mm	74/5	74/11	74/17	74/23

TERMINALI
BATTUTI A CALDO

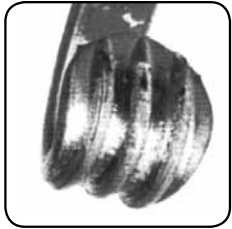

HOT FORGED
ENDS



SEZIONE SECTION	H 150 mm L 75 mm Cod.art./Art.no.	H 130 mm L 75 mm Cod.art./Art.no.	H 160 mm L 75 mm Cod.art./Art.no.	H 180 mm L 80 mm Cod.art./Art.no.	H 270 mm L 120 mm Cod.art./Art.no.	H 360 mm L 125 mm Cod.art./Art.no.
∅ 10 × 10 mm	-	-	-	-	88/H/1	-
∅ 12 × 6 mm	88/H/2	88/H/3	88/H/4	-	-	-
∅ 20 × 4 mm	-	-	-	88/H/6	-	88/H/5

TERMINALI
BATTUTI A CALDO

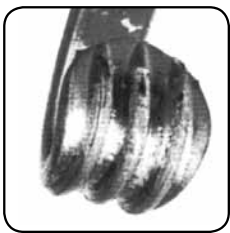

HOT FORGED
ENDS



SEZIONE SECTION	H 105 mm L 70 mm Cod.art./Art.no.	H 120 mm L 75 mm Cod.art./Art.no.	H 140 mm L 95 mm Cod.art./Art.no.	H 150 mm L 65 mm Cod.art./Art.no.	H 190 mm L 70 mm Cod.art./Art.no.
∅ 12 × 6 mm	80/A/9	80/B/8	80/A/10	80/A/11	80/A/12
∅ 14 × 6 mm	80/A/24	-	80/A/25	80/A/26	80/A/27
∅ 16 × 4 mm	80/A/17	80/B/3	80/A/18	80/A/19	80/A/20



ARTEFERRO

**TERMINALI
BATTUTI A CALDO**



**HOT FORGED
ENDS**



SEZIONE SECTION	H 95 mm L 65 mm Cod.art./Art.no.	H 110 mm L 70 mm Cod.art./Art.no.	H 120 mm L 60 mm Cod.art./Art.no.	H 130 mm L 80 mm Cod.art./Art.no.	H 145 mm L 80 mm Cod.art./Art.no.
∅ 12 x 6 mm	80/C/8	80/C/7	80/C/9	80/C/10	80/C/11
∅ 14 x 6 mm	80/C/18	80/C/17	80/C/19	80/C/20	80/C/21

**TERMINALI
BATTUTI A CALDO**



**HOT FORGED
ENDS**



SEZIONE SECTION	H 210 mm L 130 mm Cod.art./Art.no.	H 190 mm L 80 mm Cod.art./Art.no.	H 260 mm L 100 mm Cod.art./Art.no.	H 260 mm L 65 mm Cod.art./Art.no.	H 290 mm L 80 mm Cod.art./Art.no.
∅ 12 x 6 mm	80/C/12	80/C/14	80/C/13	80/C/16	80/C/15
∅ 14 x 6 mm	80/C/22	80/C/24	80/C/23	80/C/26	80/C/25

**TERMINALI
TRANCIATI A FREDDO**



END PIECES COLD CUT



SEZIONE SECTION	H 115 mm L 60 mm Cod.art./Art.no.	H 180 mm L 90 mm Cod.art./Art.no.
∅ 8 x 8 mm	78/6	78/12
∅ 10 x 5 mm	78/1	78/7
∅ 12 x 6 mm	78/2	78/8
∅ 14 x 6 mm	78/14	78/13
∅ 16 x 4 mm	78/3	78/9
∅ 20 x 4 mm	78/4	78/10
∅ 20 x 6 mm	78/5	78/11
∅ 30 x 8 mm	78/15	



ARTEFERRO

Art. GD264/4

∅ 14 x 8 mm
H 390 mm
L 120 mm



Art. GD264/3

∅ 14 x 8 mm
H 500 mm
L 115 mm



Art. GD264/2

∅ 14 x 8 mm
H 560 mm
L 315 mm



Art. GD264/1

∅ 14 x 8 mm
H 710 mm
L 370 mm



TERMINALI
BATTUTI A CALDO

HOT FORGED
ENDS



ARTEFERRO

Art. GD264/5

∅ 14 x 8 mm
H 180 mm
L 75 mm



Art. GD240/2

∅ 14 x 8 mm
H 320 mm
L 200 mm

RICCI - SCROLLS



Art. GD262/3
 ∅ 14 x 8 mm
 H 230 mm
 L 100 mm



Art. GD262/4
 ∅ 14 x 8 mm
 H 240 mm
 L 100 mm



Art. GD263/2
 ∅ 14 x 8 mm
 H 220 mm
 L 100 mm



Art. GD263/3
 ∅ 14 x 8 mm
 H 220 mm
 L 100 mm



Art. GD263/1
 ∅ 14 x 8 mm
 H 270 mm
 L 95 mm



Art. GD262/2
 ∅ 14 x 8 mm
 H 215 mm
 L 110 mm



Art. GD262/1
 ∅ 14 x 8 mm
 H 200 mm
 L 105 mm

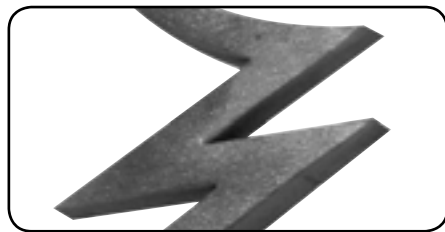

TERMINALI
 AVVOLTI A CALDO
 HOT ROLLED UP
 ENDS



ARTEFERRO



Art. 87/6
 ∅ 12 x 6 mm
 H 150 mm
 L 80 mm

Art. 87/5
 ∅ 12 x 6 mm
 H 160 mm
 L 90 mm



Art. 88/9
 ∅ 12 x 6 mm
 H 250 mm
 L 125 mm



Art. 87/1
 ∅ 12 x 6 mm
 H 130 mm
 L 80 mm



Art. 88/10
 ∅ 12 x 6 mm
 H 123 mm
 L 73 mm



Art. 88/A/3
 ∅ 12 x 6 mm
 H 110 mm
 L 70 mm

**RICCI
 STAMPATI A FREDDO
 COLD STAMPED
 SCROLL**



Art. 86/5
 ∅ 12 x 6 mm
 H 210 mm
 L 95 mm



Art. 90/1
 ∅ 10 x 5 mm
 H 180 mm
 L 155 mm



Art. 81/3
 ∅ 8 x 8 mm
 H 122 mm
 L 73 mm



Art. 81/5
 ∅ 8 x 8 mm
 H 122 mm
 L 73 mm

ARTEFERRO



SEZIONE SECTION	H 175 mm L 165 mm Cod.art./Art.no.	H 220 mm L 105 mm Cod.art./Art.no.	H 150 mm L 95 mm Cod.art./Art.no.	H 220 mm L 105 mm Cod.art./Art.no.	H 300 mm L 105 mm Cod.art./Art.no.
Φ 12 x 12 mm	94/P/5	94/Q/1	94/Q/5	94/P/1	94/P/9
Φ 14 x 14 mm	94/P/6	94/Q/2	94/Q/6	94/P/2	94/P/10



Φ 12 x 12 mm	94/P/7	94/Q/3	94/Q/7	94/P/3	94/P/11
Φ 14 x 14 mm	94/P/8	94/Q/4	94/Q/8	94/P/4	94/P/12



ARTEFERRO



Art. 1046/3
Φ 12 x 12 mm
H 455 mm
L 240 mm



Art. 1046/5
Φ 12 x 12 mm
H 445 mm
L 180 mm



Art. 1046/7
Φ 12 x 12 mm
H 105 mm
L 65 mm

Art. 1046/6
Φ 12 x 12 mm
H 160 mm
L 110 mm



Art. 1046/4
Φ 12 x 12 mm
H 320 mm
L 185 mm

TERMINALI
AVVOLTI A CALDO



HOT ROLLED UP
ENDS



SEZIONE SECTION	H 360 mm L 120 mm Cod.art./Art.no.	H 360 mm L 120 mm Cod.art./Art.no.	H 290 mm L 120 mm Cod.art./Art.no.	H 220 mm L 120 mm Cod.art./Art.no.	H 255 mm L 115 mm Cod.art./Art.no.
Ø 12 mm	1295/1	1295/2	1295/3	1295/4	1295/5
∇ 16 x 4 mm	1294/1	1294/2	1294/3	1294/4	-



TERMINALI
AVVOLTI A CALDO



HOT ROLLED UP
ENDS



SEZIONE SECTION	H 115 mm L 60 mm Cod.art./Art.no.	H 180 mm L 90 mm Cod.art./Art.no.	H 350 mm L 120 mm Cod.art./Art.no.	H 210 mm L 120 mm Cod.art./Art.no.	H 220 mm L 70 mm Cod.art./Art.no.
Ø/dia 12 mm	1295/7	1295/6	-	-	-
∇ 16 x 4 mm	1294/9	1294/8	1294/6	1294/7	1294/5



Art. 1301/1
 ∅ 14 x 8 mm
 H 390 mm
 L 120 mm



Art. 1301/2
 ∅ 14 x 8 mm
 H 330 mm
 L 120 mm



Art. 1301/3
 ∅ 14 x 8 mm
 H 280 mm
 L 120 mm



Art. 1301/4
 ∅ 14 x 8 mm
 H 280 mm
 L 120 mm



Art. 1301/5
 ∅ 14 x 8 mm
 H 220 mm
 L 100 mm



Art. 1301/6
 ∅ 14 x 8 mm
 H 325 mm
 L 120 mm



Art. 1301/7
 ∅ 14 x 8 mm
 H 260 mm
 L 120 mm



Art. 1301/8
 ∅ 14 x 8 mm
 H 160 mm
 L 100 mm



Art. 1301/9
 ∅ 14 x 8 mm
 H 210 mm
 L 100 mm



Art. 1301/10
 ∅ 14 x 8 mm
 H 130 mm
 L 70 mm

**TERMINALI
 AVVOLTI A CALDO**



**HOT ROLLED UP
 ENDS**



Art. NEW0069
 ∅ 12 x 6 mm
 H 360 mm
 L 120 mm



Art. NEW0070
 ∅ 12 x 6 mm
 H 360 mm
 L 120 mm



Art. NEW0073
 ∅ 12 x 6 mm
 H 240 mm
 L 115 mm



Art. NEW0074
 ∅ 12 x 6 mm
 H 220 mm
 L 120 mm



Art. NEW0063
 ∅ 12 x 6 mm
 H 260 mm
 L 100 mm



Art. NEW0065
 ∅ 12 x 6 mm
 H 180 mm
 L 85 mm



Art. NEW0066
 ∅ 12 x 6 mm
 H 140 mm
 L 90 mm

Art. NEW0072
 ∅ 12 x 6 mm
 H 260 mm
 L 95 mm

Art. NEW0071
 ∅ 12 x 6 mm
 H 290 mm
 L 120 mm

Art. NEW0064
 ∅ 12 x 6 mm
 H 180 mm
 L 100 mm

Art. NEW0068
 ∅ 12 x 6 mm
 H 115 mm
 L 55 mm

Art. NEW0067
 ∅ 12 x 6 mm
 H 115 mm
 L 70 mm



Art. 1296/1
 □ 12 x 6 mm
 H 360 mm
 L 120 mm



Art. 1296/2
 □ 12 x 6 mm
 H 360 mm
 L 120 mm



Art. 1296/3
 □ 12 x 6 mm
 H 290 mm
 L 120 mm



Art. 1296/4
 □ 12 x 6 mm
 H 220 mm
 L 120 mm



Art. 623/1
 □ 12 x 6 mm
 L 3000 mm



Art. 1296/5
 □ 12 x 6 mm
 H 180 mm
 L 90 mm



Art. 1296/6
 □ 12 x 6 mm
 H 115 mm
 L 60 mm



Art. 1296/7
 □ 12 x 6 mm
 H 140 mm
 L 90 mm



Art. 1296/8
 □ 12 x 6 mm
 H 115 mm
 L 70 mm

**TERMINALI
 AVVOLTI A CALDO**



**HOT ROLLED UP
 ENDS**



Art. 1296/12
 Ø 12 mm
 H 135 mm
 L 90 mm



Art. 1296/13
 Ø 12 mm
 H 110 mm
 L 70 mm



Art. 1296/9
 Ø 12 mm
 H 260 mm
 L 120 mm



Art. 1296/10
 Ø 12 mm
 H 260 mm
 L 95 mm



Art. 1296/11
 Ø 12 mm
 H 260 mm
 L 100 mm



Art. 600/4
 Ø 12 mm
 L 3000 mm

**RICCI
SAGOMATO A FREDDO**

**COLD SHAPED
SCROLLS**



Art. 641/1
 \varnothing 12 x 6 mm
 H 105 mm
 L 70 mm



Art. 641/2
 \varnothing 12 x 6 mm
 H 130 mm
 L 70 mm



Art. 641/3
 \varnothing 12 x 6 mm
 H 115 mm
 L 60 mm



Art. 641/4
 \varnothing 12 x 6 mm
 H 180 mm
 L 90 mm



Art. 641/7
 \varnothing 12 x 6 mm
 H 360 mm
 L 120 mm



Art. 641/8
 \varnothing 12 x 6 mm
 H 360 mm
 L 120 mm



Art. 641/6
 \varnothing 12 x 6 mm
 H 290 mm
 L 120 mm



Art. 641/5
 \varnothing 12 x 6 mm
 H 220 mm
 L 120 mm



Art. 623/1



ARTEFERRO



TERMINALI FUCINATI A CALDO

HOT FORGED ENDS



Art. 88/P/1
 \varnothing 14 x 8 mm
 H 290 mm
 L 130 mm



Art. 88/P/3
 \varnothing 14 x 8 mm
 H 130 mm
 L 80 mm



Art. 88/G/3
 \varnothing 10 x 10 mm
 H 130 mm
 L 65 mm



Art. 88/P/2
 \varnothing 14 x 8 mm
 H 160 mm
 L 80 mm



Art. 78/B/1
 \varnothing 12 x 12 mm
 H 220 mm
 L 110 mm



Art. 78/B/2
 \varnothing 12 x 12 mm
 H 220 mm
 L 110 mm



Art. 78/B/3
 \varnothing 12 x 12 mm
 H 300 mm
 L 110 mm

Art. 6036/8
 \varnothing 14 mm
 H 160 mm
 L 80 mm

Art. 78/B/4
 \varnothing 14 x 14 mm
 H 220 mm
 L 110 mm

Art. 78/B/5
 \varnothing 14 x 14 mm
 H 220 mm
 L 110 mm

Art. 78/B/6
 \varnothing 14 x 14 mm
 H 300 mm
 L 110 mm



Art. NEW0061

Ø 16 x 6 mm
H 260 mm
L 125 mm



Art. NEW0062

Ø 16 x 6 mm
H 190 mm
L 70 mm



Art. NEW0012

Ø 16 x 6 mm
H 260 mm
L 130 mm



Art. NEW0060

Ø 16 x 6 mm
H 350 mm
L 130 mm



ARTEFERRO



Art. 1297/1

Ø 10 mm
H 360 mm
L 120 mm



Art. 1297/2

Ø 10 mm
H 360 mm
L 120 mm



Art. 1297/3

Ø 10 mm
H 290 mm
L 120 mm



Art. 1297/4

Ø 10 mm
H 220 mm
L 120 mm



Art. 1297/5

Ø 10 mm
H 220 mm
L 120 mm



Art. 1297/6

Ø 10 mm
H 180 mm
L 90 mm



Art. 1297/7

Ø 10 mm
H 120 mm
L 60 mm

TERMINALI FUCINATI
A CALDO
HOT FORGED
ENDS



Art. 1297/8

Ø 10 x 10 mm
H 360 mm
L 120 mm



Art. 1297/9

Ø 10 x 10 mm
H 360 mm
L 120 mm



Art. 1297/10

Ø 10 x 10 mm
H 290 mm
L 120 mm



Art. 1297/11

Ø 10 x 10 mm
H 220 mm
L 120 mm



Art. 1297/12

Ø 10 x 10 mm
H 220 mm
L 120 mm



Art. 1297/13

Ø 10 x 10 mm
H 180 mm
L 90 mm



Art. 1297/14

Ø 10 x 10 mm
H 120 mm
L 60 mm

RICCI - SCROLLS



Art. 1144/3
 Ø 12 x 12 mm
 H 350 mm
 L 145 mm



Art. 1144/5
 Ø 12 x 12 mm
 H 335 mm
 L 170 mm



Art. 1144/6
 Ø 12 x 12 mm
 H 270 mm
 L 160 mm



Art. 1144/4
 Ø 12 x 12 mm
 H 225 mm
 L 105 mm



Art. 1144/1
 Ø 12 x 12 mm
 H 215 mm
 L 120 mm



Art. 1144/2
 Ø 12 x 12 mm
 H 185 mm
 L 95 mm



Art. 1145/2
 Ø 12 x 12 mm
 H 180 mm
 L 135 mm

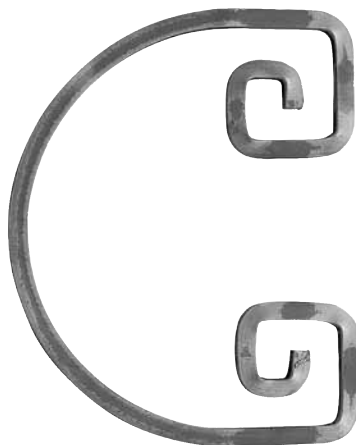

Art. 1145/1
 Ø 12 x 12 mm
 H 280 mm
 L 195 mm



Art. 1143/1
 Ø 12 x 12 mm
 H 190 mm
 L 215 mm



Art. 1143/2
 Ø 12 x 12 mm
 H 300 mm
 L 185 mm

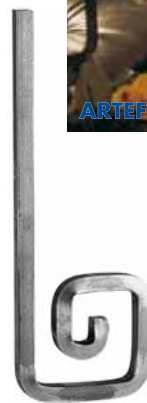

Art. 1143/3
 Ø 12 x 12 mm
 H 300 mm
 L 100 mm



Art. 1145/3
 Ø 12 x 12 mm
 H 315 mm
 L 170 mm



RICCI STAMPATI A FREDDO - COLD STAMPED SCROLL



Art. 73/1
 \varnothing 8 x 8 mm
 H 300 mm
 L 110 mm



Art. 73/2
 \varnothing 8 x 8 mm
 H 230 mm
 L 110 mm



Art. 38/5
 \varnothing 8 x 8 mm
 H 330 mm
 L 85 mm

Art. 38/7
 \varnothing 10 x 10 mm
 H 330 mm
 L 100 mm

Art. 38/8
 \varnothing 12 x 12 mm
 H 390 mm
 L 100 mm

Art. 38/6
 \square 12 x 6 mm
 H 330 mm
 L 85 mm



Art. 73/3
 \varnothing 8 x 8 mm
 H 180 mm
 L 90 mm



Art. 81/1
 \varnothing 8 x 8 mm
 H 115 mm
 L 85 mm



Art. 89/2
 \varnothing 8 x 8 mm
 H 115 mm
 L 125 mm

Art. 89/3
 \square 12 x 6 mm
 H 115 mm
 L 125 mm

TERMINALI BATTUTI A CALDO
 HOT FORGED ENDS



Art. 64/G/3
 \square 12 x 6 mm
 H 150 mm
 L 105 mm



Art. 64/G/4
 \square 12 x 6 mm
 H 105 mm
 L 60 mm



Art. 64/G/5
 \square 12 x 6 mm
 H 105 mm
 L 60 mm



Art. 64/G/6
 \square 12 x 6 mm
 H 230 mm
 L 50 mm

Art. 64/G/7
 \square 14 x 6 mm
 H 150 mm
 L 105 mm

Art. 64/G/8
 \square 14 x 6 mm
 H 105 mm
 L 60 mm

Art. 64/G/9
 \square 14 x 6 mm
 H 105 mm
 L 60 mm

Art. 64/G/10
 \square 14 x 6 mm
 H 230 mm
 L 50 mm





Art. 94/2
 ∅ 12 x 6 mm
 H 200 mm
 L 150 mm



Art. 92/B/4
 ∅ 12 x 6 mm
 H 250 mm
 L 160 mm



Art. 92/B/3
 ∅ 12 x 6 mm
 H 350 mm
 L 80 mm



Art. 93/4
 ∅ 12 x 6 mm
 H 350 mm
 L 230 mm



Art. 92/C/4
 ∅ 12 x 6 mm
 H 510 mm
 L 112 mm



Art. 92/C/5
 ∅ 12 x 6 mm
 H 510 mm
 L 112 mm

**RICCIO IN TUBO
TUBE STEEL SCROLL**

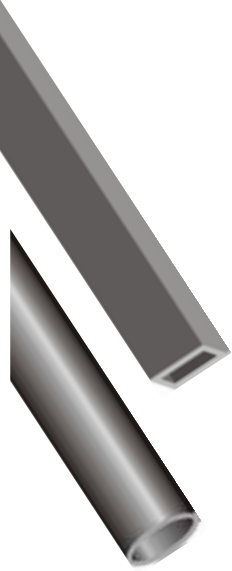

Art. 651/3
 ∅ 12 x 12 mm
 H 360 mm
 L 135 mm
Art. 650/2
 Ø 12 mm
 H 360 mm
 L 135 mm



Art. 651/4
 ∅ 12 x 12 mm
 H 380 mm
 L 130 mm
Art. 650/1
 Ø 12 mm
 H 380 mm
 L 130 mm



ARTEFERRO



Art. 651/2
 ∅ 12 x 12 mm
 H 255 mm
 L 135 mm
Art. 650/4
 Ø 12 mm
 H 255 mm
 L 135 mm



Art. 651/1
 ∅ 12 x 12 mm
 H 235 mm
 L 120 mm
Art. 650/3
 Ø 12 mm
 H 235 mm
 L 120 mm



ARTEFERRO

TERMINALI BATTUTI A CALDO
HOT FORGED ENDS



ARTEFERRO



Art. 88/A/1
∅ 12 x 6 mm
H 135 mm
L 60 mm



Art. 88/M/2
∅ 12 x 6 mm
H 125 mm
L 75 mm



Art. 658/8
∅ 12 x 12 mm
H 130 mm
L 65 mm



Art. 658/7
∅ 12 x 12 mm
H 130 mm
L 80 mm

Art. 659/11
∅ 12 mm
H 130 mm
L 65 mm

Art. 659/10
∅ 12 mm
H 130 mm
L 80 mm



Art. 88/4
∅ 12 x 6 mm
H 130 mm
L 90 mm



Art. 82/1
∅ 10 x 5 mm
H 125 mm
L 75 mm



Art. 82/7
∅ 20 x 4 mm
H 130 mm
L 72 mm



Art. 87/3
∅ 16 x 4 mm
H 120 mm
L 75 mm



Art. 81/7
∅ 8 x 8 mm
H 122 mm
L 73 mm

Art. 82/3
∅ 8 mm
H 120 mm
L 75 mm

Art. 82/5
∅ 10 mm
H 120 mm
L 75 mm

Art. 88/5
∅ 16 x 4 mm
H 130 mm
L 90 mm

Art. 88/6
∅ 20 x 4 mm
H 130 mm
L 90 mm

liscio/plain

Art. 75/21
∅ 20 x 4 mm
H 370 mm
L 170 mm

Art. 75/23
∅ 25 x 4 mm
H 370 mm
L 170 mm

Art. 75/25
∅ 30 x 5 mm
H 370 mm
L 170 mm

Art. 75/27
∅ 40 x 4 mm
H 370 mm
L 170 mm

Art. 75/29
∅ 50 x 4 mm
H 370 mm
L 170 mm

martellato/hammered

Art. 75/22
∅ 20 x 4 mm
H 370 mm
L 170 mm

Art. 75/24
∅ 25 x 4 mm
H 370 mm
L 170 mm

Art. 75/26
∅ 30 x 5 mm
H 370 mm
L 170 mm

Art. 75/28
∅ 40 x 4 mm
H 370 mm
L 170 mm

Art. 75/30
∅ 50 x 4 mm
H 370 mm
L 170 mm



Art. 84/7
∅ 20 x 6 mm
H 225 mm
L 150 mm



Art. 76/1
∅ 12 x 6 mm
H 320 mm
L 100 mm

Art. 76/2
∅ 16 x 4 mm
H 320 mm
L 100 mm

Art. 76/3
∅ 20 x 4 mm
H 320 mm
L 100 mm



Art. 94/C/8
 Ø 10 mm
 H 300 mm
 L 210 mm

Art. 94/C/7
 Ø 10 mm
 H 300 mm
 L 210 mm



Art. 94/C/4
 Ø 10 mm
 H 170 mm
 L 110 mm

Art. 94/C/3
 Ø 10 mm
 H 170 mm
 L 110 mm



Art. 94/C/6
 Ø 10 mm
 H 270 mm
 L 190 mm



Art. 94/C/5
 Ø 10 mm
 H 270 mm
 L 190 mm



Art. 94/C/2
 16 x 2,5 mm
 H 170 mm
 L 140 mm



Art. 94/C/1
 16 x 2,5 mm
 H 130 mm
 L 100 mm



Art. 92/B/2
 12 x 6 mm
 H 305 mm
 L 105 mm



Art. 92/B/1
 12 x 6 mm
 H 305 mm
 L 105 mm



Art. 92/D/1
 12 x 6 mm
 H 295 mm
 L 70 mm



Art. 92/D/2
 12 x 6 mm
 H 295 mm
 L 70 mm



Art. 92/D/5
 12 x 6 mm
 H 255 mm
 L 120 mm



Art. 656/2
 16 x 8 mm
 H 70 mm
 L 400 mm



Art. 656/3
 16 x 8 mm
 H 270 mm
 L 70 mm



Art. 656/4
 16 x 8 mm
 H 270 mm
 L 70 mm



Art. 52/H/2
 12 x 6 mm
 H 270 mm
 L 130 mm



Art. 52/H/1
 12 x 6 mm
 H 270 mm
 L 130 mm



Art. 94/1
 12 x 6 mm
 H 300 mm
 L 200 mm



Art. 94/3
 12 x 6 mm
 H 200 mm
 L 150 mm



Art. 93/2
 12 x 6 mm
 H 300 mm
 L 200 mm



Art. 658/6
 12 x 12 mm
 H 300 mm
 L 205 mm



Art. 659/6
 Ø 12 mm
 H 300 mm
 L 205 mm



Art. 93/1
 12 x 6 mm
 H 450 mm
 L 320 mm

Art. 93/3
 12 x 6 mm
 H 450 mm
 L 200 mm



ARTEFERRO



Art. 655/5
 ∅ 16 x 8 mm
 H 320 mm
 L 200 mm



Art. 655/4
 ∅ 16 x 8 mm
 H 320 mm
 L 200 mm



Art. 657/2
 ∅ 12 x 12 mm
 H 400 mm
 L 260 mm

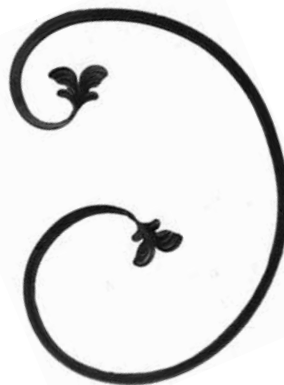

Art. 657/1
 ∅ 12 x 12 mm
 H 440 mm
 L 300 mm



Art. 458/1
 ∅ 14 x 14 mm
 H 210 mm
 L 300 mm



Art. 659/7
 ∅ 12 mm
 H 400 mm
 L 260 mm

Art. 659/9
 ∅ 12 mm
 H 440 mm
 L 300 mm

Art. 24/F/2
 ∅ 12 x 12 mm
 H 220 mm
 L 300 mm



Art. 657/3
 ∅ 12 x 12 mm
 H 430 mm
 L 260 mm



Art. 658/4
 ∅ 12 x 12 mm
 H 460 mm
 L 200 mm



Art. 688/8
 ∅ 12 mm
 H 280 mm
 L 210 mm

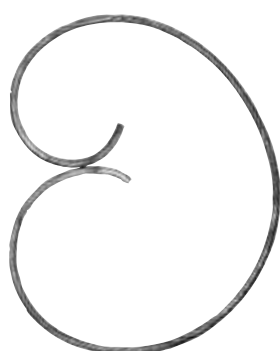

Art. 688/1
 ∅ 12 mm
 H 420 mm
 L 330 mm

Art. 659/8
 ∅ 12 mm
 H 430 mm
 L 260 mm

Art. 659/1
 ∅ 12 mm
 H 460 mm
 L 200 mm

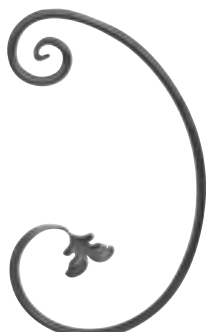

Art. 658/1
 ∅ 12 x 12 mm
 H 400 mm
 L 240 mm



Art. 658/3
 ∅ 12 x 12 mm
 H 300 mm
 L 210 mm



Art. 658/5
 ∅ 12 x 12 mm
 H 300 mm
 L 200 mm

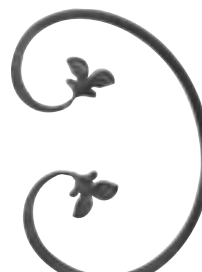

Art. 658/2
 ∅ 12 x 12 mm
 H 350 mm
 L 240 mm

Art. 659/2
 ∅ 12 mm
 H 400 mm
 L 240 mm

Art. 659/4
 ∅ 12 mm
 H 300 mm
 L 210 mm

Art. 659/5
 ∅ 12 mm
 H 300 mm
 L 200 mm

Art. 659/3
 ∅ 12 mm
 H 350 mm
 L 240 mm



ARTEFERRO

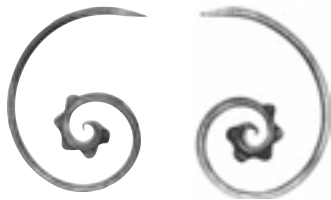

Art. 686/1
Ø 12 mm
H 110 mm
L 85 mm

Art. 686/4
Ø 12 mm
H 110 mm
L 85 mm

Art. 686/2
Ø 12 mm
H 130 mm
L 100 mm

Art. 686/5
Ø 12 mm
H 130 mm
L 100 mm

Art. 686/3
Ø 12 mm
H 170 mm
L 120 mm

Art. 686/6
Ø 12 mm
H 170 mm
L 120 mm

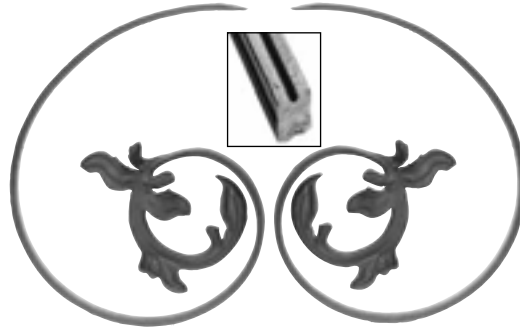

Art. 682/10
Ø 16 x 8 mm
H 400 mm
L 300 mm

Art. 682/11
Ø 16 x 8 mm
H 400 mm
L 300 mm

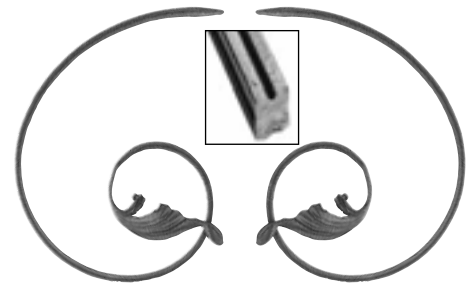

Art. 682/9
Ø 16 x 8 mm
H 330 mm
L 230 mm

Art. 682/8
Ø 16 x 8 mm
H 330 mm
L 230 mm

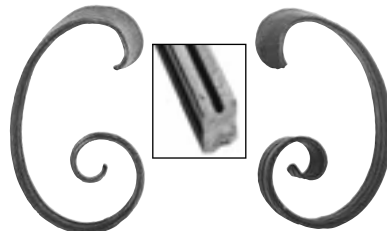

Art. 684/2
Ø 16 x 8 mm
H 160 mm
L 100 mm

Art. 684/1
Ø 16 x 8 mm
H 160 mm
L 100 mm



Art. 88/M/3
Ø 16 x 8 mm
H 215 mm
L 135 mm

Art. 683/1
Ø 16 x 8 mm
H 270 mm
L 220 mm

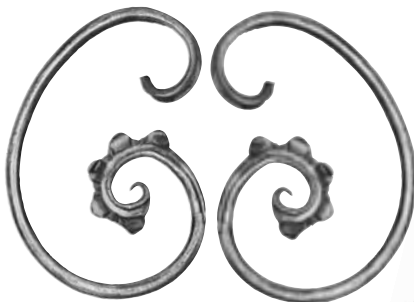

Art. 687/1
Ø 12 mm
H 230 mm
L 170 mm

Art. 687/2
Ø 12 mm
H 230 mm
L 170 mm



Art. 686/15
Ø 12 mm
H 120 mm
L 100 mm

Art. 686/16
Ø 12 mm
H 120 mm
L 100 mm

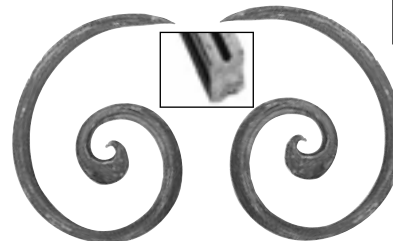

Art. 684/3
Ø 16 x 8 mm
H 170 mm
L 130 mm

Art. 684/4
Ø 16 x 8 mm
H 170 mm
L 130 mm



Art. 683/2
Ø 16 x 8 mm
H 270 mm
L 220 mm

Art. 683/3
Ø 16 x 8 mm
H 300 mm
L 240 mm



Art. 686/7
Ø 12 mm
H 240 mm
L 180 mm

Art. 686/8
Ø 12 mm
H 295 mm
L 210 mm



Art. 686/11
Ø 12 mm
H 240 mm
L 180 mm

Art. 686/12
Ø 12 mm
H 295 mm
L 210 mm



Art. 687/3
Ø 12 mm
H 170 mm
L 120 mm

Art. 687/6
Ø 12 mm
H 170 mm
L 120 mm

Art. 687/4
Ø 12 mm
H 185 mm
L 135 mm

Art. 687/7
Ø 12 mm
H 185 mm
L 135 mm

Art. 687/5
Ø 12 mm
H 235 mm
L 180 mm

Art. 687/8
Ø 12 mm
H 235 mm
L 180 mm



Art. 683/4
Ø 16 x 8 mm
H 300 mm
L 240 mm

Art. 686/9
Ø 12 mm
H 350 mm
L 270 mm

Art. 686/10
Ø 12 mm
H 430 mm
L 330 mm

Art. 686/13
Ø 12 mm
H 350 mm
L 240 mm

Art. 686/14
Ø 12 mm
H 430 mm
L 330 mm

Ø = diameter

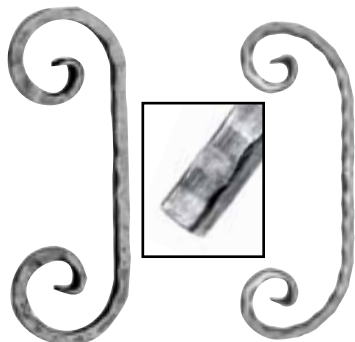

Art. 483/4

Φ 14 x 14 mm
H 300 mm
L 100 mm



Art. 634/3

Φ 12 x 12 mm
H 355 mm
L 135 mm



Art. 483/5

Φ 14 x 14 mm
H 200 mm
L 100 mm



Art. 630/3

∅ 20 x 10 mm
H 260 mm
L 115 mm



Art. 88/A/2

∅ 12 x 6 mm
H 145 mm
L 80 mm



Art. 88/N/4

∅ 12 x 6 mm
H 180 mm
L 90 mm

Art. 88/N/11

∅ 14 x 6 mm
H 180 mm
L 90 mm



borchia in tubo
steel tube bush

Art. 152/4

Ø 12 mm
H 250 mm
L 120 mm



Art. 642/3

Ø 10 mm
H 130 mm
L 270 mm



sfere vuote
hollow spheres

Art. 1212/1

Ø 12 mm
H 330 mm
L 95 mm



Art. 648/2

Ø 10 mm
H 270 mm
L 130 mm



Art. 1298/9

∅ 14 x 14 mm
H 450 mm
L 200 mm



Art. 1298/12

∅ 14 x 14 mm
H 280 mm
L 130 mm



Art. 1053/2

Ø 12 mm
H 270 mm
L 180 mm



Art. 1053/3

Ø 12 mm
H 270 mm
L 160 mm



Art. 88/E/4

Φ 10 x 10 mm
H 240 mm
L 120 mm



Art. 77/3

∅ 20 x 4 mm
H 360 mm
L 115 mm



Art. 77/6

∅ 20 x 4 mm
H 450 mm
L 115 mm

Art. 77/4

∅ 25 x 4 mm
H 360 mm
L 115 mm

Art. 77/7

∅ 25 x 4 mm
H 450 mm
L 115 mm

Art. 77/5

∅ 20 x 6 mm
H 360 mm
L 115 mm

Art. 77/8

∅ 20 x 6 mm
H 450 mm
L 115 mm



Art. 86/6

∅ 12 x 6 mm
H 95 mm
L 40 mm



Art. 646/4

Ø 8 mm
H 180 mm
L 90 mm



ARTEFERRO



forgiato a caldo
hot forged scroll

Art. 645/6

Ø 10 mm
H 400 mm
L 205 mm

Art. 1809/1

Ø 20 x 20 mm
H 410 mm
L 210 mm

Art. 88/G/4

Ø 10 x 10 mm
H 130 mm
L 265 mm

Art. 1298/11

Ø 14 x 14 mm
H 330 mm
L 170 mm



ARTEFERRO



forgiato a caldo
hot forged scroll



Art. 88/N/6

Ø 12 x 6 mm
H 110 mm
L 60 mm

Art. 88/N/7

Ø 10 x 5 mm
H 75 mm
L 50 mm

Art. 30/5

Ø 6 x 6 mm
H 75 mm
L 45 mm

Art. 18/B/3

Ø 12 x 6 mm
H 110 mm
L 70 mm

Art. 88/M/5

Ø 10 x 5 mm
H 125 mm
L 90 mm

Art. 18/B/6

Ø 12 x 6 mm
H 120 mm
L 75 mm

Art. 655/1

Ø 16 x 8 mm
H 120 mm
L 70 mm

Art. 88/N/13

Ø 14 x 6 mm
H 110 mm
L 60 mm

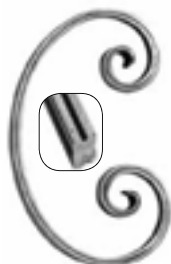

Art. 1303/7

Ø 10 mm
H 195 mm
L 105 mm

Art. 1283/6

Ø 16 x 8 mm
H 240 mm
L 145 mm

Art. 1315/2

Ø 25 x 12 mm
H 205 mm
L 155 mm

Art. 85/4

Ø 10 x 5 mm
H 185 mm
L 135 mm

Art. 85/5

Ø 10 x 5 mm
H 185 mm
L 135 mm

Art. 88/A/4

Ø 12 x 6 mm
H 205 mm
L 130 mm

Art. 1302/3

Ø 12 x 6 mm
H 150 mm
L 105 mm



Art. 1665/1

Ø 14 x 14 mm
H 110 mm - L 85 mm



Art. 1665/2

Ø 14 x 14 mm
H 340 mm - L 100 mm



Art. 1665/3

Ø 14 x 14 mm
H 340 mm - L 100 mm



Art. 88/A/6
 ∅ 16 x 4 mm
 H 220 mm
 L 135 mm



Art. 88/A/5
 ∅ 12 x 6 mm
 H 225 mm
 L 145 mm



Art. 630/4
 ∅ 20 x 10 mm
 H 190 mm
 L 120 mm



Art. 88/N/5
 ∅ 12 x 6 mm
 H 115 mm
 L 60 mm



Art. 84/6
 ∅ 16 x 4 mm
 H 140 mm
 L 70 mm



Art. 84/3
 ∅ 8 x 8 mm
 H 225 mm
 L 90 mm



Art. 88/I/2
 ∅ 14 x 14 mm
 H 145 mm
 L 90 mm



Art. 88/I/3
 ∅ 14 x 14 mm
 H 145 mm
 L 90 mm



Art. 634/7
 ∅ 14 mm
 H 265 mm
 L 195 mm



Art. 87/4
 ∅ 16 x 4 mm
 H 270 mm
 L 125 mm



Art. 634/5
 ∅ 12 mm
 H 215 mm
 L 140 mm

Art. 88/N/12
 ∅ 14 x 6 mm
 H 115 mm
 L 60 mm



Art. 484/2
 ∅ 12 x 12 mm
 H 190 mm
 L 145 mm



Art. 85/7
 ∅ 12 x 12 mm
 H 290 mm
 L 200 mm



Art. 84/4
 ∅ 8 x 8 mm
 H 320 mm
 L 125 mm



Art. 84/2
 ∅ 16 x 4 mm
 H 240 mm
 L 90 mm



Art. 629/7
 ∅ 12 x 6 mm
 H 350 mm
 L 150 mm



Art. 88/M/1
 ∅ 12 x 6 mm
 H 240 mm
 L 125 mm



Art. 84/1
 ∅ 16 x 4 mm
 H 305 mm
 L 120 mm



Art. 634/4
 ∅ 12 x 12 mm
 H 225 mm
 L 160 mm



Art. 1039/2
 ∅ 14 x 14 mm
 H 300 mm
 L 200 mm



Art. 88/L/1
 ∅ 12 x 12 mm
 H 300 mm
 L 220 mm

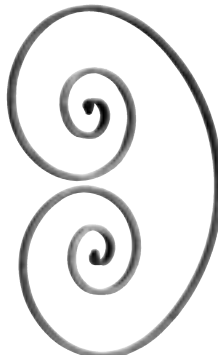

Art. 88/E/3
 ∅ 10 x 10 mm
 H 450 mm
 L 325 mm



Art. 655/3
 ∅ 16 x 8 mm
 H 300 mm
 L 200 mm



Art. 634/6
 ∅ 14 mm
 H 300 mm
 L 220 mm

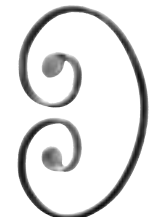

Art. 89/1
 ∅ 12 x 6 mm
 H 245 mm
 L 160 mm



Art. 1667/4
 ∅ 14 x 8 mm
 H 210 mm
 L 140 mm



ARTEFERRO



forgiati a caldo
hot forged
Art. 1809/2
φ 20 x 20 mm
H 270 mm
L 210 mm

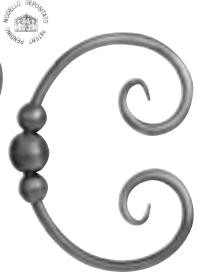

sfere vuote
hollow spheres
Art. 1212/3
Ø 12 mm
H 230 mm
L 180 mm



sfere vuote
hollow spheres
Art. 1212/4
Ø 12 mm
H 135 mm
L 90 mm

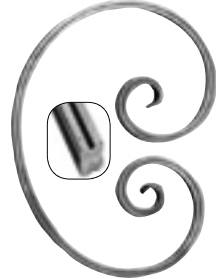

Art. 1283/5
φ 16 x 8 mm
H 260 mm
L 190 mm



Art. 1283/7
φ 16 x 8 mm
H 210 mm
L 150 mm



Art. 645/3
φ 8 x 8 mm
H 205 mm
L 140 mm



Art. 1291/3
Ø 10 mm
H 210 mm
L 150 mm



Art. 1655/2
φ 12 x 6 mm
H 210 mm
L 140 mm



Art. 684/7
φ 16 x 8 mm
H 180 mm
L 120 mm



Art. 1290/3
Ø 10 mm
H 180 mm
L 100 mm



Art. 655/2
φ 16 x 8 mm
H 160 mm
L 100 mm



Art. 88/7
φ 12 x 6 mm
H 370 mm
L 145 mm



Art. 88/8
φ 12 x 6 mm
H 180 mm
L 120 mm



Art. 1297/15
φ 10 x 10 mm
H 360 mm
L 130 mm



Art. 1298/13
φ 14 x 14 mm
H 300 mm
L 200 mm



Art. 84/5
φ 16 x 4 mm
H 300 mm
L 120 mm

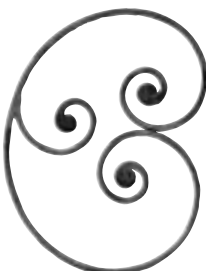

Art. 1291/2
Ø 10 mm
H 400 mm
L 300 mm



Art. 6115/1
φ 16 x 8 mm
H 350 mm
L 210 mm



Art. 1283/4
φ 16 x 8 mm
H 440 mm
L 300 mm

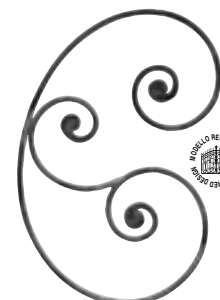

Art. 1291/1
Ø 10 mm
H 475 mm
L 315 mm



Art. 90/2
φ 10 x 5 mm
H 155 mm
L 180 mm



Art. 1122/6
φ 12 x 6 mm
H 180 mm
L 140 mm



Art. 1299/2
φ 12 x 6 mm
H 140 mm
L 140 mm



Art. 91/6
φ 12 x 6 mm
H 220 mm
L 160 mm



Art. 92/1
φ 12 x 6 mm
H 220 mm
L 160 mm

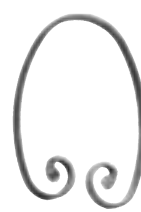

Art. 91/1
φ 12 x 6 mm
H 220 mm
L 165 mm



Art. 1655/3
φ 12 x 6 mm
H 210 mm
L 170 mm



Art. 1639/2
φ 20 x 6 mm
H 240 mm
L 200 mm



Art. 1639/3
φ 20 x 6 mm
H 240 mm
L 200 mm

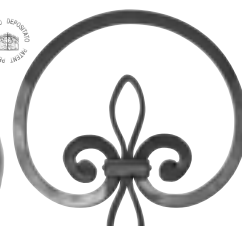

Art. 452/3
φ 14 x 14 mm
H 280 mm
L 265 mm



Art. 452/2
φ 14 x 14 mm
H 220 mm
L 265 mm



Art. 1796/4
φ 14 x 14 mm
H 220 mm
L 250 mm

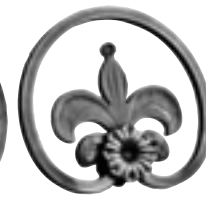

Art. 1796/5
φ 14 x 14 mm
H 220 mm
L 250 mm



Art. 646/5
 Ø 8 mm
 H 220 mm
 L 120 mm



Art. 6108/1
 14 x 8 mm
 H 290 mm
 L 130 mm



Art. 88/G/6
 10 x 10 mm
 H 230 mm
 L 120 mm



Art. 642/4
 Ø 10 mm
 H 180 mm
 L 400 mm



Art. 88/I/1
 14 x 14 mm
 H 245 mm
 L 100 mm



Art. 1297/16
 10 x 10 mm
 H 200 mm
 L 80 mm



Art. 88/N/3
 12 x 6 mm
 H 270 mm
 L 110 mm

Art. 88/N/10
 14 x 6 mm
 H 270 mm
 L 110 mm
battuto a caldo
hot hammered



Art. 1290/2
 Ø 10 mm
 H 230 mm
 L 110 mm



Art. 1301/13
 12 x 6 mm
 H 280 mm
 L 95 mm



Art. 1301/12
 12 x 6 mm
 H 240 mm
 L 80 mm



Art. 628/1
 5 x 5 mm
 H 250 mm
 L 85 mm



Art. 628/2
 5 x 5 mm
 H 220 mm
 L 85 mm



Art. 628/3
 5 x 5 mm
 H 175 mm
 L 60 mm



Art. 628/4
 5 x 5 mm
 H 140 mm
 L 60 mm



Art. 646/8
 Ø 8 mm
 H 290 mm
 L 120 mm



Art. 635/4
 12 x 12 mm
 H 290 mm
 L 95 mm



Art. 1290/1
 Ø 10 mm
 H 300 mm
 L 110 mm



Art. 88/L/3
 12 x 12 mm
 H 385 mm
 L 190 mm



Art. 648/3
 Ø 10 mm
 H 400 mm
 L 180 mm



Art. 646/6
 Ø 8 mm
 H 360 mm
 L 120 mm



Art. 630/1
 20 x 10 mm
 H 335 mm
 L 115 mm



Art. 88/B/2
 12 x 12 mm
 H 510 mm
 L 150 mm



Art. 635/2
 12 x 12 mm
 H 390 mm
 L 155 mm



Art. 153/2
 Ø 12 mm
 H 430 mm
 L 150 mm

borchia in tubo
 steel tube bush



Art. 645/7
 Ø 10 mm
 H 440 mm
 L 190 mm



Art. 88/B/1
 Φ 8 x 8 mm
 H 305 mm
 L 75 mm



Art. 646/7
 Ø 8 mm
 H 360 mm
 L 120 mm



Art. 1298/10
 ⌀ 14 x 14 mm
 H 320 mm
 L 150 mm

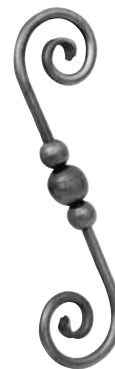

Art. 1212/2
 Ø 12 mm
 H 360 mm
 L 95 mm
 sfere vuote
 hollow spheres



Art. 646/3
 Ø 8 mm
 H 245 mm
 L 80 mm



Art. 635/3
 Φ 12 x 12 mm
 H 370 mm
 L 110 mm



Art. 88/N/2
 ⌀ 12 x 6 mm
 H 290 mm
 L 120 mm

Art. 88/N/9
 ⌀ 14 x 6 mm
 H 290 mm
 L 120 mm



Art. 88/N/1
 ⌀ 12 x 6 mm
 H 360 mm
 L 120 mm

Art. 88/N/8
 ⌀ 14 x 6 mm
 H 360 mm
 L 120 mm



Art. 75/33
 Φ 8 x 8 mm
 H 350 mm
 L 120 mm

Art. 75/31
 ⌀ 10 x 5 mm
 H 350 mm
 L 120 mm

Art. 75/32
 ⌀ 12 x 6 mm
 H 350 mm
 L 120 mm



Art. 629/4
 ⌀ 20 x 10 mm
 H 530 mm
 L 125 mm



Art. 635/1
 Φ 12 x 12 mm
 H 450 mm
 L 125 mm



Art. 1298/7
 ⌀ 14 x 14 mm
 H 500 mm
 L 150 mm



Art. 88/D/2
 ∅ 20 x 4 mm
 H 190 mm
 L 150 mm



Art. 84/8
 ∅ 20 x 6 mm
 H 190 mm
 L 95 mm



Art. 630/5
 ∅ 20 x 10 mm
 H 120 mm
 L 100 mm



Art. 630/6
 ∅ 20 x 10 mm
 H 130 mm
 L 80 mm



Art. 1039/3
 ∅ 14 x 14 mm
 H 120 mm
 L 90 mm



Art. 86/3
 ∅ 12 x 6 mm
 H 90 mm
 L 50 mm



Art. 85/3
 ∅ 16 x 4 mm
 H 140 mm
 L 120 mm



Art. 688/4
 ∅ 12 mm
 H 125 mm
 L 90 mm



Art. 688/9
 ∅ 12 mm
 H 140 mm
 L 100 mm



Art. 686/18
 ∅ 12 mm
 H 120 mm
 L 100 mm



Art. 686/17
 ∅ 12 mm
 H 120 mm
 L 100 mm



Art. 628/5
 ∅ 5 x 5 mm
 H 145 mm
 L 50 mm



Art. 18/B/2
 ∅ 12 x 6 mm
 H 180 mm
 L 60 mm



Art. 18/B/5
 ∅ 12 x 6 mm
 H 240 mm
 L 60 mm

Art. 688/5
 ∅ 12 mm
 H 125 mm
 L 90 mm

Art. 688/6
 ∅ 12 mm
 H 150 mm
 L 110 mm

Art. 688/7
 ∅ 12 mm
 H 150 mm
 L 110 mm



Art. 88/G/2
 ∅ 10 x 10 mm
 H 165 mm
 L 75 mm



Art. 88/D/1
 ∅ 20 x 4 mm
 H 250 mm
 L 95 mm



Art. 629/3
 ∅ 20 x 10 mm
 H 290 mm
 L 90 mm



Art. 629/1
 ∅ 20 x 10 mm
 H 240 mm
 L 85 mm



Art. 1809/3
 ∅ 20 x 20 mm
 H 250 mm
 L 140 mm



Art. 1809/4
 ∅ 20 x 20 mm
 H 280 mm
 L 210 mm

forgiato
hot forged

forgiato
hot forged



Art. 6092/4
 ∅ 20 x 20 mm
 H 500 mm
 L 220 mm

Art. 6112/4
 ∅ 20 x 20 mm
 H 250 mm
 L 150 mm



Art. 88/G/1
 ∅ 10 x 10 mm
 H 250 mm
 L 120 mm



Art. 630/12
 ∅ 40 x 10 mm
 H 330 mm
 L 125 mm



Art. 630/11
 ∅ 40 x 10 mm
 H 360 mm
 L 200 mm



Art. 630/10
 ∅ 40 x 10 mm
 H 470 mm
 L 200 mm



ARTEFERRO



Art. 3002/7
 Ø 14 x 14 mm
 H 170 mm
 L 105 mm



Art. 6131/1
 Ø 16 x 16 mm
 H 200 mm
 L 120 mm



Art. 1275/4
 Ø 40 x 4 mm
 H 180 mm
 L 130 mm



Art. 684/5
 Ø 16 x 8 mm
 H 140 mm
 L 110 mm



Art. 6096/1
 Ø 14 x 14 mm
 H 100 mm
 L 100 mm



Art. 1302/4
 Ø 12 x 6 mm
 H 105 mm
 L 60 mm



Art. 1302/5
 Ø 12 x 6 mm
 H 105 mm
 L 60 mm



Art. 1291/5
 Ø 10 mm
 H 270 mm
 L 130 mm



Art. 1796/3
 Ø 14 x 14 mm
 H 220 mm
 L 125 mm



Art. 630/9
 Ø 20 x 10 mm
 H 310 mm
 L 125 mm



Art. 636/3
 Ø 12 x 12 mm
 H 320 mm
 L 90 mm



Art. 88/D/3
 Ø 16 x 4 mm
 H 360 mm
 L 140 mm



Art. 630/7
 Ø 20 x 10 mm
 H 380 mm
 L 210 mm



Art. 630/2
 Ø 40 x 10 mm
 H 320 mm
 L 80 mm



ARTEFERRO



Art. 483/3
 Ø 14 x 14 mm
 H 400 mm
 L 200 mm

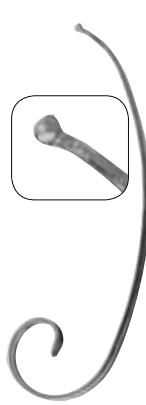

Art. 629/6
 Ø 12 x 6 mm
 H 400 mm
 L 125 mm



liscio/plain

Art. 1038/3
 Ø 14 x 14 mm
 H 400 mm
 L 200 mm



Art. 636/2
 Ø 12 x 12 mm
 H 430 mm
 L 150 mm

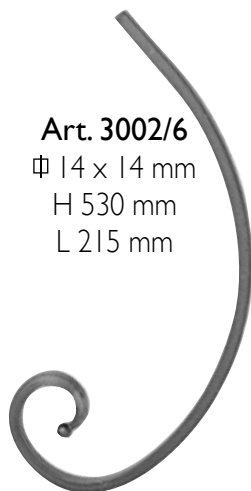

Art. 3002/6
 Ø 14 x 14 mm
 H 530 mm
 L 215 mm

Art. 688/2
 Ø 12 mm
 H 400 mm
 L 300 mm

Art. 688/3
 Ø 12 mm
 H 550 mm
 L 350 mm

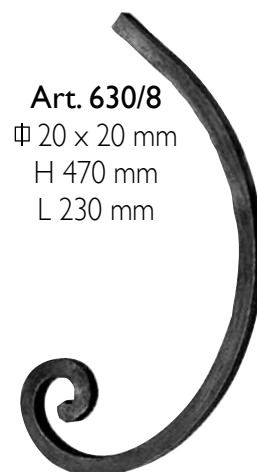

Art. 630/8
 Ø 20 x 20 mm
 H 470 mm
 L 230 mm



Art. 86/2

∅ 12 x 6 mm
H 350 mm
L 85 mm



Art. 86/1

∅ 12 x 6 mm
H 385 mm
L 110 mm



Art. 70/B/6

∅ 12 x 12 mm
H 430 mm
L 92 mm



Art. 88/E/2

∅ 12 x 6 mm
H 420 mm
L 115 mm



Art. 92/C/3

∅ 12 x 16 mm
H 380 mm
L 95 mm



Art. 88/B/4

∅ 12 x 16 mm
H 460 mm
L 87 mm



Art. 64/E/5

∅ 12 x 6 mm
H 245 mm
L 48 mm



Art. 87/2

∅ 12 x 6 mm
H 227 mm
L 175 mm



Art. 88/E/1

∅ 12 x 6 mm
H 205 mm
L 60 mm



Art. 64/E/6

∅ 12 x 6 mm
H 240 mm
L 60 mm



Art. 1302/1

∅ 12 x 6 mm
H 230 mm
L 50 mm



Art. 1302/2

∅ 12 x 6 mm
H 250 mm
L 75 mm



Art. 88/E/5

∅ 12 x 6 mm
H 250 mm
L 75 mm



Art. 1301/15

∅ 12 x 3 mm
H 280 mm
L 45 mm



Art. 1301/16

∅ 12 x 3 mm
H 255 mm
L 60 mm



Art. 1301/17

∅ 12 x 3 mm
H 180 mm
L 110 mm



Art. 88/1

∅ 12 x 6 mm
H 320 mm
L 80 mm



Art. 77/1

∅ 16 x 4 mm
H 450 mm
L 100 mm



Art. 75/34

∅ 10 x 10 mm
H 330 mm
L 130 mm



Art. 86/4

∅ 12 x 6 mm
H 220 mm
L 75 mm



Art. 6214/1

∅ 14 x 8 mm
H 320 mm
L 130 mm



Art. 64/E/4

∅ 12 x 6 mm
H 240 mm
L 65 mm



Art. 1301/14

∅ 12 x 3 mm
H 250 mm
L 55 mm



Art. 88/C/1

∅ 12 x 6 mm
H 190 mm
L 60 mm



Art. 628/6

∅ 5 x 5 mm
H 105 mm
L 40 mm



ARTEFERRO



Art. 1301/11
 ∅ 14 x 8 mm
 H 360 mm
 L 100 mm



Art. 645/1
 ∅ 8 x 8 mm
 H 430 mm
 L 70 mm



Art. 645/4
 ∅ 12 x 12 mm
 H 415 mm
 L 90 mm



Art. 88/G/5
 ∅ 10 x 10 mm
 H 250 mm
 L 120 mm



Art. 471/3
 ∅ 14 x 8 mm
 H 425 mm
 L 125 mm



Art. 83/1
 ∅ 8 x 8 mm
 H 235 mm
 L 105 mm



Art. 92/D/3
 ∅ 12 x 6 mm
 H 550 mm
 L 112 mm



Art. 92/D/4
 ∅ 12 x 6 mm
 H 550 mm
 L 112 mm



Art. 88/B/3
 ∅ 12 x 6 mm
 H 350 mm
 L 70 mm



Art. 1667/5
 ∅ 14 x 8 mm
 H 310 mm
 L 60 mm



Art. 1328/5
 ∅ 8 mm
 L 400 mm



Art. 629/2
 ∅ 20 x 10 mm
 H 320 mm
 L 115 mm



Art. 629/3
 ∅ 20 x 10 mm
 H 290 mm
 L 90 mm



Art. 629/5
 ∅ 20 x 10 mm
 H 440 mm
 L 135 mm



Art. 1275/2
 ∅ 40 x 4 mm
 H 415 mm
 L 145 mm



Art. 80/B/1
 ∅ 16 x 4 mm
 H 375 mm
 L 50 mm

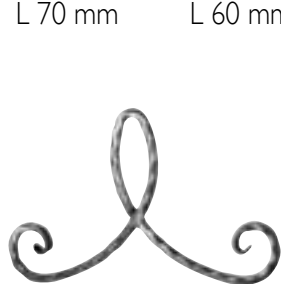

Art. 1304/1
 ∅ 12 x 12 mm
 H 265 mm
 L 420 mm



Art. 636/5
 ∅ 16 x 16 mm
 H 315 mm
 L 155 mm



Art. 594/5
 ∅ 12 x 12 mm
 H 310 mm
 L 150 mm



Art. 88/M/4
 ∅ 12 x 6 mm
 H 235 mm
 L 155 mm



Art. 887/1
 ∅ 14 x 14 mm
 H 380 mm
 L 290 mm



Art. 1299/1
 ∅ 12 x 6 mm
 H 140 mm
 L 60 mm



Art. 80/B/6
 ∅ 12 x 6 mm
 H 375 mm
 L 50 mm



Art. 888/1
 ∅ 12 x 12 mm
 H 300 mm
 L 220 mm

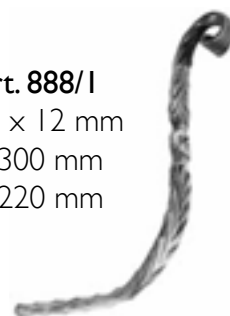

Art. 76/4
 ∅ 16 x 4 mm
 H 290 mm
 L 120 mm

Art. 76/5
 ∅ 20 x 4 mm
 H 290 mm
 L 120 mm



ARTEFERRO



Art. 1308/1
 Φ 12 x 12 mm
 H 360 mm
 L 180 mm

Art. 1308/2
 Φ 14 x 14 mm
 H 360 mm
 L 180 mm

Art. 1308/11
 Φ 14 mm
 H 360 mm
 L 180 mm

Art. 1308/7
 Φ 16 mm
 H 360 mm
 L 180 mm



Art. 1308/5
 E 12 x 12 mm
 H 360 mm
 L 180 mm

Art. 1308/6
 E 14 x 14 mm
 H 360 mm
 L 180 mm



Art. 1291/4
 Φ 10 mm
 H 280 mm
 L 210 mm



Art. 1308/3
 Φ 12 x 12 mm
 H 360 mm
 L 180 mm

Art. 1308/4
 Φ 14 x 14 mm
 H 360 mm
 L 180 mm



Art. 1308/12
 Φ 12 x 12 mm
 H 350 mm
 L 150 mm

Art. 1308/13
 Φ 14 x 14 mm
 H 350 mm
 L 150 mm



Art. 1308/8
 Φ 14 mm
 H 350 mm
 L 150 mm

Art. 1308/9
 Φ 16 mm
 H 350 mm
 L 150 mm



ARTEFERRO

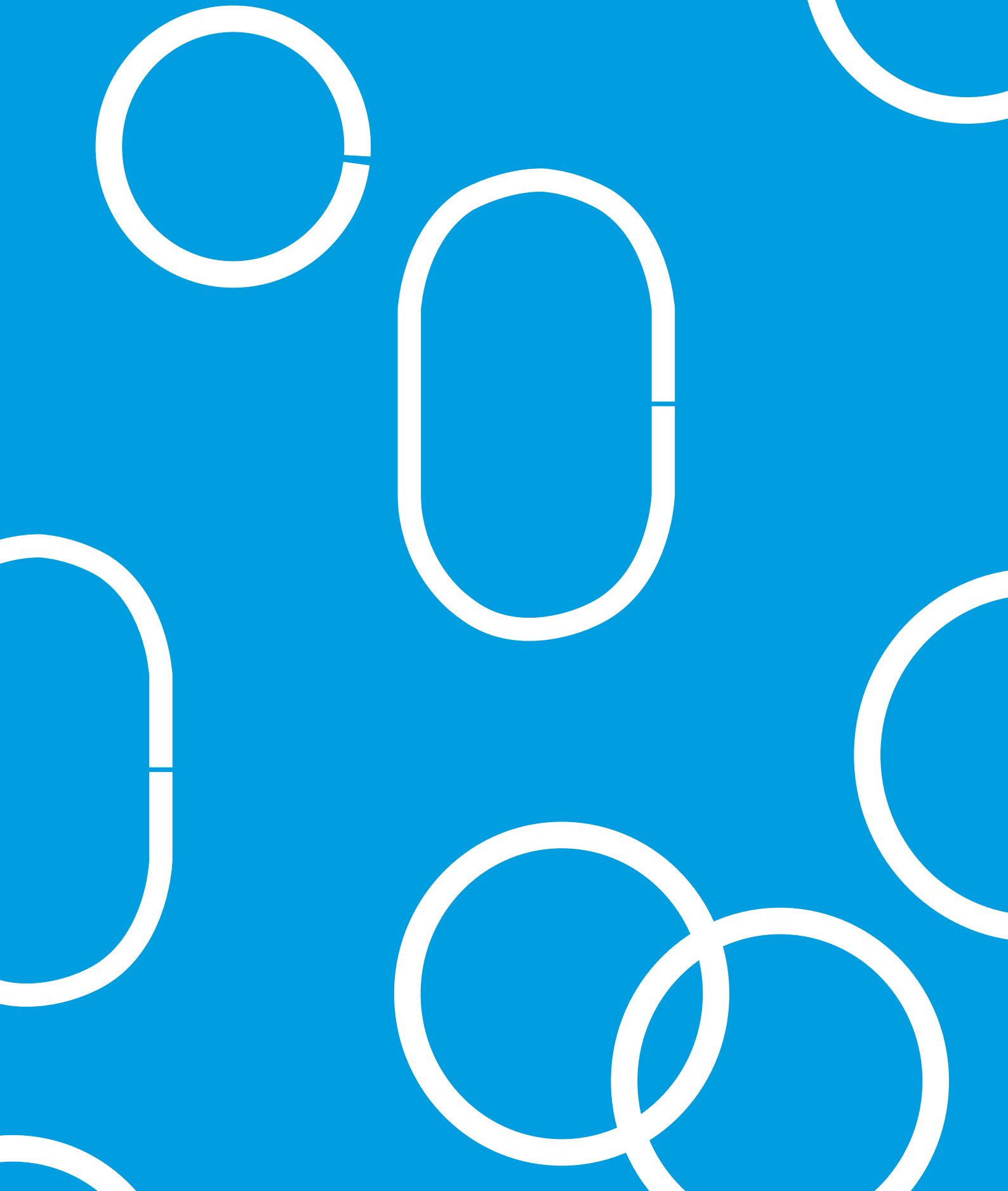

CERCHI - RINGS

COMPENDIUM 2011

Art. 491/8
Art. 1317/13
Art. 1320/1



Cerchi Lisci

Plain Rings



∅ = diameter

Sezione Iron cross mm	∅ 10 mm	∅ 12 mm	∅ 14 mm	∅ 16 mm	中 12 x 12 mm	中 14 x 14 mm	中 16 x 16 mm	中 18 x 18 mm	中 20 x 20 mm	中 25 x 25 mm	中 30 x 30 mm
	Cod.art./Art.no.	Cod.art./Art.no.	Cod.art./Art.no.	Cod.art./Art.no.	Cod.art./Art.no.	Cod.art./Art.no.	Cod.art./Art.no.	Cod.art./Art.no.	Cod.art./Art.no.	Cod.art./Art.no.	Cod.art./Art.no.
∅ 89					491/8/D89						
∅ 100	1317/6	1317/9	1803/4		491/8	491/16	491/17				
∅ 105					1802/64	1802/65	1802/114				
∅ 110			1803/7		1802/68	1802/69	1802/70				
∅ 115	1317/7	1317/10	1803/5		1317/1	1802/73	1802/74				
∅ 120					1802/77	1802/78	1802/79				
∅ 127					491/8/D127						
∅ 130	1317/8	1317/11	1803/6		1317/2	1802/82	1802/83	1802/84	1802/85		
∅ 133					491/8/D133						
∅ 135				1803/8			1802/115				
∅ 140					491/8/D140						
∅ 160					1802/88	1802/89	1802/90	1802/91	1802/92	1802/93	
∅ 180					1802/96	1802/97	1802/98	1802/99	1802/100	1802/101	1802/102
∅ 190											
∅ 200					1802/105	1802/106	1802/107	1802/108	1802/109	1802/110	1802/111

Qualsiasi misura su richiesta Special dimensions available upon request

Sezione Iron cross mm	∕ 12 x 6 mm	∕ 14 x 6 mm	∕ 14 x 8 mm	∕ 16 x 4 mm	∕ 16 x 6 mm	∕ 16 x 8 mm	∕ 20 x 4 mm	∕ 20 x 6 mm	∕ 20 x 8 mm	∕ 25 x 4 mm	∕ 30 x 8 mm	∕ 40 x 8 mm
	Cod.art./Art.no.	Cod.art./Art.no.	Cod.art./Art.no.	Cod.art./Art.no.	Cod.art./Art.no.	Cod.art./Art.no.	Cod.art./Art.no.	Cod.art./Art.no.	Cod.art./Art.no.	Cod.art./Art.no.	Cod.art./Art.no.	Cod.art./Art.no.
∅ 100	157/1	1320/7	1320/10	1320/1	1802/1	1802/2	157/6	1320/4	1802/3	157/11	1802/112	1802/113
∅ 105	1802/4	1802/5	1802/6	1802/7	1802/8	1802/9	1802/10	1802/11	1802/12		1802/62	1802/63
∅ 110	1802/13	1802/14	1802/15	1802/16	1802/17	1802/18	1802/19	1802/20	1802/21		1802/66	1802/67
∅ 115	157/2	1320/8	1320/11	1320/2	1802/22	1802/23	157/7	1320/5	1802/24	157/12	1802/71	1802/72
∅ 120	1802/25	1802/26	1802/27	1802/28	1802/29	1802/30	1802/31	1802/32	1802/33		1802/75	1802/76
∅ 130	157/3	1320/9	1320/12	1320/3	1802/34	1802/35	157/8	1320/6	1802/36	157/13	1802/80	1802/81
∅ 160	157/4	1802/37	1802/38	1802/39	1802/40	1802/41	157/9	1802/42	1802/43	157/14	1802/86	1802/87
∅ 180	1802/44	1802/45	1802/46	1802/47	1802/48	1802/49	1802/50	1802/51	1802/52		1802/94	1802/95
∅ 190	157/5						157/10			157/15		
∅ 200	1802/53	1802/54	1802/55	1802/56	1802/57	1802/58	1802/59	1802/60	1802/61		1802/103	1802/104

Ø = diameter



SEZIONE
IRON CROSS
12 x 12 mm

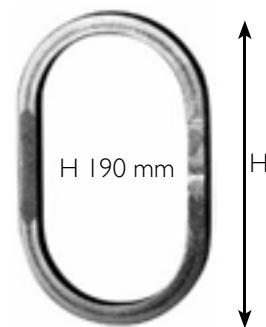

LISCIO
PLAIN



CORTECCIA
BARK EFFECT



DIAMANTATO
DIAMOND HAMMER
PROFILE



SPIGOLATO
HAMMERED
on EDGES



QUADRIFOGLIO
FOUR LEAF CLOVER



	Cod.art./Art.no.	Cod.art./Art.no.
L 100 mm	491/8	1317/3
L 115 mm	1317/1	1317/4
L 130 mm	1317/2	1317/5
L 100 mm	1317/18	1317/21
L 115 mm	1317/19	1317/22
L 130 mm	1317/20	1317/23
L 100 mm	1318/1	1318/4
L 115 mm	1318/2	1318/5
L 130 mm	1318/3	1318/6
L 100 mm	491/9	1318/9
L 115 mm	1318/7	1318/10
L 130 mm	1318/8	1318/11
L 100 mm	1318/12	1318/15
L 115 mm	1318/13	1318/16
L 130 mm	1318/14	1318/17
L 100 mm	1319/1	1319/4
L 115 mm	1319/2	1319/5
L 130 mm	1319/3	1319/6

Cerchi Ovali - Ovals Rings

H 190 mm

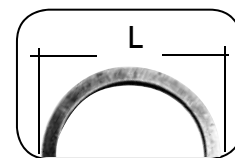

H x L mm	Ø 10 mm	Ø 12 mm	12 x 12 mm	12 x 6 mm	14 x 6 mm	14 x 8 mm	16 x 4 mm	20 x 4 mm	20 x 6 mm
	Cod.art./Art.no.	Cod.art./Art.no.	Cod.art./Art.no.	Cod.art./Art.no.	Cod.art./Art.no.	Cod.art./Art.no.	Cod.art./Art.no.	Cod.art./Art.no.	Cod.art./Art.no.
190 x 100	1317/12	1317/15	1317/3	1320/22	1320/19	1320/28	1320/13	1320/25	1320/16
190 x 115	1317/13	1317/16	1317/4	1320/23	1320/20	1320/29	1320/14	1320/26	1320/17
190 x 130	1317/14	1317/17	1317/5	1320/24	1320/21	1320/30	1320/15	1320/27	1320/18

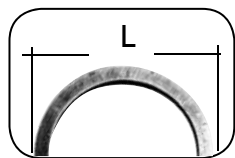

TACCHETTATO
HAMMERED



DIAMANTATO
DIAMOND HAMMER
PROFILE

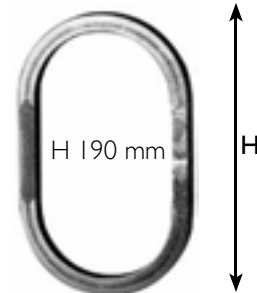

	∅ 12 x 6 mm	∅ 14 x 6 mm	∅ 14 x 8 mm	∅ 12 x 6 mm	∅ 14 x 8 mm
	Cod.art./Art.no.	Cod.art./Art.no.	Cod.art./Art.no.	Cod.art./Art.no.	Cod.art./Art.no.
L 100 mm	491/3	1319/7	-	1319/10	1319/13
L 115 mm	491/4	1319/8	-	1319/11	1319/14
L 130 mm	491/5	1319/9	-	1319/12	1319/15
L 100 mm	491/6	491/13	1319/18	1319/21	1319/24
L 115 mm	1319/16	491/14	1319/19	1319/22	1319/25
L 130 mm	1319/17	491/15	1319/20	1319/23	1319/26

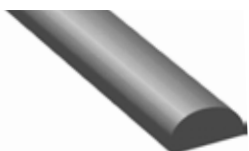

	∅ 20 x 10 mm	∅ 30 x 15 mm	∅ 20 x 10 mm	∅ 30 x 15 mm
	Cod.art./Art.no.	Cod.art./Art.no.	Cod.art./Art.no.	Cod.art./Art.no.
L 100 mm	1319/27	1319/30	-	-
L 115 mm	1319/28	1319/31	-	-
L 130 mm	1319/29	1319/32	-	-
L 100 mm	-	-	1319/33	1319/36
L 115 mm	-	-	1319/34	1319/37
L 130 mm	-	-	1319/35	1319/38

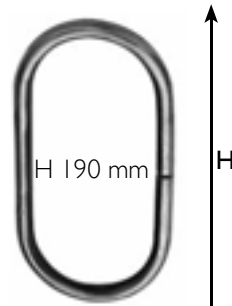
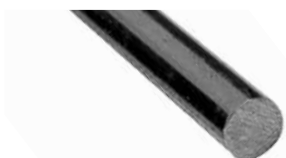

	∅ 10 mm	∅ 12 mm	∅ 10 mm	∅ 12 mm
	Cod.art./Art.no.	Cod.art./Art.no.	Cod.art./Art.no.	Cod.art./Art.no.
L 100 mm	1317/6	1317/9	1317/12	1317/15
L 115 mm	1317/7	1317/10	1317/13	1317/16
L 130 mm	1317/8	1317/11	1317/14	1317/17

Quadrati - Squares

Disponibili solo per quantità
Available only in quantities

Lato Side mm	⊕ 8 × 8 mm	⊕ 10 × 10 mm	⊕ 12 × 12 mm	⊕ 14 × 14 mm	▧ 12 × 6 mm	▧ 16 × 4 mm	▧ 20 × 4 mm	▧ 20 × 6 mm	▧ 25 × 4 mm	▧ 30 × 8 mm	▧ 40 × 4 mm
	Cod.art./Art.no.	Cod.art./Art.no.	Cod.art./Art.no.	Cod.art./Art.no.	Cod.art./Art.no.	Cod.art./Art.no.	Cod.art./Art.no.	Cod.art./Art.no.	Cod.art./Art.no.	Cod.art./Art.no.	Cod.art./Art.no.
140 × 140	31/5	31/6	–	–	31/7	31/8	31/9	31/10	31/11	31/12	31/13
150 × 150	31/14	31/15	31/16	31/17	31/18	31/19	31/20	31/21	31/22	31/23	31/24
160 × 160	31/25	31/26	31/27	31/28	31/29	31/30	31/31	31/32	31/33	31/34	31/35
180 × 180	31/36	31/37	31/38	31/39	31/40	31/41	31/42	31/43	31/44	31/45	31/46
200 × 200	31/47	31/48	31/49	31/50	31/51	31/52	31/53	31/54	31/55	31/56	31/57



Rettangoli - Rectangles

Disponibili solo per quantità
Available only in quantity

Lato Side mm	⊕ 8 × 8 mm	⊕ 10 × 10 mm	⊕ 12 × 12 mm	⊕ 14 × 14 mm	▧ 12 × 6 mm	▧ 16 × 4 mm	▧ 20 × 4 mm	▧ 20 × 6 mm	▧ 25 × 4 mm	▧ 30 × 8 mm	▧ 40 × 4 mm
	Cod.art./Art.no.	Cod.art./Art.no.	Cod.art./Art.no.	Cod.art./Art.no.	Cod.art./Art.no.	Cod.art./Art.no.	Cod.art./Art.no.	Cod.art./Art.no.	Cod.art./Art.no.	Cod.art./Art.no.	Cod.art./Art.no.
140 × 280	31/58	31/59	–	–	31/60	31/61	31/62	31/63	31/64	31/65	31/66
150 × 300	31/67	31/68	31/69	31/70	31/71	31/72	31/73	31/74	31/75	31/76	31/77
160 × 320	31/78	31/79	31/80	31/81	31/83	31/83	31/84	31/85	31/86	31/87	31/88
180 × 360	31/89	31/90	31/91	31/92	31/94	31/94	31/95	31/96	31/97	31/98	31/99
200 × 400	31/100	31/101	31/102	31/103	31/105	31/105	31/106	31/107	31/108	31/109	31/110



Art. 156/1
 Φ 12 × 12 mm
 H 160 mm
 L 117 mm



Art. 156/6
 Φ 14 × 14 mm
 H 273 mm
 L 192 mm



Art. 156/2
 Φ 12 × 12 mm
 H 175 mm
 L 125 mm



Art. 156/3
 Φ 12 × 12 mm
 H 170 mm
 L 130 mm

Art. 156/4
 Φ 14 × 14 mm
 H 240 mm
 L 170 mm

Art. 156/5
 Φ 14 × 14 mm
 H 249 mm
 L 176 mm

Art. 157/16
 □ 12 × 6 mm
 H 160 mm
 L 115 mm



Art. GD77/1
 Φ 12 × 12 mm
 H 65 mm
 L 100 mm



Art. 156/A/6
 Φ 5 × 5 mm
 Ø 63 mm



Art. 491/7
 □ 17 × 12 mm
 Ø 85 mm

Art. 1320/34
 □ 14 × 6 mm
 H 160 mm
 L 115 mm

Art. 1320/35
 □ 20 × 6 mm
 H 160 mm
 L 115 mm



Art. 88/11
 Φ 8 × 8 mm
 H 110 mm
 L 100 mm

Art. 88/12
 Φ 8 × 8 mm
 H 100 mm
 L 90 mm

Art. 157/17
 □ 12 × 6 mm
 H 100 mm
 L 90 mm

Art. 157/18
 □ 12 × 6 mm
 H 115 mm
 L 105 mm



Art. 684/6
 □ 16 × 8 mm
 Ø 75 mm

Art. 691/5
 Ø 12 mm
 Ø 75 mm

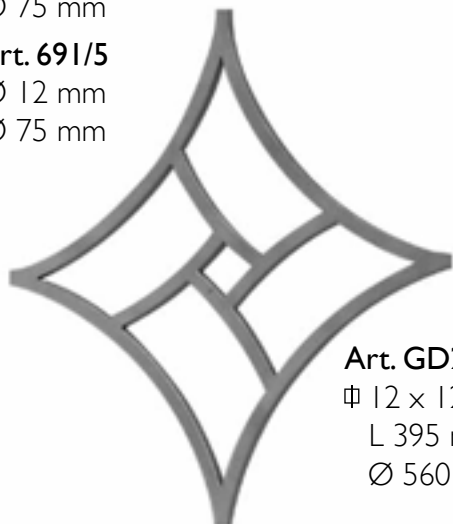

Art. GD211/2
 Φ 12 × 12 mm
 L 395 mm
 Ø 560 mm



ARTEFERRO



Φ 6 x 6 mm
Art. 156/A/1
 Φ 25 mm
Art. 156/A/2
 Φ 30 mm
Art. 156/A/3
 Φ 40 mm
Art. 156/A/4
 Φ 40 mm
Art. 156/A/5
 Φ 63 mm

Art. 491/10
 Φ 100 mm
Art. 491/11
 Φ 115 mm
Art. 491/12
 Φ 130 mm



∇ 14 x 8 mm
Art. 1319/18
 Φ 100 mm
Art. 1319/19
 Φ 115 mm
Art. 1319/20
 Φ 130 mm

∇ 12 x 6 mm
Art. 1803/1
 Φ 100 mm
Art. 1803/2
 Φ 115 mm
Art. 1803/3
 Φ 130 mm



∇ 12 x 6 mm
Art. 1299/5
 Φ 100 mm
Art. 1299/6
 Φ 130 mm

∇ 14 x 6 mm
Art. 1299/7
 Φ 100 mm
Art. 1299/8
 Φ 130 mm

Φ 16 x 16 mm

Art. 638/1
 Φ 155 mm
Art. 638/3
 Φ 250 mm
Art. 638/6
 Φ 350 mm



Φ 12 x 12 mm

Art. 638/2
 Φ 210 mm
Art. 638/5
 Φ 510 mm



∇ 12 x 6 mm
Art. 1320/31
 H 100 mm
 L 170 mm
Art. 1320/32
 H 115 mm
 L 190 mm
Art. 1320/33
 H 220 mm
 L 230 mm





Art. 638/4
Φ 16 x 16 mm
H 690 mm
L 560 mm

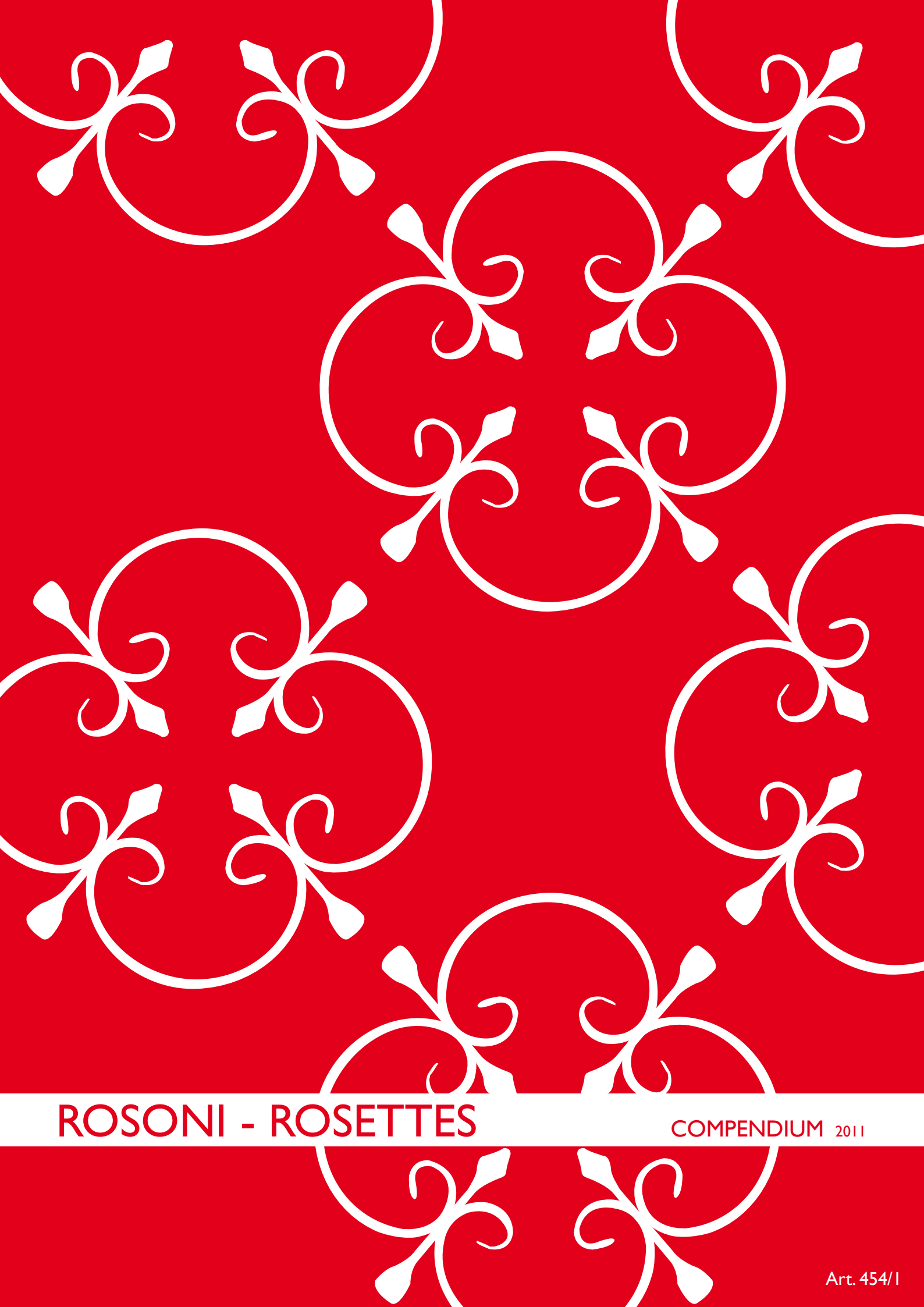

ROSONI - ROSETTES

COMPENDIUM 2011

Art. 454/I



spigolato
hammered on edges
Art. 26/C/1
Φ 12 x 12 mm
H 530 mm
L 430 mm

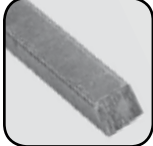

liscio/plain
Art. 1641/2
Φ 12 x 12 mm
H 530 mm
L 430 mm

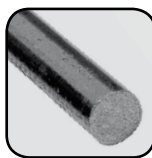

liscio/plain
Art. 1641/1
Ø 14 mm
H 610 mm
L 475 mm



ARTEFERRO

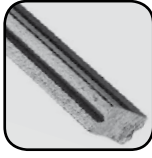

rigato/grooved
Art. NEW0004
▧ 16 x 8 mm
H 665 mm
L 520 mm

ROSONI ESTENSIBILI
EXTENDIBLE ROSETTES

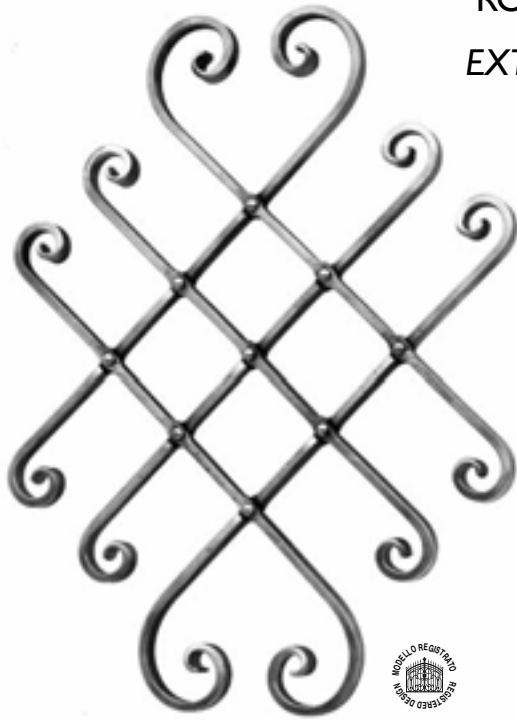

Art. 1658/1

∅ 16 x 8 mm

H 580 mm ↔ H₁ 620 mm
L 440 mm L₁ 380 mm

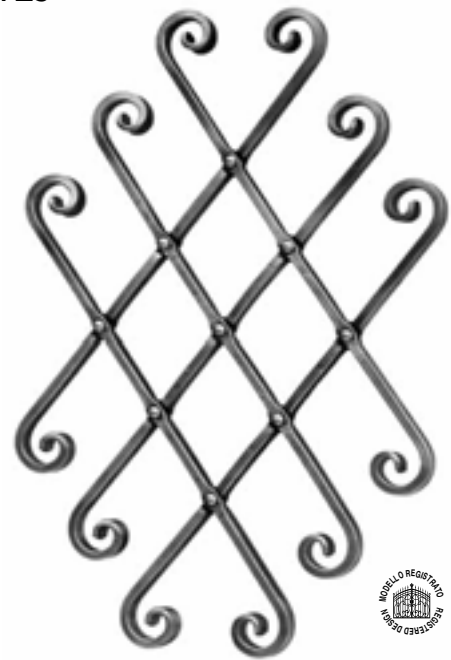
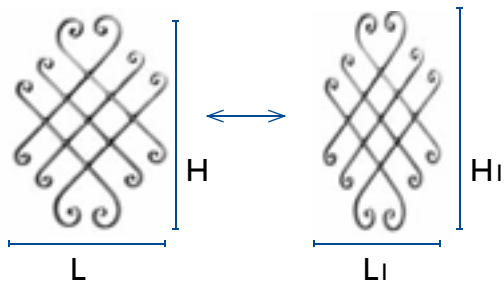

Art. 1658/2

∅ 16 x 8 mm

H 490 mm ↔ H₁ 550 mm
L 440 mm L₁ 360 mm

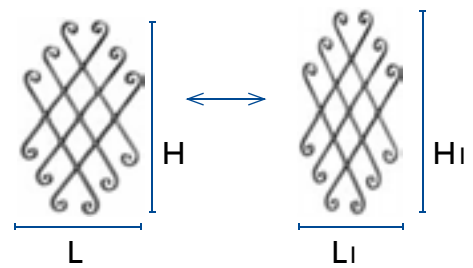

ROSONI - ROSETTES

Ø 250 mm - Φ 8 x 8 mm



con fascette
with collars
Art. 19/1

senza fascette
without collars
Art. 19/2

Ø 250 mm - Φ 8 x 8 mm



con fascette
with collars
Art. 17/1

senza fascette
without collars
Art. 17/2

Ø 250 mm - \square 10 x 5 mm



con fascette
with collars
Art. 23/1

senza fascette
without collars
Art. 22/B/2

Ø 250 mm - Φ 8 x 8 mm

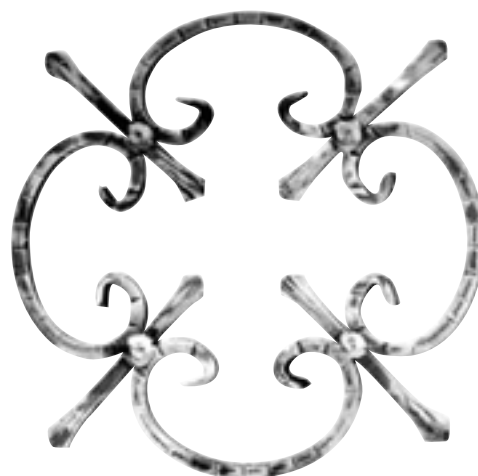

con fascette
with collars
Art. 18/1

senza fascette
without collars
Art. 18/2



ARTEFERRO



Art. 18/A/1
 Φ 8 x 8 mm
Ø 250 mm



Art. 33/2
 \square 12 x 6 mm
H 250 mm
L 250 mm



Art. 30/4
 Φ 6 x 6 mm
Ø 153 mm



Art. 30/7
 \square 10 x 5 mm
Ø 160 mm

GHISA - CAST IRON

Art. 756/1

H 460 x L 265 mm
spess./thickn. 32 mm
foro filetto M6
threades hole M6



Art. 756/3

H 385 x L 210 mm
spess./thickn. 32 mm
foro filetto M6
threades hole M6

Art. 756/7

H 300 x L 170 mm
spess./thickn. 32 mm
foro filetto M6
threades hole M6

Art. 756/5

H 550 x L 295 mm
spess./thickn. 23 mm
2 fori filetto M5
2 threades holes M5

Art. 756/10

H 470 x L 195 mm
spess./thickn. 20 mm
2 fori filetto M5
2 threades holes M5



Art. 756/11

H 230 x L 220 mm
spessore/thickness 20 mm



Art. 757/3

H 400 x L 235 mm
spessore/thickness 40 mm
Alluminio-Aluminium
Foro-hole M4

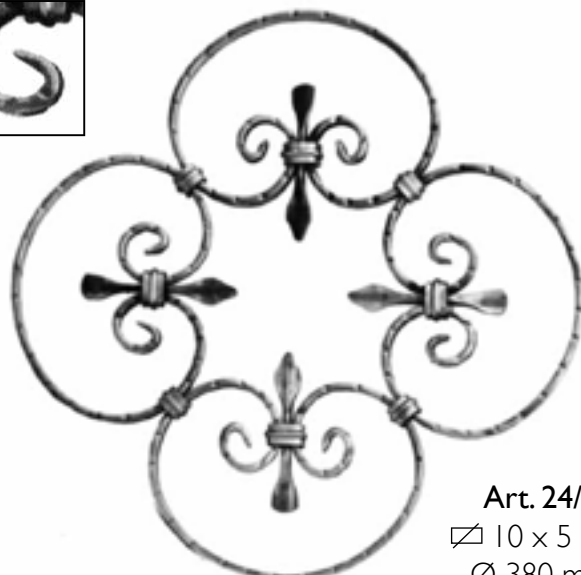

Art. 24/1
10 x 5 mm
Ø 380 mm

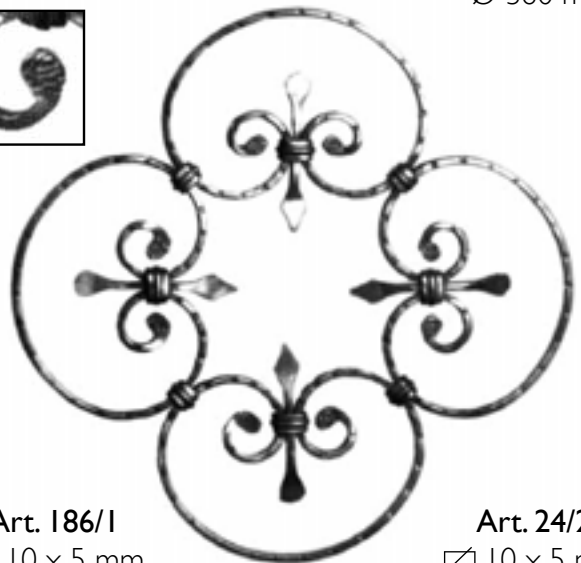

Art. 186/1
10 x 5 mm
Ø 380 mm
Zincato a caldo
Hot galvanized

Art. 24/2
10 x 5 mm
Ø 380 mm

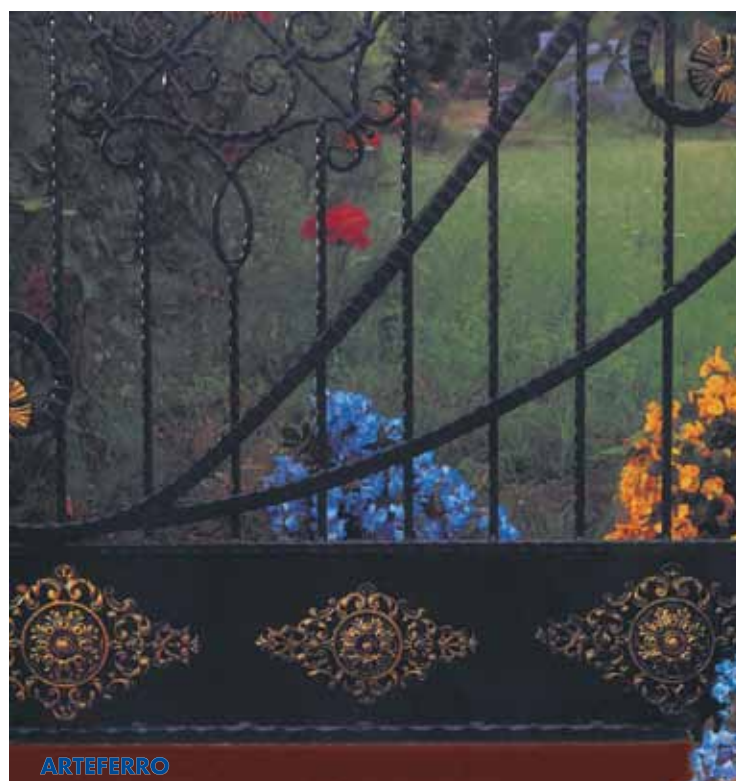

estremità battute a caldo
hot forged ends



Art. 1657/4

▧ 16 x 8 mm
H 575 mm
L 400 mm

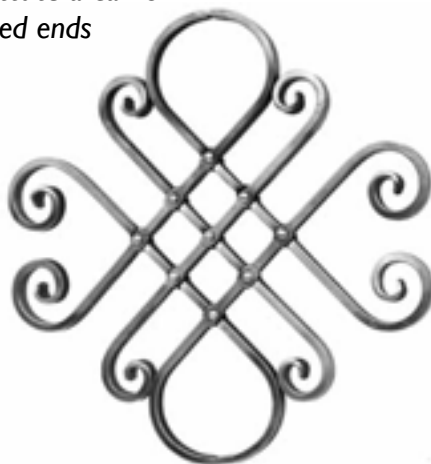

Articolo non vendibile in Spagna
Article not for sale in Spain

Art. 1657/I

▧ 16 x 8 mm
H 400 mm
L 410 mm

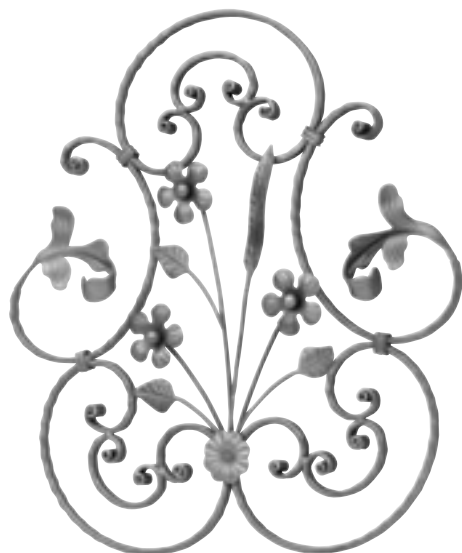

spigolato/hammered on edges

Art. NEW0003

▧ 16 x 8 mm
H 710 mm
L 670 mm



Ricci - Scrolls ▧ 14 x 8 mm

Art. NEW0005

⌀ 14 x 14 mm
H 700 mm
L 600 mm



Art. NEW0001

▧ 14 x 8 mm
Ø 500 mm

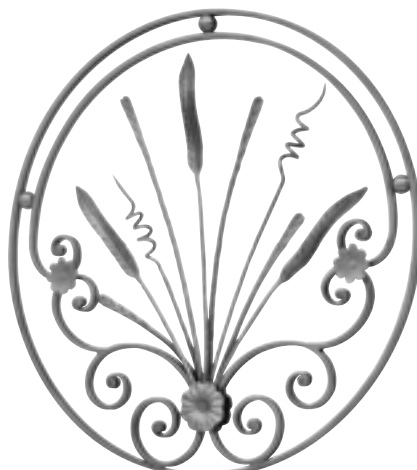

Art. NEW0002

▧ 14 x 8 mm
Ø 630 mm



ARTEFERRO

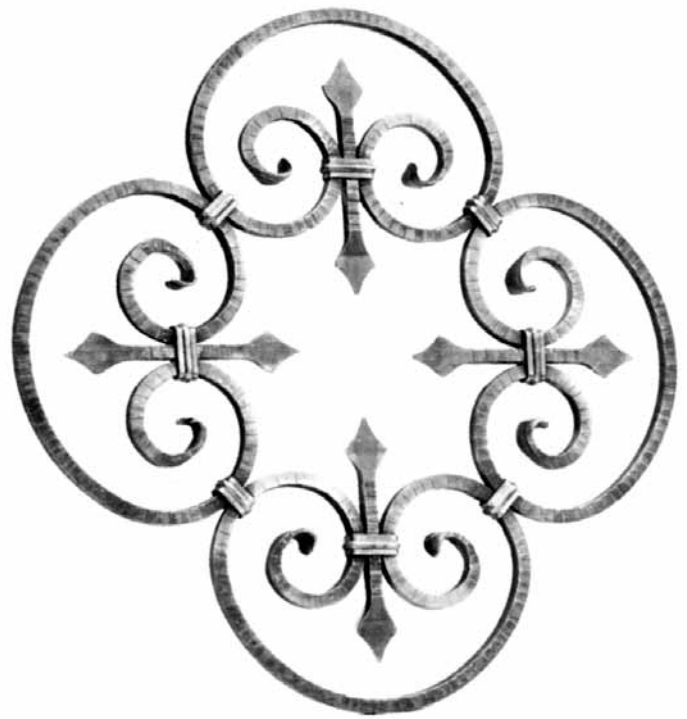

Art. 24/3
 Φ 12 x 12 mm
 Φ 600 mm



Art. 21/5
 \square 14 x 8 mm
 Φ 275 mm



Art. 1017/3
 Φ 12 mm
 Φ 220 mm



Art. 1010/3
 Φ 12 x 12 mm
 Φ 290 mm



Art. 1017/4
 Φ 12 mm
 Φ 275 mm

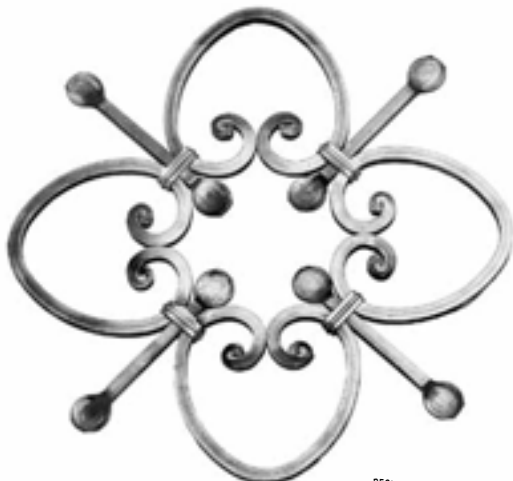

Art. 1010/1
 Φ 12 x 12 mm
 Φ 490 mm

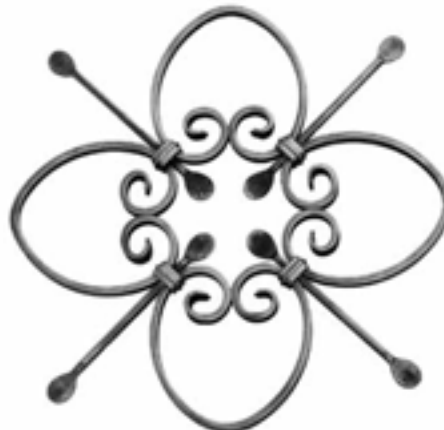

Art. 1009/2
 \square 12 x 6 mm
 Φ 370 mm



Art. 1009/1
 \square 12 x 6 mm
 Φ 360 mm





Art. I659/1
 Φ 14 x 14 mm
 Ø 450 mm



ARTEFERRO



Art. NEW0008
 ▧ 12 x 6 mm
 H 200 mm
 L 200 mm



Ø 270 mm
Art. I014/1
 Φ 12 x 12 mm



Art. I015/2
 ▧ 14 x 8 mm
 Ø 295 mm



Art. GD211/2
 Φ 12 x 12 mm
 H 395 mm
 L 395 mm



Art. NEW0007
 ▧ 12 x 6 mm
 H 320 mm
 L 320 mm



Art. NEW0006
 ▧ 12 x 6 mm
 Ø 290 mm



Ø 295 mm
Art. I013/2
 Φ 12 x 12 mm

Art. I013/1
 Ø 12 mm



Art. NEW0011
 ∅ 16 x 6 mm
 H 260 mm
 L 260 mm

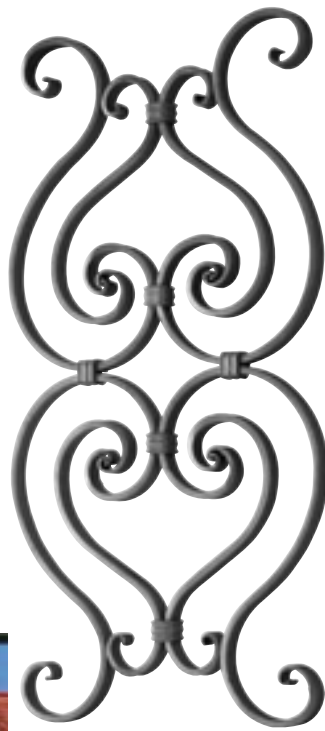

Art. NEW0010
 ∅ 16 x 6 mm
 H 515 mm
 L 260 mm

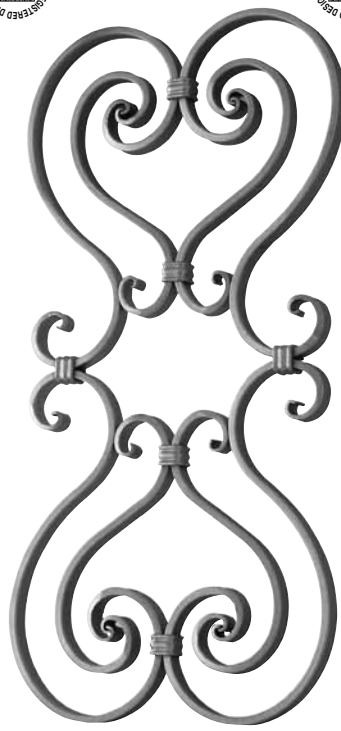

Art. NEW0009
 ∅ 16 x 6 mm
 H 515 mm
 L 260 mm

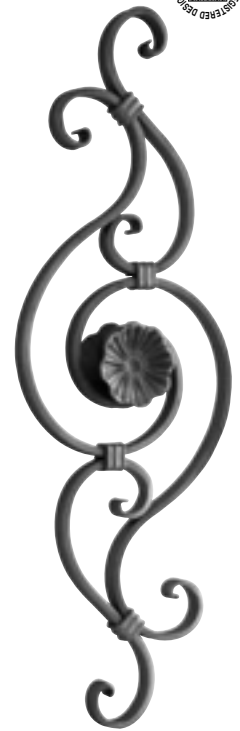

Art. NEW0016
 ∅ 16 x 6 mm
 H 510 mm
 L 175 mm



ARTEFERRO

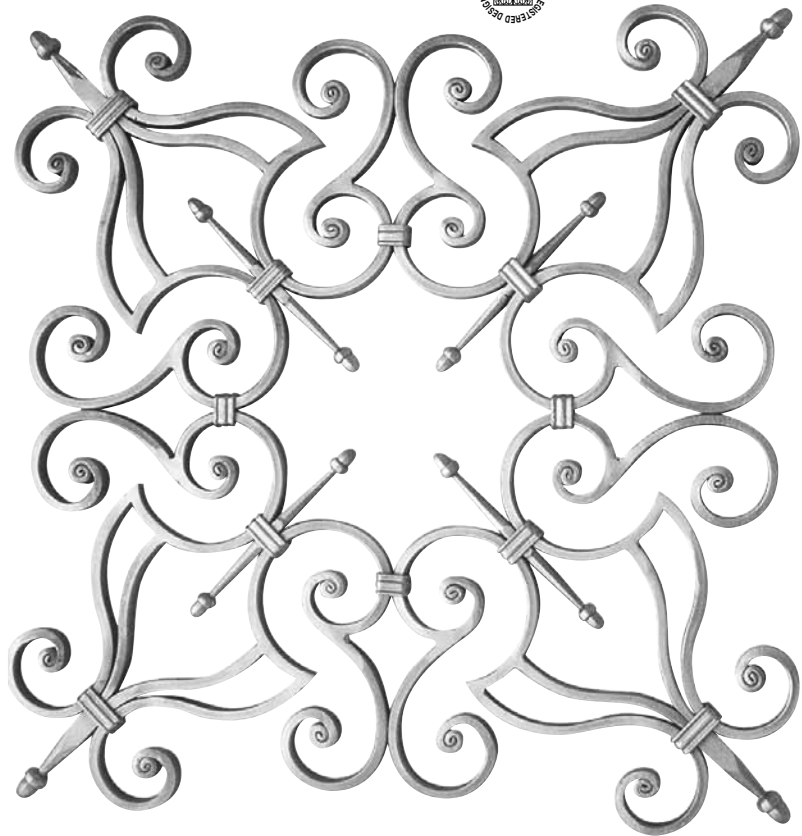

Art. GD151/2
 ∅ 14 x 8 mm
 L 550 mm - ∅ 770 mm

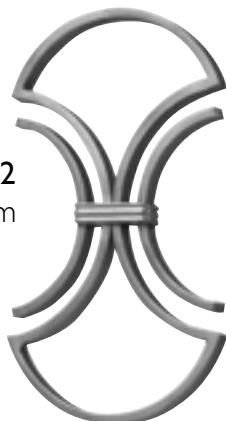

Art. GD187/2
 ∅ 14 x 8 mm
 H 325 mm
 L 190 mm



Art. 446/4
 Ø 14 mm
 Ø 565 mm



Art. 1012/I
 Ø 12 mm
 Ø 560 mm



Art. 1028/2
 12 x 12 mm
 Ø 630 mm



Art. 1028/I
 12 x 12 mm
 Ø 420 mm



Art. 1642/I
 12 x 6 mm
 Ø 650 mm

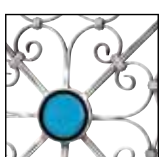

con medaglia in vetro
with glass embellishment
Art. 1643/I

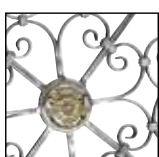

con medaglia in
 ottone su due lati
*with solid brass
 embellishment on two sides*
Art. 1644/I



con medaglia in
 legno su due lati
*with wooden
 embellishment on two sides*
Art. 1645/I

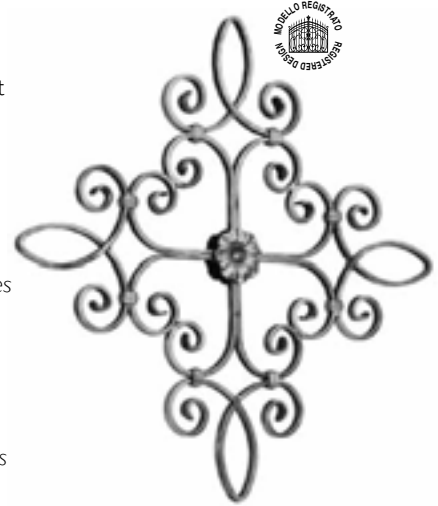

Art. 1647/I
 12 x 6 mm
 H 610 mm
 L 440 mm



ARTEFERRO

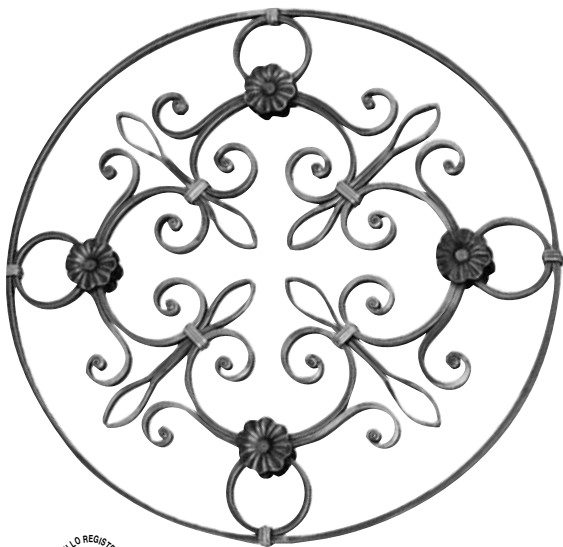

rosetta su due lati
rosette on two sides

Art. 1667/3

▧ 14 x 8 mm

Ø 685 mm



Art. 1648/1

▧ 16 x 8 mm

Ø 760 mm



Art. 1668/2

▧ 14 x 8 mm

Ø 525 mm

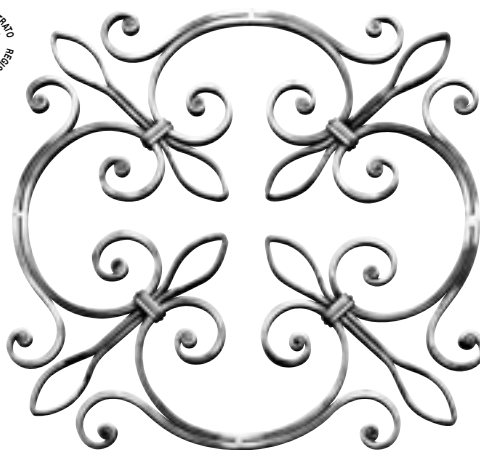

Art. 1667/2

▧ 14 x 8 mm

Ø 590 mm

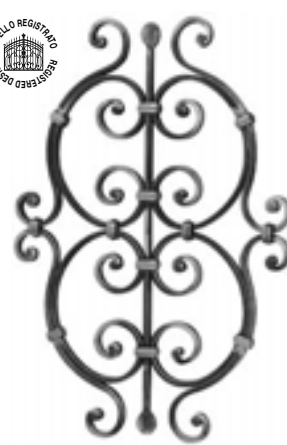

Art. 1668/1

▧ 14 x 8 mm

H 575 mm

L 400 mm



ARTEFERRO

con medaglia in vetro
with glass embellishment

Art. 1021/1

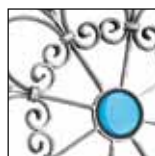

con medaglia in
ottone su due lati
with solid brass
embellishment on two sides

Art. 1022/1

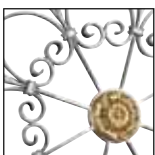

con medaglia in
legno su due lati
with wooden
embellishment on two sides

Art. 1023/1



Art. 1020/1

▧ 12 x 6 mm

Ø 590 mm



H 210 x L 210 mm

Art. 1665/14
Φ 14 x 14 mm

Art. 1665/15
Φ 16 x 16 mm

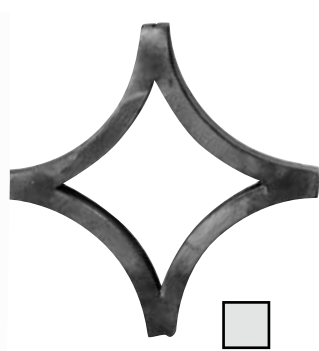

H 180 x L 180 mm

Art. 1665/10
Φ 14 x 14 mm

Art. 1665/11
Φ 16 x 16 mm



Articolo non vendibile in Spagna
Article not for sale in Spain

H 210 x L 210 mm

Art. 1665/12
Φ 14 x 14 mm

Art. 1665/13
Φ 16 x 16 mm

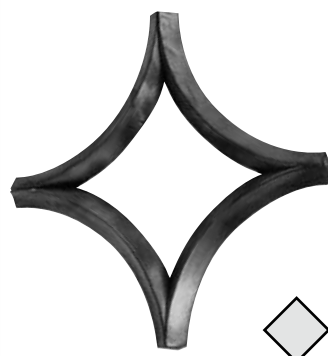

H 190 x L 190 mm

Art. 1665/8
Φ 14 x 14 mm

Art. 1665/9
Φ 16 x 16 mm



H 380 x L 180 mm

Art. 1665/6
Φ 14 x 14 mm

Art. 1665/7
Φ 16 x 16 mm



H 390 x L 200 mm

Art. 1665/16
Φ 14 x 14 mm

Art. 1665/17
Φ 16 x 16 mm



H 340 x L 200 mm

Art. 1665/18
Φ 14 x 14 mm

Articolo non vendibile in Spagna
Article not for sale in Spain



H 380 x L 180 mm

Art. 1665/4
Φ 14 x 14 mm

Art. 1665/5
Φ 16 x 16 mm



Art. 1659/2
Φ 14 x 14 mm
Ø 245 mm



ARTEFERRO

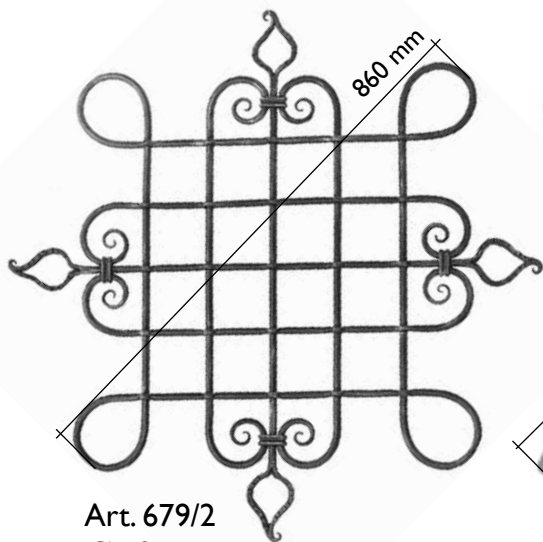

Art. 679/2
 Ø 12 mm
 630 x 630 mm

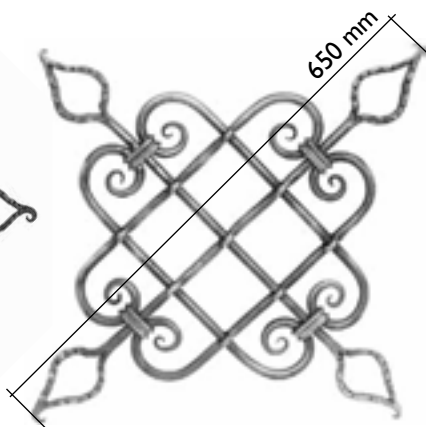

Art. 679/1
 Ø 12 mm
 470 x 470 mm

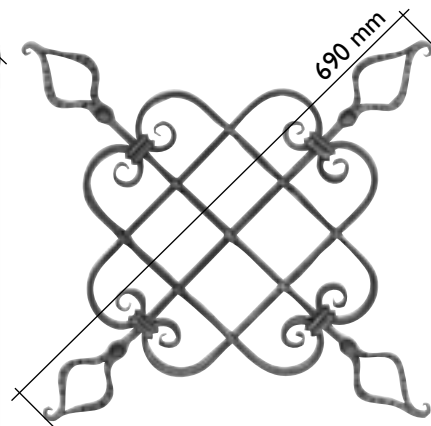

Art. 680/1
 16 x 8 mm
 500 x 500 mm

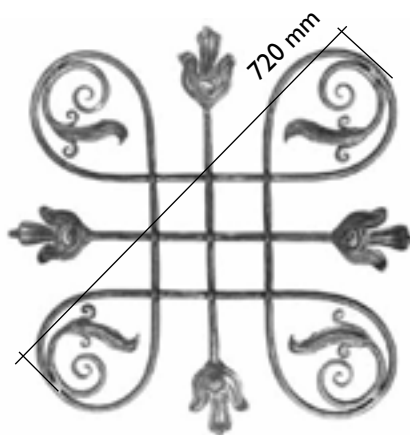

Art. 679/3
 Ø 12 mm
 630 x 630 mm

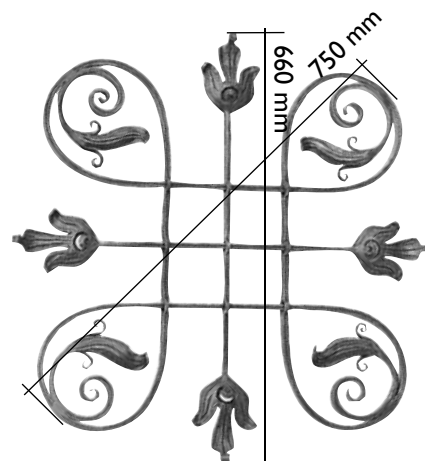

Art. 680/2
 16 x 8 mm
 590 x 590 mm



Art. 720/2
 12 x 6 mm
 Ø 415 mm



Art. 719/1
 14 x 14 mm
 H 690 mm
 L 515 mm



Art. 720/1
 14 x 14 mm
 H 670 mm
 L 515 mm



Ø 250 mm
 ▧ 20 x 4 mm
 con fascette/with collars
Art. 23/3
 senza fascette/without collars
Art. 23/2



Ø 250 mm
 ⌀ 8 x 8 mm
 con fascette/with collars
Art. 19/5
 senza fascette/without collars
Art. 19/6

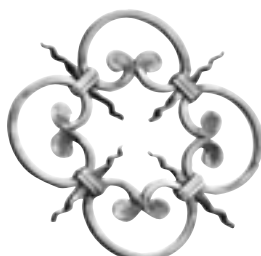

Ø 260 mm
 ⌀ 8 x 8 mm
 con fascette/with collars
Art. 16/1
 senza fascette/without collars
Art. 16/2



Ø 250 mm
 ⌀ 8 x 8 mm
 con fascette/with collars
Art. 20/1
 senza fascette/without collars
Art. 20/2

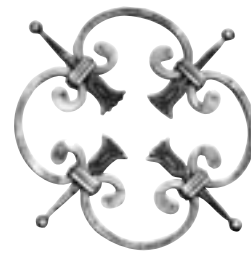

Ø 250 mm
 ⌀ 8 x 8 mm
 con fascette/with collars
Art. 19/3
 con fascette/with collars
Art. 19/4



Ø 300 mm
 ⌀ 8 x 8 mm
 con fascette/with collars
Art. 18/3
 senza fascette/without collars
Art. 18/4

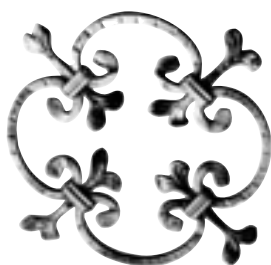

Ø 250 mm
 ⌀ 8 x 8 mm
 con fascette/with collars
Art. 20/5
 senza fascette/without collars
Art. 20/6
Art. 186/2
 Zincato a caldo
 Hot galvanized

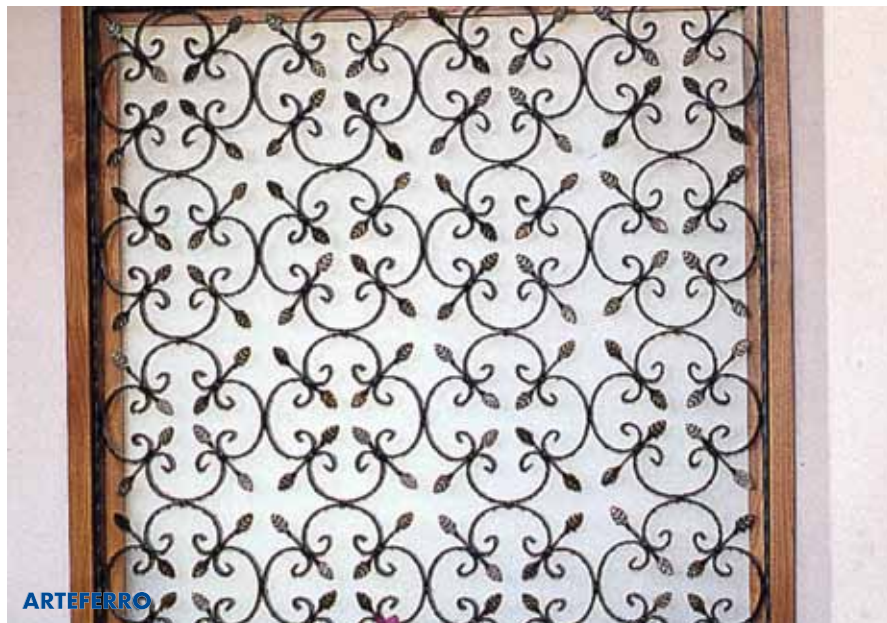

ARTEFERRO

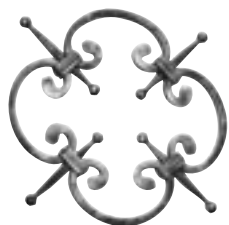

⌀ 8 x 8 mm
 Ø 250 mm
 con fascette/with collars
Art. 20/3
 senza fascette/without collars
Art. 20/4

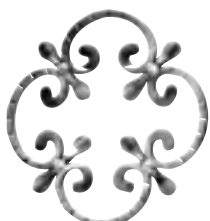

Art. 16/3
 ⌀ 8 x 8 mm
 Ø 250 mm



Art. 22/B/4
 ▧ 20 x 3 mm
 Ø 250 mm

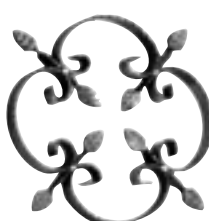

Art. 22/B/3
 ▧ 20 x 3 mm
 Ø 250 mm

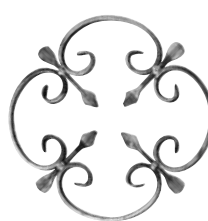

Art. 454/2
 ▧ 12 x 6 mm
 Ø 255 mm

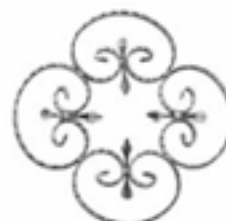

Art. 454/3
 ▧ 10 x 5 mm
 Ø 255 mm



fiore placcati oro 24K
 24 gold plated flowers
Art. 22/C/1
 ▧ 20 x 3 mm
 Ø 250 mm

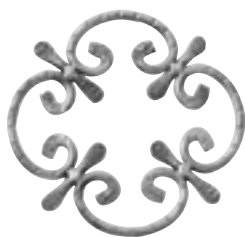

Ø 260 mm
Art. 26/1
 Ø 10 mm
Art. 26/2
 Ø 8 mm

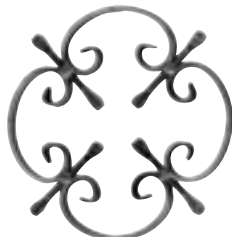

Art. 454/7
 ▧ 12 x 6 mm
 Ø 260 mm

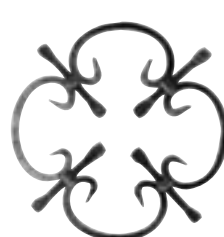

Art. 454/8
 ⌀ 8 x 8 mm
 Ø 250 mm

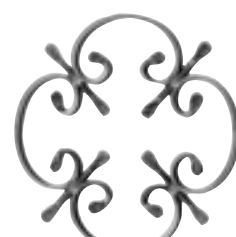

Art. 454/6
 ▧ 12 x 6 mm
 Ø 270 mm

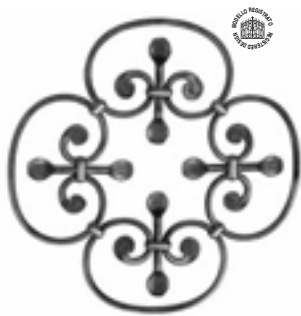

Art. 1011/1
Ø 10 mm
Ø 440 mm



Art. 1655/1
12 x 6 mm
Ø 430 mm



Art. 1011/2
12 x 12 mm
Ø 610 mm



Art. 452/1
14 x 14 mm
Ø 610 mm



ARTEFERRO



con medaglia in ottone
with solid brass embellish.

Art. 1650/1



con medaglia in legno
with solid brass embellish.

Art. 1651/1

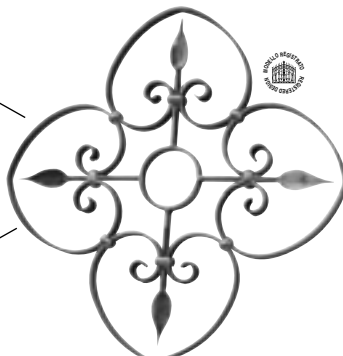

Art. 1649/1
20 x 6 mm
Ø 560 mm

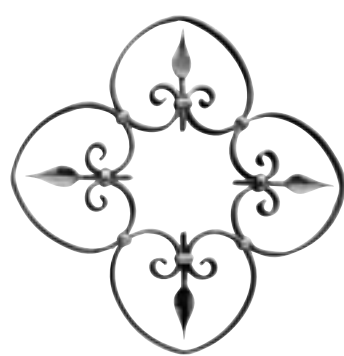

Art. 1639/1
20 x 6 mm
Ø 560 mm
L 450 mm

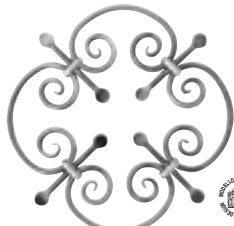

Art. 455/2
Ø 12 mm
Ø 450 mm

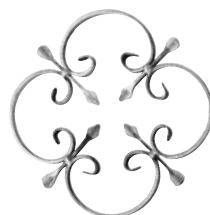

Art. 454/1
12 x 6 mm
Ø 300 mm

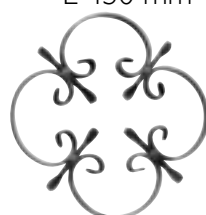

Art. 454/5
12 x 6 mm
Ø 300 mm

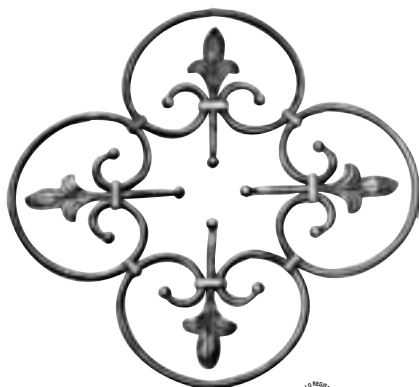

Art. 447/1
Ø 14 mm
Ø 620 mm



Art. 24/C/3
10 x 5 mm
Ø 450 mm

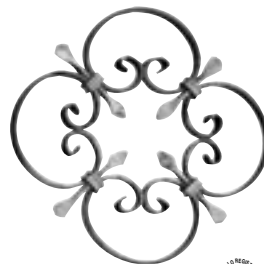

Art. 446/1
12 x 6 mm
Ø 350 mm

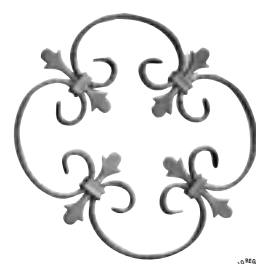

Art. 446/2
12 x 6 mm
Ø 320 mm

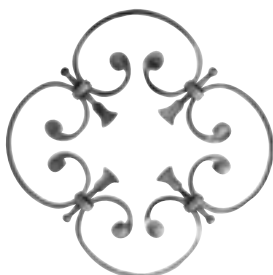

Art. 448/1
8 x 8 mm
Ø 435 mm







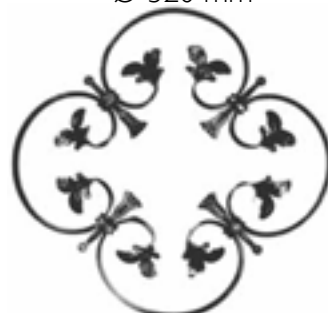

Art. 449/1
12 x 6 mm
Ø 430 mm





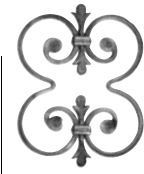
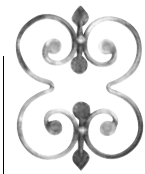

Art. 450/1
12 x 6 mm
Ø 420 mm

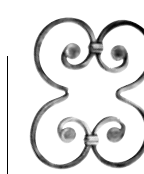

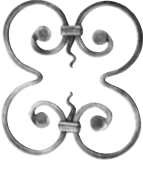
Art. 24/B/1
12 x 6 mm
Ø 460 mm

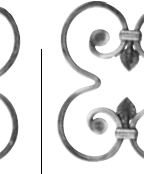
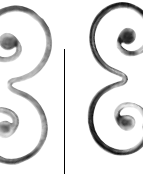
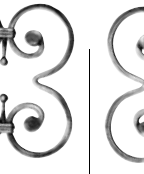
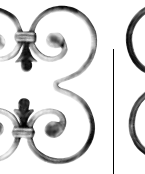
Φ 8 mm H 235 mm L 215 mm Ø 270 mm								
	Cod.art./Art.no.	Cod.art./Art.no.	Cod.art./Art.no.	Cod.art./Art.no.	Cod.art./Art.no.	Cod.art./Art.no.	Cod.art./Art.no.	Cod.art./Art.no.
senza fascette without collars	27/13	27/1	27/11	27/9	27/5	27/7	27/3	29/4
con fascette with collars	27/14	27/2	27/12	27/10	27/6	27/8	27/4	29/5

Φ 8 mm H 235 mm L 215 mm Ø 270 mm							
	Cod.art./Art.no.	Cod.art./Art.no.	Cod.art./Art.no.	Cod.art./Art.no.	Cod.art./Art.no.	Cod.art./Art.no.	Cod.art./Art.no.
senza fascette without collars	-	-	-	-	-	-	-
con fascette with collars	28/1	28/2	28/4	29/1	29/3	28/3	29/2



Art. 453/7

▣ 12 x 6 mm
Ø 245 mm

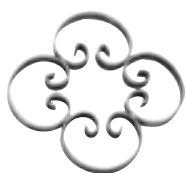

Art. 453/1

▣ 16 x 4 mm
Ø 235 mm

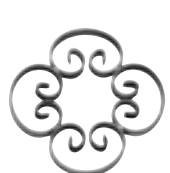

Art. 453/2

▣ 16 x 4 mm
Ø 210 mm



Art. 453/3

▣ 12 x 6 mm
Ø 210 mm



Art. 454/4

▣ 12 x 6 mm
Ø 240 mm

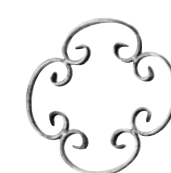

Art. 453/4

▣ 12 x 6 mm
Ø 245 mm



Art. 1648/3

▣ 16 x 8 mm
Ø 320 mm



Art. 453/5

▣ 12 x 6 mm
Ø 295 mm



Art. 453/6

▣ 12 x 6 mm
Ø 215 mm



Art. 1648/4

▣ 16 x 8 mm
Ø 240 mm



Art. 1648/2

▣ 16 x 8 mm
Ø 320 mm

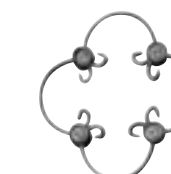

Art. 160/E/3

▣ 10 x 5 mm
Ø 275 mm



Art. 1017/1

▣ 12 x 6 mm
Ø 285 mm

fiore in ottone su due lati
brass flower on two sides

Art. 1017/2

▣ 12 x 6 mm
Ø 230 mm



Art. 33/1

▣ 12 x 6 mm
Ø 250 mm



Art. 22/A/2

Φ 8 x 8 mm
H 210 mm
L 210 mm



Ø 250 mm
Art. 26/3

▣ 16 x 4 mm

Art. 26/4

▣ 20 x 4 mm

Art. 26/5

▣ 20 x 6 mm



Ø 225 mm
Art. 31/1

▣ 12 x 6 mm

Art. 31/2

▣ 20 x 6 mm

Art. 31/3

▣ 35 x 5 mm

Ø 230 mm
Art. 31/4

Φ 8 x 8 mm

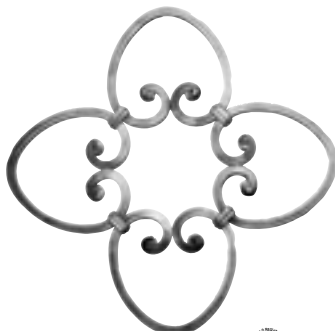

Art. 1010/2

Φ 12 x 12 mm
Ø 445 mm

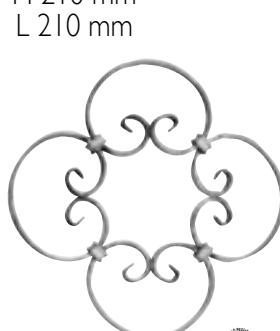

Art. 446/3

▣ 12 x 6 mm
Ø 340 mm



Art. 1393/2

Ø 112 mm
spess./ thickn. 14 mm



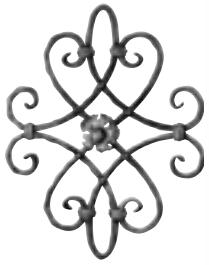

Art. 160/E/2
fiore in ottone su un lato
brass flower on two sides

Art. 160/E/4
fiore in ottone su due lati
brass flower on two sides

12 x 12 mm
H 480 mm
L 400 mm



Art. 456/2
∅ 12 x 6 mm
H 545 mm
L 485 mm

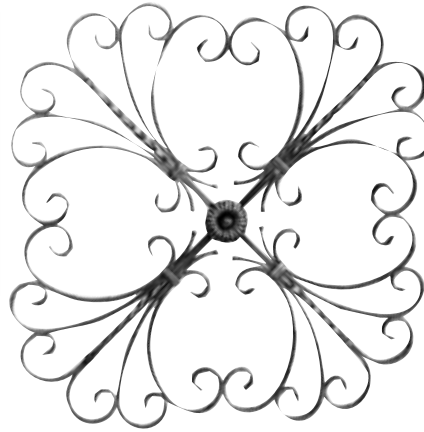

Art. 457/1
∅ 12 x 6 mm
H 1020 mm
L 1020 mm

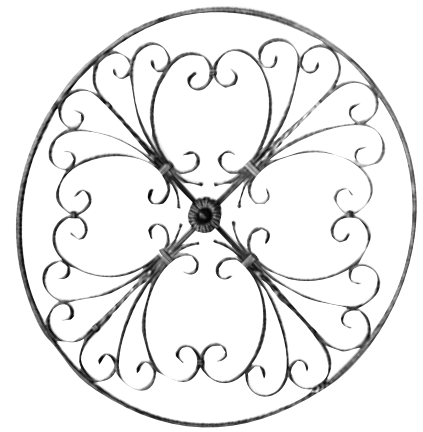

Cerchio - Ring ∅ 12 x 12 mm

Art. 457/2
∅ 12 x 6 mm
∅ 1045 mm



ARTEFERRO



Art. 1668/3
∅ 14 x 8 mm
∅ 450 mm

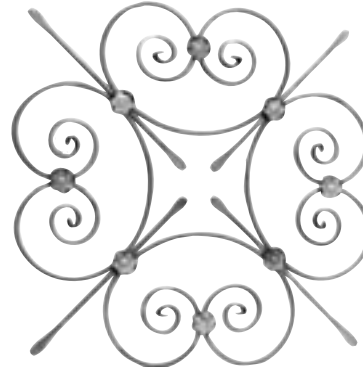

Art. 26/A/1
∅ 10 x 10 mm
H 810 mm
L 810 mm

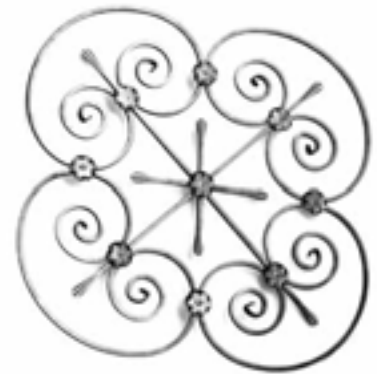

Art. 26/B/2
∅ 10 x 10 mm
H 810 mm
L 810 mm

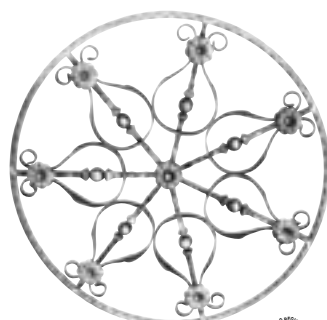

Art. 718/1
∅ 14 x 14 mm
∅ 735 mm

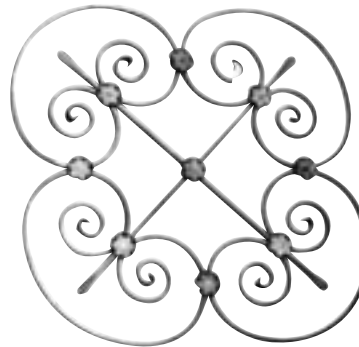

Art. 26/B/1
∅ 10 x 10 mm
H 810 mm
L 810 mm

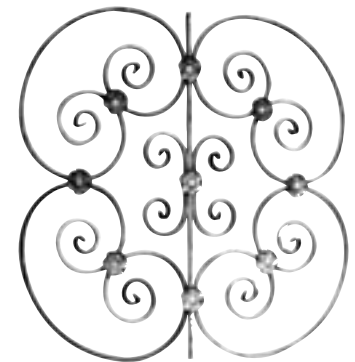

Art. 26/A/2
∅ 10 x 10 mm
H 810 mm
L 810 mm

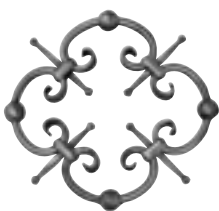

Art. 1014/3
∅ 12 mm
∅ 270 mm

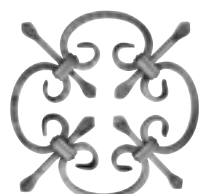

Art. 1015/1
∅ 8 x 8 mm
∅ 275 mm

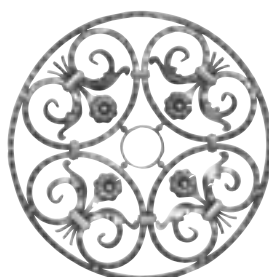

Art. 459/1
∅ 14 x 14 mm
∅ 610 mm

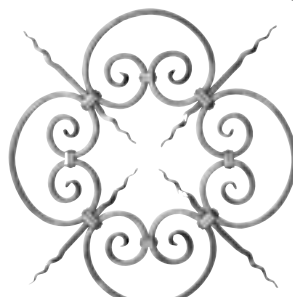

Art. 1012/2
∅ 12 x 12 mm
∅ 730 mm

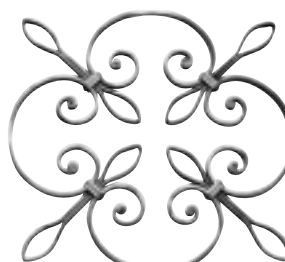

Art. 1667/1
∅ 14 x 8 mm
∅ 590 mm

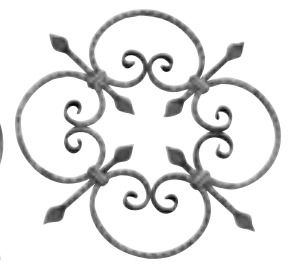

Art. 1011/3
∅ 12 x 12 mm
∅ 555 mm



Art. 719/2
 □ 16 x 8 mm
 H 710 mm
 L 640 mm



Ø 240 mm
Art. 1019/1
 Ø 12 mm
Art. 1019/2
 □ 12 x 12 mm
Art. 1019/3
 ⊗ 12 x 12 mm

Ø 315 mm
Art. 1019/4
 Ø 12 mm
Art. 1019/5
 □ 12 x 12 mm
Art. 1019/6
 ⊗ 12 x 12 mm

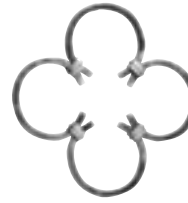

Ø 250 mm
 □ 8 x 8 mm
Art. 22/1
 con fascette
 with collars
Art. 22/2
 senza fascette
 without collars



Art. 21/4
 □ 8 x 8 mm
 Ø 250 mm

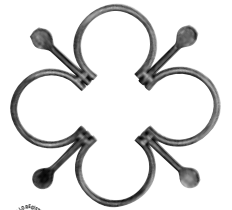

Art. 1019/7
 Ø 12 mm
 Ø 360 mm
Art. 1019/8
 □ 12 x 12 mm
 Ø 360 mm
Art. 1019/9
 Ø 12 mm
 Ø 360 mm



Art. 22/3
 □ 10 x 5 mm
 Ø 290 mm



Art. 22/A/1
 □ 8 x 8 mm
 Ø 240 mm



Art. 22/B/1
 □ 10 x 5 mm
 Ø 250 mm

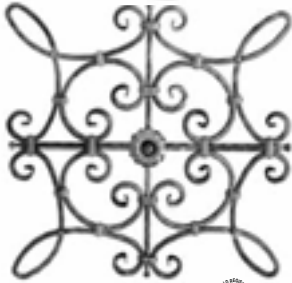

Art. 480/1
 □ 12 x 12 mm
 H 660 mm
 L 660 mm



Art. 461/1
 □ 12 x 12 mm
 H 390 mm
 L 460 mm



Art. 460/1
 □ 12 x 12 mm
 H 550 mm
 L 460 mm



Art. 460/2
 □ 12 x 12 mm
 H 600 mm
 L 460 mm

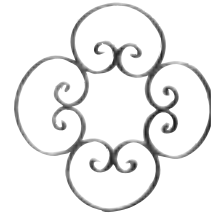

Art. 24/C/1
 □ 10 x 5 mm
 Ø 380 mm

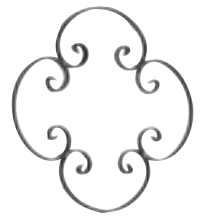

Art. 24/C/2
 □ 10 x 5 mm
 Ø 380 mm



Art. 1653/1
 □ 12 x 6 mm
 Ø 250 mm



Art. 1652/5
 □ 12 x 6 mm
 Ø 250 mm

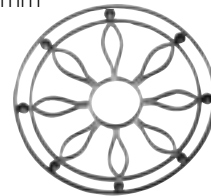
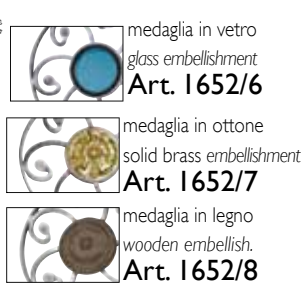

Art. 1661/1
 □ 12 x 6 mm
 Ø 370 mm



Art. 1653/2
 □ 12 x 6 mm
 Ø 250 mm



Art. 1652/1
 12 x 6 mm
 Ø 250 mm

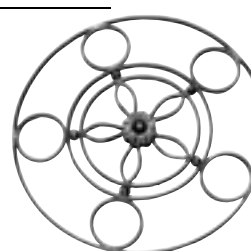

Art. 1661/5
 12 x 6 mm
 Ø 500 mm

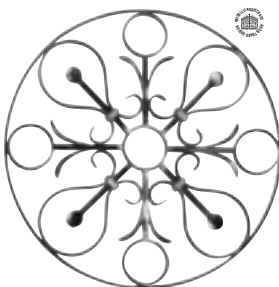

Art. 1024/1
 □ 12 x 6 mm
 Ø 615 mm

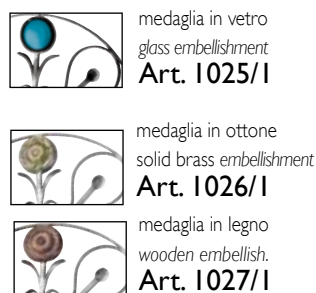

Art. 24/E/1
 □ 12 x 12 mm
 Ø 600 mm

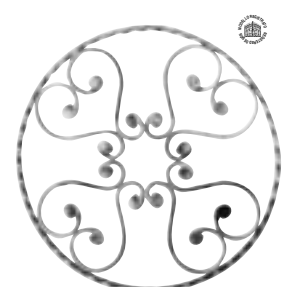

Art. 451/1
 □ 8 x 8 mm
 Ø 575 mm

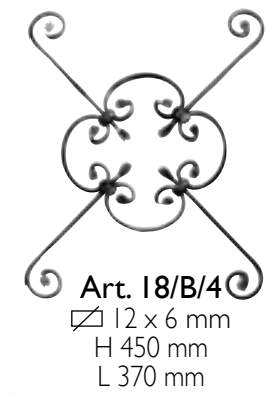

Art. 18/B/4
12 x 6 mm
H 450 mm
L 370 mm

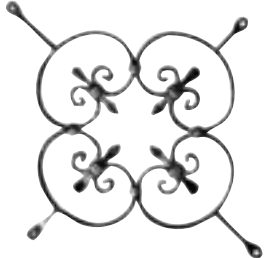

Art. 162/2
10 x 5 mm
H 580 mm
L 510 mm

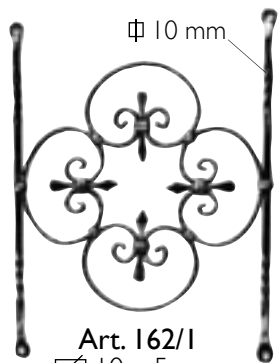

Art. 162/1
10 x 5 mm
H 510 mm
L 400 mm

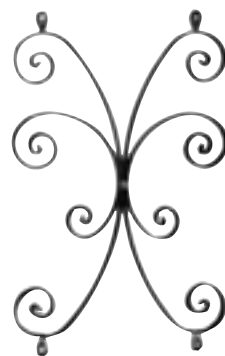

Art. 162/3
16 x 4 mm
H 530 mm
L 350 mm

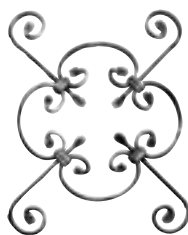

Art. 18/B/1
12 x 6 mm
H 350 mm
L 270 mm



12 x 6 mm
Art. 1323/12

H 100 mm
L 100 mm
Ø 110 mm

Art. 1323/13
H 140 mm
L 140 mm
Ø 160 mm



Art. 1323/3
12 x 6 mm
H 130 mm
L 100 mm



12 x 6 mm
Art. 1323/14

Ø 100 mm
Art. 1323/15
Ø 170 mm



12 x 6 mm
Art. 1323/10
H 95 mm
L 95 mm

Art. 1323/11
H 140 mm
L 140 mm



12 x 6 mm
Art. 1323/4

Ø 130 mm
L 100 mm
Art. 1323/5
Ø 185 mm
L 140 mm

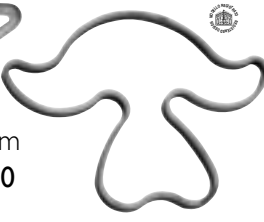

Art. 1323/1
12 x 6 mm
H 225 mm
L 295 mm



12 x 6 mm
Art. 1323/8

Ø 100 mm
L 80 mm
Art. 1323/9
Ø 128 mm
L 100 mm



Art. 1323/2
12 x 6 mm
H 180 mm
L 80 mm



12 x 6 mm
Art. 1323/6

H 120 mm
L 80 mm
Art. 1323/7
H 170 mm
L 100 mm



Art. 1122/7
12 x 6 mm
H 280 mm
L 135 mm

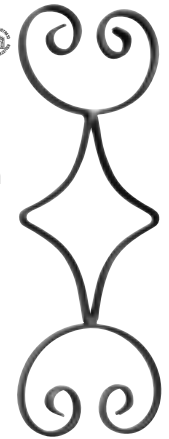

Art. 1665/19
14 x 6 mm
H 440 mm
L 150 mm

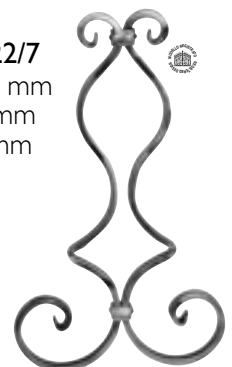

Art. 471/2
14 x 8 mm
H 425 mm
L 250 mm



Art. 1647/4
12 x 6 mm
H 160 mm
L 200 mm



stella in ottone
brass star
Art. 790/3
14 x 8 mm
H 240 mm
L 240 mm



Art. 636/4
12 x 12 mm
H 350 mm
L 500 mm



Art. 92/A/3
12 x 6 mm
H 330 mm
L 163 mm



Art. 1647/5
12 x 6 mm
H 250 mm
L 200 mm

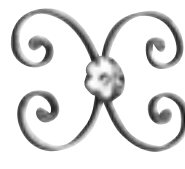

Art. 22/A/3
12 x 6 mm
H 240 mm
L 170 mm



Art. 33/3
16 x 4 mm
H 250 mm
L 250 mm

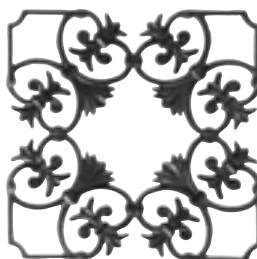

ghisa/cast iron
Art. 34/1
12 x 6 mm
H 350 mm
L 350 mm



Art. 1393/1
H 185 mm
L 100 mm
Ø 270 mm
spess./thickn. 14 mm



Art. 515/2
14 x 8 mm
H 240 mm
L 235 mm



medaglia in ottone
solid brass embellish.
Art. 515/1
14 x 8 mm
H 240 mm
L 235 mm



Art. 52/H/3
12 x 6 mm
H 300 mm
L 120 mm



Art. 1661/9
12 x 6 mm
Ø 285 mm



Art. 30/2
16 x 4 mm
Ø 250 mm



Art. 30/3
16 x 4 mm
Ø 250 mm



Art. 30/1
16 x 4 mm
Ø 250 mm

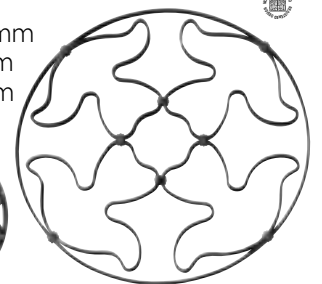

Art. 1639/4
12 x 6 mm
Ø 550 mm



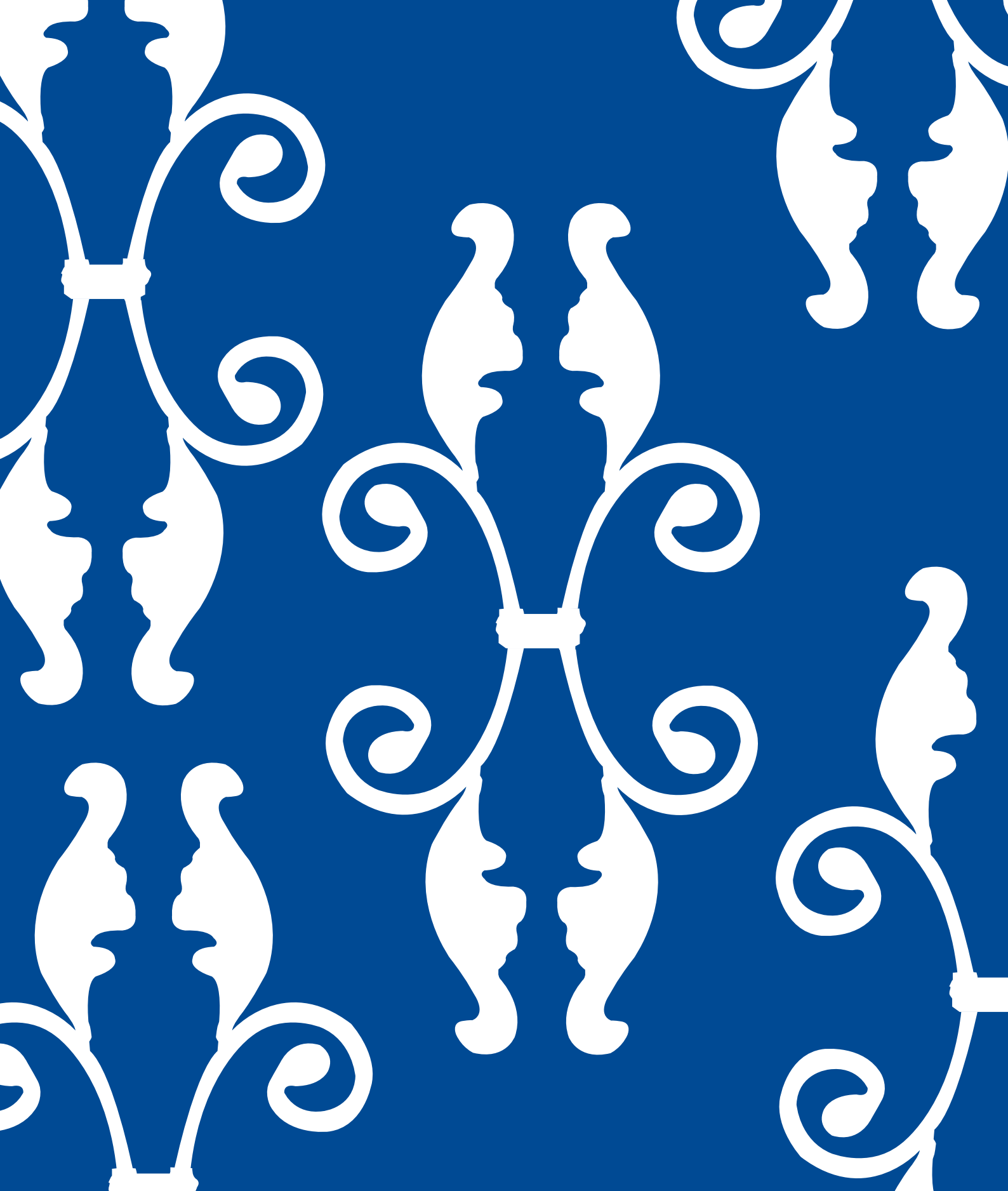

SNAP-ONS

COMPENDIUM 2011



Art. 36/2
 Ø 12 x 6 mm
 H 380 mm
 L 230 mm



Art. 1300/4
 Ø 12 x 6 mm
 H 380 mm
 L 175 mm

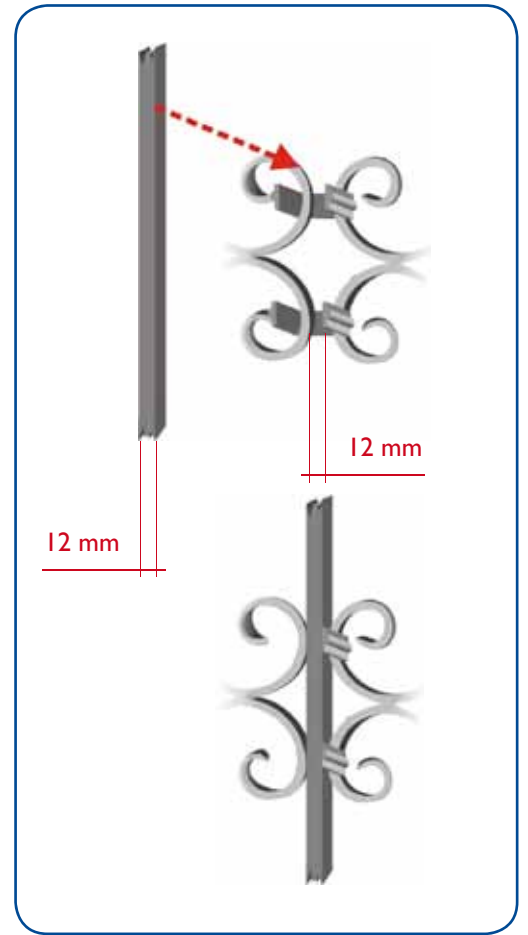

Art. 35/1
 Ø 12 x 6 mm
 H 445 mm
 L 205 mm



ARTEFERRO



Art. 583/3
 ∅ 12 x 6 mm
 H 120 mm
 L 145 mm



Art. 37/3
 ∅ 12 x 6 mm
 H 95 mm
 L 95 mm



Art. 1300/1
 ∅ 12 x 6 mm
 H 95 mm
 L 145 mm

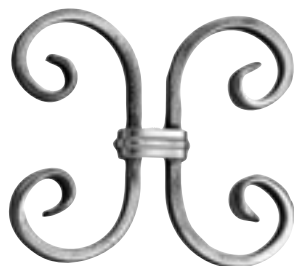

Art. 1300/3
 ∅ 12 x 6 mm
 H 120 mm
 L 135 mm

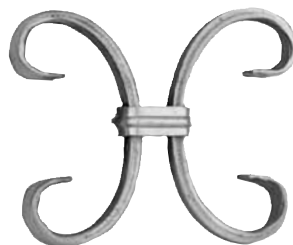

Art. 582/3
 ∅ 12 x 6 mm
 H 110 mm
 L 140 mm



Art. 582/2
 ∅ 12 x 6 mm
 H 160 mm
 L 170 mm

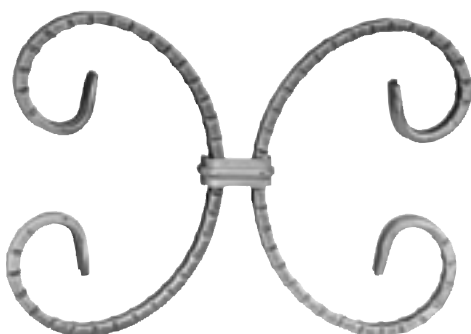

Art. 583/2
 ∅ 12 x 6 mm
 H 190 mm
 L 215 mm

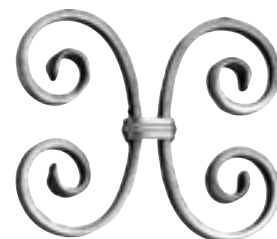

Art. 1300/2
 ∅ 12 x 6 mm
 H 145 mm
 L 175 mm

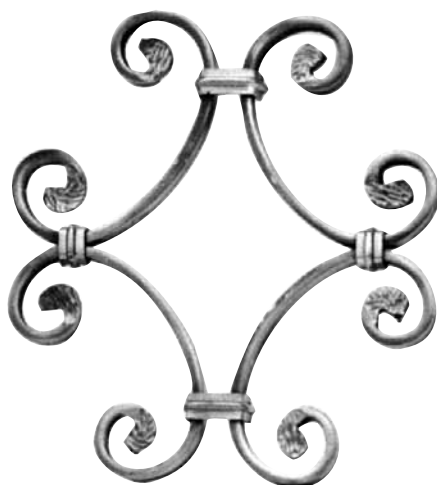

Art. 36/1
 ∅ 12 x 6 mm
 H 250 mm
 L 220 mm



Art. 582/1
 ∅ 12 x 6 mm
 H 350 mm
 L 175 mm



Art. 583/4
 Ø 12 x 6 mm
 H 230 mm
 L 110 mm



Art. 35/2
 Ø 12 x 6 mm
 H 345 mm
 L 200 mm

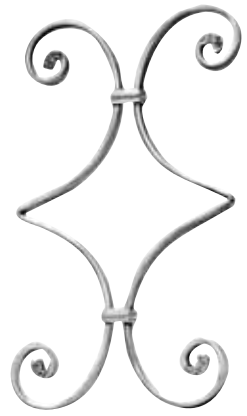

Art. 36/3
 Ø 12 x 6 mm
 H 385 mm
 L 230 mm

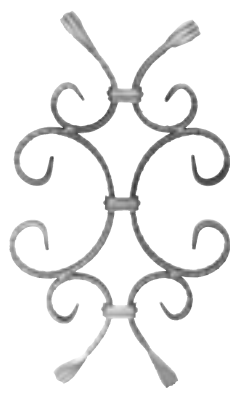

Art. 583/1
 Ø 12 x 6 mm
 H 370 mm
 L 210 mm



Art. 37/1
 Ø 12 x 6 mm
 H 440 mm
 L 160 mm



Art. 37/2
 Ø 12 x 6 mm
 H 420 mm
 L 200 mm

GHISA - CAST IRON

saldabile, non zincabile
weldable - galvanizing is not recommended



Art. 753/8
 Ø 12 x 12 mm
 H 195 mm
 L 75 mm



Art. 753/9
 Ø 12 x 12 mm
 H 105 mm
 L 105 mm

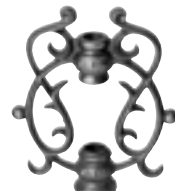

Art. 753/7
 Ø 16 mm
 H 170 mm
 L 145 mm



Art. 753/6
 Ø 16 mm
 H 195 mm
 L 125 mm



ARTEFERRO



Art. 753/1
 Ø 12 x 12 mm
 H 380 mm
 L 195 mm

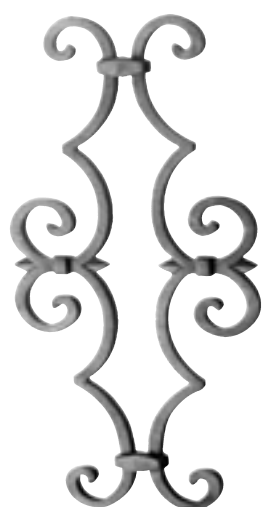

Art. 753/3
 Ø 12 x 12 mm
 H 450 mm
 L 190 mm



Art. 753/2
 Ø 12 x 12 mm
 H 305 mm
 L 165 mm

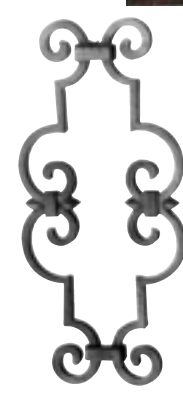

Art. 753/4
 Ø 12 x 12 mm
 H 360 mm
 L 165 mm



Art. 753/5
 Ø 16 mm
 H 275 mm
 L 130 mm

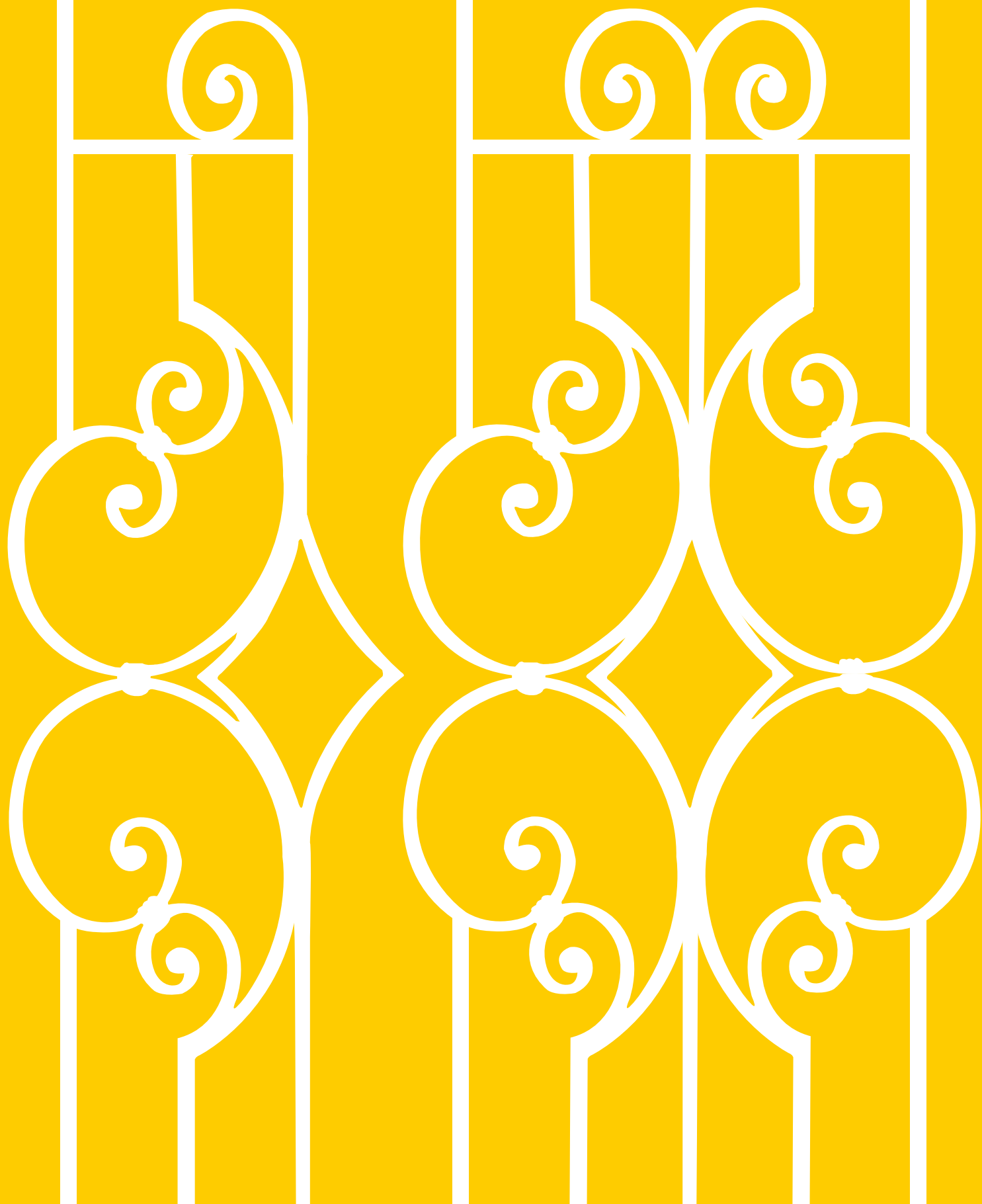

PANNELLI - PANELS

COMPENDIUM 2011

Art. GD219/1
Art. GD219/2



∅ 12 x 6 mm
H 870 mm - L 350 mm

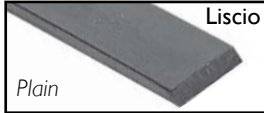

Art. 52/1

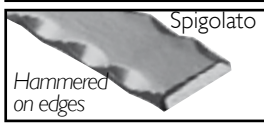

Art. 1671/4

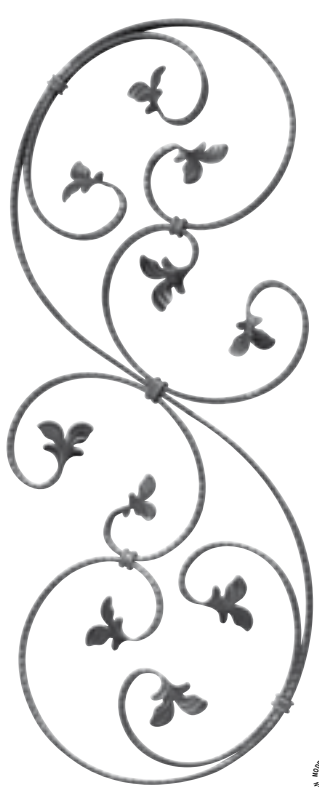

∅ 12 x 6 mm
H 870 mm - L 350 mm

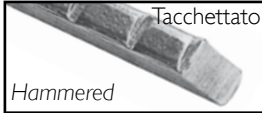

Art. 1671/3

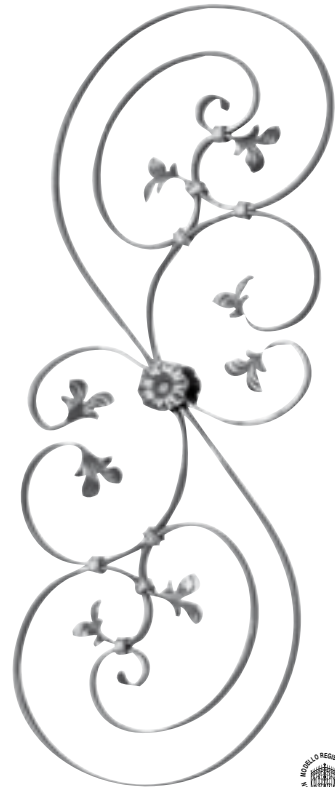

∅ 12 x 6 mm
H 1000 mm - L 360 mm

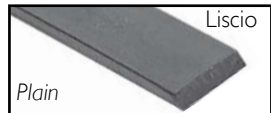

Art. 1670/1

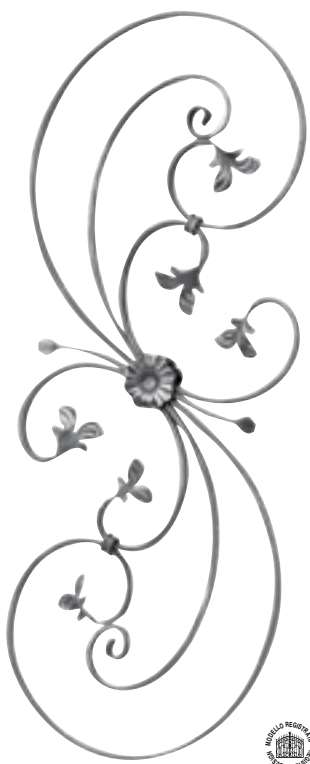

∅ 12 x 6 mm
H 870 mm - L 350 mm

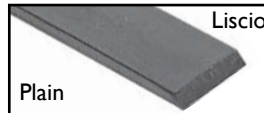

Art. 1670/2



∅ 12 x 6 mm
H 435 mm - L 195 mm

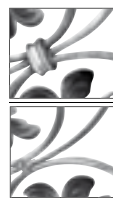
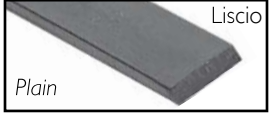

con fascetta with collar

Art. 1671/6

senza fascetta without collar

Art. 1671/5



ARTEFERRO



H 900 mm - L 370 mm



Ø 12 x 12 mm

Art. 541/1

H 900 mm - L 340 mm

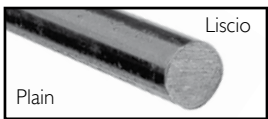

Ø 14 mm

Art. 541/2



H 900 mm - L 350 mm



Ø 12 x 12 mm

Art. 1671/1

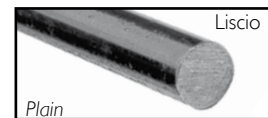

Ø 12 mm

Art. 1671/2

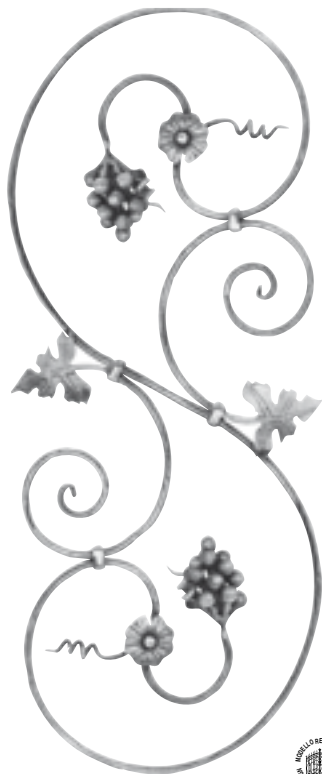

Ø 10 mm

H 900 mm - L 370 mm

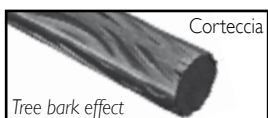

Art. 485/1



Ø 16 x 8 mm

H 870 mm - L 370 mm

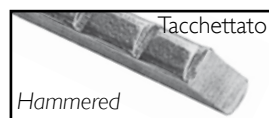

Art. 52/G/1



H 640 mm
L 265 mm

● Art. 1050/4
Ø 12 mm



H 720 mm
L 265 mm

● Art. 1050/3
Φ 14 x 14 mm



H 720 mm
L 250 mm

● Art. 540/2
Ø 12 mm



H 720 mm
L 235 mm

● Art. 62/1
Ø 20 x 6 mm

● Art. 1050/1
Ø 20 x 6 mm

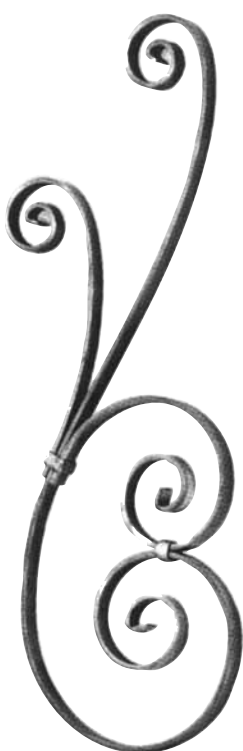

H 720 mm
L 235 mm

● Art. 63/1
Ø 20 x 4 mm

● Art. 63/2
Ø 20 x 6 mm



H 720 mm
L 235 mm

● Art. 62/2
Ø 20 x 6 mm

H 720 mm
L 245 mm

● Art. 1050/2
Φ 10 x 10 mm



H 820 mm
L 235 mm

● Art. 63/3
Ø 20 x 4 mm

● Art. 63/4
Ø 20 x 6 mm

● Riccioli terminali fucinati a caldo
End scrolls are hot forged



ARTEFERRO

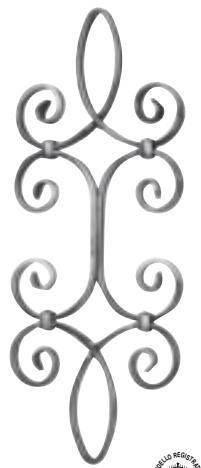
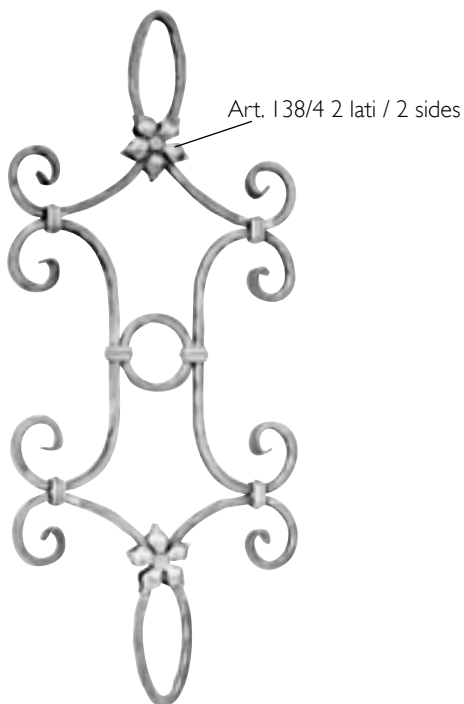

Art. 1647/2
 ∅ 12 x 6 mm
 H 500 mm
 L 200 mm

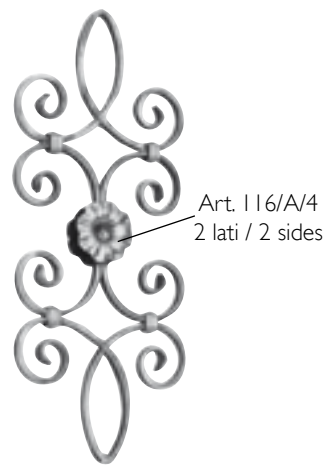

Art. 1647/3
 ∅ 12 x 6 mm
 H 500 mm
 L 200 mm

Art. 479/2
 ∅ 12 x 12 mm
 H 900 mm
 L 385 mm



Art. 1051/5
 ∅ 12 x 6 mm
 H 600 mm
 L 185 mm



Art. 1051/4
 ∅ 12 x 6 mm
 H 400 mm
 L 150 mm



Art. 464/1
 ⌘ 12 x 12 mm
 H 900 mm
 L 230 mm



Art. 464/2
 ⌘ 12 x 12 mm
 H 900 mm
 L 230 mm



Art. 463/1
 ▧ 12 x 6 mm
 H 790 mm
 L 210 mm



Art. 463/2
 ▧ 12 x 6 mm
 H 660 mm
 L 230 mm



Art. 464/3
 ⌘ 12 x 12 mm
 H 900 mm
 L 230 mm



Art. 464/4
 ⌘ 12 x 12 mm
 H 900 mm
 L 230 mm



Art. 463/3
 ▧ 12 x 6 mm
 H 790 mm
 L 210 mm



Art. 463/4
 ▧ 12 x 6 mm
 H 660 mm
 L 210 mm



ARTEFERRO



ARTEFERRO

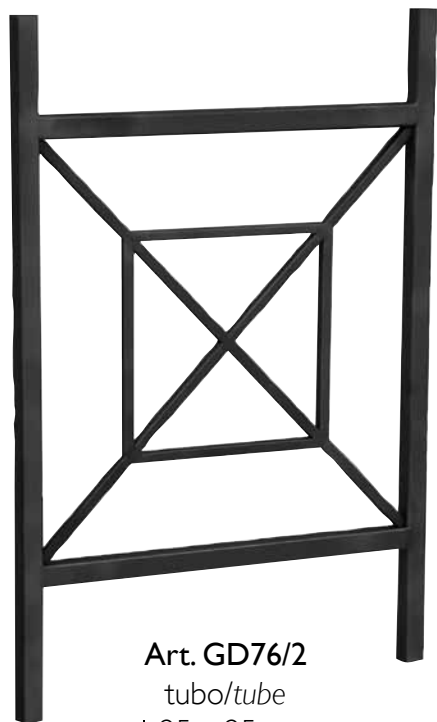

Art. GD76/2
tubo/tube
Ø 25 x 25 mm
H 700 mm
L 500 mm

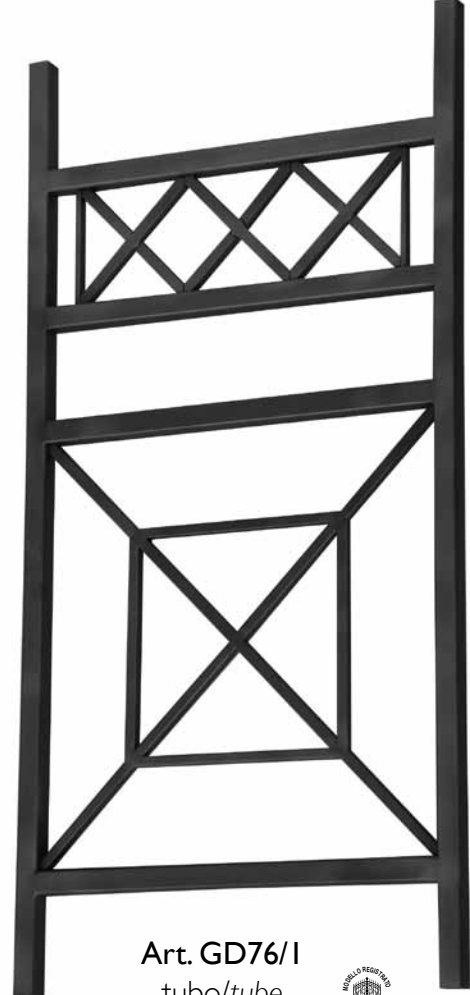

Art. GD76/1
tubo/tube
Ø 25 x 25 mm
H 1000 mm
L 500 mm



ARTEFERRO



Art. GD215/1
Ø 12 mm
H 1000 mm
L 250 mm

Ricci - Scrolls 14 x 8 mm

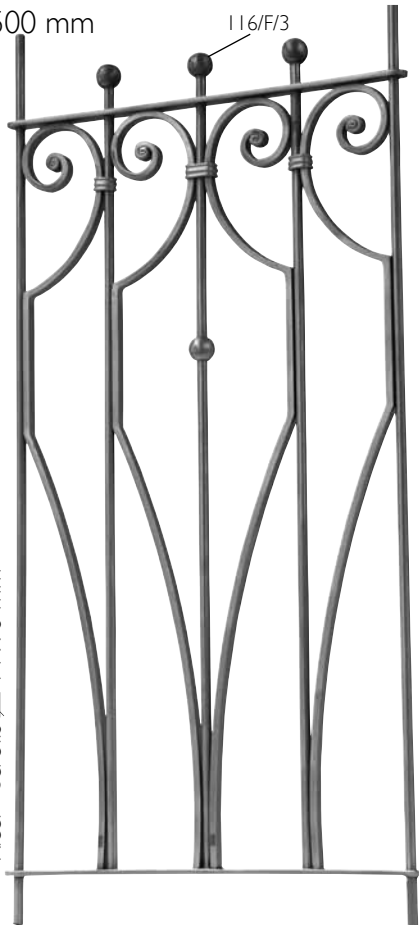

Art. GD215/3
Ø 12 mm
H 1000 mm
L 480 mm

116/F/3

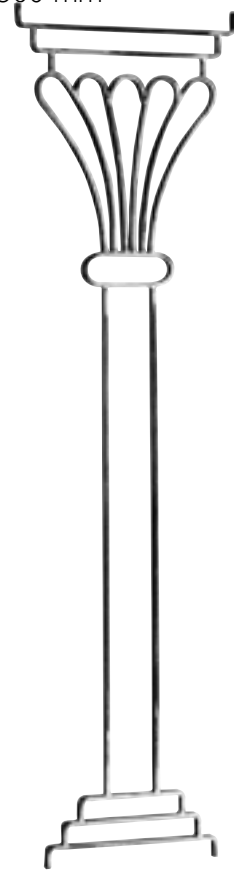

Art. 1120/1
12 x 6 mm
H 1000 mm
L 270 mm



Rosette | 16/A/4 sui due lati - Rosettes | 16/A/4 on both sides



Art. 1680/2
 □ 14 x 8 mm
 H 1000 mm
 L 190 mm

Rosette | 16/A/4 sui due lati - Rosettes | 16/A/4 on both sides

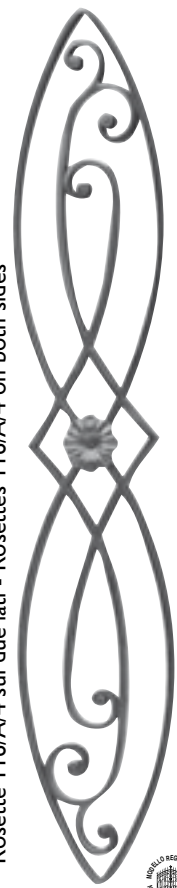

Art. 1681/1
 □ 14 x 8 mm
 H 1000 mm
 L 190 mm

Rosette | 16/A/4 sui due lati - Rosettes | 16/A/4 on both sides



Art. GDI6/2
 □ 14 x 8 mm
 H 1000 mm
 L 160 mm

Rosette | 16/A/4 sui due lati - Rosettes | 16/A/4 on both sides

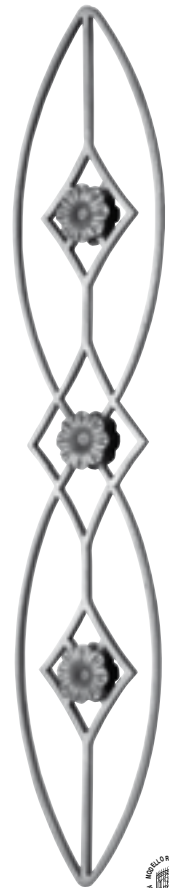

Art. GD15/1
 □ 14 x 8 mm
 H 1000 mm
 L 190 mm

Rosette | 16/A/4 sui due lati - Rosettes | 16/A/4 on both sides



Art. GD15/2
 □ 14 x 8 mm
 H 1000 mm
 L 190 mm



Art. GD15/3
 □ 14 x 8 mm
 H 1000 mm
 L 95 mm

Rosette | 16/A/4 sui due lati - Rosettes | 16/A/4 on both sides



Art. GD16/1
 □ 14 x 8 mm
 H 1000 mm
 L 160 mm



Art. GD17/1
 □ 14 x 8 mm
 H 1000 mm
 L 65 mm



ARTEFERRO



ARTEFERRO

Sinistro - Left

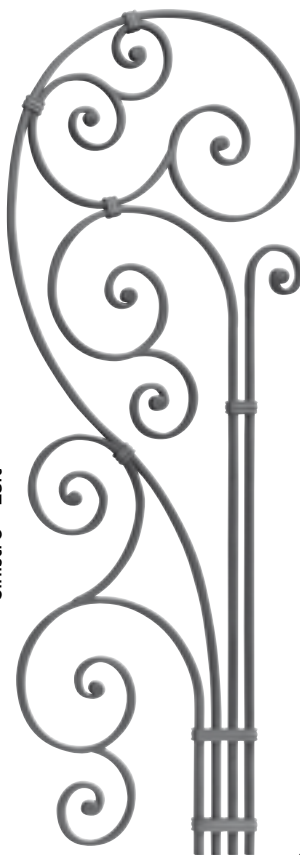

Art. GD164/1
 □ 14 x 8 mm
 H 1000 mm
 L 380 mm



Destro - Right

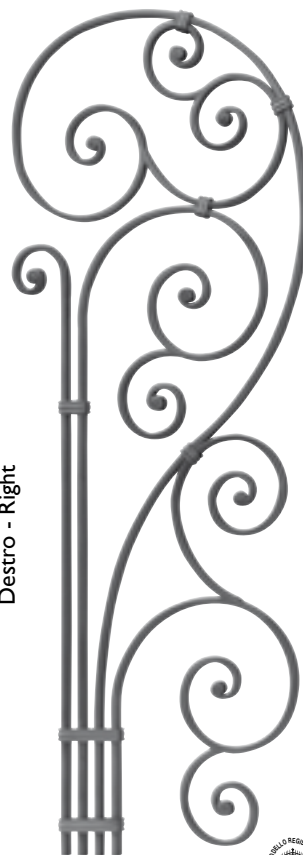

Art. GD164/2
 □ 14 x 8 mm
 H 1000 mm
 L 380 mm



Art. GD223/1
 □ 14 x 8 mm
 H 1000 mm
 L 275 mm



Art. GD222/1
 □ 14 x 8 mm
 H 1000 mm
 L 500 mm



Art. GD222/2
 □ 14 x 8 mm
 H 1000 mm
 L 500 mm



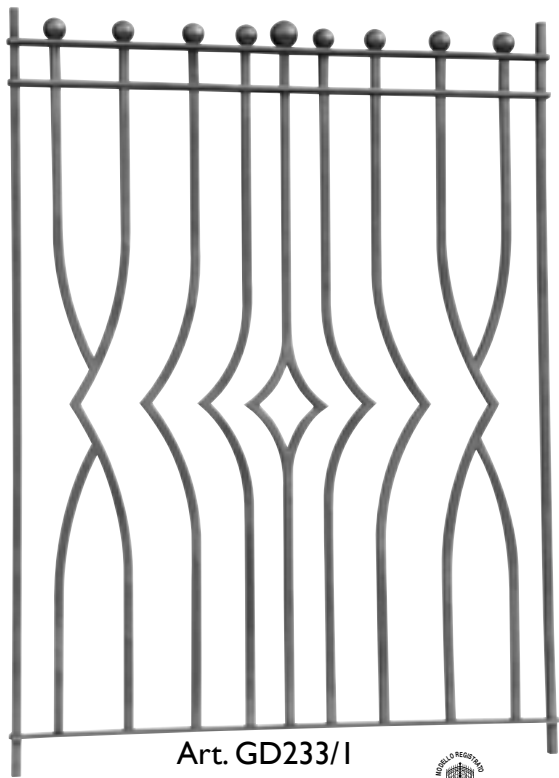

Art. GD233/I
 Φ 12 x 12 mm
 H 1000 mm - L 740 mm

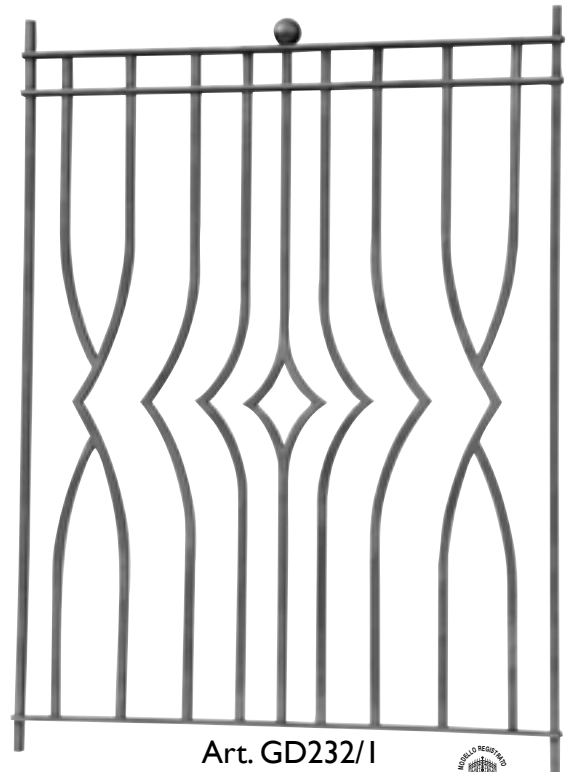

Art. GD232/I
 Φ 12 x 12 mm
 H 1000 mm - L 740 mm



ARTEFERRO

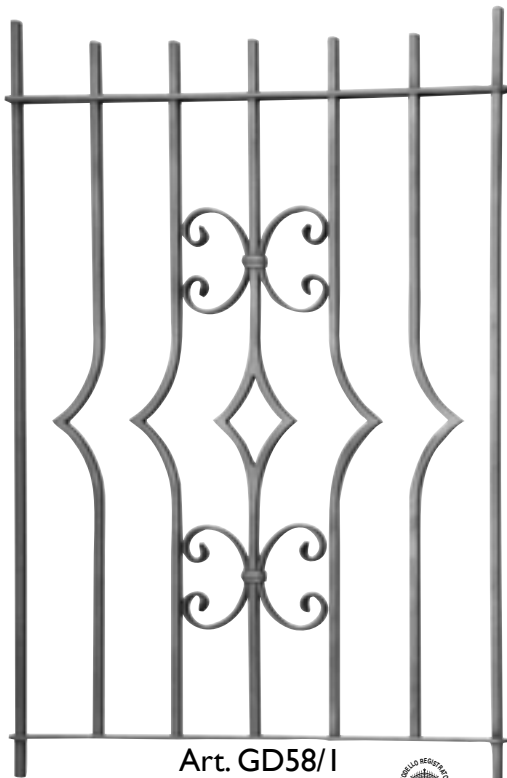

Art. GD58/I
 Φ 12 x 12 mm
 H 1000 mm - L 685 mm

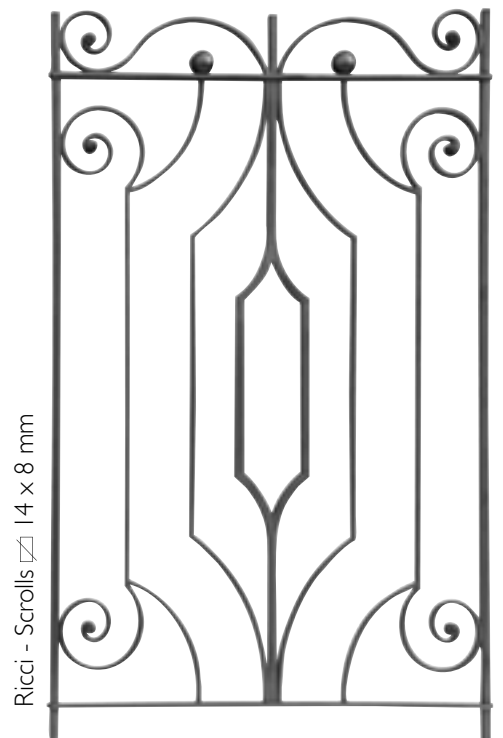

Ricci - Scrolls \square 14 x 8 mm

Art. GD242/I
 Φ 12 x 12 mm
 H 1000 mm - L 640 mm



Rosette 116/A/4 sui due lati - Rosettes 116/A/4 on both sides

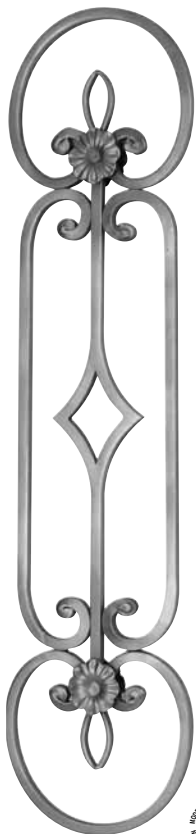

Rosette 116/A/4 sui due lati - Rosettes 116/A/4 on both sides

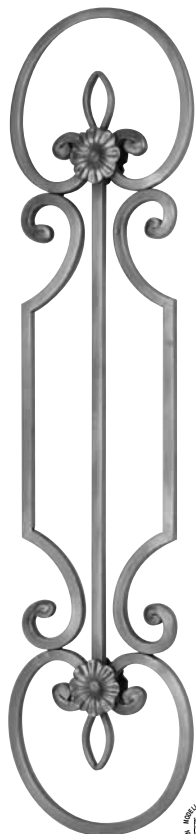

Art. GD31/1

Φ 14 x 14 mm

H 1000 mm

L 245 mm

Art. GD31/2

Φ 14 x 14 mm

H 1000 mm

L 245 mm



Art. GD69/1

Φ 12 x 12 mm

H 1000 mm

L 210 mm

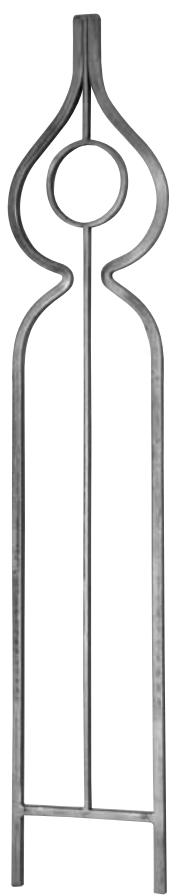

Art. GD69/2

Φ 12 x 12 mm

H 1000 mm

L 210 mm



PANNELLI - PANELS

ARTEFERRO



Art. 1045/7
 Ø 12 x 12 mm
 H 770 mm
 L 250 mm

Art. 1045/8
 Ø 12 x 12 mm
 H 770 mm
 L 250 mm

Art. 1045/5
 Ø 12 x 12 mm
 H 770 mm
 L 250 mm

Art. 1045/6
 Ø 12 x 12 mm
 H 770 mm
 L 250 mm





Art. GD253/2
 Ø 12 mm
 H 500 mm
 L 150 mm

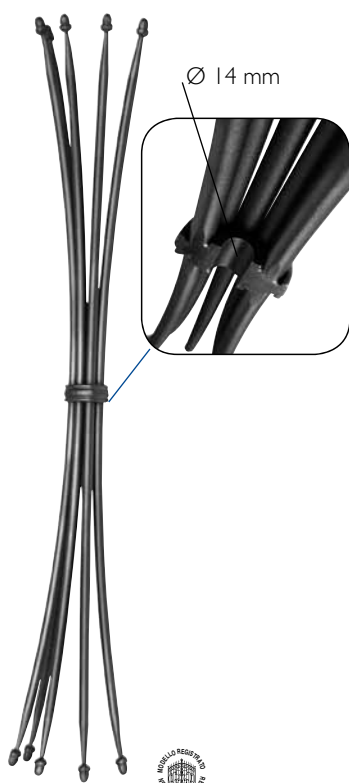

Art. GD253/1
 Ø 12 mm
 H 870 mm
 L 150 mm

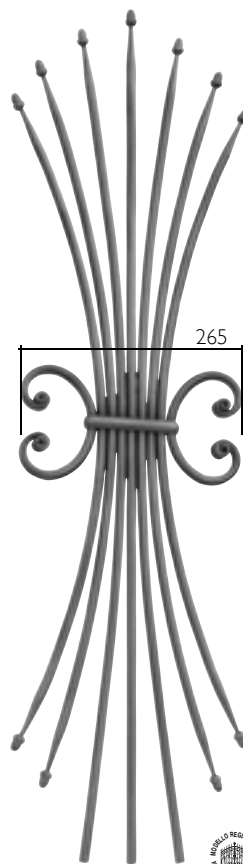

Art. GD255/1
 Ø 12 mm
 H 1000 mm
 L 290 mm



Art. GD255/2
 Ø 12 mm
 H 1000 mm
 L 150 mm



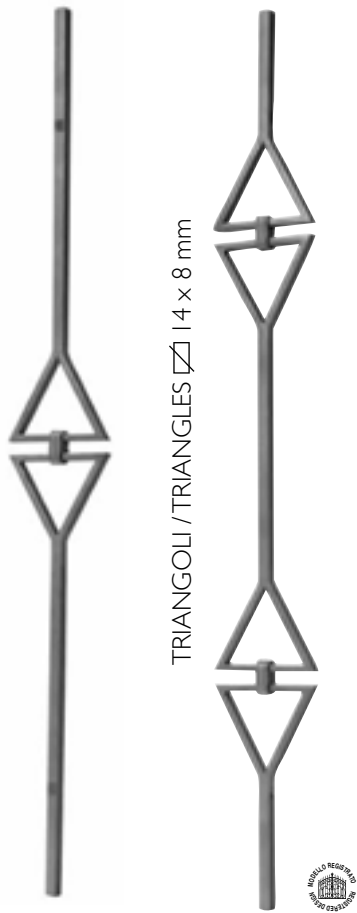

TRIANGOLI / TRIANGLES \square 14 x 8 mm

Art. GDI81/1
 Φ 14 x 14 mm
 H 1000 mm
 L 130 mm

Art. GDI81/2
 Φ 14 x 14 mm
 H 1000 mm
 L 130 mm

QUADRATI / SQUARES \square 14 x 8 mm



Art. GDI82/1
 Φ 14 x 14 mm
 H 1000 mm
 L 115 mm

QUADRATI / SQUARES \square 14 x 8 mm



Art. GDI82/2
 Φ 14 x 14 mm
 H 1000 mm
 L 115 mm

QUADRATI / SQUARES \square 14 x 8 mm

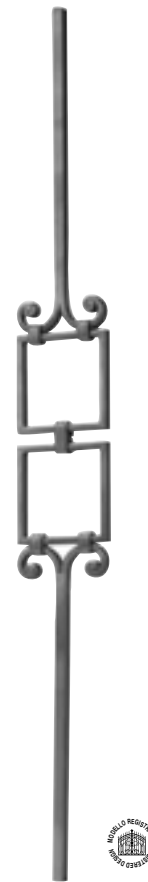

Art. GDI84/1
 Φ 14 x 14 mm
 H 1000 mm
 L 115 mm

QUADRATI / SQUARES \square 14 x 8 mm



Art. GDI84/2
 Φ 14 x 14 mm
 H 1000 mm
 L 115 mm

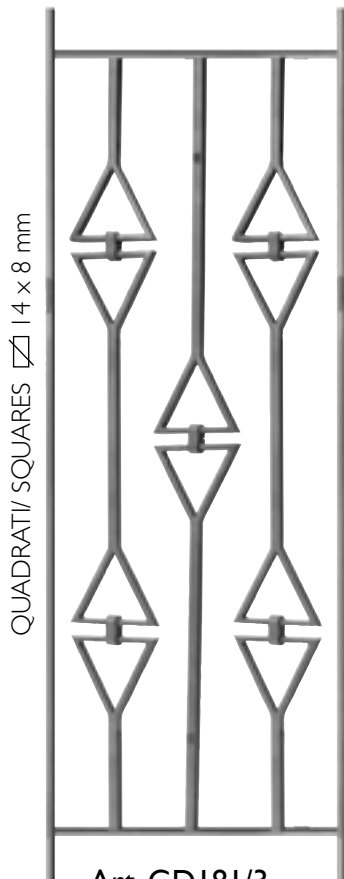

QUADRATI / SQUARES \square 14 x 8 mm

Art. GDI81/3
 \square 14 x 8 mm
 H 1000 mm
 L 400 mm

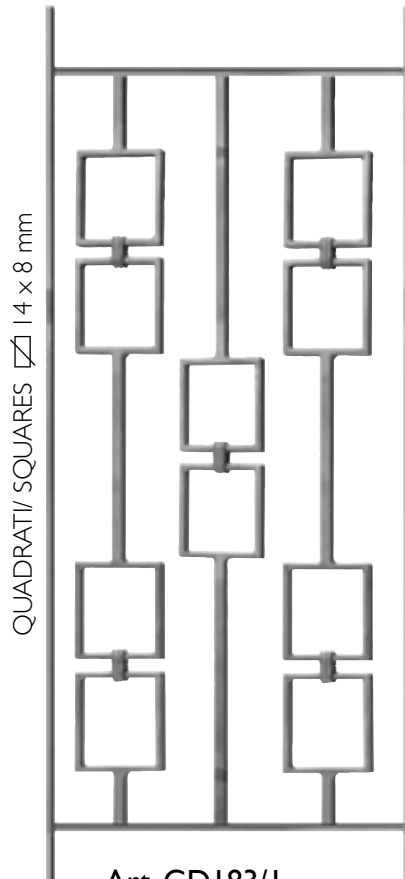

QUADRATI / SQUARES \square 14 x 8 mm

Art. GDI83/1
 \square 14 x 8 mm
 H 1000 mm
 L 400 mm



ARTEFERRO

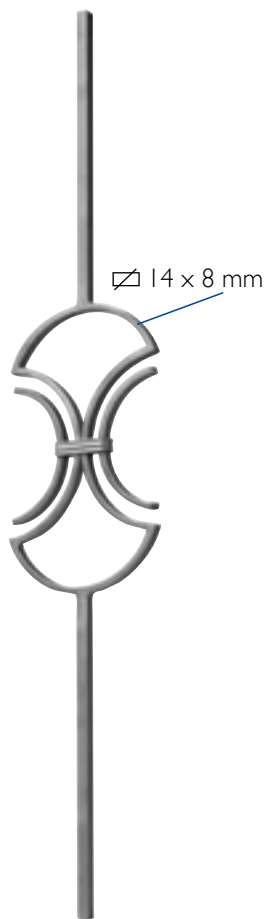

Art. GDI87/1
 Φ 14 x 14 mm
 H 1000 mm
 L 190 mm



Art. GDI89/1
 Φ 14 x 8 mm
 H 975 mm
 L 190 mm

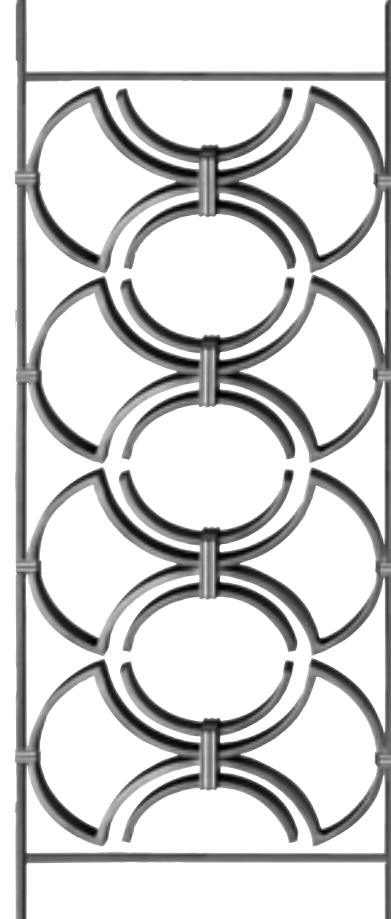

Art. GDI89/2
 Φ 14 x 8 mm
 H 1000 mm
 L 340 mm



Art. GDI86/1
 Φ 14 x 14 mm
 H 1000 mm
 L 170 mm

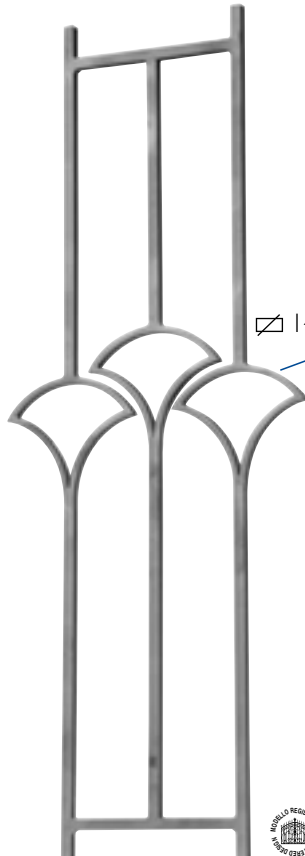

Art. GDI86/3
 Φ 14 x 14 mm
 H 1000 mm
 L 390 mm

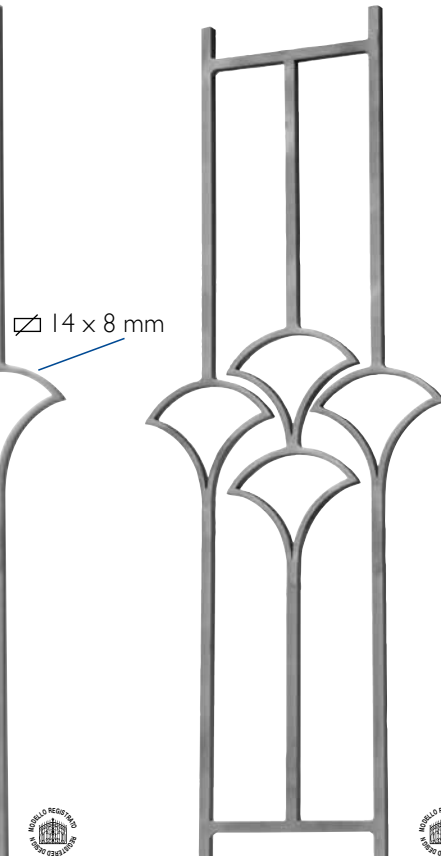

Art. GDI86/2
 Φ 14 x 14 mm
 H 1000 mm
 L 390 mm



Art. GD38/1
 Ø 12 mm
 H 1000 mm
 L 230 mm



Art. GD38/2
 Ø 12 mm
 H 1000 mm
 L 65 mm



Art. GD26/1
 Φ 12 x 12 mm
 H 1000 mm
 L 235 mm



Art. GD66/1
 Φ 12 x 12 mm
 H 1000 mm
 L 125 mm



Art. GD47/2
 Ø 12 mm
 H 1000 mm
 L 125 mm

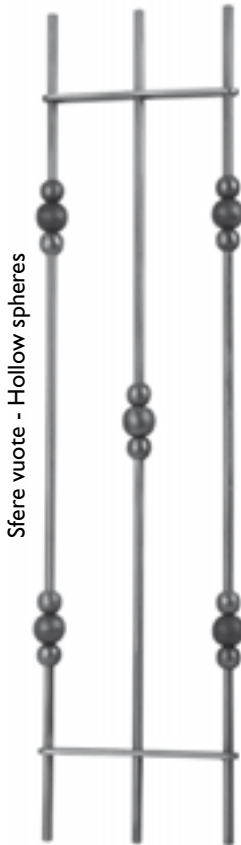

Sfere vuote - Hollow spheres



Art. GD50/1
 Ø 12 mm
 H 1000 mm
 L 240 mm



Art. GD66/3
 Φ 12 x 12 mm
 H 1000 mm
 L 235 mm

Art. GD67/1
 Φ 12 x 12 mm
 H 1000 mm
 L 125 mm



ARTEFERRO

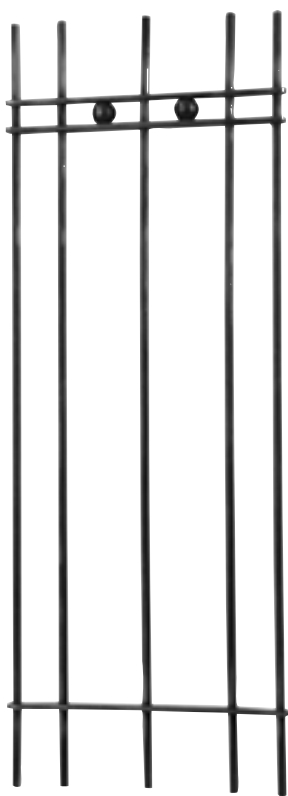

Art. GD47/3
 Ø 12 mm
 H 1000 mm
 L 360 mm

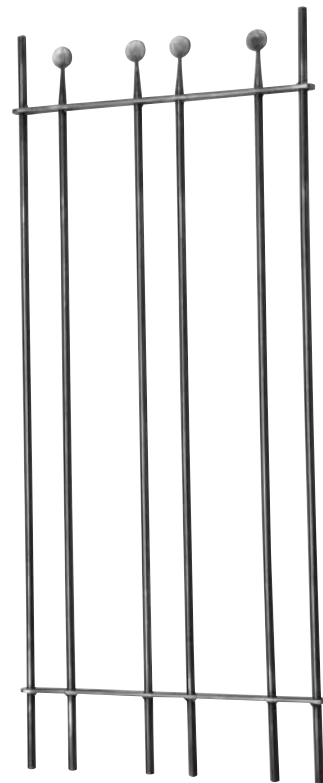

Art. GD47/1
 Ø 12 mm
 H 1000 mm
 L 420 mm

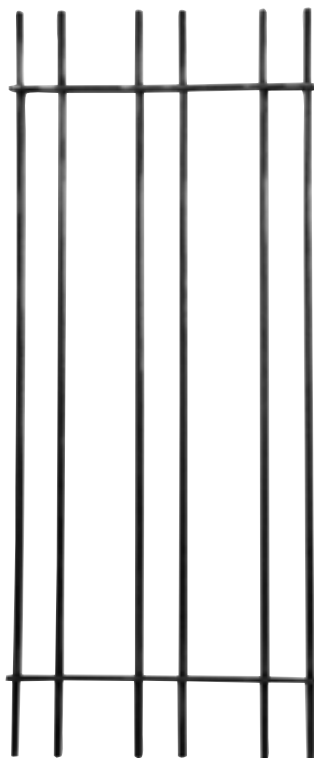

Art. GD47/4
 Ø 12 mm
 H 1000 mm
 L 420 mm

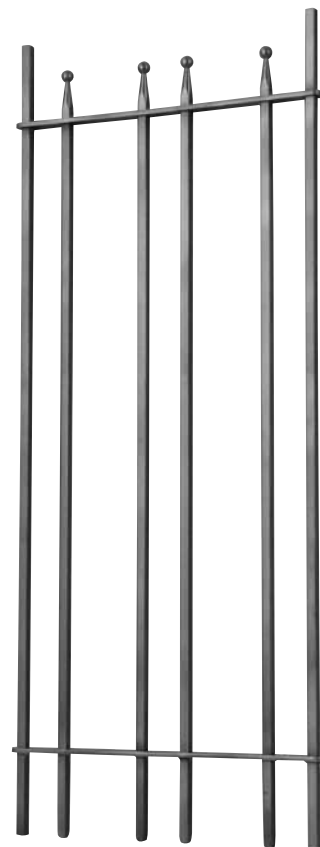

Art. GD66/2
 Ø 12 x 12 mm
 H 1000 mm
 L 425 mm



ARTEFERRO

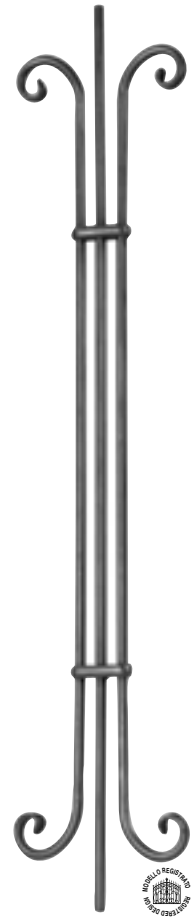

Art. GD45/2
 Ø 12 mm
 H 1000 mm
 L 200 mm

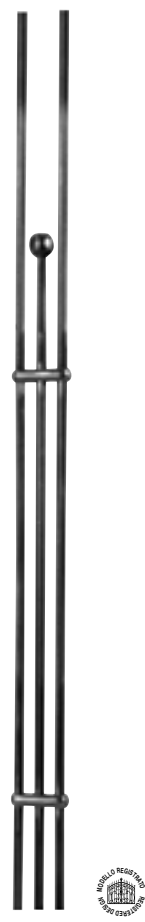

Art. GD39/2
 Ø 12 mm
 H 1000 mm
 L 60 mm



Art. GD39/1
 Ø 12 mm
 H 1000 mm
 L 200 mm



Art. GD39/3
 Ø 12 mm
 H 1000 mm
 L 190 mm



Art. GD41/2
 Ø 12 mm
 H 1000 mm
 L 130 mm



Art. GD42/2
 Ø 12 mm
 H 1000 mm
 L 115 mm

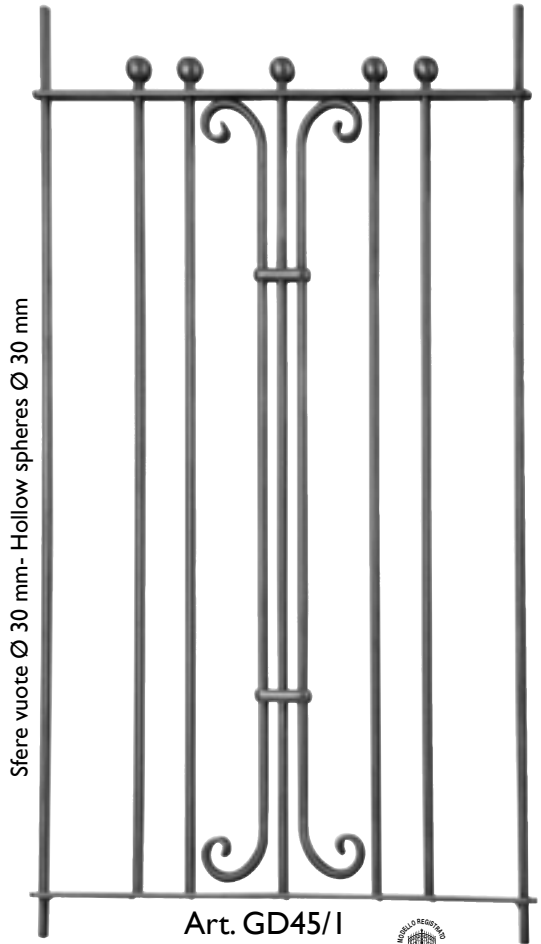

Sfere vuote Ø 30 mm- Hollow spheres Ø 30 mm

Art. GD45/1
 Ø 12 mm
 H 1000 mm - L 610 mm



ARTEFERRO



Art. GDI61/3
 □ 14 x 8 mm
 H 1000 mm
 L 80 mm



Art. GDI61/2
 □ 14 x 8 mm
 H 1000 mm
 L 85 mm

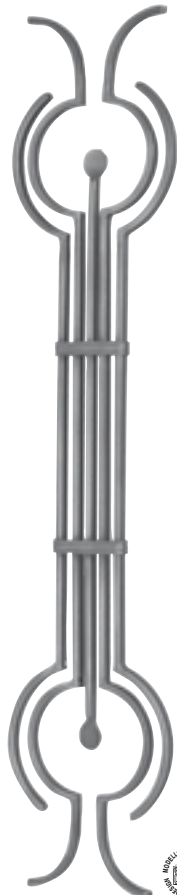

Art. GDI61/1
 □ 14 x 8 mm
 H 1000 mm
 L 200 mm



Art. GDI66/2
 □ 14 x 8 mm
 H 1000 mm
 L 200 mm

art. 116/A/4 su 2 lati on 2 sides



Art. GD61/1
 □ 12 x 12 mm
 H 1000 mm
 L 430 mm



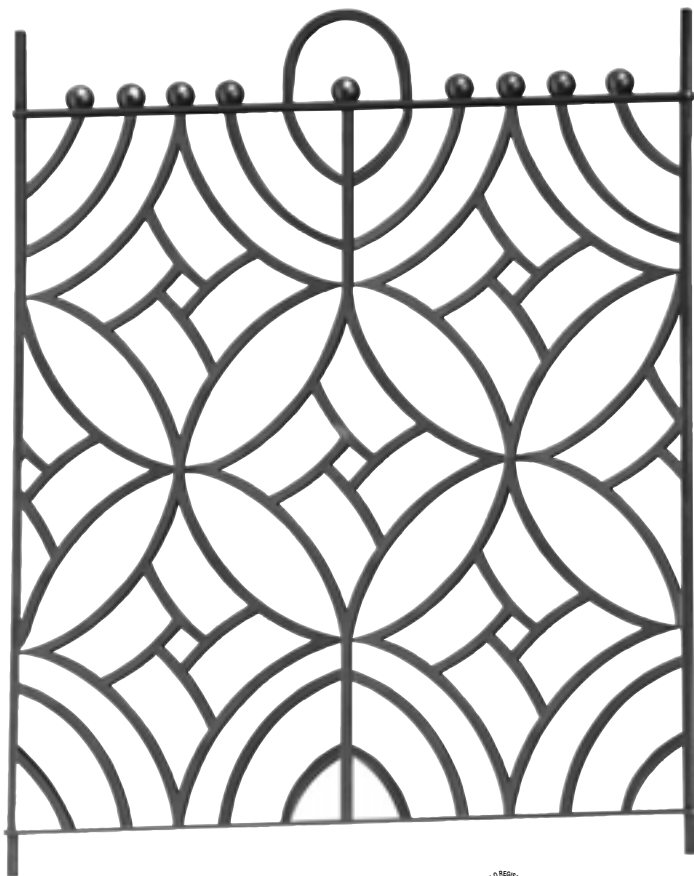

Art. GD211/1
 Ø 12 x 12 mm
 H 1000 mm
 L 830 mm

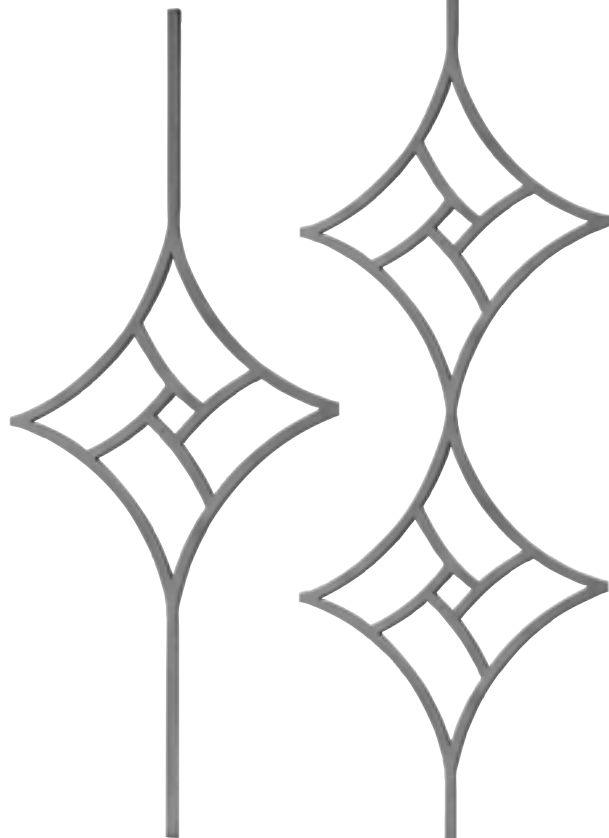

Art. GD211/3
 Ø 12 x 12 mm
 H 1000 mm
 L 395 mm



Art. GD211/4
 Ø 12 x 12 mm
 H 1000 mm
 L 395 mm



Art. 116/F/3

Art. GD212/1
 Ø 12 x 12 mm
 H 1000 mm
 L 420 mm

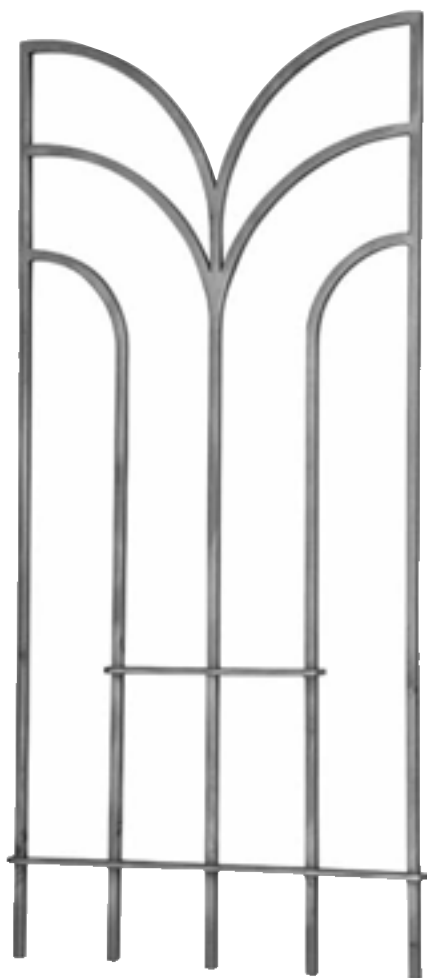

Art. GD68/I
 Φ 12 x 12 mm
 H 1000 mm
 L 460 mm

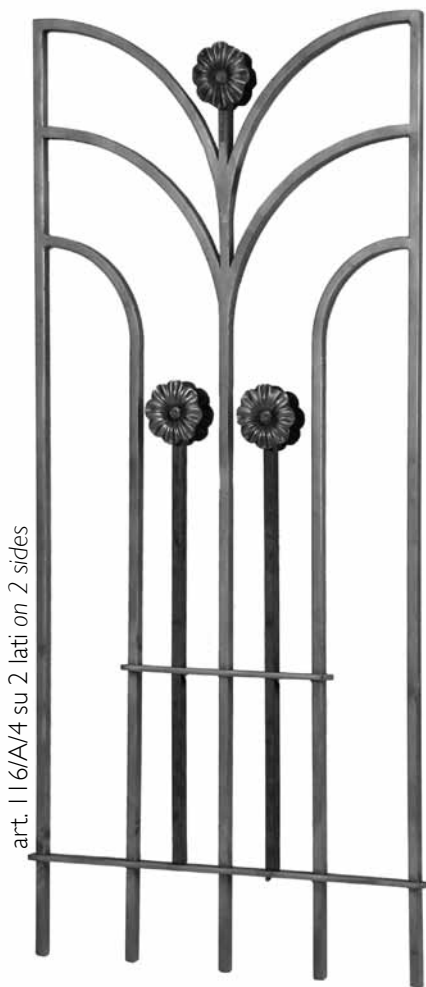

art. 116/A/4 su 2 lati on 2 sides

Art. GD71/I
 Φ 12 x 12 mm
 H 1000 mm
 L 460 mm



Art. 157/I

Art. GD70/I
 Φ 12 x 12 mm
 H 1000 mm
 L 460 mm

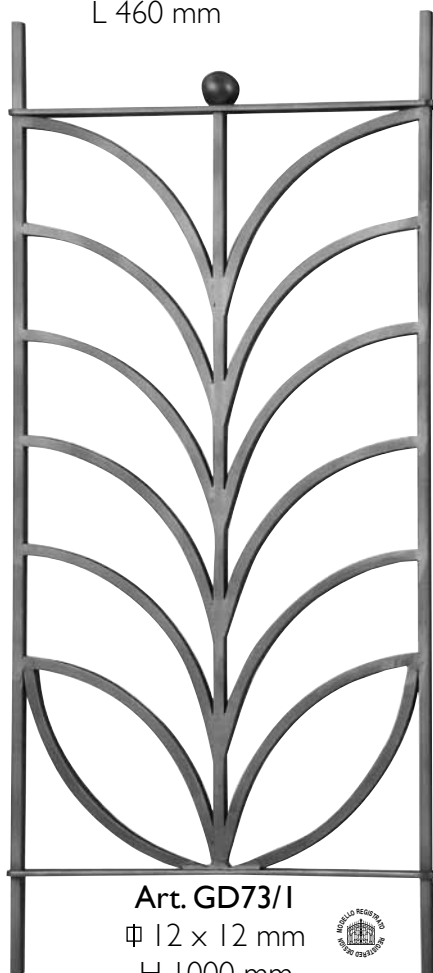

Art. GD73/I
 Φ 12 x 12 mm
 H 1000 mm
 L 455 mm

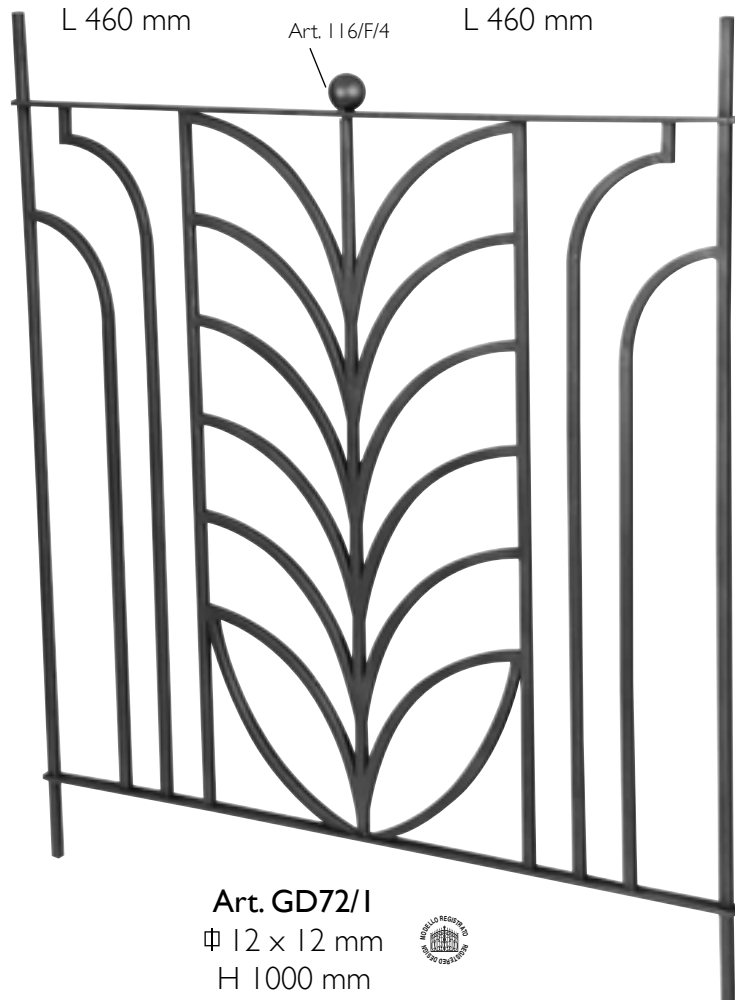

Art. 116/F/4

Art. GD72/I
 Φ 12 x 12 mm
 H 1000 mm
 L 935 mm



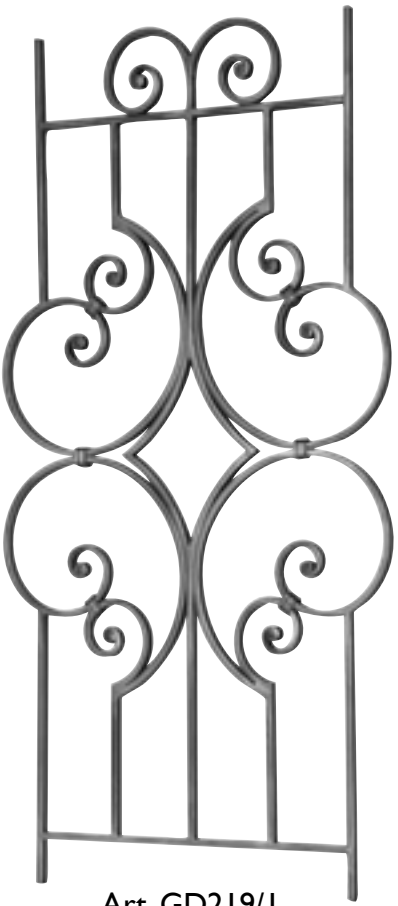

Art. GD219/1
 □ 14 x 8 mm
 H 1000 mm
 L 500 mm

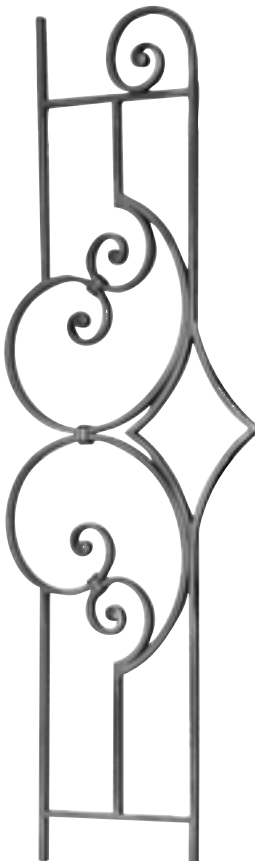

Art. GD219/2
 □ 14 x 8 mm
 H 1000 mm
 L 340 mm

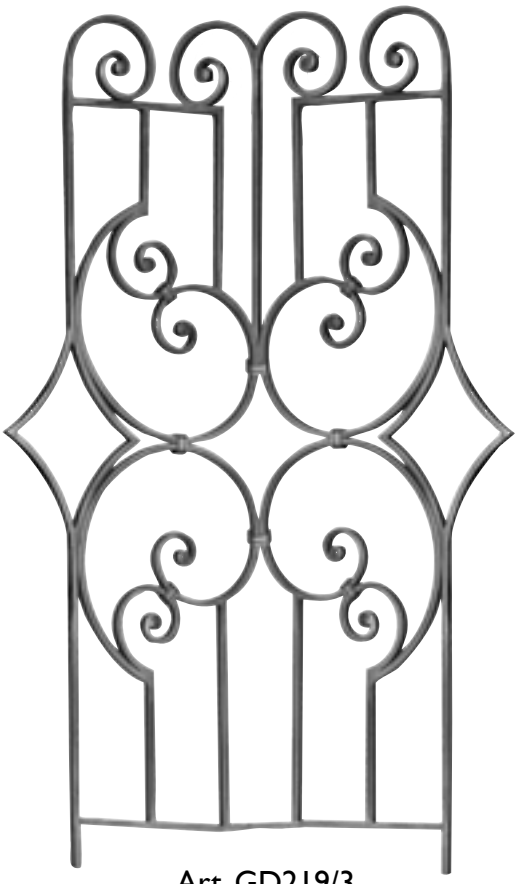

Art. GD219/3
 □ 14 x 8 mm
 H 1000 mm
 L 680 mm



Art. GD241/2
 Ø 12 mm
 H 1000 mm
 L 450 mm



Art. GD241/1
 Ø 12 mm
 H 1000 mm
 L 450 mm



Art. 116/F/3



Art. GD240/1
 □ 14 x 8 mm
 H 1000 mm
 L 200 mm



ARTEFERRO



Art. GD245/1
 □ 14 x 8 mm
 H 1000 mm
 L 330 mm

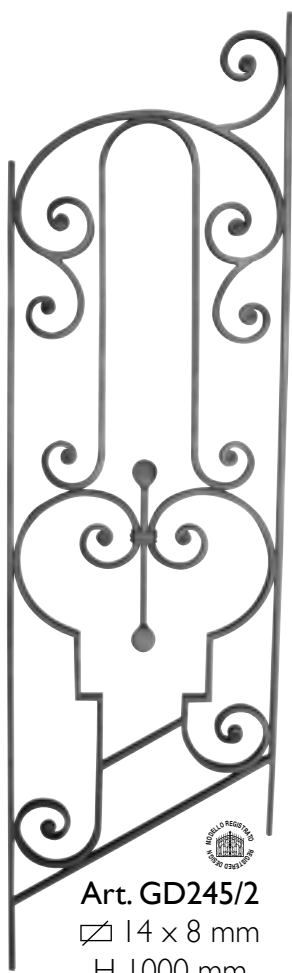

Art. GD245/2
 □ 14 x 8 mm
 H 1000 mm
 L 330 mm

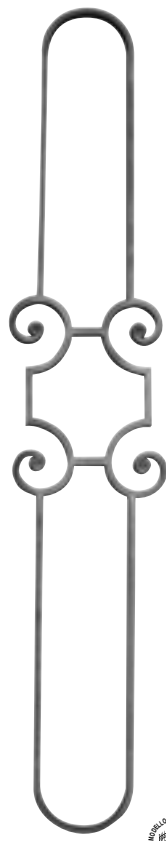

Art. GD245/3
 □ 14 x 8 mm
 H 1000 mm
 L 180 mm



Art. GD159/1
 □ 14 x 8 mm
 H 1000 mm
 L 280 mm

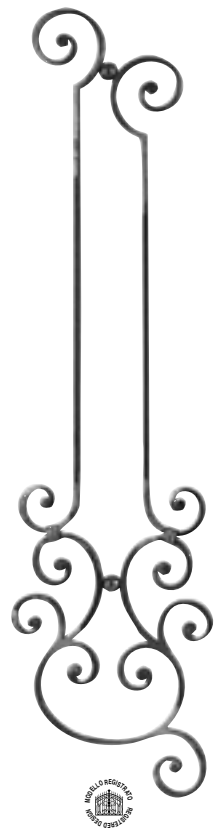

Art. GD159/2
 □ 14 x 8 mm
 H 1000 mm
 L 280 mm



ARTEFERRO



Art. GD169/1
 □ 14 x 8 mm
 H 1000 mm
 L 195 mm



Art. GD169/2
 □ 14 x 8 mm
 H 1000 mm
 L 200 mm



Art. GD78/1
 Ø 12 x 12 mm
 H 1000 mm
 L 125 mm



Art. GD78/2
 Ø 12 x 12 mm
 H 1000 mm
 L 125 mm



Art. GD78/3
 Ø 12 x 12 mm
 H 1000 mm
 L 125 mm



Art. GD88/1
 Ø 12 x 12 mm
 H 1000 mm
 L 125 mm

Art. GD88/2
 Ø 14 x 14 mm
 H 1000 mm
 L 128 mm



ARTEFERRO

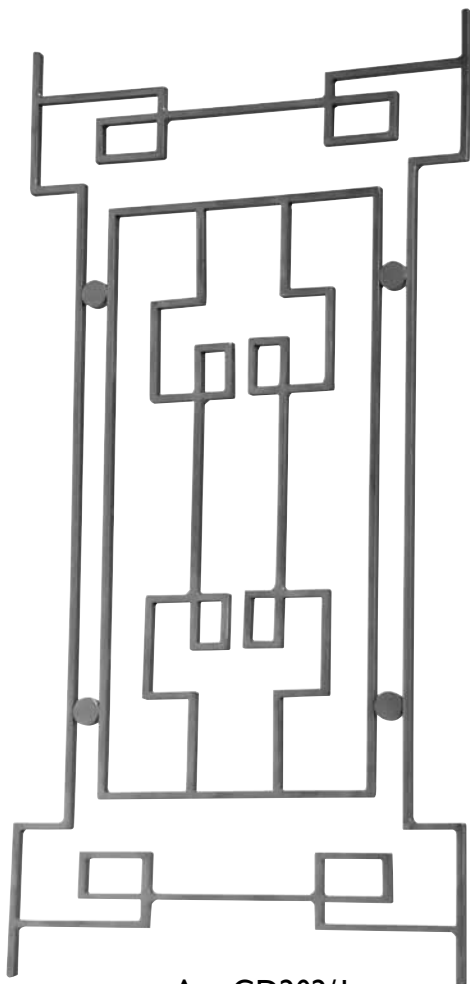

Art. GD202/1

∅ 14 x 8 mm

H 1000 mm

L 500 mm

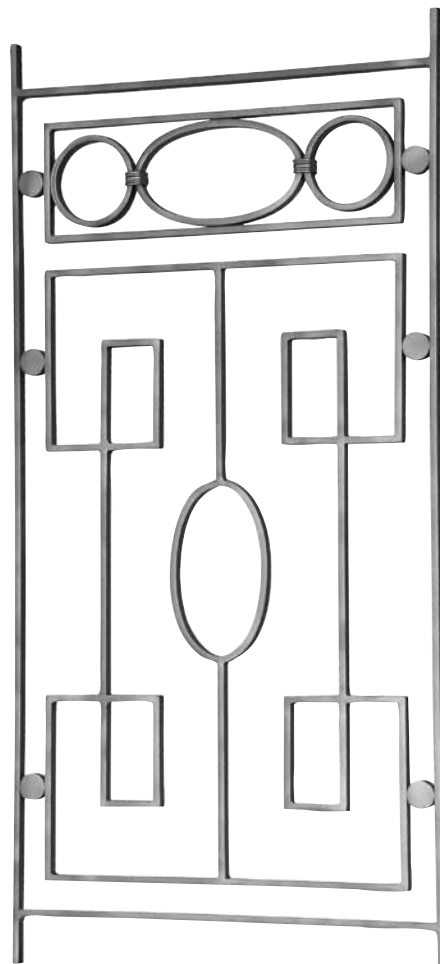

Art. GD205/1

∅ 14 x 8 mm

H 1000 mm

L 495 mm

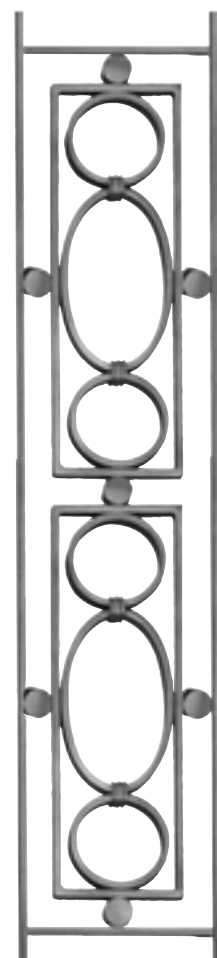

Art. GD205/2

∅ 14 x 8 mm

H 1000 mm

L 210 mm



Art. GD153/2

∅ 14 x 8 mm

H 1000 mm

L 115 mm



Art. GD153/3

∅ 14 x 8 mm

H 1000 mm

L 200 mm



Sfere vuote Ø 30 mm - Hollow spheres Ø 30 mm

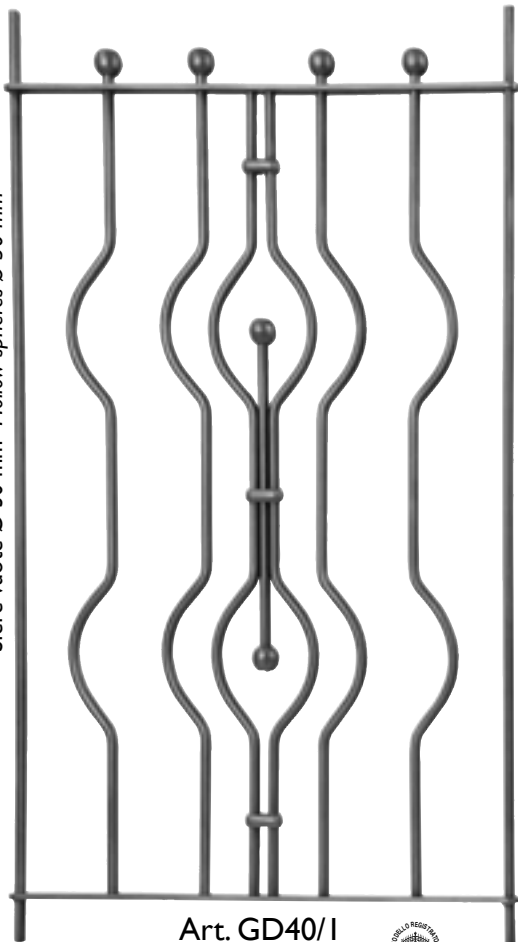

Art. GD40/I
 Ø 12 x 12 mm
 H 1000 mm
 L 620 mm



Sfere vuote Ø 30 mm - Hollow spheres Ø 30 mm

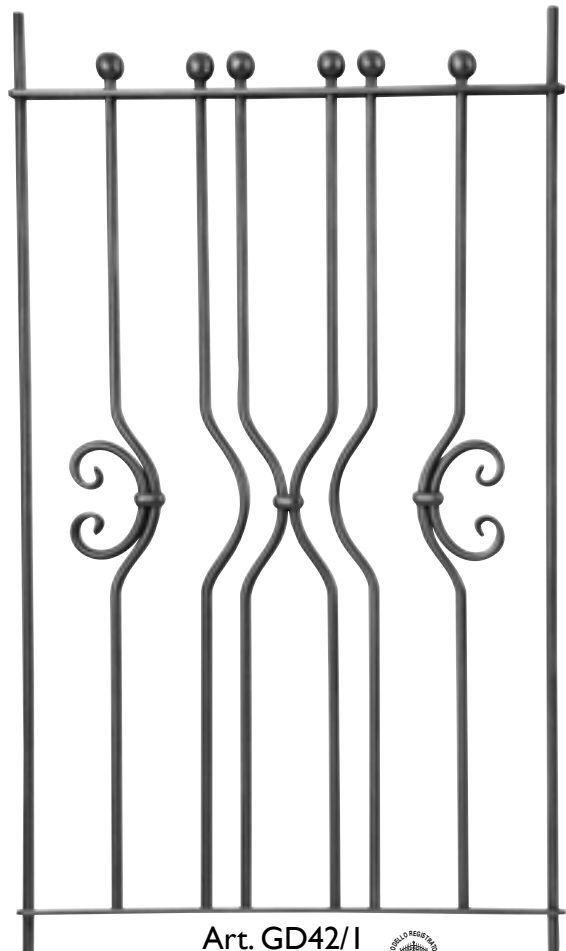

Art. GD42/I
 Ø 12 mm
 H 1000 mm
 L 585 mm

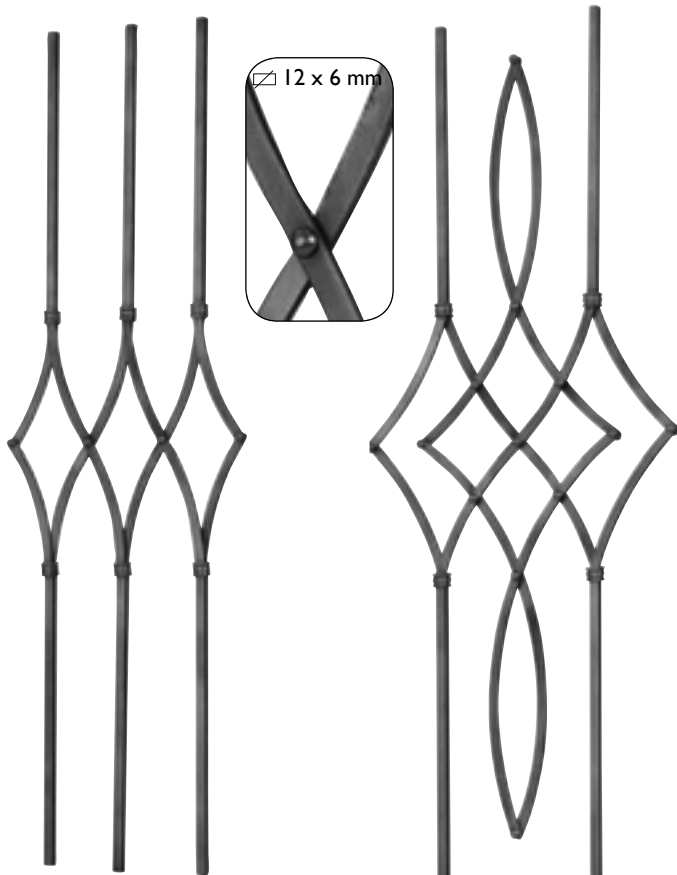

Art. GD21/I
 Ø 12 x 12 mm
 H 1000 mm
 L 315 mm



Art. GD21/2
 Ø 12 x 12 mm
 H 1000 mm
 L 415 mm



ARTEFERRO

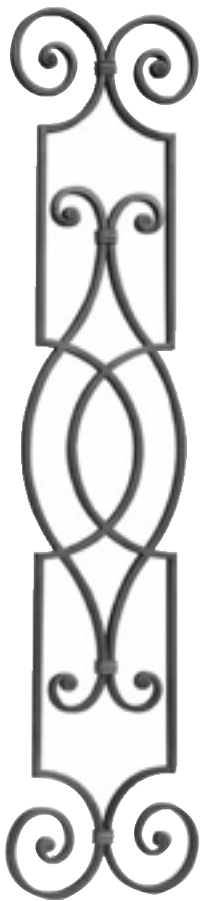

Art. GDI73/1
 □ 14 x 8 mm
 H 1000 mm
 L 230 mm



Art. GDI73/2
 □ 14 x 8 mm
 H 1000 mm
 L 165 mm



Art. GDI73/4
 □ 14 x 8 mm
 H 1000 mm
 L 165 mm

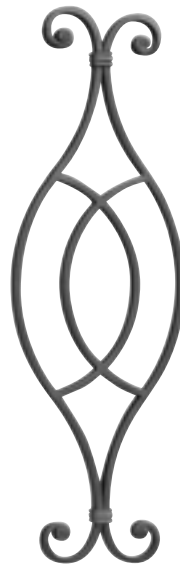

Art. GDI73/3
 □ 14 x 8 mm
 H 600 mm
 L 200 mm



Art. GDI75/7
 □ 14 x 8 mm
 H 1000 mm
 L 200 mm



Art. GD226/3
 □ 14 x 8 mm
 H 1000 mm
 L 535 mm

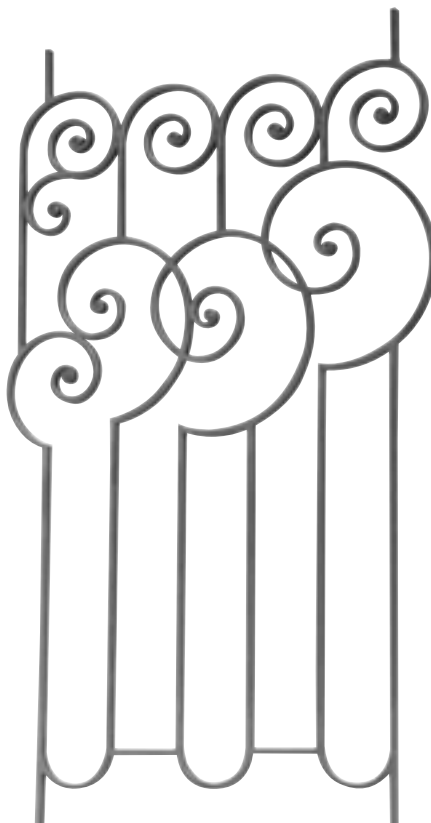

Art. GD228/1
 □ 14 x 8 mm
 H 1000 mm
 L 580 mm

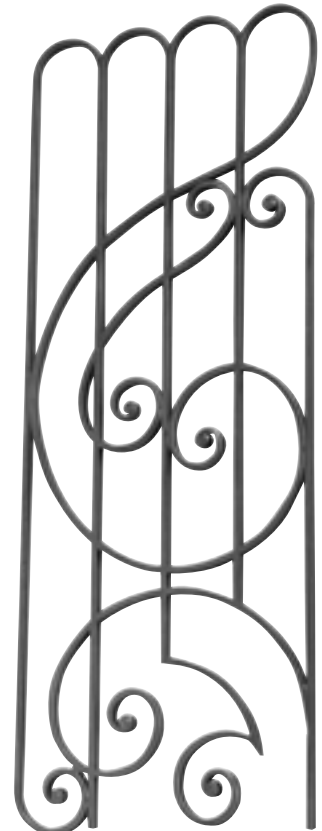

Art. GD225/1
 □ 14 x 8 mm
 H 1000 mm
 L 385 mm



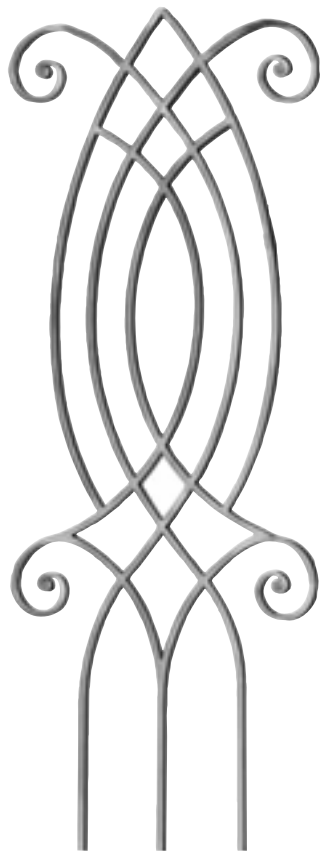

Art. GD234/I
 □ 14 x 8 mm
 H 1000 mm
 L 380 mm

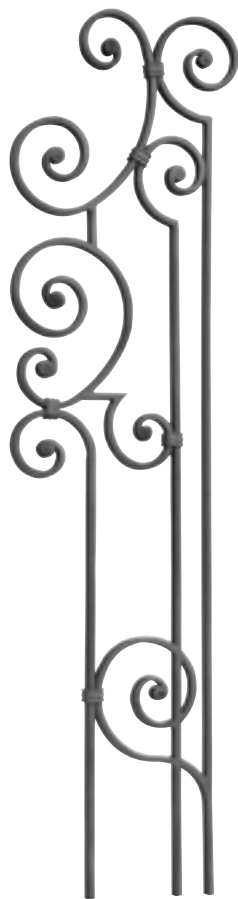

Art. GDI63/2
 □ 14 x 8 mm
 H 1000 mm
 L 280 mm



Art. GDI63/1
 □ 14 x 8 mm
 H 1000 mm
 L 280 mm



ARTEFERRO



Art. GD235/I
 □ 14 x 8 mm
 H 1000 mm
 L 890 mm

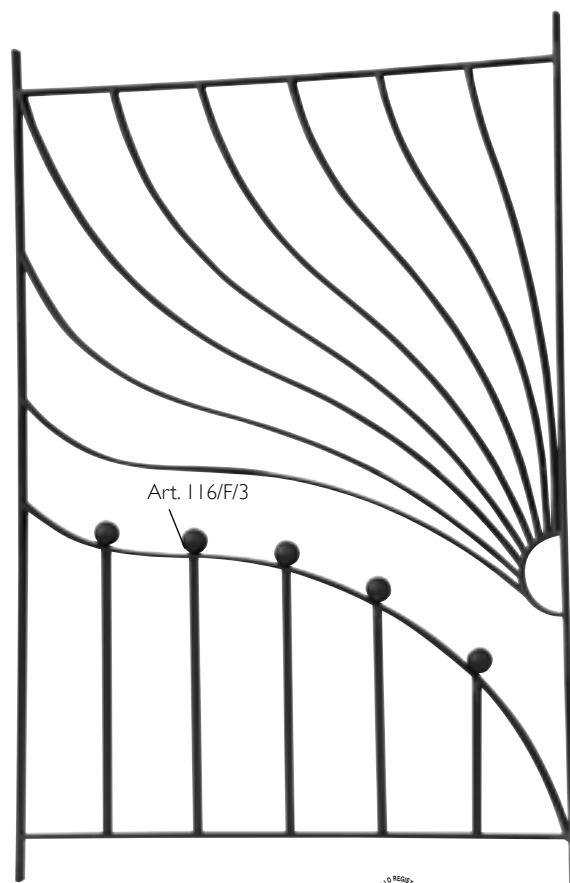

Art. I16/F/3

Art. GD247/I
 □ 20 x 6 mm
 H 1000 mm
 L 670 mm



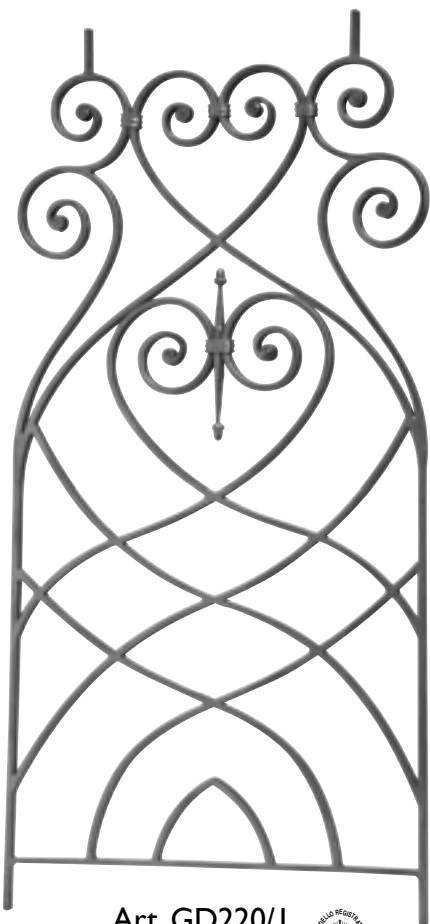

Art. GD220/1
 □ 14 x 8 mm
 H 1000 mm
 L 500 mm

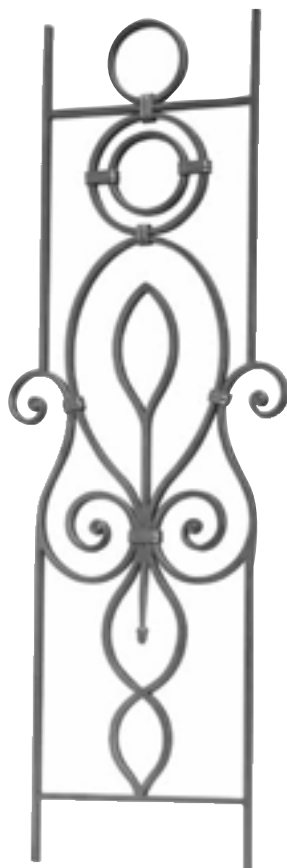

Art. GD177/2
 □ 14 x 8 mm
 H 1000 mm
 L 350 mm



Art. GD166/1
 □ 14 x 8 mm
 H 1000 mm
 L 200 mm



Art. GD177/1
 □ 14 x 8 mm
 H 1000 mm
 L 205 mm

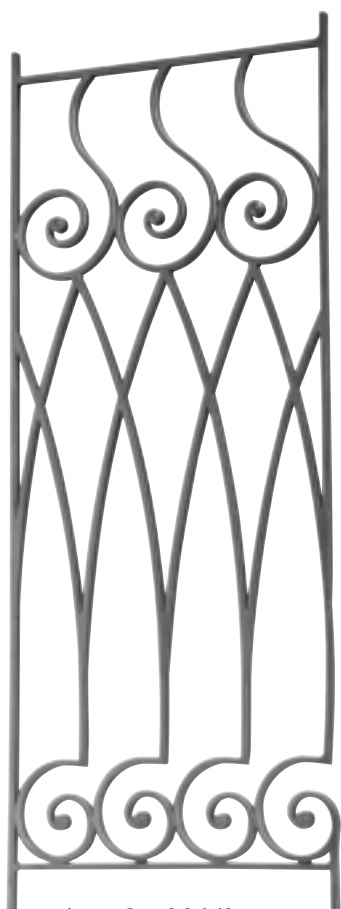

Art. GD220/2
 □ 14 x 8 mm
 H 1000 mm
 L 395 mm



Art. NEW0050 su 2 lati on two sides

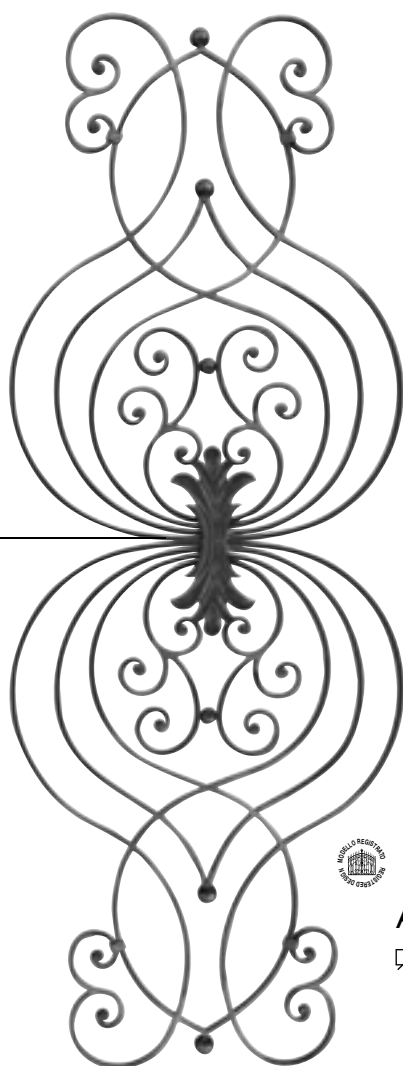

Art. GD231/1
 □ 14 x 8 mm
 H 1600 mm
 L 600 mm

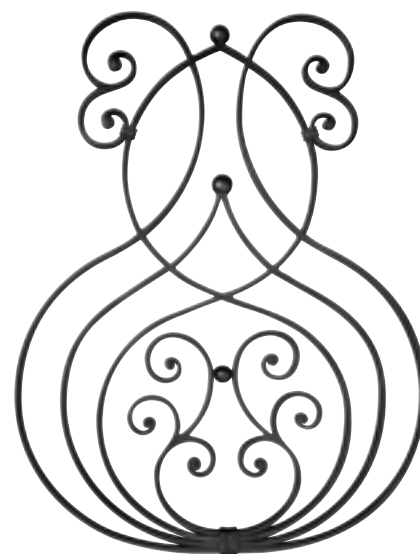

Art. GD231/2
 □ 14 x 8 mm
 H 800 mm
 L 600 mm



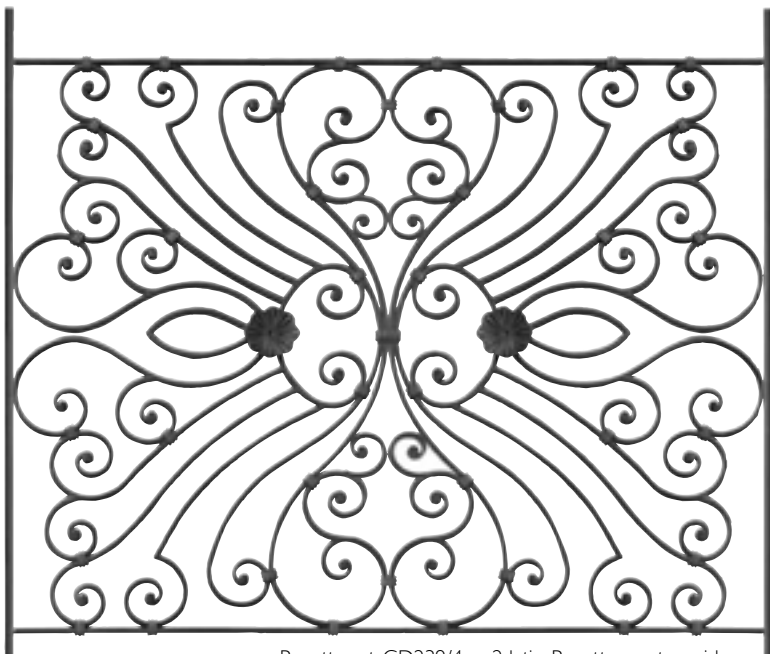

Rosette art. GD239/4 su 2 lati - Rosettes on two sides



Art. GD239/I

□ 14 × 8 mm

H 1000 mm

L 1185 mm



Rosette art. GD239/4 su 2 lati - Rosettes on two sides



Art. GD236/I

□ 14 × 8 mm

H 1000 mm

L 970 mm





Art. GD216/1

▧ 14 x 8 mm

H 1000 mm

L 470 mm

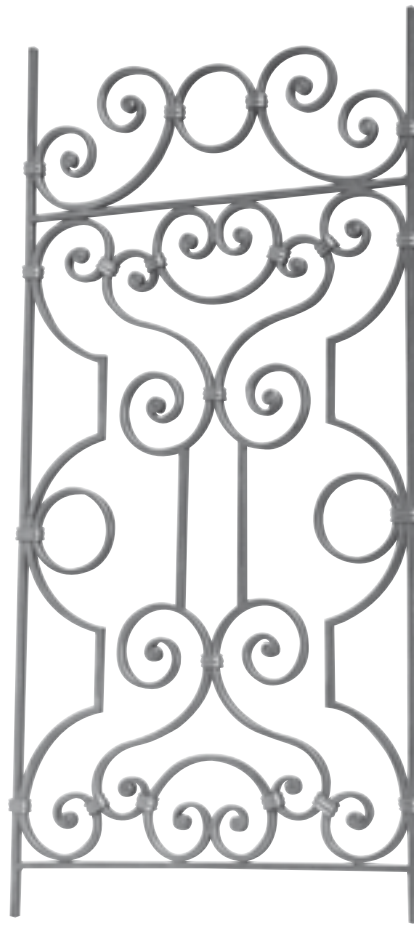

Art. GD216/3

▧ 14 x 8 mm

H 1000 mm

L 475 mm



Art. GD216/2

▧ 14 x 8 mm

H 1000 mm

L 240 mm

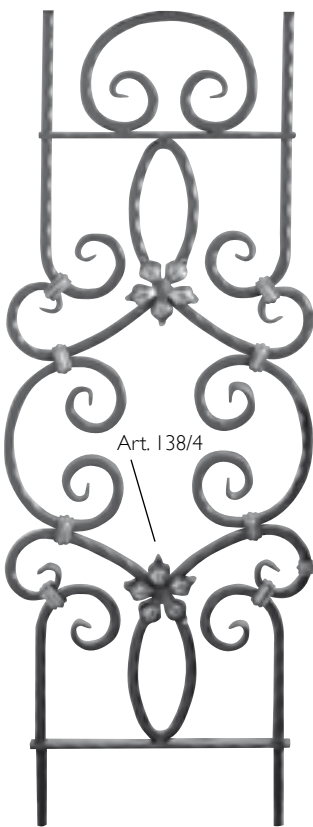

Art. GD102/1

⌀ 12 x 12 mm

H 1000 mm

L 380 mm



Art. GD105/1

▧ 14 x 8 mm

H 1000 mm

L 275 mm

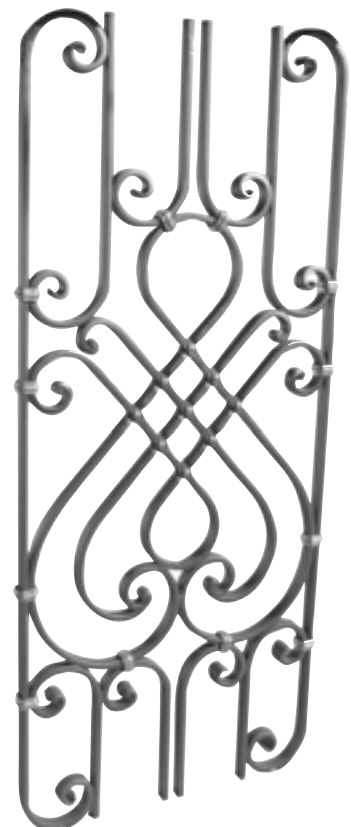

Art. GD99/1

▧ 16 x 8 mm

H 1000 mm

L 420 mm



art. 138/4 su 2 lati - on two sides

art. 116/A4 su 2 lati - on two sides

Art. 116/A4

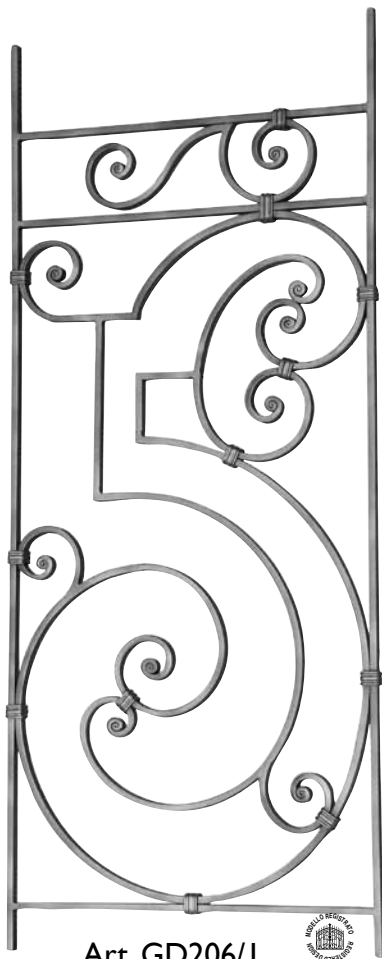

Art. GD206/1

□ 14 x 8 mm
H 1000 mm
L 420 mm



Art. GD206/2

□ 14 x 8 mm
H 1000 mm
L 485 mm



ARTEFERRO

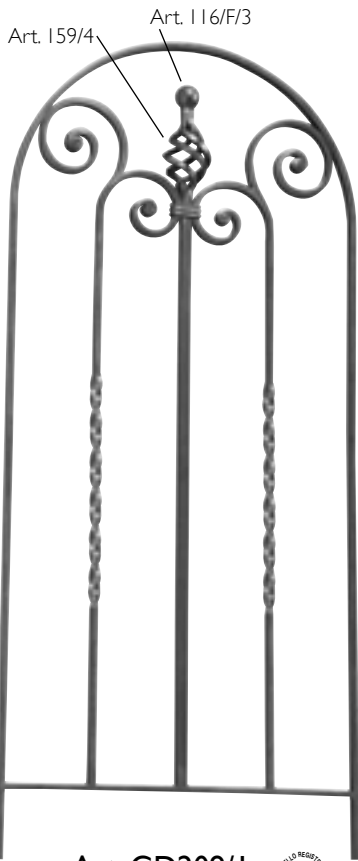

Art. GD209/1

□ 14 x 8 mm
H 1000 mm
L 440 mm

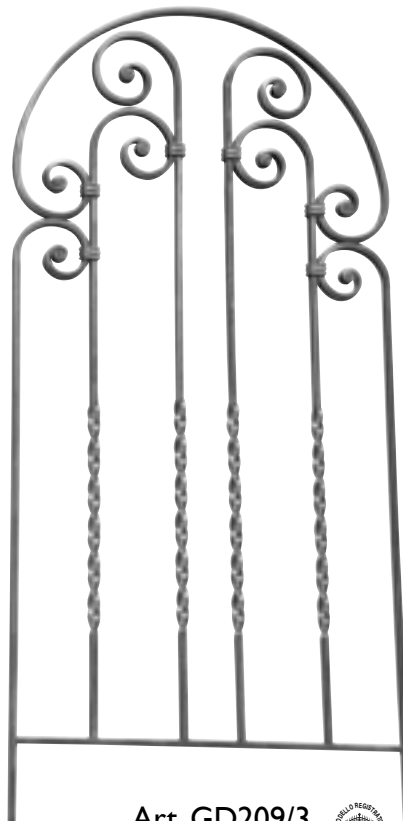

Art. GD209/3

□ 14 x 8 mm
H 1000 mm
L 480 mm

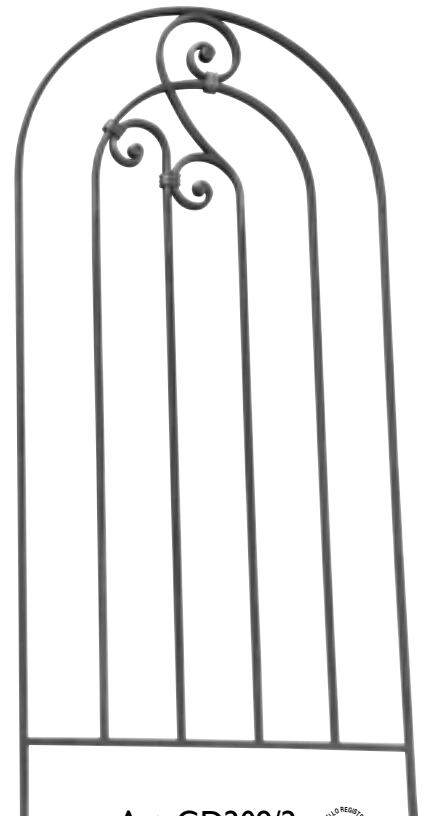

Art. GD209/2

□ 14 x 8 mm
H 1000 mm
L 475 mm



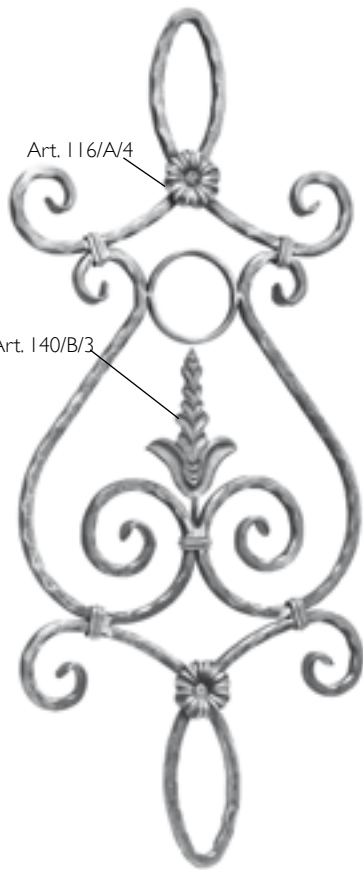

Art. 116/A/4

Art. 140/B/3

Art. 475/2
 Φ 12 x 12 mm
 H 900 mm
 L 380 mm
 spigolato
 hammered on edges



Art. 475/1
 Φ 12 x 12 mm
 H 825 mm
 L 380 mm
 spigolato
 hammered on edges



con medaglia in
 ottone with solid brass
 embellishment

Art. 476/1



con medaglia in
 legno with wooden
 embellishment

Art. 477/1



con medaglia in vetro
 with glass embellishment

Art. 478/2



ARTEFERRO



con medaglia in
 ottone with solid brass
 embellishment

Art. 476/2



con medaglia in
 legno with wooden
 embellishment

Art. 477/2



con medaglia in vetro
 with glass embellishment

Art. 478/1

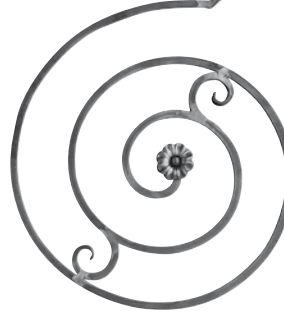
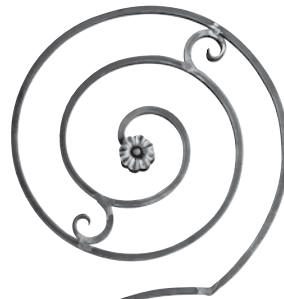

Art. 1038/1
 Φ 14 x 14 mm
 H 1080 mm
 L 510 mm
 liscio - plain



Art. 483/1
 Φ 14 x 14 mm
 H 1100 mm
 L 540 mm
 liscio - plain

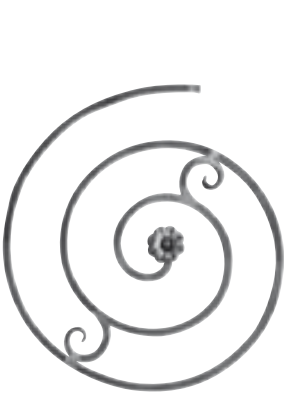

Art. 1038/2
 Φ 14 x 14 mm
 H 560 mm
 L 510 mm
 liscio - plain

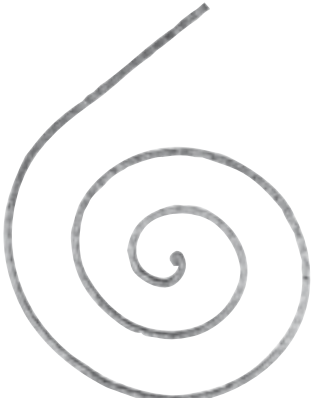

Art. 483/2
 Φ 14 x 14 mm
 H 700 mm
 L 550 mm
 magliato - hammered

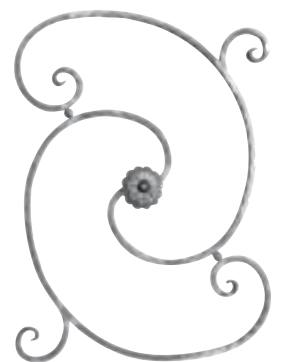

Art. 1040/1
 Φ 14 x 14 mm
 H 760 mm
 L 570 mm
 hammered on edges



Art. 1039/1
 Φ 14 x 14 mm
 H 760 mm
 L 570 mm
 hammered on edges

∅ = diameter



sinistra/left

∅ 12 mm
H 390 mm
L 280 mm

Art. 94/C/9
sinistra/left

Art. 94/C/10
destra/right



sinistra/left

∅ 12 mm
H 370 mm
L 330 mm

Art. 94/C/12
sinistra/left

Art. 94/C/11
destra/right

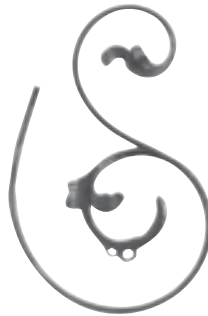

sinistra/left

∅ 12 mm
H 510 mm
L 330 mm

Art. 94/C/13
sinistra/left

Art. 94/C/14
destra/right



sinistra/left

∅ 12 mm
H 460 mm
L 440 mm

Art. 94/E/2
sinistra/left

Art. 94/E/1
destra/right



sinistra/left

∅ 12 mm
H 540 mm
L 310 mm

Art. 94/E/3
sinistra/left

Art. 94/E/4
destra/right



sinistra/left

∅ 12 mm
H 620 mm
L 410 mm

Art. 94/E/6
sinistra/left

Art. 94/E/5
destra/right



sinistra/left

∅ 12 mm
H 970 mm
L 420 mm

Art. 94/F/5
sinistra/left

Art. 94/F/6
destra/right



sinistra/left

∅ 12 mm
H 800 mm
L 490 mm

Art. 94/F/3
sinistra/left

Art. 94/F/4
destra/right



sinistra/left

∅ 12 mm
H 690 mm
L 320 mm

Art. 94/F/1
sinistra/left

Art. 94/F/2
destra/right



sinistra/left

∅ 12 mm
H 520 mm
L 320 mm

Art. 670/4
sinistra/left

Art. 670/3
destra/right



sinistra/left

∅ 12 mm
H 490 mm
L 420 mm

Art. 671/4
sinistra/left

Art. 671/3
destra/right



Art. 673/2

sinistra/left

∅ 12 mm
H 500 mm
L 300 mm

Art. 670/1
sinistra/left

Art. 670/2
destra/right



sinistra/left

∅ 12 mm
H 390 mm
L 315 mm

Art. 671/1
sinistra/left

Art. 671/2
destra/right



sinistra/left

∅ 12 mm
H 700 mm
L 390 mm

Art. 668/4
sinistra/left

Art. 668/3
destra/right



sinistra/left

∅ 12 mm
H 820 mm
L 460 mm

Art. 668/2
sinistra/left

Art. 668/1
destra/right



sinistra/left

Ø 12 mm
H 740 mm
L 320 mm

Art. 685/1
sinistra/left

Art. 685/2
destra/right



sinistra/left

Ø 12 mm
H 590 mm
L 240 mm

Art. 685/3
sinistra/left

Art. 685/4
destra/right



sinistra/left

Ø 12 mm
H 810 mm
L 360 mm

Art. 685/5
sinistra/left

Art. 685/6
destra/right



sinistra/left

Ø 12 mm
H 950 mm
L 340 mm

Art. 685/7
sinistra/left

Art. 685/8
destra/right



sinistra/left

Ø 16 x 8 mm
H 740 mm
L 320 mm

Art. 681/4
sinistra/left

Art. 681/3
destra/right



sinistra/left

Ø 16 x 8 mm
H 600 mm
L 270 mm

Art. 681/1
sinistra/left

Art. 681/2
destra/right

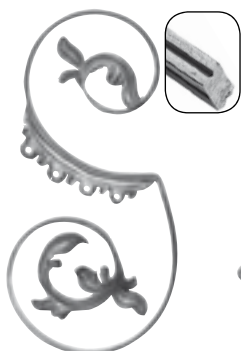

sinistra/left

Ø 16 x 8 mm
H 580 mm
L 300 mm

Art. 682/4
sinistra/left

Art. 682/5
destra/right

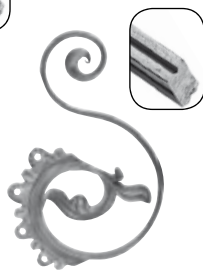

sinistra/left

Ø 16 x 8 mm
H 380 mm
L 240 mm

Art. 682/6
sinistra/left

Art. 682/7
destra/right

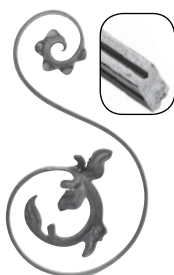

sinistra/left

Ø 16 x 8 mm
H 460 mm
L 240 mm

Art. 682/1
sinistra/left

Art. 682/2
destra/right

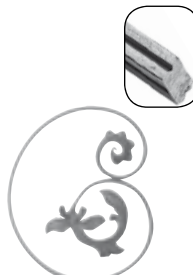

sinistra/left
rigato - grooved

Ø 16 x 8 mm
H 300 mm
L 240 mm

Art. 683/3
sinistra/left

Art. 683/4
destra/right



sinistra/left

Ø 16 x 8 mm
H 300 mm
L 240 mm

Art. 681/5
sinistra/left

Art. 681/6
destra/right



sinistra/left

Ø 16 x 8 mm
H 410 mm
L 330 mm

Art. 681/7
sinistra/left

Art. 681/8
destra/right

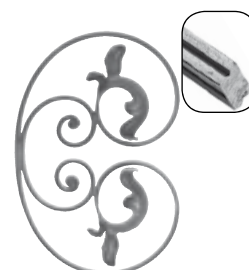

Art. 682/3
Ø 16 x 8 mm
H 410 mm
L 280 mm

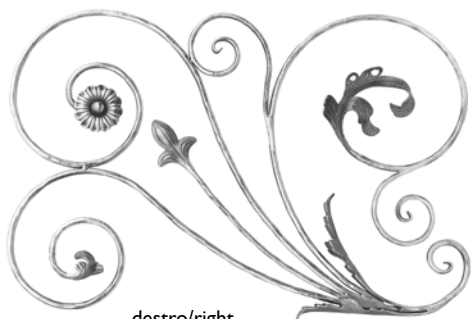

destro/right

Ø 12 mm

H 580 mm - L 880 mm



Art. 715/1
sinistra/left

Art. 715/2
destra/right



Ø 12 mm

H 580 mm - L 1780 mm



Art. 713/2

Ø = diameter



sinistra/left

Ø 12 mm

H 1280 mm - L 920 mm



Art. 716/1
sinistra/left

Art. 716/2
destra/right



Ø 12 mm

H 1150 mm - L 1600 mm



Art. 714/1



destro/right

Ø 12 mm

H 760 mm - L 890 mm



Art. 716/3
sinistra/left

Art. 716/4
destra/right



Ø 12 mm

H 760 mm - L 1780 mm



Art. 713/1



ARTEFERRO



ARTEFERRO



ARTEFERRO



Art. 1043/1
 Φ 12 x 12 mm
 H 1030 mm
 L 210 mm



Art. 1043/2
 Φ 12 x 12 mm
 H 1030 mm
 L 490 mm



Art. 1046/1
 Φ 12 x 12 mm
 H 900 mm
 L 250 mm



Art. 1046/2
 Φ 12 x 12 mm
 H 900 mm
 L 200 mm



Art. 511/1
 Φ 12 x 12 mm
 H 900 mm
 L 125 mm



Art. 510/1
 Φ 12 x 12 mm
 H 900 mm
 L 250 mm



Art. GD86/1
 Φ 12 x 12 mm
 H 1000 mm
 L 230 mm

Rosette 116/A/4 sui due lati - Rosettes 116/A/4 on both sides



Art. 1682/2
 Φ 14 x 14 mm
 H 1000 mm
 L 140 mm

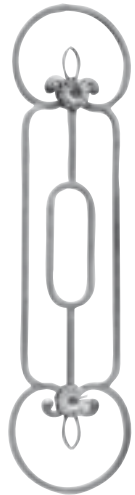

Art. 1685/1
 Φ 14 x 14 mm
 H 1000 mm
 L 245 mm



Art. 1685/2
 Φ 14 x 14 mm
 H 1000 mm
 L 245 mm

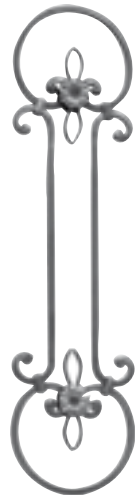

Art. 1682/1
 Φ 14 x 14 mm
 H 1000 mm
 L 245 mm



Art. 1142/1
 Φ 12 x 12 mm
 H 1000 mm
 L 180 mm



Art. 1142/2
 Φ 12 x 12 mm
 H 1000 mm
 L 280 mm



Art. 1741/3
 Φ 12 x 12 mm
 H 1000 mm
 L 280 mm

PANNELLI - PANELS

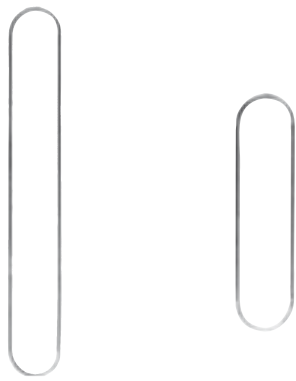

Art. 543/1

∅ 14 x 8 mm
H 850 mm
L 120 mm

Art. 543/2

∅ 14 x 8 mm
H 500 mm
L 120 mm

Art. 543/3

∅ 14 x 8 mm
H 500 mm
L 120 mm

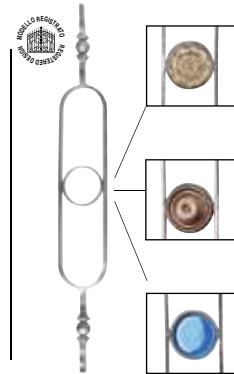
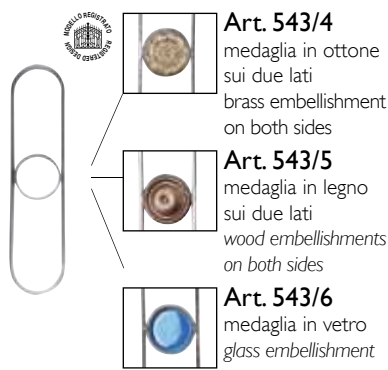

Art. 556/1

medaglia in ottone
sui due lati
brass embellishment
on both sides

Art. 557/1

medaglia in legno
sui due lati
wood embellishments
on both sides

Art. 558/1

medaglia in vetro
glass embellishment

Art. 555/1

∅ 12 x 6 mm
H 900 mm
L 120 mm

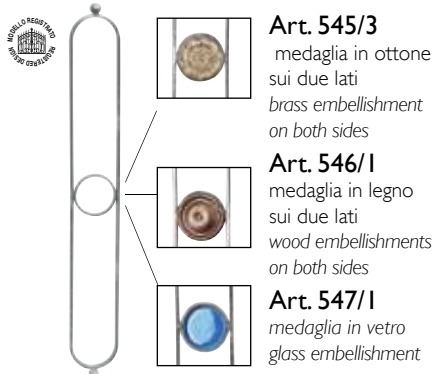

Art. 545/3

medaglia in ottone
sui due lati
brass embellishment
on both sides

Art. 546/1

medaglia in legno
sui due lati
wood embellishments
on both sides

Art. 547/1

medaglia in vetro
glass embellishment



Art. 545/2

2 medaglie in ottone
sui due lati
2 brass embellishment
on both sides

Art. 546/2

2 medaglie in legno
sui due lati
2 wood embellishments
on both sides

Art. 547/2

2 medaglie in vetro
2 glass embellishment

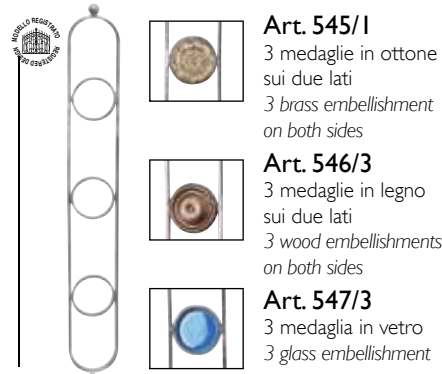

Art. 545/1

3 medaglie in ottone
sui due lati
3 brass embellishment
on both sides

Art. 546/3

3 medaglie in legno
sui due lati
3 wood embellishments
on both sides

Art. 547/3

3 medaglia in vetro
3 glass embellishment

Art. 544/3

∅ 14 x 8 mm
H 900 mm
L 120 mm

Art. 544/2

∅ 14 x 8 mm
H 900 mm
L 120 mm

Art. 544/1

∅ 14 x 8 mm
H 900 mm
L 120 mm

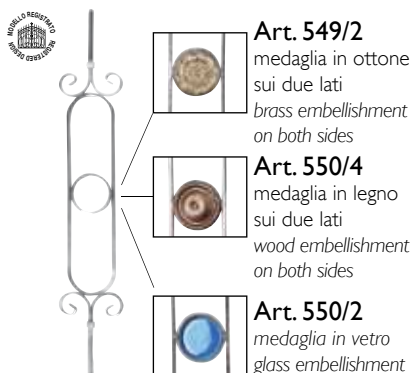

Art. 549/2

medaglia in ottone
sui due lati
brass embellishment
on both sides

Art. 550/4

medaglia in legno
sui due lati
wood embellishment
on both sides

Art. 550/2

medaglia in vetro
glass embellishment

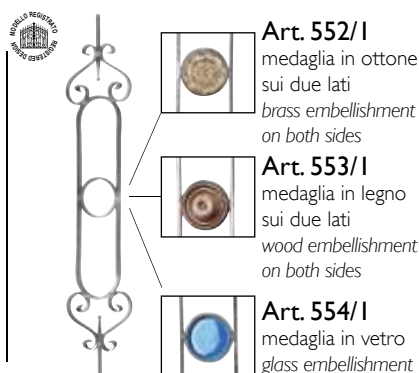

Art. 552/1

medaglia in ottone
sui due lati
brass embellishment
on both sides

Art. 553/1

medaglia in legno
sui due lati
wood embellishment
on both sides

Art. 554/1

medaglia in vetro
glass embellishment



Art. 549/1

medaglia in ottone
sui due lati
brass embellishment
on both sides

Art. 550/3

medaglia in legno
sui due lati
wood embellishment
on both sides

Art. 550/1

medaglia in vetro
glass embellishment

Art. 548/2

∅ 12 x 6 mm
H 900 mm
L 160 mm

Art. 551/1

∅ 12 x 6 mm
H 900 mm
L 175 mm

Art. 548/1

∅ 12 x 6 mm
H 900 mm
L 180 mm

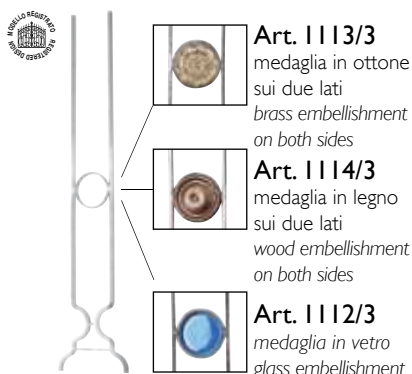

Art. 1113/3

medaglia in ottone
sui due lati
brass embellishment
on both sides

Art. 1114/3

medaglia in legno
sui due lati
wood embellishment
on both sides

Art. 1112/3

medaglia in vetro
glass embellishment

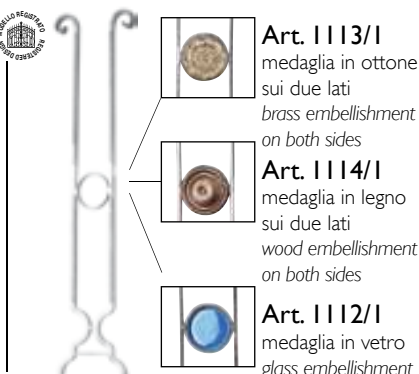

Art. 1113/1

medaglia in ottone
sui due lati
brass embellishment
on both sides

Art. 1114/1

medaglia in legno
sui due lati
wood embellishment
on both sides

Art. 1112/1

medaglia in vetro
glass embellishment

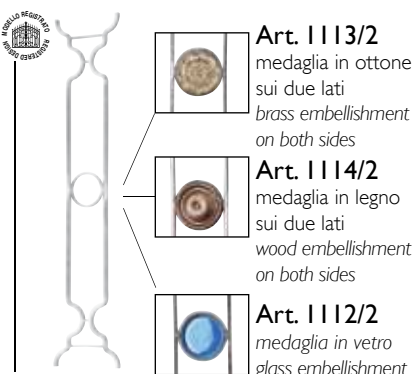

Art. 1113/2

medaglia in ottone
sui due lati
brass embellishment
on both sides

Art. 1114/2

medaglia in legno
sui due lati
wood embellishment
on both sides

Art. 1112/2

medaglia in vetro
glass embellishment

Art. 1111/3

∅ 12 x 12 mm
H 1000 mm
L 205 mm

Art. 1111/1

∅ 12 x 12 mm
H 1000 mm
L 240 mm

Art. 1111/2

∅ 12 x 12 mm
H 1000 mm
L 205 mm



Art. 1116/1
 ∅ 20 x 8 mm
 H 1000 mm
 L 265 mm



Art. 1116/2
 ∅ 20 x 8 mm
 H 1000 mm
 L 245 mm



Art. 1116/3
 ∅ 20 x 6 mm
 H 1000 mm
 L 150 mm



Art. 1116/4
 ∅ 20 x 6 mm
 H 1000 mm
 L 180 mm



Art. 1117/1
 ∅ 20 x 6 mm
 H 1000 mm
 L 130 mm



Art. 1117/2
 ∅ 20 x 6 mm
 H 1000 mm
 L 135 mm



Art. 1117/3
 ∅ 20 x 6 mm
 H 1000 mm
 L 175 mm



Art. 1107/1
 medaglia in ottone
 sui due lati
 brass embellishment
 on both sides



Art. 1109/1
 medaglia in legno
 sui due lati
 wood embellishment
 on both sides



Art. 1106/1
 medaglia in vetro
 glass embellishment

Art. 1105/1

∅ 12 x 12 mm
 H 1000 mm
 L 210 mm

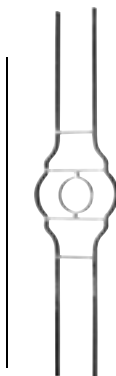

Art. 1103/1
 medaglia in ottone
 sui due lati
 brass embellishment
 on both sides



Art. 1104/1
 medaglia in legno
 sui due lati
 wood embellishment
 on both sides



Art. 1102/1
 medaglia in vetro
 glass embellishment

Art. 1101/1

∅ 20 x 8 mm
 H 1000 mm
 L 240 mm

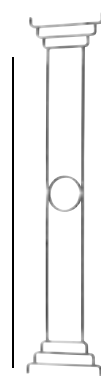

Art. 1118/3
 medaglia in ottone
 sui due lati
 brass embellishment
 on both sides



Art. 1118/4
 medaglia in legno
 sui due lati
 wood embellishment
 on both sides



Art. 1118/2
 medaglia in vetro
 glass embellishment

Art. 1118/1

∅ 12 x 6 mm
 H 1000 mm
 L 215 mm



ARTEFERRO

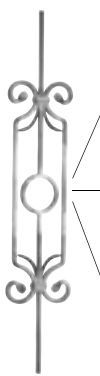

Art. 1034/1
 medaglia in ottone
 sui due lati
 brass embellishment
 on both sides



Art. 1035/1
 medaglia in legno
 sui due lati
 wood embellishment
 on both sides



Art. 1033/1
 medaglia in vetro
 glass embellishment

Art. 1032/1
 ∅ 12 x 12 mm
 H 1000 mm
 L 190 mm

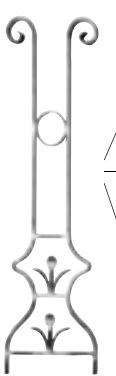

Art. 1099/2
 medaglia in ottone
 sui due lati
 brass embellishment
 on both sides



Art. 1100/2
 medaglia in legno
 sui due lati
 wood embellishment
 on both sides



Art. 1098/2
 medaglia in vetro
 glass embellishment

Art. 1097/1
 ∅ 12 x 12 mm
 H 1000 mm
 L 305 mm



Art. 1034/2
 medaglia in ottone
 sui due lati
 brass embellishment
 on both sides



Art. 1035/2
 medaglia in legno
 sui due lati
 wood embellishment
 on both sides



Art. 1033/2
 medaglia in vetro
 glass embellishment

Art. 1032/2
 ∅ 12 x 12 mm
 H 1000 mm
 L 230 mm

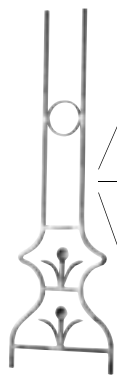

Art. 1099/1
 medaglia in ottone
 sui due lati
 brass embellishment
 on both sides



Art. 1100/1
 medaglia in legno
 sui due lati
 wood embellishment
 on both sides



Art. 1098/1
 medaglia in vetro
 glass embellishment

Art. 1097/2
 ∅ 12 x 12 mm
 H 1000 mm
 L 305 mm

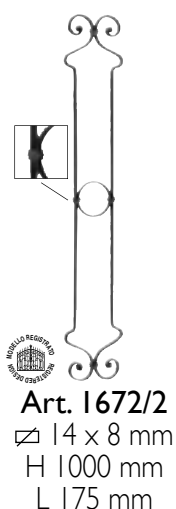

Art. 1672/2
 □ 14 x 8 mm
 H 1000 mm
 L 175 mm

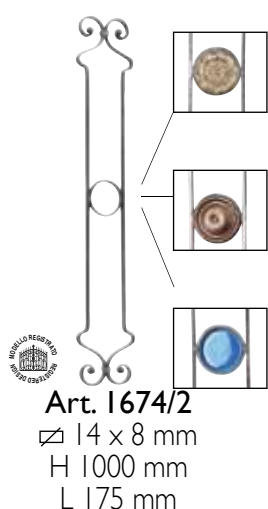

Art. 1674/2
 □ 14 x 8 mm
 H 1000 mm
 L 175 mm

Art. 1676/2
 medaglia in ottone
 sui due lati
*brass embellishment
 on both sides*

Art. 1677/2
 medaglia in legno
 sui due lati
*wood embellishment
 on both sides*

Art. 1675/2
 medaglia in vetro
glass embellishment

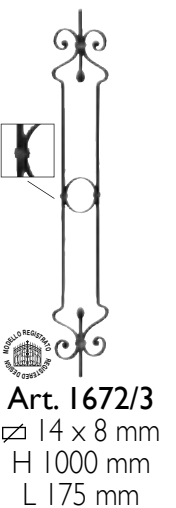

Art. 1672/3
 □ 14 x 8 mm
 H 1000 mm
 L 175 mm

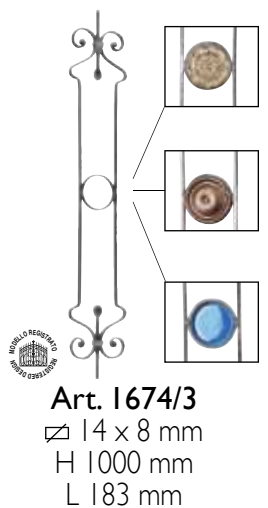

Art. 1674/3
 □ 14 x 8 mm
 H 1000 mm
 L 183 mm

Art. 1676/3
 medaglia in ottone
 sui due lati
*brass embellishment
 on both sides*

Art. 1677/3
 medaglia in legno
 sui due lati
*wood embellishment
 on both sides*

Art. 1675/3
 medaglia in vetro
glass embellishment

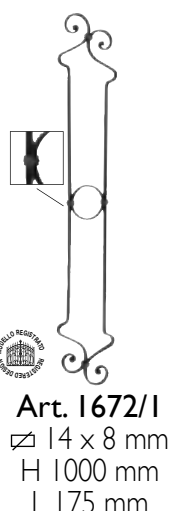

Art. 1672/1
 □ 14 x 8 mm
 H 1000 mm
 L 175 mm

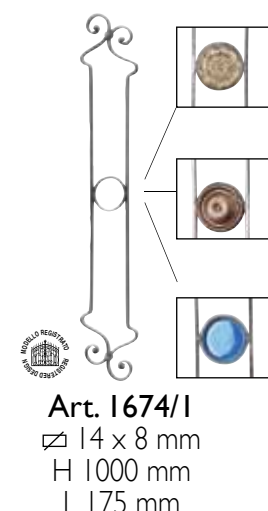

Art. 1674/1
 □ 14 x 8 mm
 H 1000 mm
 L 175 mm

Art. 1676/1
 medaglia in ottone
 sui due lati
*brass embellishment
 on both sides*

Art. 1677/1
 medaglia in legno
 sui due lati
*wood embellishment
 on both sides*

Art. 1675/1
 medaglia in vetro
glass embellishment

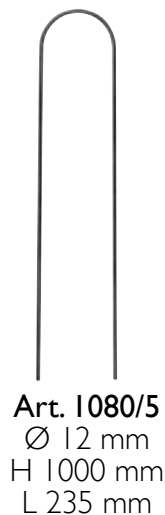

Art. 1080/5
 Ø 12 mm
 H 1000 mm
 L 235 mm

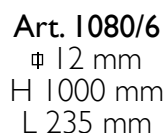

Art. 1080/6
 φ 12 mm
 H 1000 mm
 L 235 mm

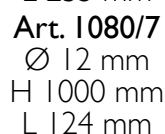

Art. 1080/7
 Ø 12 mm
 H 1000 mm
 L 124 mm



Art. 1080/8
 φ 12 mm
 H 1000 mm
 L 124 mm

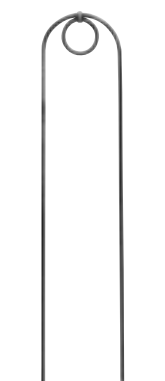

Art. 1080/3
 Ø 12 mm
 H 1000 mm
 L 235 mm

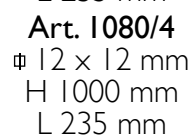

Art. 1080/4
 □ 12 x 12 mm
 H 1000 mm
 L 235 mm

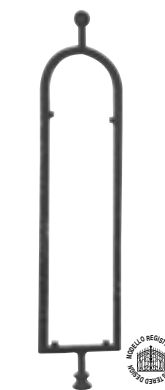

Art. 1115/3
 φ 20 x 20 mm
 H 1000 mm
 L 270 mm

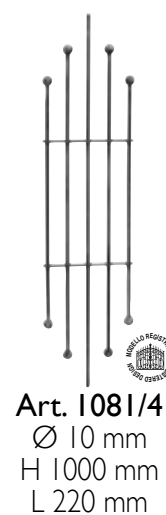

Art. 1081/4
 Ø 10 mm
 H 1000 mm
 L 220 mm

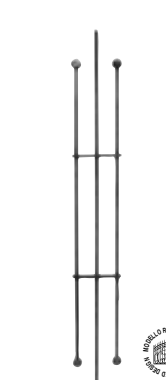

Art. 1081/3
 Ø 10 mm
 H 1000 mm
 L 120 mm

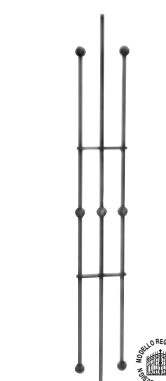

Art. 1081/2
 Ø 10 mm
 H 1000 mm
 L 120 mm



Art. 1081/1
 Ø 10 mm
 H 1000 mm
 L 120 mm

Art. 1751/6



Art. 1751/1
 φ 20 x 20 mm
 H 1000 mm
 L 185 mm



Art. 1751/3
 φ 20 x 20 mm
 H 1000 mm
 L 185 mm



Art. 1751/2
 φ 20 x 20 mm
 H 1000 mm
 L 185 mm



Art. 1751/4
 φ 20 x 20 mm
 H 1000 mm
 L 185 mm



Art. 64/B/3
 Ø 12 x 12 mm
 H 900 mm
 L 255 mm



Art. 65/5
 Ø 12 x 12 mm
 H 820 mm
 L 242 mm



Art. 65/1
 Ø 12 x 12 mm
 H 820 mm
 L 160 mm



Art. 65/3
 Ø 12 x 12 mm
 H 630 mm
 L 160 mm



Art. 472/1
 Ø 12 x 12 mm
 H 900 mm
 L 395 mm



ARTEFERRO



Art. 1292/1
 Ø 10 mm
 230 x 900 mm



Art. 1292/2
 Ø 10 mm
 230 x 900 mm



Art. 1292/3
 Ø 10 mm
 230 x 900 mm



Art. 1303/4
 Ø 10 mm
 65 x 780 mm



Art. 1303/5
 Ø 10 mm
 90 x 565 mm



Art. 1303/6
 Ø 10 mm
 105 x 550 mm



Art. 484/1
 Ø 12 x 12 mm
 H 900 mm
 L 340 mm



Art. 473/1
 Ø 12 x 12 mm
 H 900 mm
 L 380 mm



Art. 486/2
 Ø 16 x 8 mm
 H 700 mm
 L 300 mm



Art. 116/E/5
 Ø 12 x 12 mm
 H 650 mm
 L 200 mm



Art. 474/1
 Ø 12 x 12 mm
 H 755 mm
 L 380 mm



PANNELLI - PANELS



Art. 1657/2
 ∅ 16 x 8 mm
 H 1000 mm
 L 100 mm



Art. 1657/3
 ∅ 16 x 8 mm
 H 1000 mm
 L 100 mm



Art. 479/1
 ∅ 12 x 12 mm
 H 900 mm
 L 110 mm



Art. 1641/3
 ∅ 12 x 12 mm
 H 900 mm
 L 110 mm



Art. 1655/4
 ∅ 12 x 6 mm
 H 1000 mm
 L 100 mm



Art. 1678/1
 ∅ 14 x 8 mm
 H 1000 mm
 L 100 mm



Art. 498/1
 ∅ 12 mm
 H 650 mm



Forgiati/Hot forged



Art. 498/2
 ∅ 12 mm
 H 650 mm



Art. 59/3
 ∅ 20 x 4 mm
 H 720 mm
 L 175 mm



Art. 59/1
 ∅ 20 x 4 mm
 H 850 mm
 L 170 mm



Art. 59/2
 ∅ 20 x 4 mm
 H 850 mm
 L 170 mm



Art. 59/7
 ∅ 20 x 4 mm
 H 720 mm
 L 175 mm

Art. 59/4
 ∅ 20 x 4 mm
 H 820 mm
 L 175 mm

Art. 59/8
 ∅ 20 x 4 mm
 H 820 mm
 L 175 mm



Art. 456/1
 ∅ 12 x 12 mm
 H 1020 mm
 L 400 mm

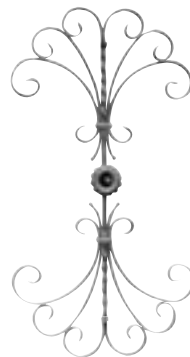

Art. 456/3
 ∅ 12 x 6 mm
 H 1020 mm
 L 545 mm



Art. 64/2
 ∅ 8 x 8 mm
 H 850 mm
 L 140 mm



Art. 72/5
 ∅ 20 x 4 mm
 H 820 mm
 L 175 mm



Art. 59/5
 ∅ 20 x 4 mm
 H 720 mm
 L 175 mm

Art. 72/6
 ∅ 20 x 4 mm
 H 900 mm
 L 175 mm

Art. 59/6
 ∅ 20 x 4 mm
 H 820 mm
 L 175 mm



Art. 103/1
H 900 mm



Art. 103/2
φ 12 x 12 mm
H 900 mm



Art. 24/F/1
φ 12 x 12 mm
H 560 mm
L 300 mm



Art. 34/A/1
φ 12 x 6 mm
H 570 mm
L 280 mm



Art. 52/E/5
φ 12 x 12 mm
H 900 mm
L 300 mm



Art. 58/1
φ 8 x 8 mm
H 800 mm
L 270 mm



Art. 92/A/1
φ 10 x 5 mm
H 535 mm
L 300 mm

Art. 52/E/6

φ 12 x 12 mm
H 800 mm
L 300 mm



Art. 70/1
φ 16 x 4 mm
H 720 mm
L 333 mm

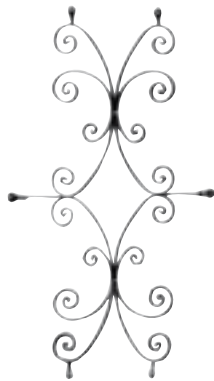

Art. 162/6
φ 16 x 4 mm
H 1030 mm
L 580 mm

staffe/stafs 10 x 10 mm

Art. 162/4
φ 10 x 5 mm
H 1030 mm
L 580 mm

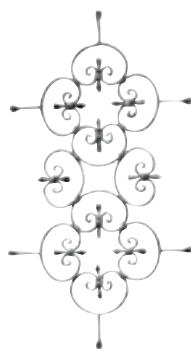

Art. 162/5
φ 10 x 5 mm
H 1030 mm
L 580 mm



Art. 69/3
φ 16 x 4 mm
H 540 mm
L 250 mm



Art. 453/8
φ 12 x 6 mm
H 480 mm
L 180 mm



Art. 453/9
φ 12 x 6 mm
H 405 mm
L 220 mm



Art. 51/3
φ 12 x 12 mm
H 900 mm
L 300 mm



Art. 471/1
φ 14 x 8 mm
H 900 mm
L 250 mm



Art. 69/1
φ 16 x 4 mm
H 720 mm
L 250 mm



Art. 69/2
φ 16 x 4 mm
H 720 mm
L 250 mm

Art. 185/6

zincato - galvanized
φ 12 x 12 mm
H 900 mm
L 300 mm



Art. 51/6
φ 14 x 14 mm
H 900 mm
L 300 mm



Art. 1753/4
φ 12 x 12 mm
H 1000 mm
L 300 mm



Art. 68/2
φ 8 x 8 mm
H 720 mm
L 250 mm



Art. 70/2
φ 20 x 4 mm
H 720 mm
L 240 mm



Art. 92/A/2
φ 12 x 6 mm
H 660 mm
L 163 mm



ARTEFERRO



Art. 1687/2
 Ø 12 x 12 mm
 H 1000 mm
 L 210 mm

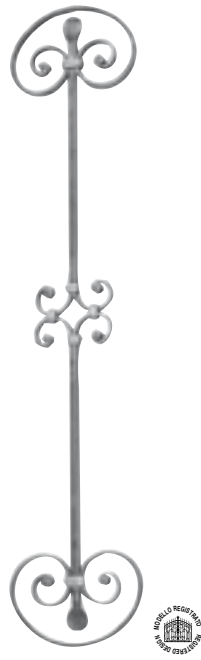

Art. 1687/1
 Ø 12 x 12 mm
 H 1000 mm
 L 210 mm



Art. 70/E/5
 Ø 12 x 12 mm
 H 820 mm



Art. 70/E/1
 Ø 12 x 12 mm
 H 720 mm

Art. 70/E/7

Ø 14 x 14 mm
 H 820 mm

Art. 70/E/3

Ø 14 x 14 mm
 H 720 mm

Art. 70/E/6

Ø 12 x 12 mm
 H 900 mm

Art. 70/E/2

Ø 12 x 12 mm
 H 820 mm

Art. 70/E/8

Ø 14 x 14 mm
 H 900 mm

Art. 70/E/4

Ø 14 x 14 mm
 H 820 mm



Art. 92/B/5

Ø 12 x 6 mm
 H 750 mm
 L 95 mm



spigolato - hammered on edges

Art. 656/1

Ø 16 x 8 mm
 H 690 mm
 L 110 mm



Art. 678/1

Ø 12 mm
 H 510 mm
 L 75 mm



rigato - grooved

Art. 678/2

Ø 16 x 8 mm
 H 510 mm
 L 75 mm



Art. 163/2
 Ø 12 x 12 mm
 H 530 mm
 L 205 mm



Art. 69/4
 Ø 16 x 4 mm
 H 540 mm
 L 250 mm



Art. 68/1
 Ø 16 x 4 mm
 H 720 mm
 L 250 mm



ARTEFERRO

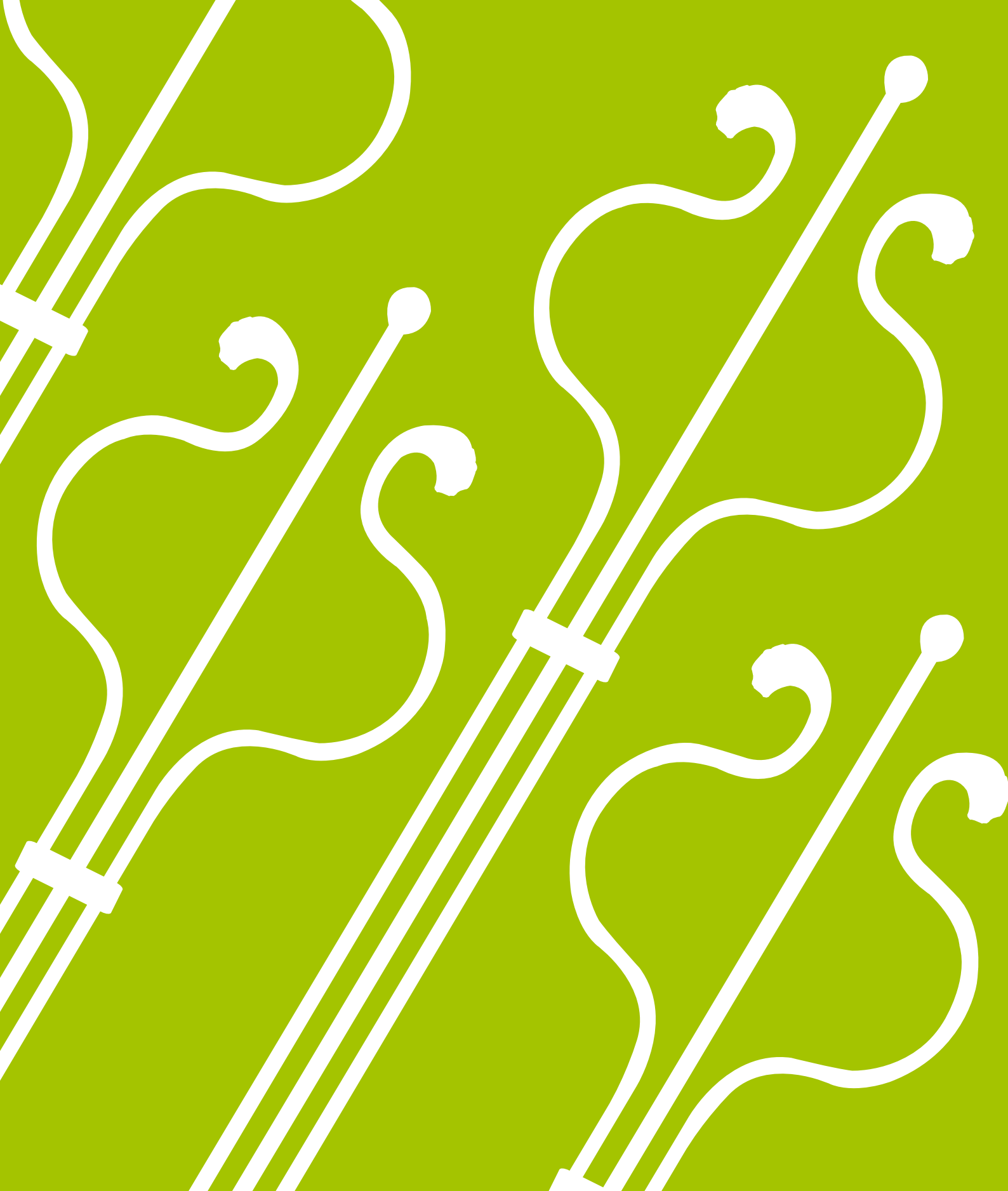

PALETTI - PICKETS

COMPENDIUM 2011

Art. 1075/I

Paletti Forgiati - Forged Pickets



Art. 105/2
 Φ 12 x 12 mm
 H 1000 mm



Art. 105/1
 Φ 12 x 12 mm
 H 1000 mm



Art. 1770/15
 Φ 12 x 12 mm
 H 1000 mm



Art. 1770/13
 Φ 12 x 12 mm
 H 1000 mm

Paletto liscio
 con borchia
 forgiata

Square plain
 with forged
 bush

Art. 1770/16
 Φ 14 x 14 mm
 H 1000 mm

Art. 1770/14
 Φ 14 x 14 mm
 H 1000 mm

FORGIATI SU MISURA
 A RICHIESTA
 FORGED PICKETS
 CUSTOM MADE UPON
 REQUEST

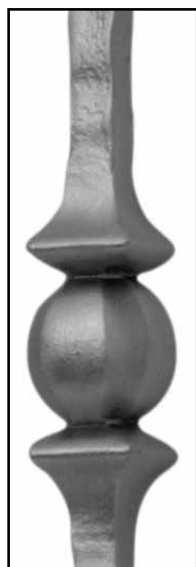

Art. 1159/5
 Φ 12 x 12 mm
 H 1200 mm



Art. 1159/6
 Φ 12 x 12 mm
 H 1200 mm



Paletto magliato
 Forged picket
Art. 105/3
 H 1000 mm
 Φ 14 x 14 mm

Art. 105/4
 H 1000 mm
 Φ 16 x 16 mm

Art. 105/5
 H 1000 mm
 Φ 12 x 12 mm

Art. 105/6
 H 1200 mm
 Φ 12 x 12 mm

Art. 105/7
 H 1200 mm
 Φ 14 x 14 mm



ARTEFERRO

CAPOSALDI CONSIGLIATI
 SUGGESTED NEWEL POSTS



Art. 112/7
 Φ 25 x 25 mm
 H 1200 mm



Art. 1769/5
 Φ 25 mm
 H 1200 mm



Art. 1769/7
 Φ 25 x 25 mm
 H 1200 mm

Art. 112/8
 Φ 30 x 30 mm
 H 1200 mm

Art. 1769/6
 Φ 30 mm
 H 1200 mm

Art. 1769/8
 Φ 30 x 30 mm
 H 1200 mm

Paletti Forgiati - Forged Pickets

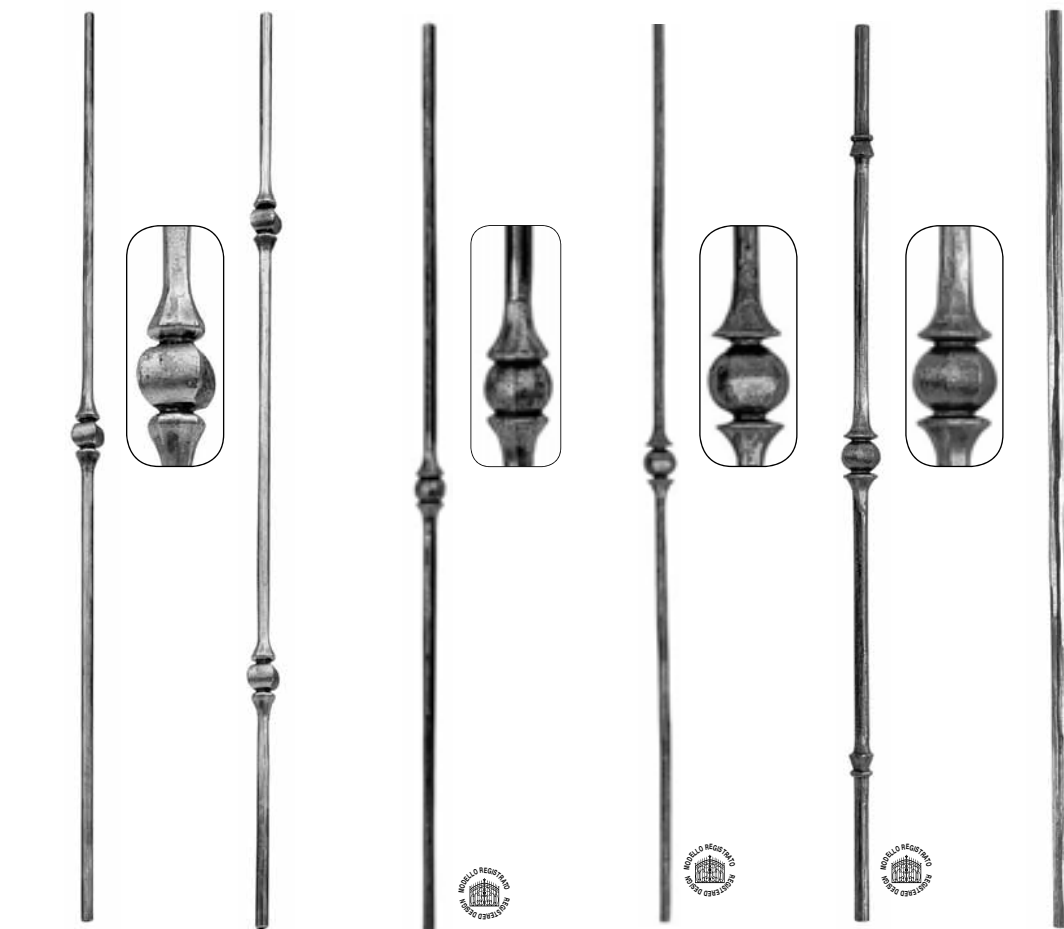

Art. 1769/1
 Ø 12 mm
 H 1000 mm

Art. 1769/2
 Ø 12 mm
 H 1000 mm

Art. 1187/4
 Ø 14 mm
 H 1000 mm

Art. 1184/4
 Ø 12 mm
 H 1000 mm

Art. 1192/7
 Ø 14 mm
 H 1000 mm

Paletto magliato
 Forged picket

Art. 1185/4
 Ø 12 mm
 H 1000 mm

Art. 1185/5
 Ø 14 mm
 H 1000 mm

Art. 1160/11
 Ø 12 mm
 H 1200 mm

Art. 1160/12
 Ø 16 mm
 H 1000 mm

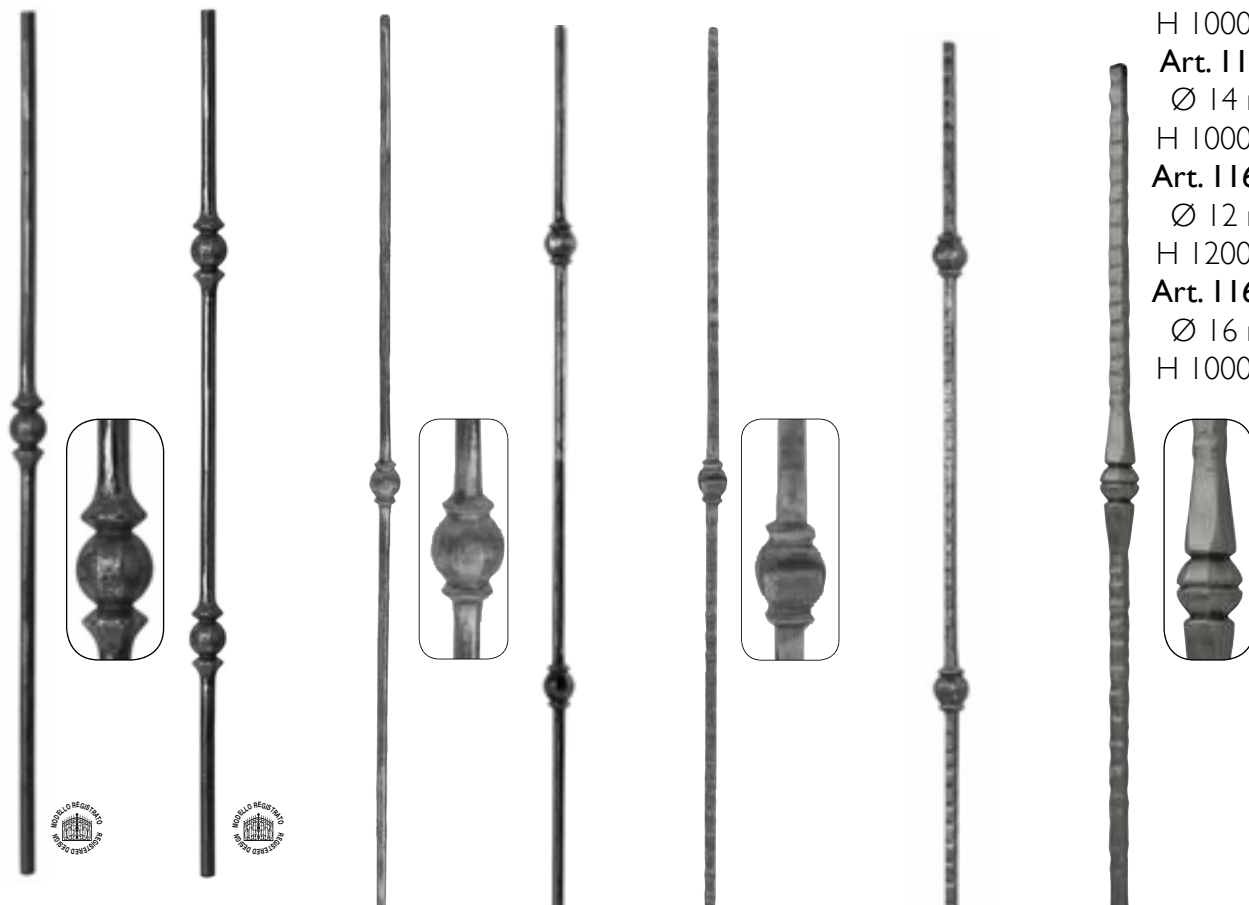

Art. 504/2
 Ø 14 mm
 H 1000 mm

Art. 504/3
 Ø 14 mm
 H 1000 mm

Art. 1770/4
 Ø 12 mm
 H 1000 mm

Art. 1771/4
 Ø 12 mm
 H 1000 mm

Art. 1770/8
 Ø 12 x 12 mm
 H 1000 mm

Art. 1771/8
 Ø 12 x 12 mm
 H 1000 mm

Art. 508/2
 Ø 18 x 18 mm
 H 900 mm

Paletti Forgiati - Forged Pickets



Art. 497/1
 Ø 12 mm
 H 1000 mm



Art. 497/2
 Ø 12 mm
 H 1000 mm



Art. 1770/6
 Ø 12 x 12 mm
 H 1000 mm



Art. 1771/6
 Ø 12 x 12 mm
 H 1000 mm



ARTEFERRO



Art. 1185/1
 Ø 12 x 12 mm
 H 1000 mm



Ø 14 mm

Art. 1770/10
 Ø 14 mm
 H 1000 mm



conico
 conic



Ø 14 mm

Art. 1770/9
 Ø 14 mm
 H 1000 mm

Ø 10 mm

CAPOSALDI CONSIGLIATI
 SUGGESTED NEWEL POSTS



Art. 797/5
 Ø 25 mm
 H 1200 mm



Art. 798/1
 Ø 30 mm
 H 1200 mm



Art. 112/11
 Ø 30 x 30 mm
 H 1200 mm



Art. 802/3
 Ø 25 mm
 H 1200 mm

Art. 797/1
 Ø 30 mm
 H 1200 mm

Paletti Forgiati - Forged Pickets

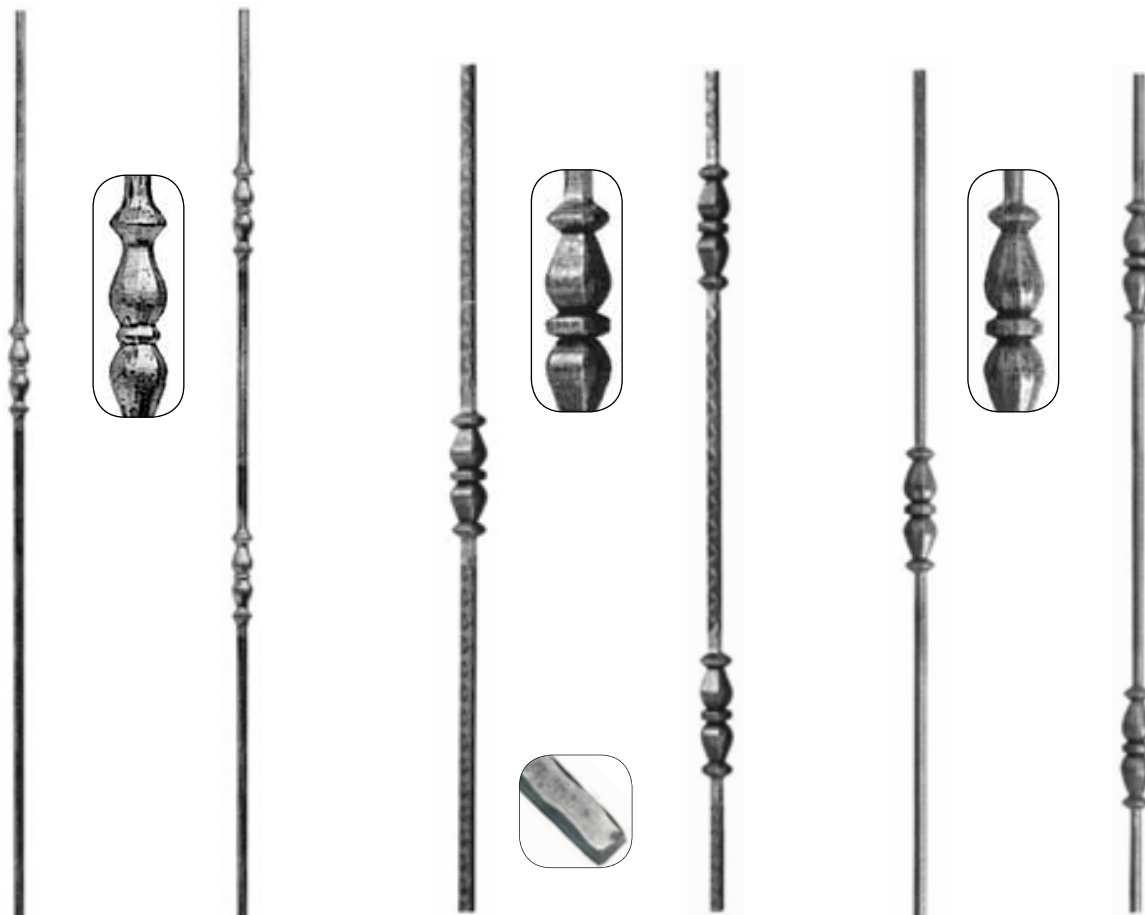

Art. 1159/3
 Ø 12 mm
 H 1200 mm

Art. 1159/4
 Ø 12 mm
 H 1200 mm

Art. 1189/1
 Ø 12 x 12 mm
 H 900 mm

Art. 1189/2
 Ø 12 x 12 mm
 H 900 mm

Art. 1189/3
 Ø 12 mm
 H 900 mm

Art. 1189/4
 Ø 12 mm
 H 900 mm



Paletti Forgiati - Forged Pickets



conico - conic

Art. 1187/3
 Ø 14 mm
 H 1000 mm



Art. 99/1
 12 x 12 mm
 H 1000 mm



Art. 99/2
 12 x 12 mm
 H 1000 mm

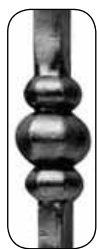

Paletto liscio con
 borchia forgiata

Square plain with
 forged bush

Art. 1770/11
 12 x 12 mm
 H 1000 mm

Art. 1770/12
 12 x 12 mm
 H 1000 mm

CAPOSALDI CONSIGLIATI
 SUGGESTED NEWEL POSTS



Art. 112/7
 25 x 25 mm
 H 1200 mm
Art. 112/8
 30 x 30 mm
 H 1200 mm



ARTEFERRO



ARTEFERRO

Paletti Forgiati - Forged Pickets

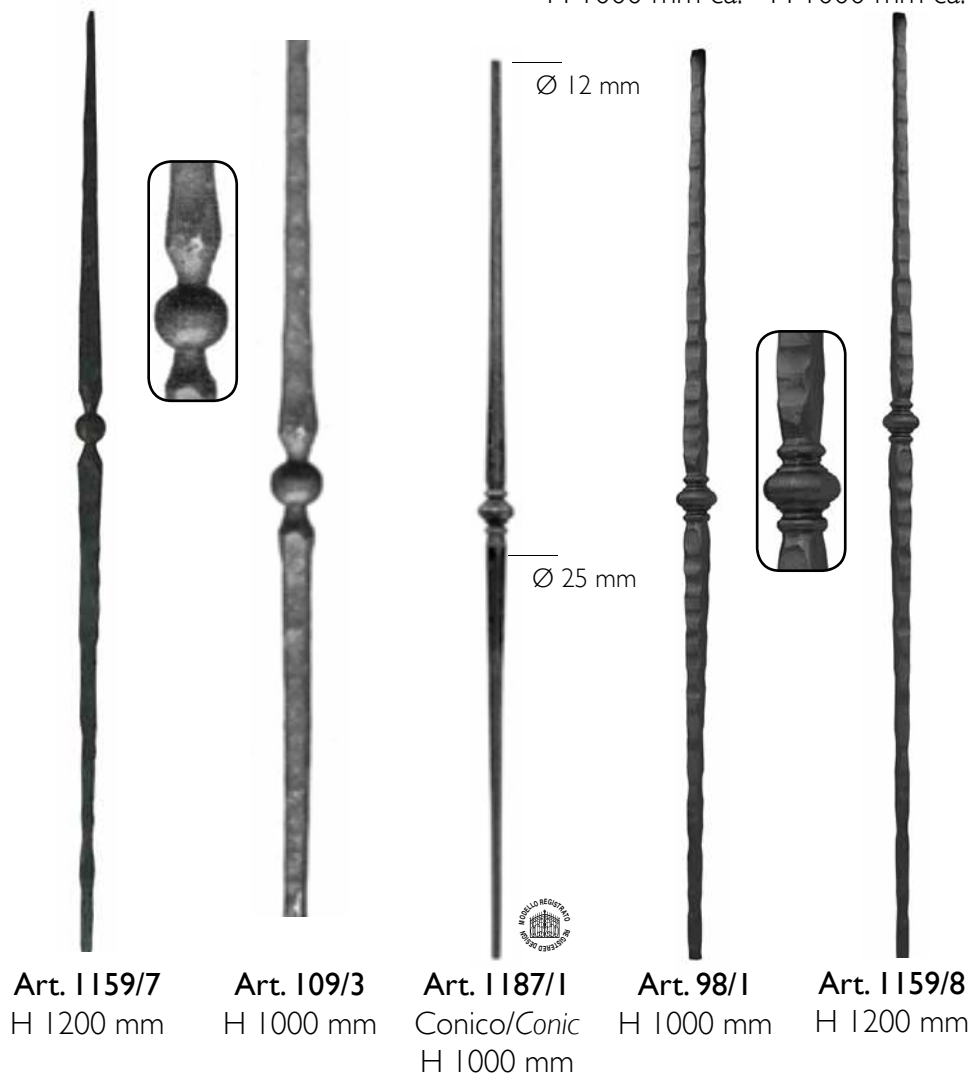
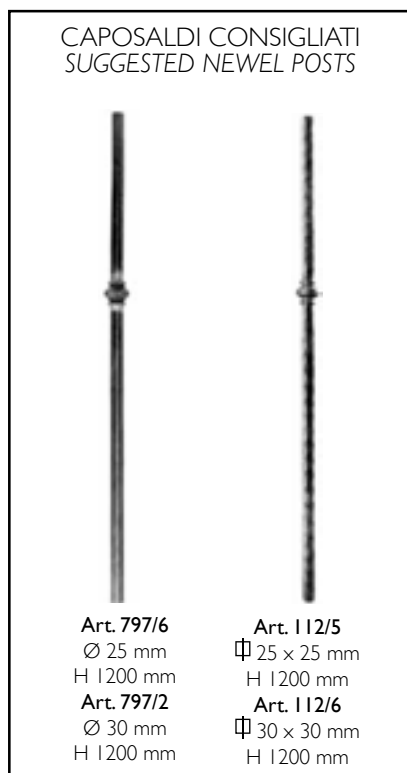
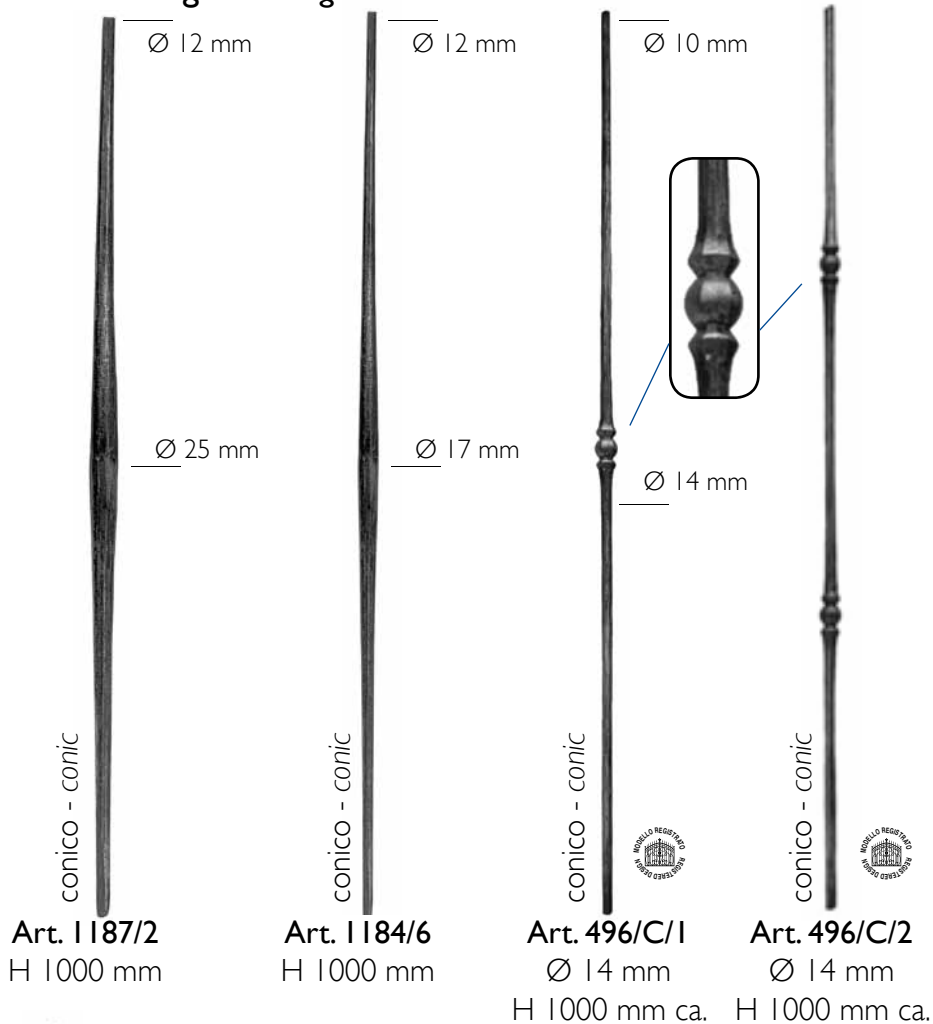

Paletti Forgiati - Forged Pickets

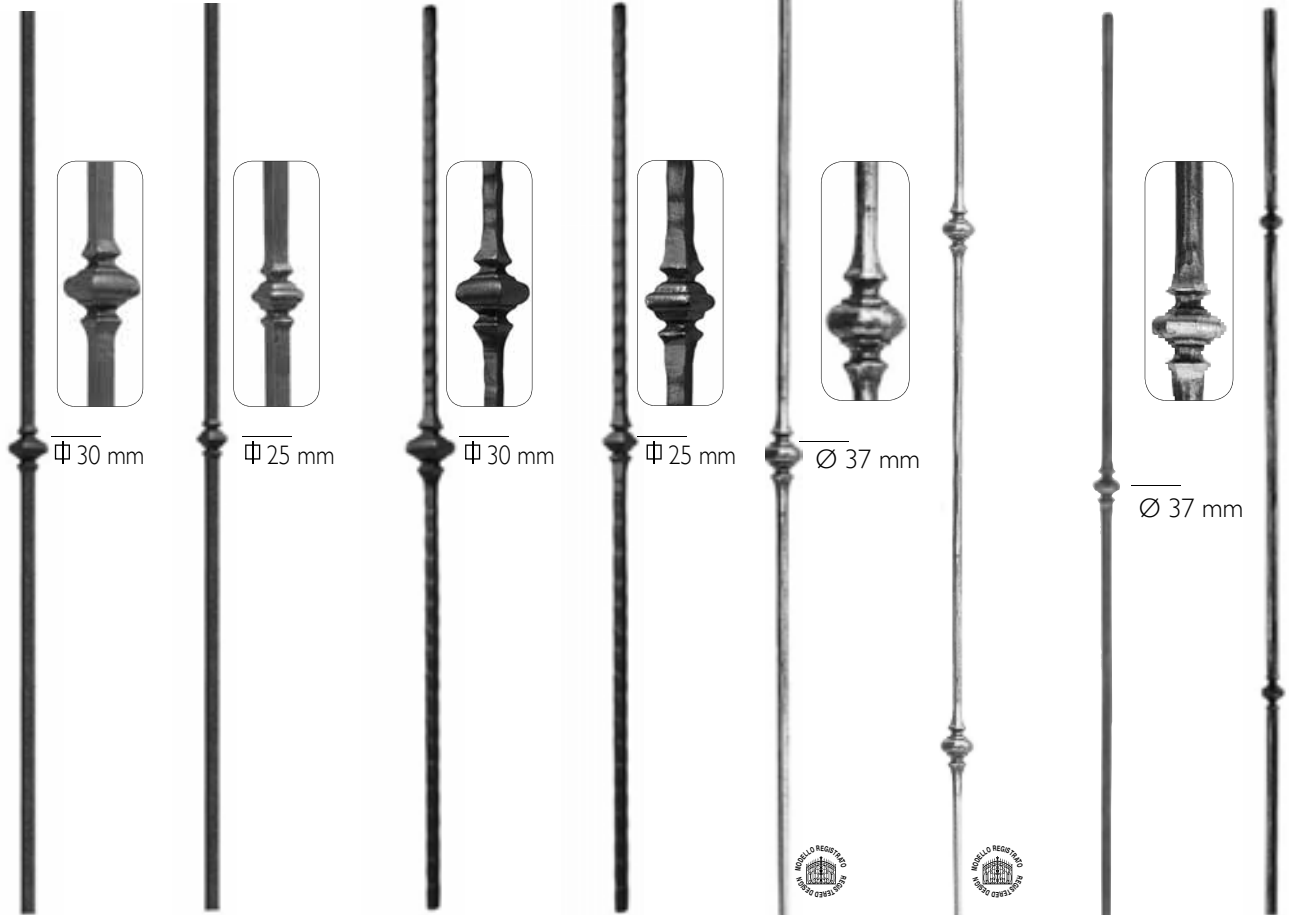

Art. GD248/1	Art. GD248/2	Art. GD248/3	Art. GD248/4	Art. 499/1	Art. 499/2	Art. 1770/3	Art. 1771/3
Φ 12 x 12 mm	Φ 12 x 12 mm	Φ 12 x 12 mm	Φ 12 x 12 mm	Ø 12 mm	Ø 12 mm	Ø 12 mm	Ø 12 mm
H 1000 mm	H 1000 mm	H 1000 mm	H 1000 mm	H 1000 mm	H 1000 mm	H 1000	H 1000

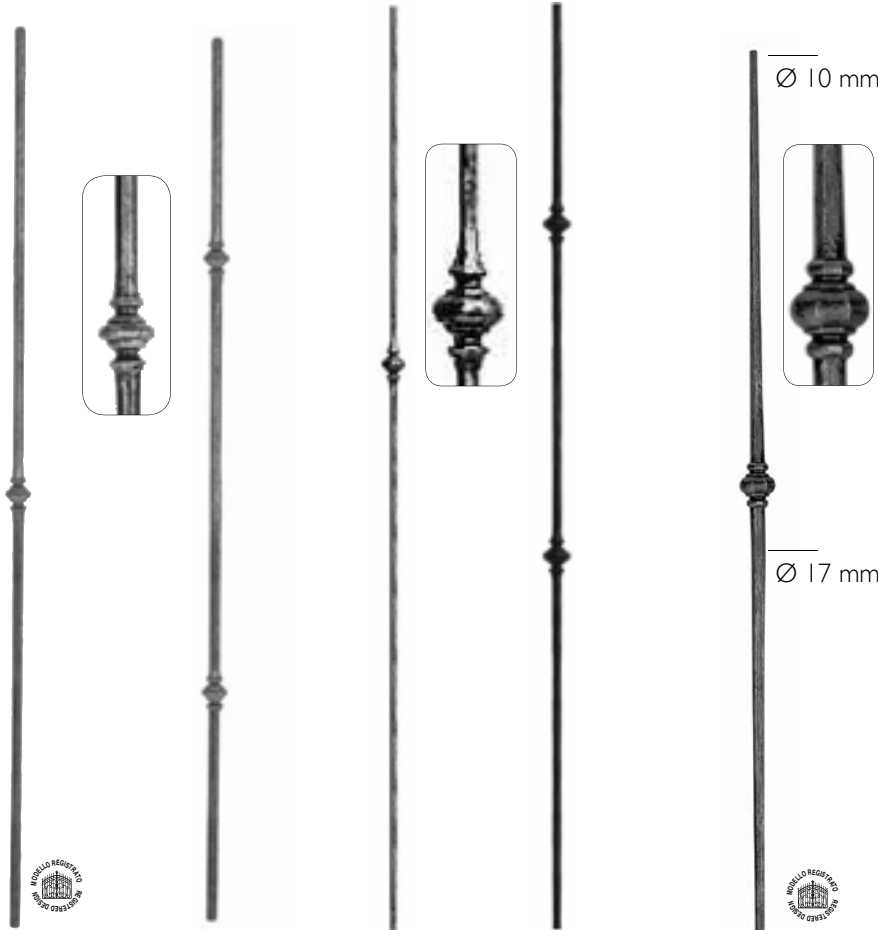

Art. 1770/2	Art. 1771/2	Art. 1159/1	Art. 1159/2	Art. 1184/5
Ø 12 mm	Ø 12 mm	Ø 12 mm	Ø 12 mm	Ø 10 mm
H 1000 mm	H 1000 mm	H 1200 mm	H 1200 mm	Ø 17 mm
				Conico/Conic

CAPOSALDI CONSIGLIATI
SUGGESTED NEWEL POSTS

<p>Art. 797/6 Ø 25 mm H 1200 mm</p> <p>Art. 797/2 Ø 30 mm H 1200 mm</p>	<p>Art. 112/5 Φ 25 x 25 mm H 1200 mm</p> <p>Art. 112/6 Φ 30 x 30 mm H 1200 mm</p>
-----------------------------------------------------------------------------------------	---------------------------------------------------------------------------------------------------

Paletti Forgiati - Forged Pickets

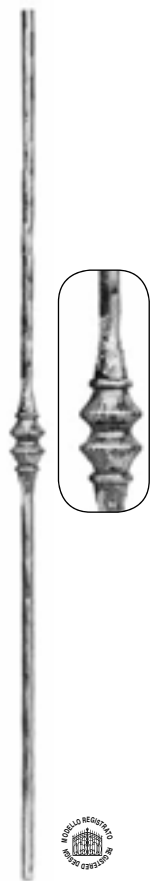

Art. 500/1
 Ø 12 mm
 H 1000 mm

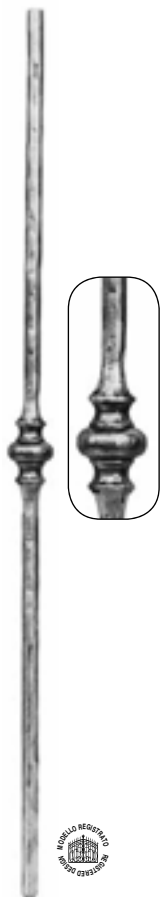

Art. 500/2
 Ø 12 mm
 H 1000 mm

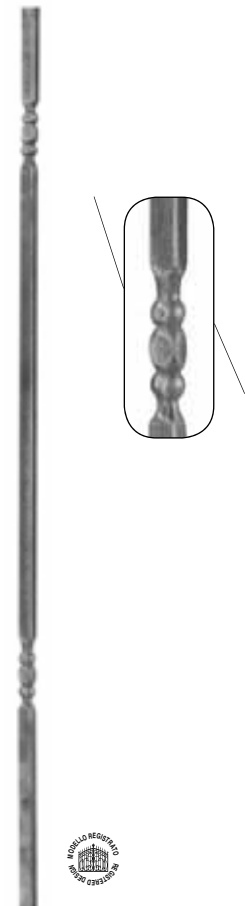

Art. 1773/1
 Ø 14 x 14 mm
 H 1000 mm



Art. 1773/2
 Ø 14 x 14 mm
 H 1000 mm

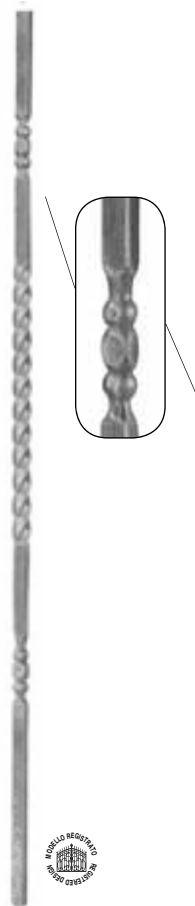

Art. 1773/3
 Ø 14 x 14 mm
 H 1000 mm



Art. 1773/4
 Ø 14 x 14 mm
 H 1000 mm

Art. 1773/5
 Ø 12 x 12 mm
 H 1000 mm

Art. 1773/6
 Ø 12 x 12 mm
 H 1000 mm

Art. 1773/7
 Ø 12 x 12 mm
 H 1000 mm

Art. 1773/8
 Ø 12 x 12 mm
 H 1000 mm

CAPOSALDI CONSIGLIATI
 SUGGESTED NEWEL POSTS

Art. 797/6
 Ø 25 mm
 H 1200 mm

Art. 112/5
 Ø 25 x 25 mm
 H 1200 mm

Art. 797/2
 Ø 30 mm
 H 1200 mm

Art. 112/6
 Ø 30 x 30 mm
 H 1200 mm

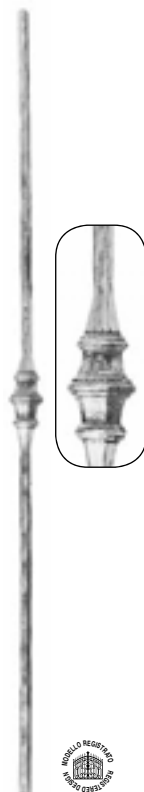

Art. 501/2
 Ø 12 mm
 H 1000 mm

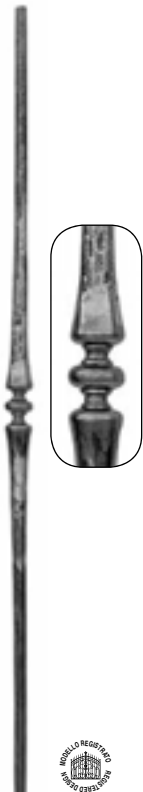

Art. 1185/2
 H 1000 mm
 Conico/Conic

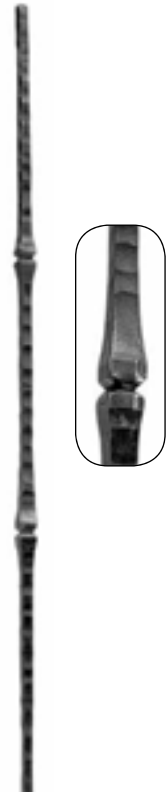

Art. 1192/5
 H 1000 mm
 Conico/Conic



Art. 1192/6
 H 1000 mm
 Conico/Conic

Paletti Forgiati - Forged Pickets



CAPOSALDI CONSIGLIATI
SUGGESTED NEWEL POSTS

Art. 797/5
Ø 25 mm
H 1200 mm
Art. 797/1
Ø 30 mm
H 1200 mm

Art. 798/1
Ø 30 mm
H 1200 mm

Art. 508/3 Ø 14 mm H 1000 mm
 Art. 508/4 Ø 14 mm H 1000 mm
 Art. 1770/1 Ø 12 mm H 1000 mm
 Art. 1771/1 Ø 12 mm H 1000 mm
 Art. 1184/3 Ø 12 mm H 1000 mm

Ø = diameter



CAPOSALDI CONSIGLIATI
SUGGESTED NEWEL POSTS

Art. 112/9
⊠ 30 x 30 mm
H 1200 mm

Art. 110/6 ⊠ 14 x 14 mm H 1000 mm
 Art. 110/3 ⊠ 12 x 12 mm H 1000 mm
 Art. 110/5 ⊠ 12 x 12 mm H 1000 mm
 Art. 110/4 ⊠ 14 x 14 mm H 1000 mm
 Art. 108/A/2 ⊠ 12 x 12 mm H 1000 mm
 Art. 108/A/1 ⊠ 12 x 12 mm H 1000 mm

Paletti Forgiati - Forged Pickets

Borchie in vetro di Murano
Murano Glass Bushing



Ø 55 mm

Ø 55 mm

Ø 55 mm

Ø 55 mm

Ø 40 mm



Art. 1215/1
Ø 14 mm
H 1000 mm

Art. 1215/2
Ø 14 mm
H 1000 mm

Art. 1215/3
Ø 14 mm
H 1000 mm

Art. 1215/4
Ø 14 mm
H 1000 mm

Art. 1218/2
Ø 14 mm
H 1000 mm

Ø = diameter

CAPOSALDI CONSIGLIATI SUGGESTED NEWEL POSTS

Borchia in Legno - Wooden bush



Art. 807/1
Ø 30 mm
H 1200 mm

Art. 807/2
Ø 30 mm
H 1200 mm

Art. 807/3
Ø 30 mm
H 1200 mm

Art. 807/4
Ø 30 mm
H 1200 mm



Borchia in Legno
Wood bush



Art. 523/1
Ø 12 mm
H 900 mm



Borchia in Legno
Wood bush



Art. 523/2
Ø 12 mm
H 900 mm



Borchia in Legno
Wood bush



Art. 523/3
Ø 12 x 12 mm
H 900 mm



Borchia in Legno
Wood bush



Art. 523/4
Ø 12 x 12 mm
H 900 mm

Paletti Forgiati - Forged Pickets

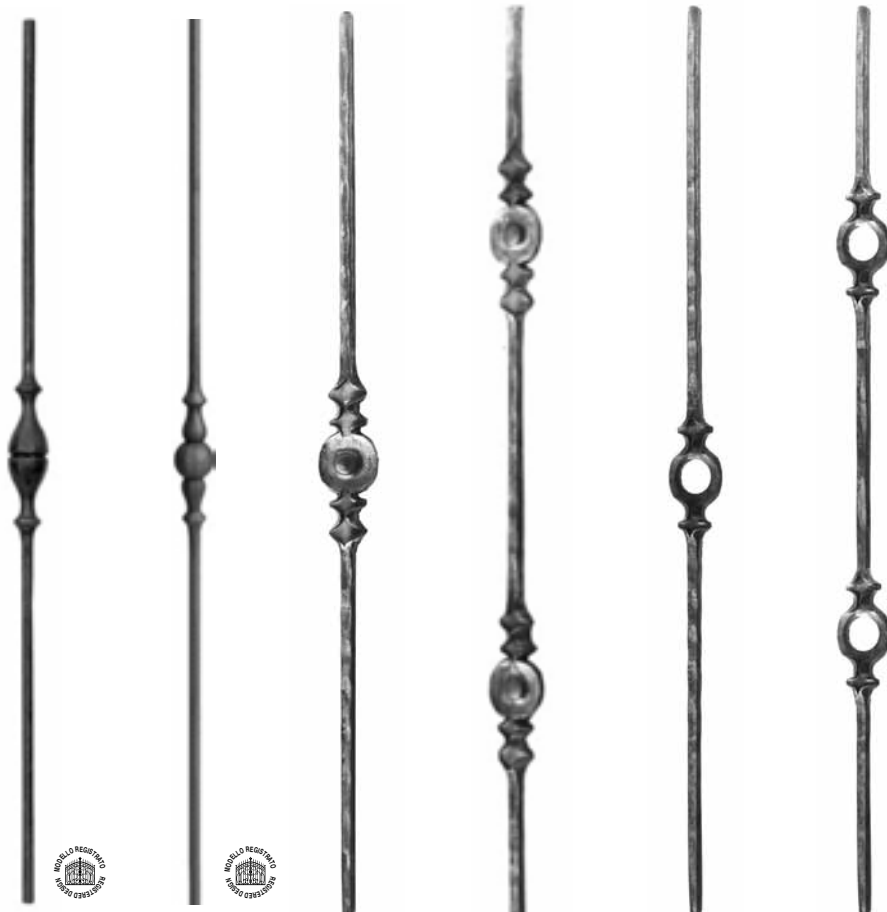

Art. 1185/3 Art. 503/1 Art. 104/3 Art. 104/4 Art. 104/5 Art. 104/6
 Ø 12 mm Ø 12 mm H 1000 mm H 1000 mm H 1000 mm H 1000 mm
 H 1000 mm H 1000 mm

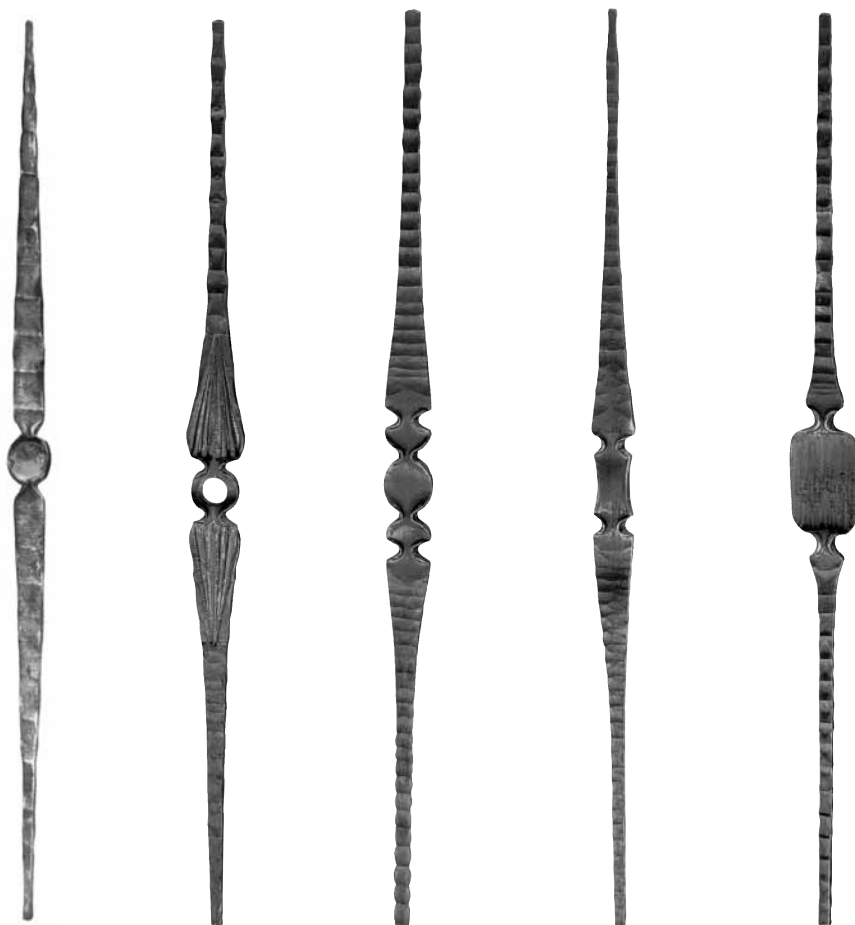

Art. 96/2 Art. 1192/1 Art. 1192/2 Art. 1192/3 Art. 1192/4
 Ø 12 x 12 mm Ø 12 x 8 mm Ø 16 x 8 mm Ø 12 x 10 mm Ø 12 x 10 mm
 H 830 mm H 1000 mm H 1000 mm H 1000 mm H 1000 mm



ARTEFERRO



ARTEFERRO

Paletti Forgiati - Forged Pickets

CAPOSALDI
CONSIGLIATI
SUGGESTED
NEWEL POSTS



Art. 799/1
Ø 25 x 25 mm
H 1100 mm



Art. 505/3
Ø 14 x 14 mm
H 1000 mm



Art. 505/4
Ø 14 x 14 mm
H 1000 mm

CAPOSALDI
CONSIGLIATI
SUGGESTED
NEWEL POSTS



Art. 797/3
Ø 30 mm
H 1200 mm



Art. 503/2
Ø 12 mm
H 1000 mm



Art. 501/1
Ø 12 mm
H 1000 mm



Art. 501/3
Ø 12 mm
H 1000 mm



Art. 1770/7
Ø 14 x 14 mm
H 1000 mm



Art. 1771/7
Ø 14 x 14 mm
H 1000 mm



Art. 508/1
Ø 12 mm
H 1000 mm



Art. 111/2
Ø 39 mm
H 1000 mm

Borchia
in
ottone
Brass
bush
160/B/7

Paletti Forgiati - Forged Pickets

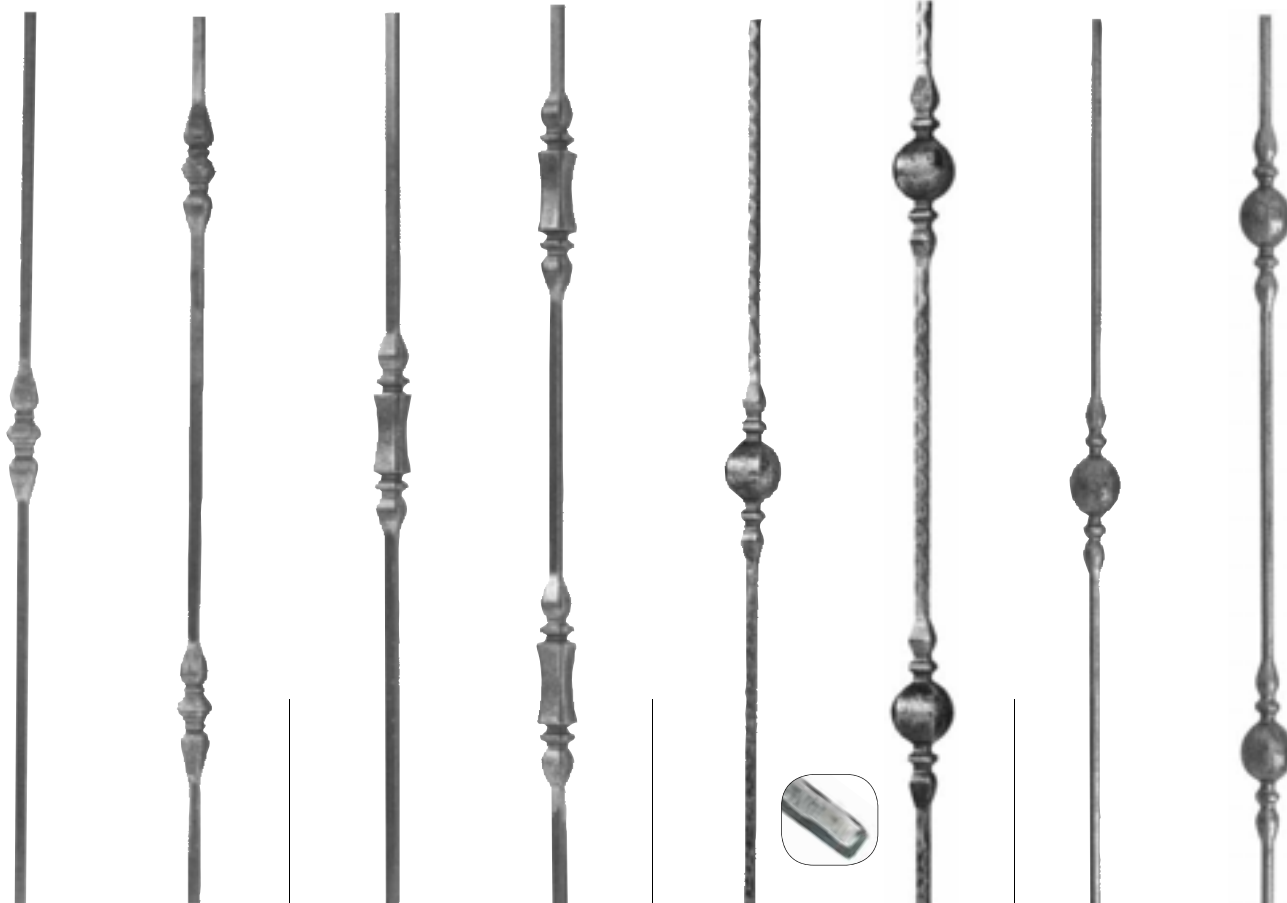

Art. 1191/1 Φ 12 x 12 mm H 900 mm	Art. 1191/2 Φ 12 x 12 mm H 900 mm	Art. 1191/3 Φ 12 x 12 mm H 900 mm	Art. 1191/4 Φ 12 x 12 mm H 900 mm	Art. 1190/3 Φ 12 x 12 mm H 900 mm	Art. 1190/4 Φ 12 x 12 mm H 900 mm	Art. 1190/1 Ø 12 mm H 900 mm	Art. 1190/2 Ø 12 mm H 900 mm
------------------------------------------------	------------------------------------------------	------------------------------------------------	------------------------------------------------	------------------------------------------------	------------------------------------------------	-------------------------------------------	-------------------------------------------

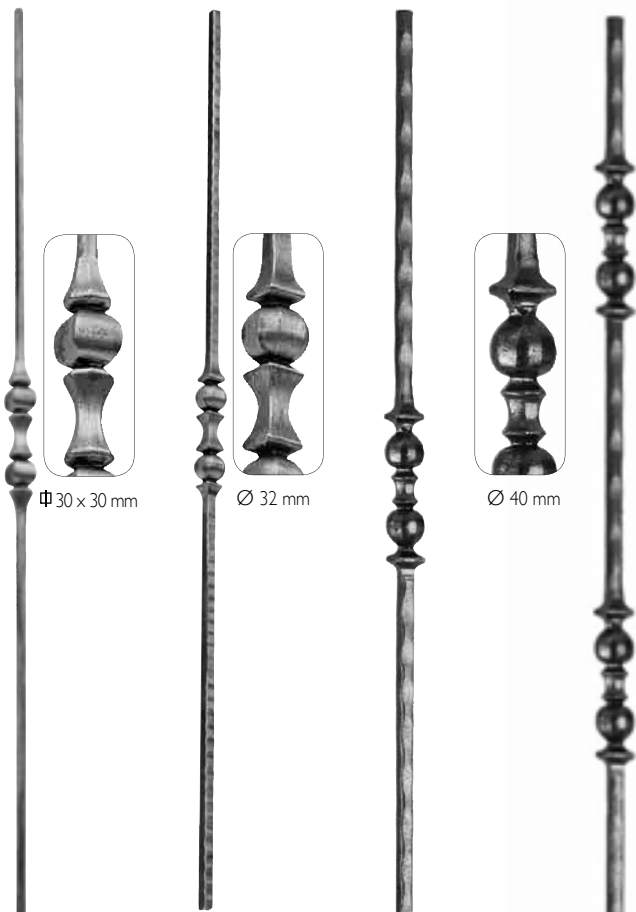

Art. 1769/3 Ø 12 mm H 1000 mm	Art. 1769/4 Φ 12 x 12 mm H 1000 mm	Art. 1770/5 Φ 14 x 14 mm H 1000 mm	Art. 1771/5 Φ 14 x 14 mm H 1000 mm
--------------------------------------------	-------------------------------------------------	-------------------------------------------------	-------------------------------------------------

CAPOSALDI CONSIGLIATI SUGGESTED NEWEL POSTS Borchia forgiata saldata al paletto Forged bush welded to the picket



Art. 1199/1 Φ 25 x 25 mm H 1200 mm	Art. 1199/2 Φ 25 x 25 mm H 1200 mm	Art. 1199/3 Ø 26 mm H 1200 mm	Art. 1199/4 Φ 25 x 25 mm H 1200 mm
			Art. 1199/5 Φ 30 x 30 mm H 1200 mm

Paletti Forgiati - Forged Pickets



ARTEFERRO

Borchia in vetro di Murano
Murano Glass Bushing



Art. 1218/1
Ø 14 mm
H 1000 mm



Art. 1184/1
Ø 14 mm
H 1000 mm



Art. 1184/2
Ø 14 mm
H 1000 mm

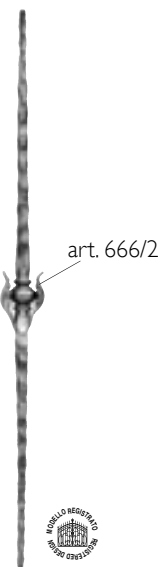

Art. 493/2
H 1000 mm

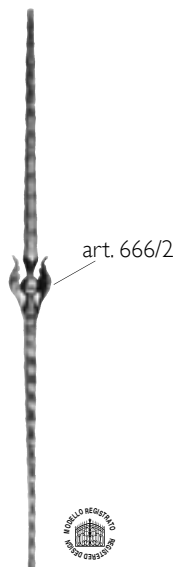

Art. 493/1
H 1000 mm



Art. 505/1
Ø 14 x 14 mm
H 1000 mm



Art. 505/2
Ø 14 x 14 mm
H 1000 mm



Art. 492/2
H 1000 mm



Art. 492/1
H 1000 mm

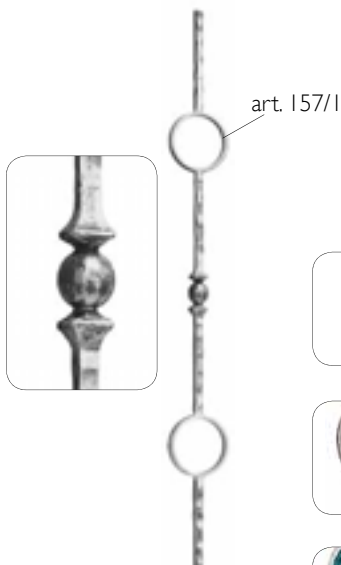

Art. 512/2
H 900 mm
L 100 mm



Medaglie in ottone
Brass embellishments
Art. 513/2



Medaglie in legno
Wood embellishments
Art. 515/4



Medaglie in vetro
Glass embellishments
Art. 516/2



art. 157/1



Medaglie in ottone
Brass embellishments
Art. 513/1



Medaglie in legno
Wood embellishments
Art. 515/3



Art. 512/1
H 900 mm
L 100 mm

Medaglie in vetro
Glass embellishments
Art. 516/1



Art. 489/2 Art. 489/1 Art. 490/1 Art. 490/2 Art. 507/1 Art. 507/2 Art. 101/2 Art. 101/1
 Ø 12 x 12 mm Ø 12 x 12 mm Ø 12 x 12 mm Ø 12 x 12 mm Ø 14 x 14 mm Ø 14 x 14 mm H 1000 mm Ø 14 x 14 mm
 H 1000 mm H 1000 mm H 1000 mm H 1000 mm H 1000 mm H 1000 mm H 1000 mm H 1000 mm

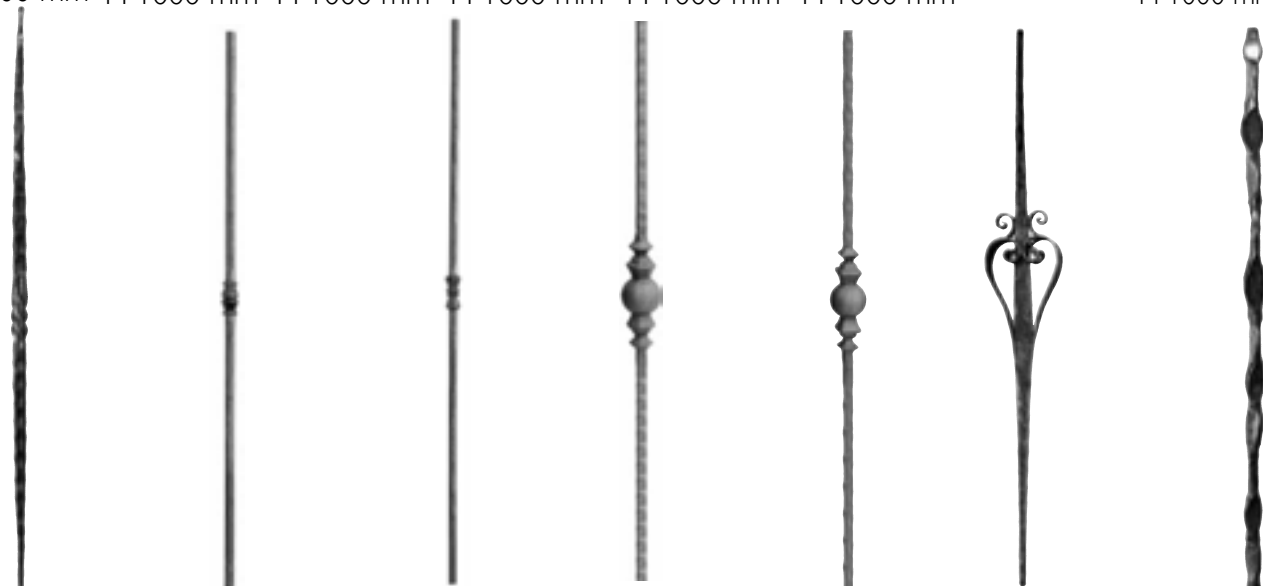

Art. 96/1 Art. 1192/8 Art. 1192/9 Art. 502/1 Art. 502/2 Art. 96/3 Art. 96/4
 Ø 20 x 8 mm Ø 14 mm Ø 12 mm Ø 14 x 14 mm Ø 14 x 14 mm Ø 16 x 8 mm Ø 16 x 8 mm
 H 830 mm H 1000 mm H 1000 mm H 1000 mm H 900 mm H 830 mm H 830 mm

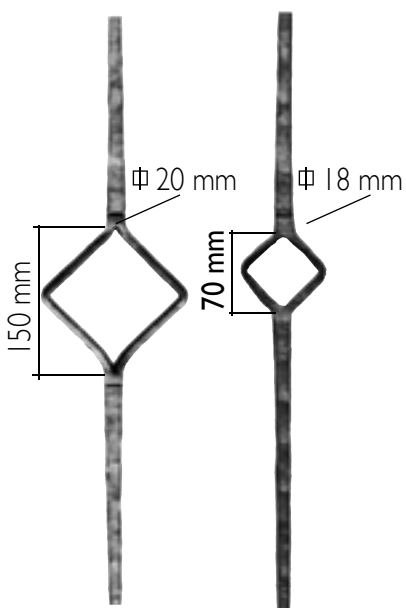

Art. 108/2 Art. 108/1
 H 1000 mm H 1000 mm

Foro Filettato Forged Threaded hole Ø 8 MA
 Foro Filettato Forged Threaded hole Ø 8 MA
 Foro Filettato Forged Threaded hole Ø 8 MA
 Foro Filettato Forged Threaded hole Ø 8 MA



Art. 1198/4 Art. 1198/5 Art. 1198/6 Art. 1198/3
 Ø 12 x 12 mm Ø 12 mm Ø 12 x 12 mm Ø 14 mm
 H 450 mm H 450 mm H 450 mm H 450 mm



Art. 102/1
 H 900 mm

CAPOSALDI
 CONSIGLIATI
 SUGGESTED
 NEWEL POSTS

Art. 112/1
 Ø 25 x 25 mm
 H 1200 mm
 Art. 112/2
 Ø 30 x 30 mm
 H 1200 mm



Art. 496/B/1 \varnothing 13 x 13 mm H 1000 mm
Art. 496/B/2 \varnothing 13 x 13 mm H 1000 mm
Art. 496/B/3 \varnothing 13 x 13 mm H 1000 mm
Art. 496/B/4 \varnothing 13 x 13 mm H 1000 mm
Art. 496/B/5 \varnothing 13 x 13 mm H 1000 mm
Art. 106/2 \varnothing 12 x 12 mm H 1000 mm

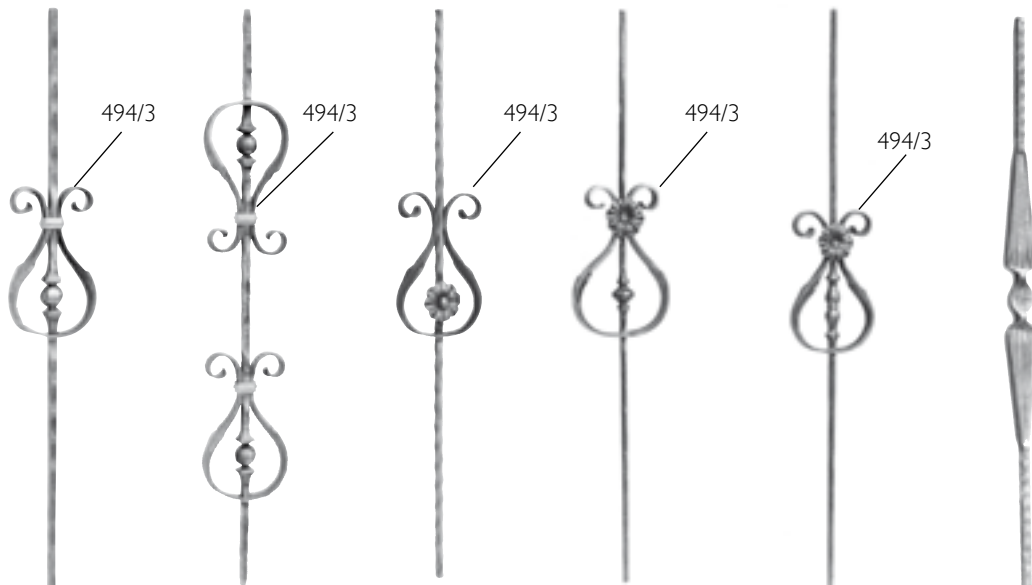

Art. 494/1 H 1000 mm L 140 mm
Art. 494/2 H 1000 mm L 140 mm
Art. 496/1 H 1000 mm L 140 mm
Art. 496/2 H 1000 mm L 140 mm
Art. 496/3 H 1000 mm L 140 mm
Art. 100/3 \varnothing 14 x 14 mm H 1000 mm



Art. 487/1 \varnothing 16 x 8 mm H 900 mm L 230 mm
Art. 488/1 \varnothing 16 x 8 mm H 900 mm L 190 mm
Art. 509/1 H 900 mm
Art. 515/6 H 900 mm L 245 mm



Art. 514/1
medaglia in ottone
brass embellishment

Art. 515/5
medaglia in legno
wood embellishment

Art. 516/3
medaglia in vetro
glass embellishment

CAPOSALDI CONSIGLIATI
SUGGESTED NEWEL POSTS

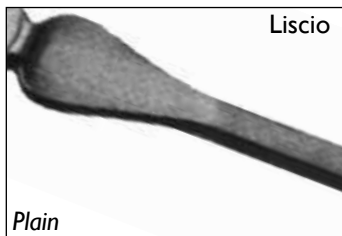
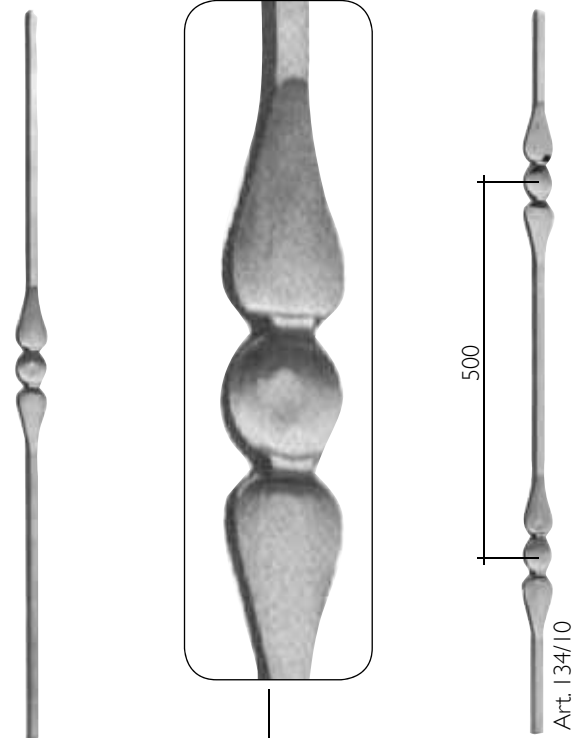
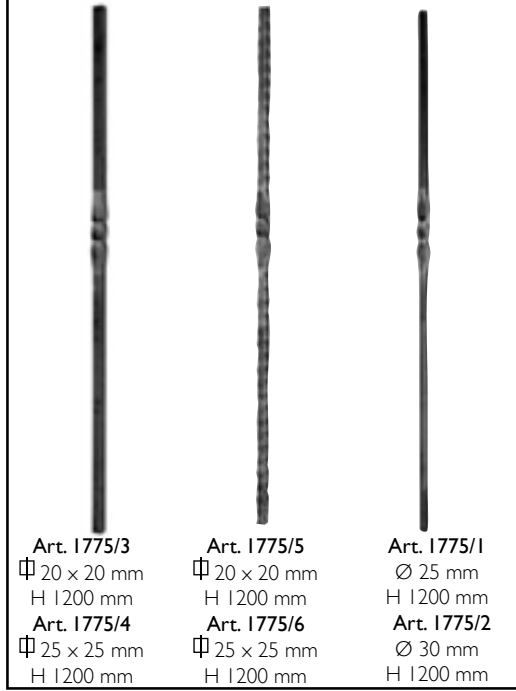

	Cod.art. Art.no.	Cod.art. Art.no.	Cod.art. Art.no.	Cod.art. Art.no.	Cod.art. Art.no.	Cod.art. Art.no.	Cod.art. Art.no.	Cod.art. Art.no.
Sez./ Sect.	H 1200 mm	H 1000 mm	H 900 mm	H 830 mm	H 1200 mm	H 1000 mm	H 900 mm	H 830 mm
Φ 12 x 12 mm	-	134/2	-	134/1	-	134/10	-	134/9
Φ 14 x 14 mm	-	134/4	-	134/3	-	134/12	-	134/11
⊠ 12 x 6 mm	134/A/2	-	134/A/1	-	134/A/4	-	134/A/3	-
Ø 12 mm	-	1251/9	-	-	-	1251/10	-	-
Ø 14 mm	-	1251/11	-	-	-	1251/12	-	-

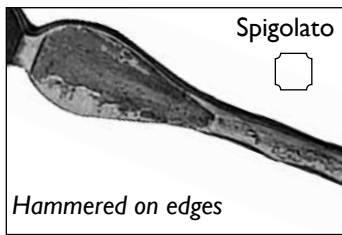

	Cod.art. Art.no.	Cod.art. Art.no.	Cod.art. Art.no.	Cod.art. Art.no.	Cod.art. Art.no.	Cod.art. Art.no.	Cod.art. Art.no.	Cod.art. Art.no.
Sez./ Sect.	H 1200 mm	H 1000 mm	H 900 mm	H 830 mm	H 1200 mm	H 1000 mm	H 900 mm	H 830 mm
Φ 12 x 12 mm	-	587/42	-	587/41	-	587/46	-	587/45
Φ 14 x 14 mm	-	587/44	-	587/43	-	587/48	-	587/47
-	-	-	-	-	-	-	-	-
-	-	-	-	-	-	-	-	-
-	-	-	-	-	-	-	-	-

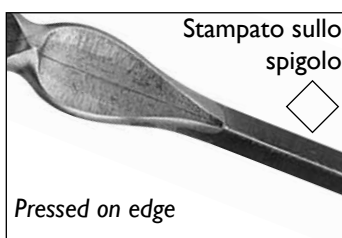

	Cod.art. Art.no.	Cod.art. Art.no.	Cod.art. Art.no.	Cod.art. Art.no.	Cod.art. Art.no.	Cod.art. Art.no.	Cod.art. Art.no.	Cod.art. Art.no.
Sez./ Sect.	H 1200 mm	H 1000 mm	H 900 mm	H 830 mm	H 1200 mm	H 1000 mm	H 900 mm	H 830 mm
Φ 12 x 12 mm	-	1749/11	-	-	-	1749/9	-	-
Φ 14 x 14 mm	-	1749/12	-	-	-	1749/10	-	-
-	-	-	-	-	-	-	-	-
-	-	-	-	-	-	-	-	-
-	-	-	-	-	-	-	-	-

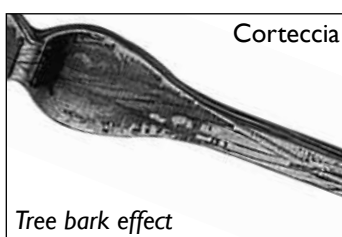

	Cod.art. Art.no.	Cod.art. Art.no.	Cod.art. Art.no.	Cod.art. Art.no.	Cod.art. Art.no.	Cod.art. Art.no.	Cod.art. Art.no.	Cod.art. Art.no.
Sez./ Sect.	H 1200 mm	H 1000 mm	H 900 mm	H 830 mm	H 1200 mm	H 1000 mm	H 900 mm	H 830 mm
Φ 12 x 12 mm	-	1251/1	-	-	-	1251/2	-	-
Φ 14 x 14 mm	-	1251/3	-	-	-	1251/4	-	-
-	-	-	-	-	-	-	-	-
-	-	-	-	-	-	-	-	-
-	-	-	-	-	-	-	-	-

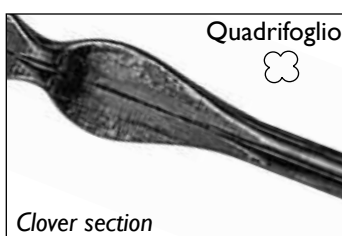

	Cod.art. Art.no.	Cod.art. Art.no.	Cod.art. Art.no.	Cod.art. Art.no.	Cod.art. Art.no.	Cod.art. Art.no.	Cod.art. Art.no.	Cod.art. Art.no.
Sez./ Sect.	H 1200 mm	H 1000 mm	H 900 mm	H 830 mm	H 1200 mm	H 1000 mm	H 900 mm	H 830 mm
Φ 12 x 12 mm	-	1251/5	-	-	-	1251/6	-	-
Φ 14 x 14 mm	-	1251/7	-	-	-	1251/8	-	-
-	-	-	-	-	-	-	-	-
-	-	-	-	-	-	-	-	-
-	-	-	-	-	-	-	-	-



Art. 134/5

Φ 12 x 12 mm
H 830 mm

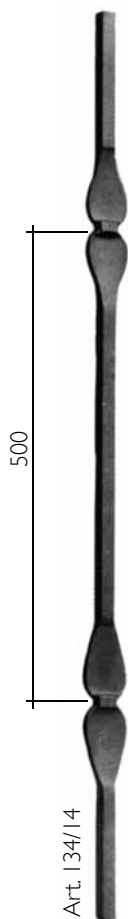

500

Art. 134/14

Art. 134/13

Φ 12 x 12 mm
H 830 mm



Art. 1749/1

Φ 12 x 12 mm
H 1000 mm



Art. 1749/3

Φ 12 x 12 mm
H 1000 mm



Art. 134/A/5

∇ 12 x 6 mm
H 900 mm



Art. 134/A/7

∇ 12 x 6 mm
H 900 mm



Art. 134/A/9

∇ 12 x 6 mm
H 900 mm

Art. 134/7

Φ 14 x 14 mm
H 830 mm

Art. 134/15

Φ 14 x 14 mm
H 830 mm

Art. 1749/2

Φ 14 x 14 mm
H 1000 mm

Art. 1749/4

Φ 14 x 14 mm
H 1000 mm

Art. 134/A/6

∇ 12 x 6 mm
H 1200 mm

Art. 134/A/8

∇ 12 x 6 mm
H 1200 mm

Art. 134/A/10

∇ 12 x 6 mm
H 1200 mm

Art. 134/6

Φ 12 x 12 mm
H 1000 mm

Art. 134/14

Φ 12 x 12 mm
H 1000 mm

Art. 64/L/4

Ø 14 mm
H 900 mm

Art. 64/L/3

Ø 14 mm
H 900 mm

Art. 134/8

Φ 14 x 14 mm
H 1000 mm

Art. 134/16

Φ 14 x 14 mm
H 1000 mm



Art. 586/4

Φ 8 x 8 mm
H 900 mm



Art. 586/5

Φ 8 x 8 mm
H 900 mm



Art. 64/L/1

Φ 14 x 14 mm
H 900 mm



Art. 64/L/2

Φ 14 x 14 mm
H 900 mm



ARTEFERRO

CAPOSALDI
CONSIGLIATI
SUGGESTED
NEWEL POSTS



Art. 1775/10
Φ 20 x 20 mm
Art. 1775/11
Φ 25 x 25 mm
Art. 1775/12
Φ 30 x 30 mm



ARTEFERRO

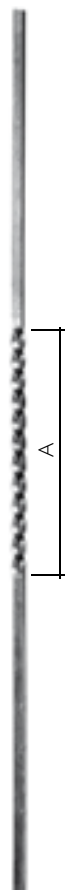

H 1000 mm



H 1000 mm



H 1000 mm

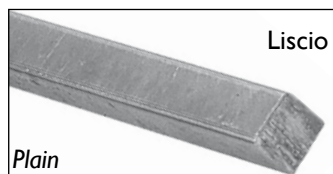

Liscio

Plain

Sez. / Sect.	Cod.art./Art.no.	A	Cod.art./Art.no.	B	Cod.art./Art.no.	C
Φ 10 × 10 mm	1148/4	280 mm	1148/7	180 mm	1148/1	660 mm
Φ 12 × 12 mm	1148/5	280 mm	1148/8	180 mm	1148/2	660 mm
Φ 14 × 14 mm	1148/6	280 mm	1148/9	180 mm	1148/3	660 mm
∟ 14 × 8 mm	1148/20	280 mm	1148/21	180 mm	1148/19	660 mm



Corteccia

Tree bark effect

Φ 10 × 10 mm	1148/13	180 mm	1148/16	180 mm	1148/10	660 mm
Φ 12 × 12 mm	1148/14	180 mm	1148/17	180 mm	1148/11	660 mm
Φ 14 × 14 mm	1148/15	280 mm	1148/18	180 mm	1148/12	660 mm
∟ 14 × 8 mm	-	-	-	-	-	-

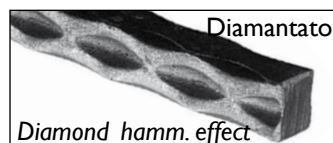

Diamantato

Diamond hamm. effect

Φ 10 × 10 mm	-	-	-	-	-	-
Φ 12 × 12 mm	-	-	-	-	-	-
Φ 14 × 14 mm	-	-	-	-	-	-
∟ 14 × 8 mm	1148/23	280 mm	1148/24	180 mm	1148/22	660 mm

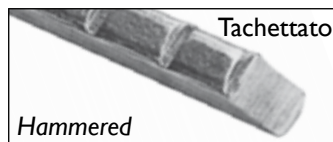

Tachettato

Hammered

Φ 10 × 10 mm	-	-	-	-	-	-
Φ 12 × 12 mm	-	-	-	-	-	-
Φ 14 × 14 mm	-	-	-	-	-	-
∟ 14 × 8 mm	1148/26	280 mm	1148/27	180 mm	1148/25	660 mm

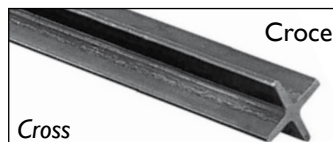

Croce

Cross

-	-	-	-	-	-	-
-	-	-	-	-	-	-
40 × 40 × 3,5 mm	1148/30	280 mm	1148/32 (no attorc. - no twist)	-	1148/28	840 mm
50 × 50 × 5 mm	1148/31	280 mm	1148/33 (no attorc. - no twist)	-	1148/29	840 mm

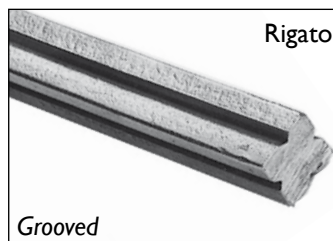

Rigato

Grooved

Φ 8 × 8 mm	-	-	-	-	1723/1	800 mm
Φ 10 × 10 mm	-	-	-	-	1151/2	660 mm
Φ 12 × 12 mm	1151/5	300 mm	1151/6	200 mm	1151/7	660 mm
Φ 14 × 14 mm	-	-	-	-	1723/4	800 mm
Φ 16 × 16 mm	-	-	-	-	1723/5	800 mm
Φ 18 × 18 mm	-	-	-	-	1723/6	800 mm
Φ 20 × 20 mm	-	-	-	-	1723/7	800 mm

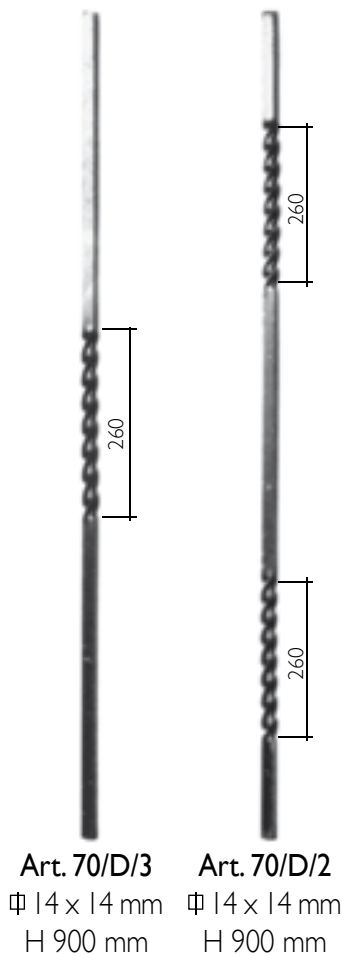

	Cod.art./Art.no.	Cod.art./Art.no.	Cod.art./Art.no.	Cod.art./Art.no.	Cod.art./Art.no.
Sez. / Sect.	H 720 mm A = 520 mm	H 820 mm A = 620 mm	H 900 mm A = 700 mm	H 1000 mm	H 1200 mm A = 900 mm
16 x 4 mm	119/4	119/11	119/18	-	-
20 x 4 mm	119/5	119/12	119/19	-	-
20 x 6 mm	119/6	119/13	119/20	-	-
30 x 8 mm	-	-	118/H/3	-	118/H/4



	Cod.art./Art.no.	Cod.art./Art.no.	Cod.art./Art.no.	Cod.art./Art.no.	Cod.art./Art.no.
Sez. / Sect.	H 720 mm A = 520 mm	H 820 mm A = 620 mm	H 900 mm A = 700 mm	H 1000 mm	H 1200 mm A = 900 mm
8 x 8 mm	119/7	119/14	119/21	-	-
10 x 10 mm	119/8	119/15	119/22	-	-
12 x 12 mm	119/9	119/16	119/23	-	-
14 x 14 mm	119/10	119/17	119/24	-	-
20 x 20 mm	-	-	-	119/25	-
25 x 25 mm	-	-	-	119/26	-
30 x 30 mm	-	-	-	119/27	-
40 x 40 mm	-	-	-	119/28	-

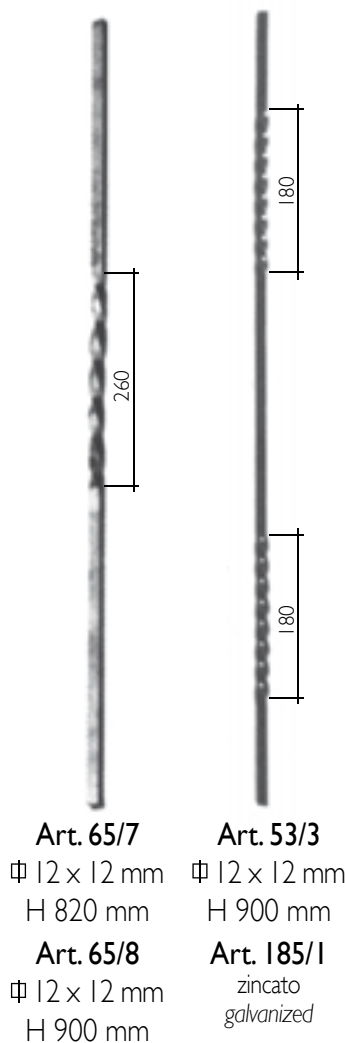

La maggior parte degli articoli di questo catalogo possono essere prodotti anche con misure diverse
 Most wrought iron design show in this catalogue can be produced with special dimension

TORCIGLIONI CON DOPPIA ATTORCIGLIATURA DOUBLE TWIST PICKETS

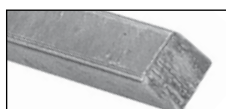

Cod.art./Art.no.	Cod.art./Art.no.	Cod.art./Art.no.	Cod.art./Art.no.
Sez. / Sect.	H 900 mm	H 1000 mm	H 1200 mm
12 x 12 mm	GD106/1	GD106/4	GD106/7
14 x 14 mm	GD106/2	GD106/5	GD106/8
16 x 16 mm	GD106/3	GD106/6	GD106/9

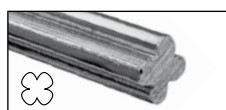

12 x 12 mm	GD106/10	GD106/13	GD106/16
14 x 14 mm	GD106/11	GD106/14	GD106/17
16 x 16 mm	GD106/12	GD106/15	GD106/18

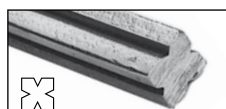

12 x 12 mm	GD106/19	GD106/22	GD106/25
14 x 14 mm	GD106/20	GD106/23	GD106/26
16 x 16 mm	GD106/21	GD106/24	GD106/27

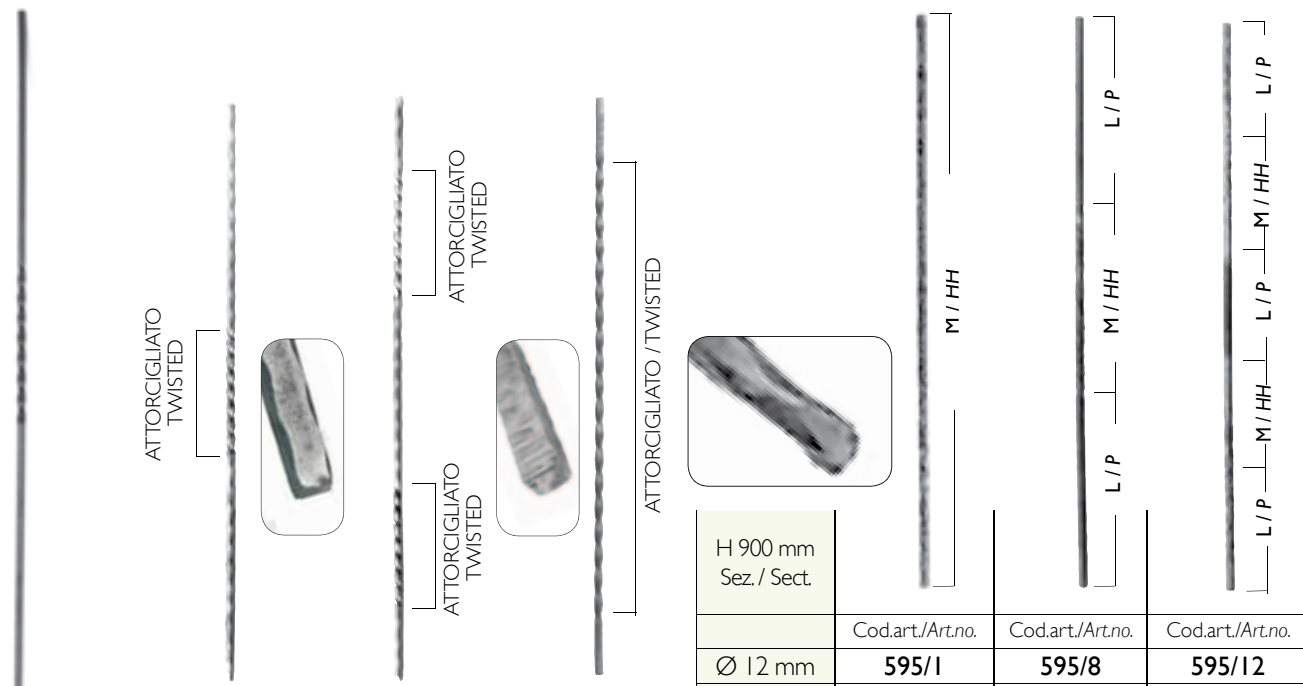

Art. 49/8 Φ 12 x 12 mm H 1300 mm
Art. 118/B/2 Φ 12 x 12 mm H 900 mm
Art. 118/B/3 Φ 12 x 12 mm H 900 mm
Art. 118/B/4 Φ 12 x 12 mm H 900 mm

Art. 49/9
 Φ 14 x 14 mm
 H 1300 mm

H 900 mm Sez. / Sect.	Cod.art./Art.no.	Cod.art./Art.no.	Cod.art./Art.no.
Φ 12 mm	595/1	595/8	595/12
Φ 14 mm	595/2	595/9	595/13
Φ 16 mm	595/3	595/10	595/14
Φ 18 mm	595/4	595/11	595/15

M / HH = MAGLIATO / HAND HAMMERED
 L / P = LISCIO / PLAIN



ARTEFERRO

CAPOSALDI CONSIGLIATI VEDI PAGINA 224-225
 SUGGESTED NEWEL POSTS ON PAGES 224-225

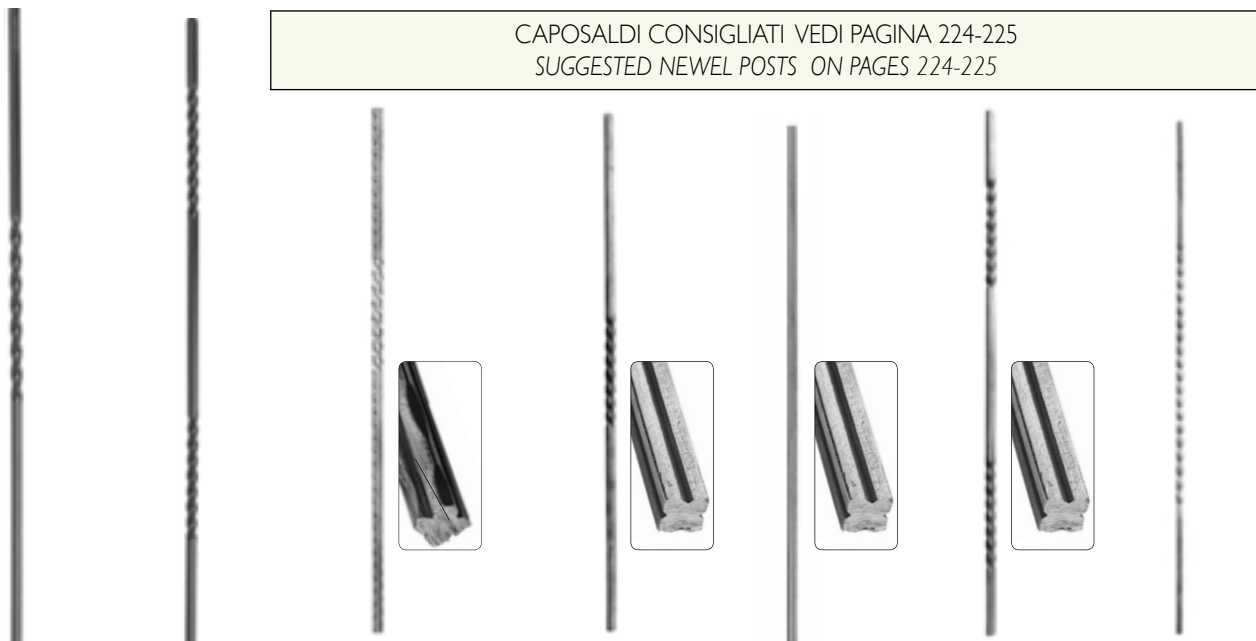

Art. 1160/7 Φ 12 x 12 mm H 1200 mm
Art. 1160/8 Φ 12 x 12 mm H 1200 mm
Art. 639/5 Φ 20 x 20 mm H 1200 mm
Art. 639/6 Φ 12 x 12 mm H 900 mm
Art. 118/H/2 Φ 12 x 12 mm H 900 mm
Art. 118/H/30 Φ 12 x 12 mm H 1000 mm
Art. GD35/4 Φ 12 x 12 mm H 1000 mm
Art. 118/H/1 Φ 12 x 12 mm H 900 mm
Art. 118/H/29 Φ 12 x 12 mm H 1000 mm
Art. 55/3 Φ 8 x 8 mm H 820 mm
Art. 55/4 Φ 8 x 8 mm H 900 mm

CAPOSALDI CONSIGLIATI
VEDI PAGINA 224-225
SUGGESTED NEWEL POSTS
ON PAGES 224-225



H 1000 mm

Sez. / Sect.	Cod.art./Art.no.	Cod.art./Art.no.
Φ 12 x 12 mm	1133/25	1133/29
Φ 14 x 14 mm	1333/26	1133/30
Ø 12 mm	1333/27	1133/31
Ø 14 mm	1333/28	1133/32



Sez. / Sect.	H 900 mm	H 1000 mm	H 2000 mm
	Cod.art./Art.no.	Cod.art./Art.no.	Cod.art./Art.no.
Ø 10 mm	601/1	601/7	601/13
Ø 12 mm	601/2	601/8	601/14
Ø 14 mm	601/3	601/9	601/15
Ø 16 mm	601/4	601/10	601/16
Ø 18 mm	601/5	601/11	601/17
Ø 20 mm	601/6	601/12	601/18



Sez. / Sect.	H 900 mm	H 1000 mm	H 2000 mm
	Cod.art./Art.no.	Cod.art./Art.no.	Cod.art./Art.no.
Ø 10 mm	602/1	602/7	602/13
Ø 12 mm	602/2	602/8	602/14
Ø 14 mm	602/3	602/9	602/15
Ø 16 mm	602/4	602/10	602/16
Ø 18 mm	602/5	602/11	602/17
Ø 20 mm	602/6	602/12	602/18

● Battuto meccanicamente / Mechanically hammered bar



Sez. / Sect.	H 900 mm	H 1000 mm
	Cod.art./Art.no.	Cod.art./Art.no.
Φ 12 x 12 mm	-	GD64/2
Φ 14 x 14 mm	70/D/1	GD64/1
Φ 25 x 25 mm	-	GD64/4
Ø 14 mm	-	GD64/3



∇ 20 x 6 mm	-	1132/1
∇ 20 x 8 mm	-	1132/2
∇ 30 x 6 mm	-	1132/3



Φ 12 x 12 mm	597/1	597/2	H 1200 mm
Φ 14 x 14 mm	597/3	597/4	H 1200 mm

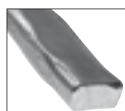

∇ 12 x 6 mm	-	1132/4
∇ 14 x 8 mm	-	1132/5
∇ 16 x 8 mm	-	1132/6



∞ 10 x 10 mm	-	1132/7
∞ 12 x 12 mm	-	1132/8
∞ 14 x 14 mm	-	1132/9



Art. 1160/9
Φ 12 x 12 mm
H 1200 mm
Art. 1160/10
Φ 14 x 14 mm
H 1200 mm



Art. 1160/11
Ø 12 mm
H 1200 mm
Art. 1160/12
Ø 16 mm
H 1200 mm



Art. 134/G/3
Φ 12 x 12 mm
H 900 mm



Art. 134/G/4
Φ 12 x 12 mm
H 900 mm



Art. 118/B/1
Φ 12 x 12 mm
H 900 mm



Art. 118/B/5
Φ 12 x 12 mm
H 900 mm



Art. 1157/1
Φ 14 x 14 mm
H 1200 mm



Art. 1167/3
 Ø 12 mm
 H 1000 mm



Art. 1167/4
 Ø 12 mm
 H 1000 mm



Art. 1167/1
 Ø 12 mm
 H 1000 mm



Art. 1167/2
 Ø 12 mm
 H 1000 mm



Sfere Ø 40 mm - Sphere 40 mm dia.

Art. 1166/3
 Ø 12 mm
 H 900 mm



Sfere Ø 40 mm - Sphere 40 mm dia.

Art. 1166/4
 Ø 12 mm
 H 900 mm



Sfere Ø 40 mm - Sphere 40 mm dia.

Art. 1166/1
 Ø 12 mm
 H 900 mm

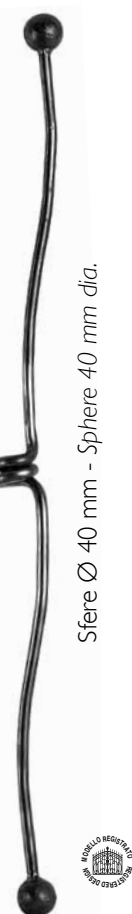

Sfere Ø 40 mm - Sphere 40 mm dia.

Art. 1166/2
 Ø 12 mm
 H 900 mm



ARTEFERRO

CAPOSALDI CONSIGLIATI
SUGGESTED NEWEL POSTS



Art. 112/B/9
Φ 20 x 20 mm
H 1100 mm
Art. 112/B/10
Φ 30 x 30 mm
H 1100 mm

Art. 112/B/11
Φ 20 x 20 mm
H 1100 mm
Art. 112/B/12
Φ 30 x 30 mm
H 1100 mm



● zincato / galvanized



Art. 113/3
Φ 20 x 20 mm
H 1100 mm
Art. 113/4
Φ 30 x 30 mm
H 1100 mm

Art. 113/1
Φ 20 x 20 mm
H 1100 mm
Art. 113/2
Φ 30 x 30 mm
H 1100 mm



Art. 1203/2
Φ 24 x 24 mm
H 1200 mm

Art. 1203/1
Φ 24 x 24 mm
H 1200 mm

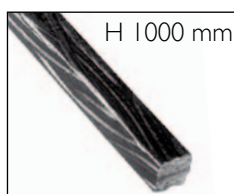
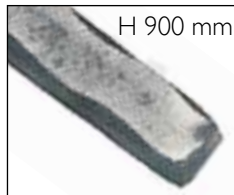
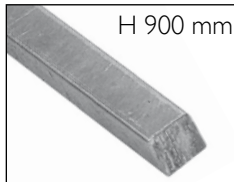

Sez. / Sect.	Cod.art./Art.no.	Cod.art./Art.no.	Cod.art./Art.no.	Cod.art./Art.no.
Φ 12 x 12 mm L 55 mm	48/A/1	48/A/2	48/2	48/1
Φ 14 x 14 mm L 60 mm	48/A/5	48/A/6	48/7	48/6
Φ 16 x 16 mm L 65 mm	48/A/9	48/A/10	48/12	48/11
Φ 12 x 12 mm L 55 mm	48/3	48/4 ● 185/2	-	-
Φ 14 x 14 mm L 60 mm	48/8	48/9	-	-
Φ 16 x 16 mm L 65 mm	48/13	48/14	-	-
Φ 12 x 12 mm L 55 mm	48/A/3	48/A/4	-	-
Φ 14 x 14 mm L 60 mm	48/A/7	48/A/8	-	-
Φ 16 x 16 mm L 65 mm	48/A/11	48/A/12	-	-
Φ 12 x 12 mm L 55 mm	1151/4	1151/3	1151/1	1151/2
Φ 14 x 14 mm L 60 mm	-	-	-	-
Φ 16 x 16 mm L 65 mm	-	-	-	-
Φ 12 x 12 mm L 55 mm	1733/17	1733/18	-	-
Φ 14 x 14 mm L 60 mm	1733/19	1733/20	-	-
Φ 16 x 16 mm L 65 mm	-	-	-	-

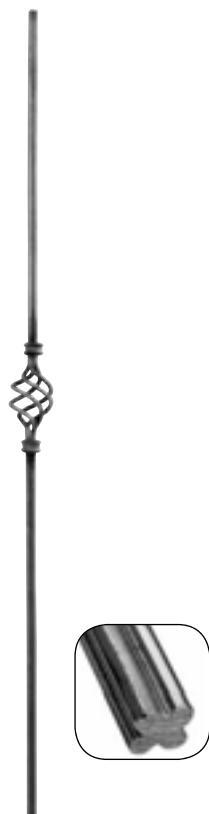

Art. 1150/1
 ☞ 12 x 12 mm
 H 1000 mm



Art. 1150/2
 ☞ 12 x 12 mm
 H 1000 mm



Art. 1150/3
 ☞ 12 x 12 mm
 H 1000 mm



Art. 1150/4
 ☞ 12 x 12 mm
 H 1000 mm

Art. 1150/5
 ☞ 14 x 14 mm
 H 1000 mm

Art. 1150/6
 ☞ 14 x 14 mm
 H 1000 mm

Art. 1150/7
 ☞ 14 x 14 mm
 H 1000 mm

Art. 1150/8
 ☞ 14 x 14 mm
 H 1000 mm



Art. 1152/1
 Ø 12 mm
 H 1000 mm
 L 55 mm



Art. 1152/2
 Ø 12 mm
 H 1000 mm
 L 55 mm



Art. 1152/3
 Ø 12 mm
 H 1000 mm
 L 55 mm



Art. 1152/4
 Ø 12 mm
 H 1000 mm
 L 55 mm



PALETTI A QUADRIFOGLIO
 CON PIGNA A TREFOLI TONDI
 CLOVER-LEAF SHAPE PICKETS AND
 BASKET WITH ROUND FILAMENTS

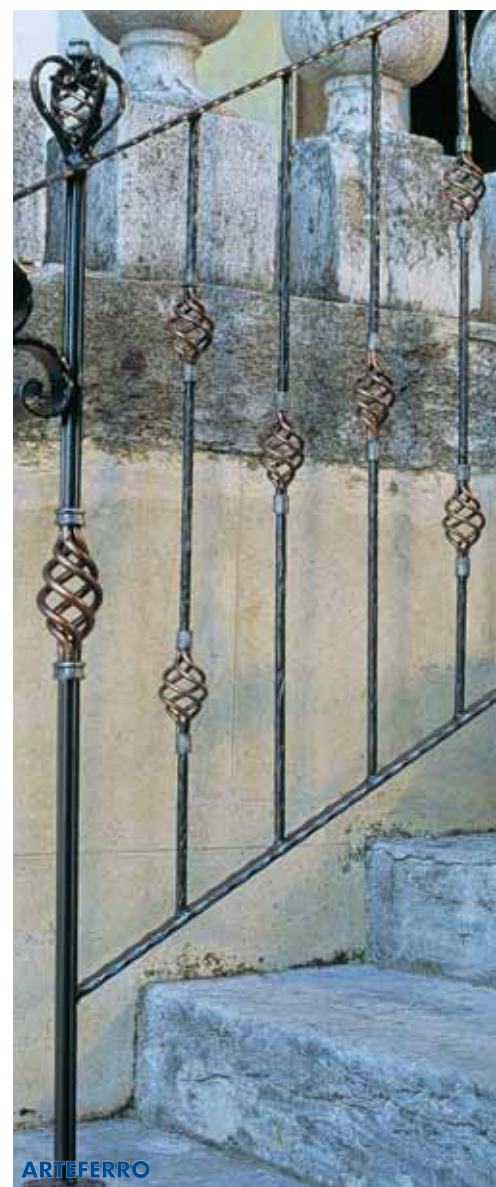

ARTEFERRO



PIGNA A TREFOLI TONDI
 BASKET WITH ROUND FILAMENTS

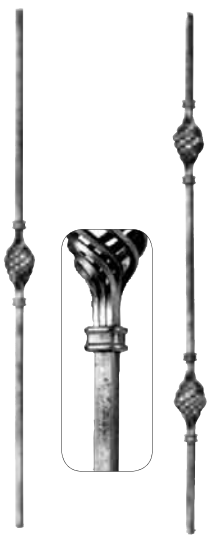

Art. 48/B/6 **Art. 48/B/5**
 Ø 12 x 12 mm Ø 12 x 12 mm
 H 900 mm H 900 mm
 L 55 mm L 55 mm



Art. 48/B/4 **Art. 48/B/3**
 Ø 12 x 12 mm Ø 12 x 12 mm
 H 900 mm H 900 mm
 L 55 mm L 55 mm



Art. 48/B/2 **Art. 48/B/1**
 Ø 12 x 12 mm Ø 12 x 12 mm
 H 900 mm H 900 mm
 L 55 mm L 55 mm



Art. 48/B/8 **Art. 48/B/7**
 Ø 12 x 12 mm Ø 12 x 12 mm
 H 900 mm H 900 mm
 L 55 mm L 55 mm



Art. 462/1 **Art. 462/2**
 Ø 16 mm Ø 16 mm
 H 900 mm H 900 mm
 L 55 mm L 55 mm



Art. 462/3 **Art. 462/4**
 Ø 16 mm Ø 16 mm
 H 900 mm H 900 mm
 L 55 mm L 55 mm



Art. 1149/1 **Art. 1149/2**
 Ø 12 x 12 mm Ø 12 x 12 mm
 H 1000 mm H 1000 mm



Art. 1149/3 **Art. 1149/4**
 Ø 12 x 12 mm Ø 12 x 12 mm
 H 1000 mm H 1000 mm



Art. 1149/5 **Art. 1149/6**
 Ø 12 x 12 mm Ø 12 x 12 mm
 H 1000 mm H 1000 mm

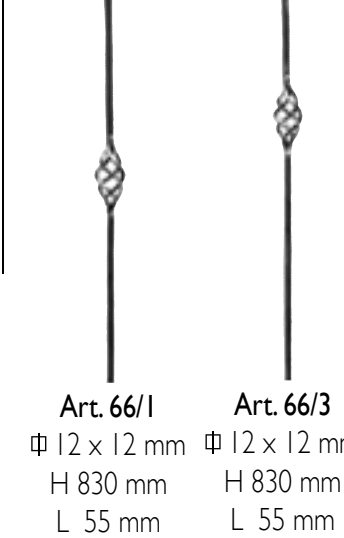

Art. 66/1 **Art. 66/3**
 Ø 12 x 12 mm Ø 12 x 12 mm
 H 830 mm H 830 mm
 L 55 mm L 55 mm



Art. 1158/1 **Art. 1158/2**
 Ø 12 x 12 mm Ø 12 x 12 mm
 H 1200 mm H 1200 mm



Art. 1158/3 **Art. 1158/4**
 Ø 14 x 14 mm Ø 14 x 14 mm
 H 1200 mm H 1200 mm

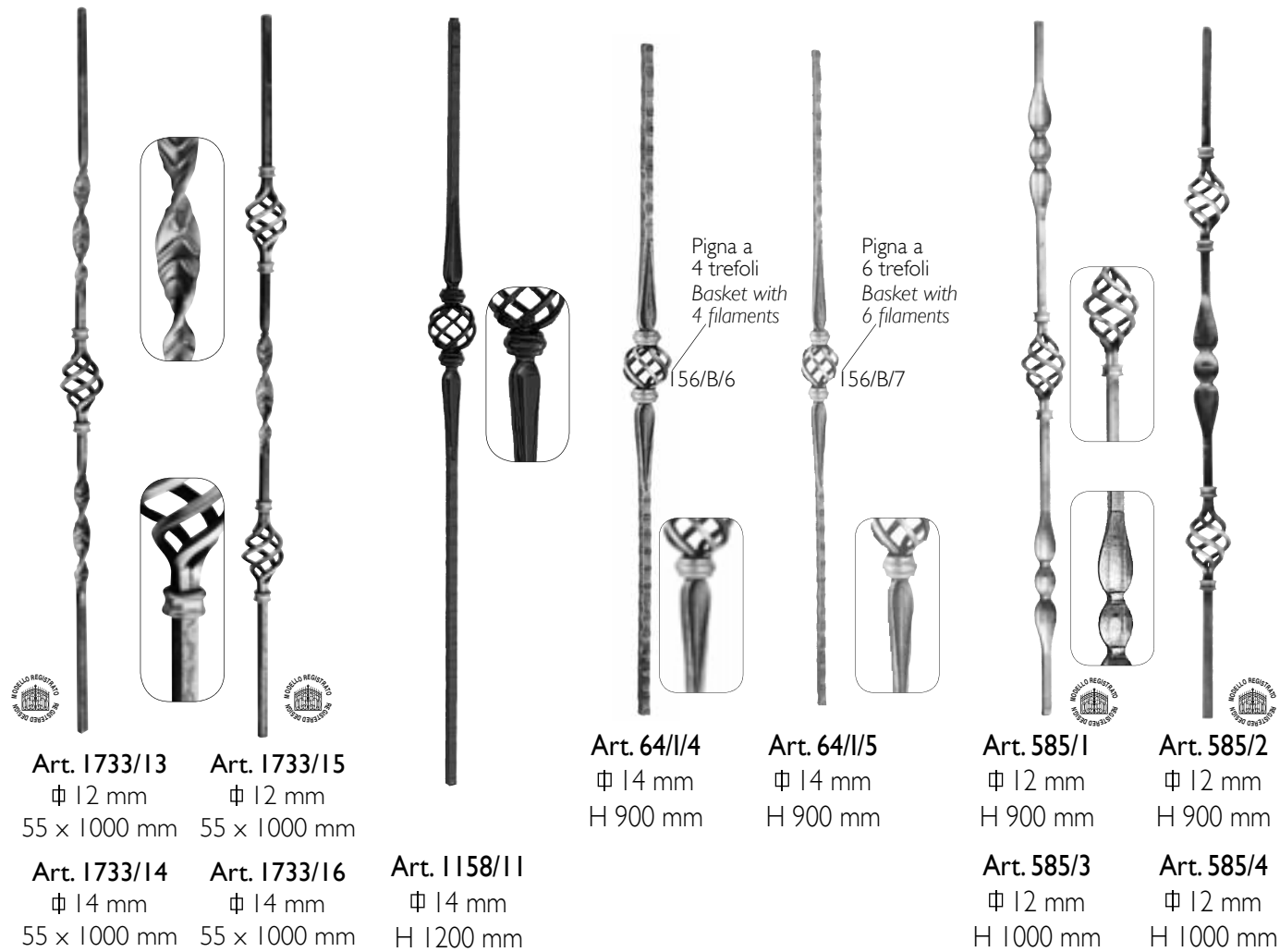

Art. 1733/13 ϕ 12 mm
55 x 1000 mm

Art. 1733/15 ϕ 12 mm
55 x 1000 mm

Art. 1733/14 ϕ 14 mm
55 x 1000 mm

Art. 1733/16 ϕ 14 mm
55 x 1000 mm

Art. 1158/11 ϕ 14 mm
H 1200 mm

Art. 64/I/4 ϕ 14 mm
H 900 mm

Art. 64/I/5 ϕ 14 mm
H 900 mm

Art. 585/1 ϕ 12 mm
H 900 mm

Art. 585/2 ϕ 12 mm
H 900 mm

Art. 585/3 ϕ 12 mm
H 1000 mm

Art. 585/4 ϕ 12 mm
H 1000 mm

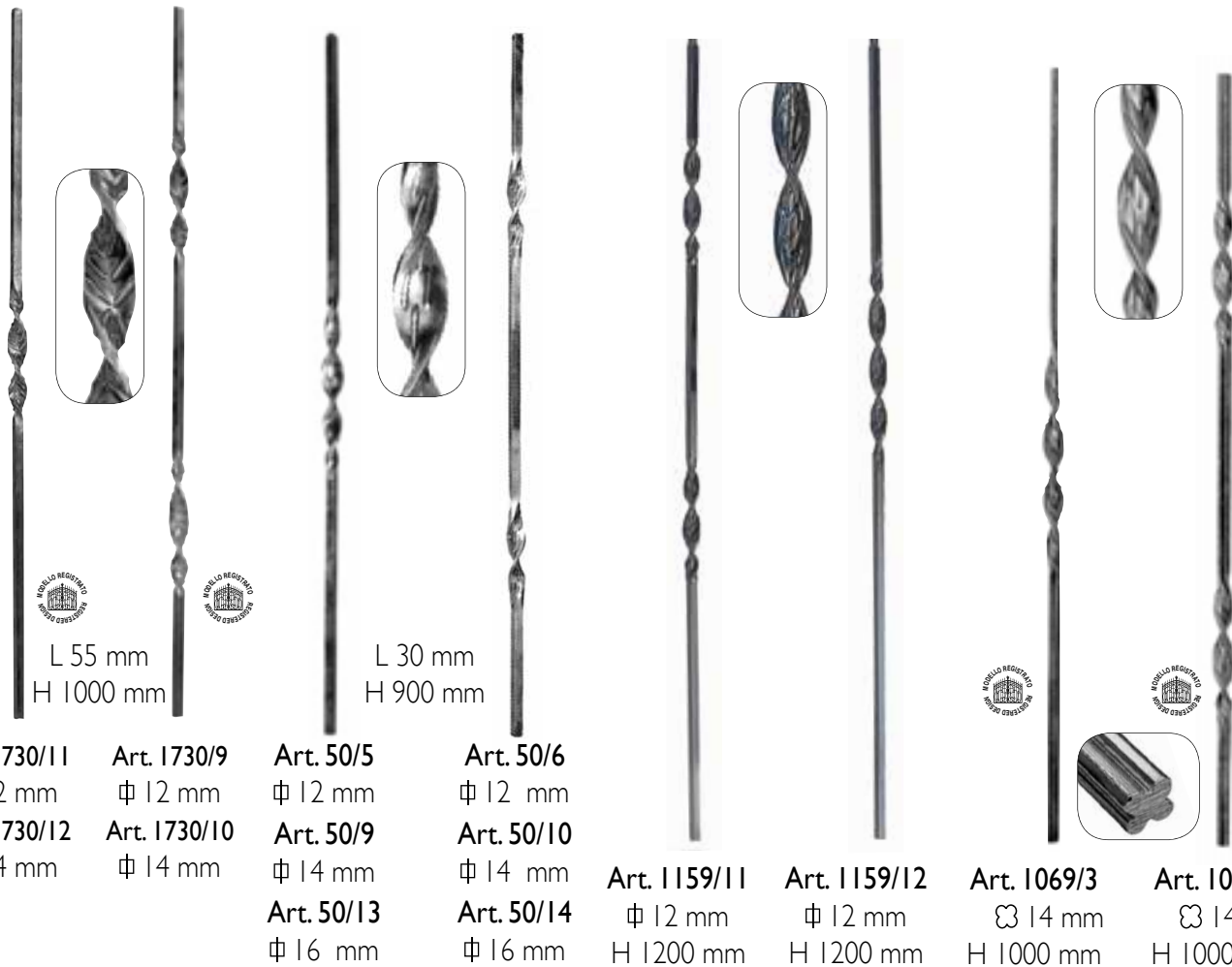

Art. 1730/11 L 55 mm
H 1000 mm

Art. 1730/9 L 30 mm
H 900 mm

Art. 50/5 ϕ 12 mm

Art. 50/6 ϕ 12 mm

Art. 1730/12 ϕ 14 mm

Art. 1730/10 ϕ 14 mm

Art. 50/9 ϕ 14 mm

Art. 50/10 ϕ 14 mm

Art. 50/13 ϕ 16 mm

Art. 50/14 ϕ 16 mm

Art. 1159/11 ϕ 12 mm
H 1200 mm

Art. 1159/12 ϕ 12 mm
H 1200 mm

Art. 1069/3 ϕ 14 mm
H 1000 mm

Art. 1069/4 ϕ 14 mm
H 1000 mm

CAPOSALDI CONSIGLIATI
SUGGESTED NEWEL POSTS



Art. 64/F/1
Φ 25 x 25 mm
H 1200 mm

Art. 801/1
Ø 25 mm
H 1200 mm
Art. 801/7
Ø 30 mm
H 1200 mm

H 900 mm H 1000 mm H 900 mm H 1000 mm

Sez. / Sect.	Cod.art./Art.no.	Cod.art./Art.no.	Cod.art./Art.no.	Cod.art./Art.no.
Φ 12 x 12 mm	64/F/2	-	64/F/4	-
Φ 14 x 14 mm	64/F/3	-	64/F/5	-

Ø 12 mm	573/1	573/7	573/3	573/9
Ø 14 mm	573/2	573/8	573/4	573/10

Φ 12 x 12 mm	-	1137/1	-	1137/3
Φ 14 x 14 mm	-	1137/2	-	1137/4

Art. 1157/2 Art. 1157/3
Φ 14 x 14 mm Φ 14 x 14 mm
H 1200 mm H 1200 mm

CAPOSALDI CONSIGLIATI
SUGGESTED NEWEL POSTS



Art. 801/2
Φ 25 x 25 mm
H 1200 mm

Art. 801/5
Ø 25 mm
H 1200 mm
Art. 801/8
Ø 30 mm
H 1200 mm

H 900 mm H 1000 mm H 900 mm H 1000 mm H 900 mm H 1000 mm

Sez. / Sect.	Cod.art./Art.no.	Cod.art./Art.no.	Cod.art./Art.no.	Cod.art./Art.no.	Cod.art./Art.no.	Cod.art./Art.no.
Φ 12 x 12 mm	578/1	1136/5	578/3	1136/6	-	-
Φ 14 x 14 mm	578/2	1136/9	578/4	1136/10	-	-

Ø 12 mm	-	-	576/3	576/6	576/1	576/5
Ø 14 mm	-	-	576/4	1135/4	576/2	1135/3

CAPOSALDI CONSIGLIATI
SUGGESTED NEWEL POSTS



Art. 1774/4
Φ 25 x 25 mm
H 1200 mm

Art. 1777/9
Φ 25 x 25 mm
H 1200 mm



H 1000 mm

H 1000 mm

H 1000 mm

H 55 x 1000 mm

H 55 x 1000 mm



Sez. / Sect.	Cod.art./Art.no.	Cod.art./Art.no.	Cod.art./Art.no.	Cod.art./Art.no.	Cod.art./Art.no.
Φ 12 x 12 mm	1705/1	1705/3	1705/5	1733/1	1733/3
Φ 14 x 14 mm	1705/2	1705/4	1705/6	1733/2	1733/4
Φ 12 x 12 mm	1707/1	1707/3	1707/5	-	-
Φ 14 x 14 mm	1707/2	1707/4	1707/6	-	-
Φ 12 x 12 mm	1710/1	1710/3	1710/5	-	-
Φ 14 x 14 mm	1710/2	1710/4	1710/6	-	-
Φ 12 x 12 mm	1716/1	1716/3	1716/5	-	-
Φ 14 x 14 mm	1716/2	1716/4	1716/6	-	-

CAPOSALDI
CONSIGLIATI
VEDI PAGINA 231

SUGGESTED
NEWEL POSTS
ON PAGES 231



Art. NEW0018
Φ 12 x 12 mm
H 1000 mm

Art. NEW0019
Φ 14 x 14 mm
H 1000 mm

Art. NEW0020
Φ 12 x 12 mm
H 1000 mm

Art. NEW0021
Φ 14 x 14 mm
H 1000 mm

Art. NEW0022
Φ 12 x 12 mm
H 1000 mm

Art. NEW0023
Φ 14 x 14 mm
H 1000 mm

Art. NEW0029
Φ 12 x 12 mm
H 1000 mm

Art. NEW0030
Φ 14 x 14 mm
H 1000 mm

Art. NEW0031
Φ 12 x 12 mm
H 1000 mm

Art. NEW0032
Φ 14 x 14 mm
H 1000 mm

Art. NEW0033
Φ 12 x 12 mm
H 1000 mm

Art. NEW0034
Φ 14 x 14 mm
H 1000 mm



CAPOSALDI CONSIGLIATI
SUGGESTED NEWEL POSTS

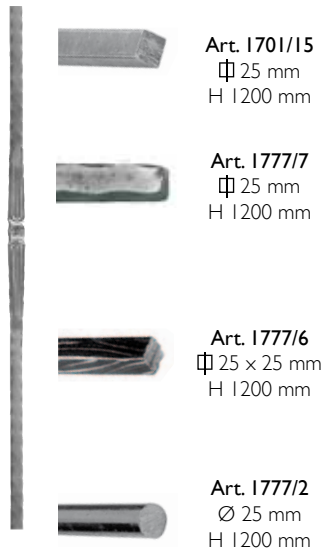

Art. 1701/15
Φ 25 mm
H 1200 mm

Art. 1777/7
Φ 25 mm
H 1200 mm

Art. 1777/6
Φ 25 x 25 mm
H 1200 mm

Art. 1777/2
Ø 25 mm
H 1200 mm

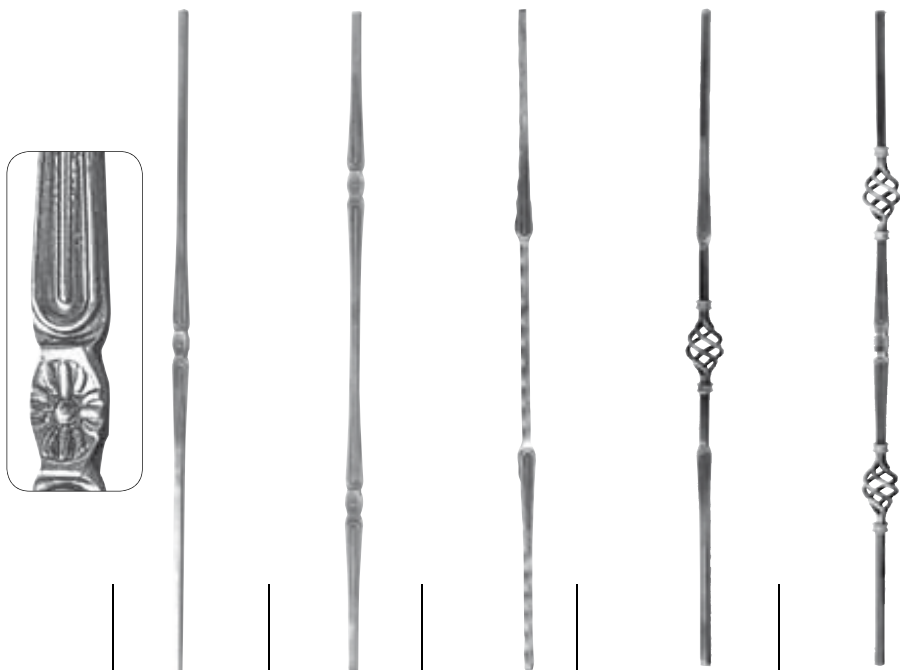

H 1000 mm H 1000 mm H 1000 mm H 55 x 1000 mm H 55 x 1000 mm

Sez. / Sect.	Cod.art./Art.no.	Cod.art./Art.no.	Cod.art./Art.no.	Cod.art./Art.no.	Cod.art./Art.no.
Φ 12 x 12 mm	1701/1	1701/3	1701/5	1733/9	1733/11
Φ 14 x 14 mm	1701/2	1701/4	1701/6	1733/10	1733/12
Φ 12 x 12 mm	1709/1	1709/3	1709/5	-	-
Φ 14 x 14 mm	1709/2	1709/4	1709/6	-	-
Φ 12 x 12 mm	1710/13	1710/15	1710/17	-	-
Φ 14 x 14 mm	1710/14	1710/16	1710/18	-	-
Ø 12 mm	1716/13	1716/15	1716/17	-	-
Ø 14 mm	1716/14	1716/16	1716/18	-	-

Ø = diameter

CAPOSALDI CONSIGLIATI
SUGGESTED NEWEL POSTS

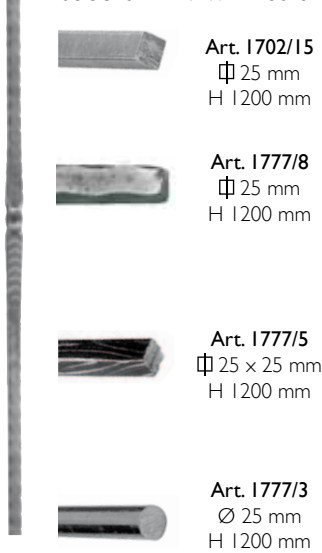

Art. 1702/15
Φ 25 mm
H 1200 mm

Art. 1777/8
Φ 25 mm
H 1200 mm

Art. 1777/5
Φ 25 x 25 mm
H 1200 mm

Art. 1777/3
Ø 25 mm
H 1200 mm



H 1000 mm H 1000 mm H 1000 mm H 55 x 1000 mm H 55 x 1000 mm

Sez. / Sect.	Cod.art./Art.no.	Cod.art./Art.no.	Cod.art./Art.no.	Cod.art./Art.no.	Cod.art./Art.no.
Φ 12 x 12 mm	1702/1	1702/3	1702/5	1733/5	1733/7
Φ 14 x 14 mm	1702/2	1702/4	1702/6	1733/6	1733/8
Φ 12 x 12 mm	1709/13	1709/15	1709/17	-	-
Φ 14 x 14 mm	1709/14	1709/16	1709/18	-	-
Φ 12 x 12 mm	1713/1	1713/3	1713/5	-	-
Φ 14 x 14 mm	1713/2	1713/4	1713/6	-	-
Ø 12 mm	1714/1	1714/3	1714/5	-	-
Ø 14 mm	1714/2	1714/4	1714/6	-	-

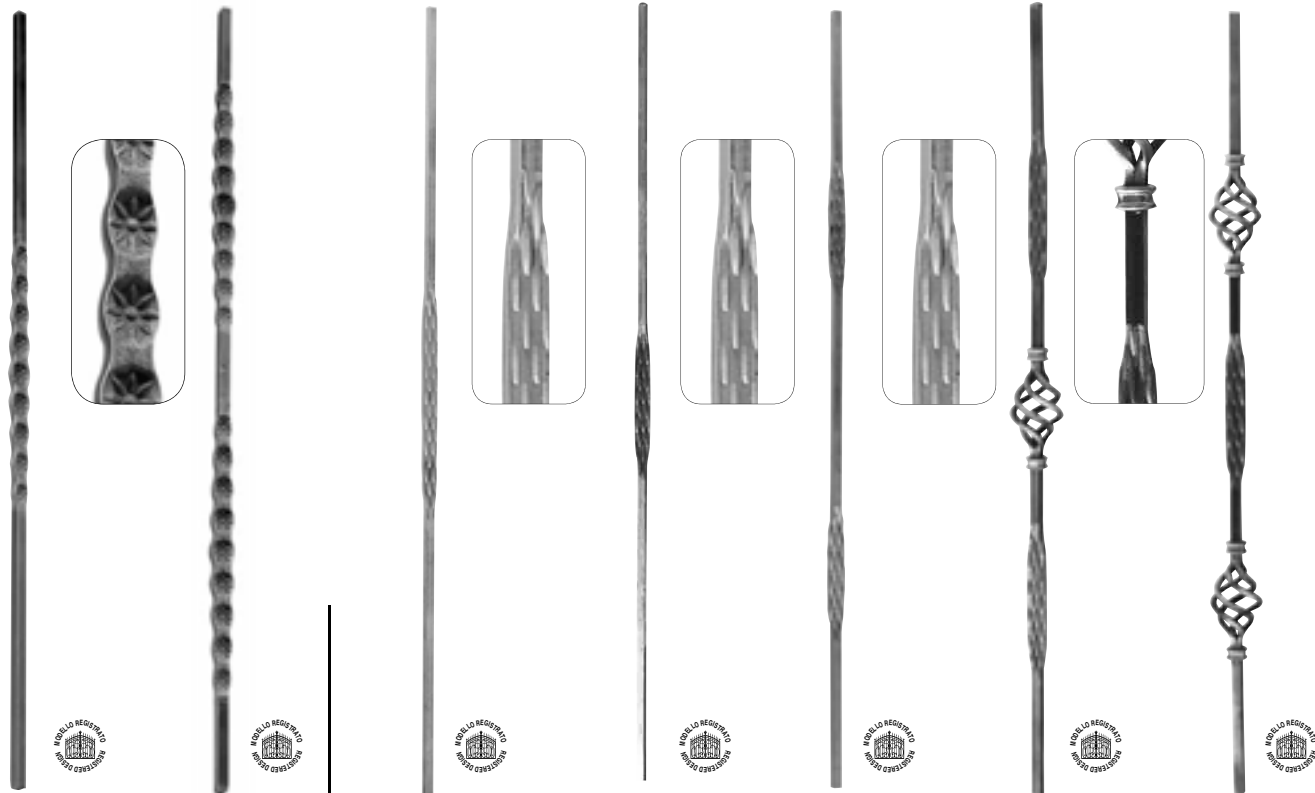

Art. 1718/9 Φ 12 × 12 mm H 1000 mm	Art. 1718/11 Φ 12 × 12 mm H 1000 mm	Art. 1727/1 Φ 12 × 12 mm H 1000 mm	Art. 1729/11 Φ 12 × 12 mm H 1000 mm	Art. 1727/3 Φ 12 × 12 mm H 1000 mm	Art. 1729/3 Φ 12 × 12 mm H 1000 mm	Art. 1729/1 Φ 12 × 12 mm H 1000 mm
Art. 1718/10 Φ 14 × 14 mm H 1000 mm	Art. 1718/12 Φ 14 × 14 mm H 1000 mm	Art. 1727/2 Φ 14 × 14 mm H 1000 mm	Art. 1729/12 Φ 14 × 14 mm H 1000 mm	Art. 1727/4 Φ 14 × 14 mm H 1000 mm	Art. 1729/4 L 55 mm Φ 14 × 14 mm H 1000 mm	Art. 1729/2 L 55 mm Φ 14 × 14 mm H 1000 mm

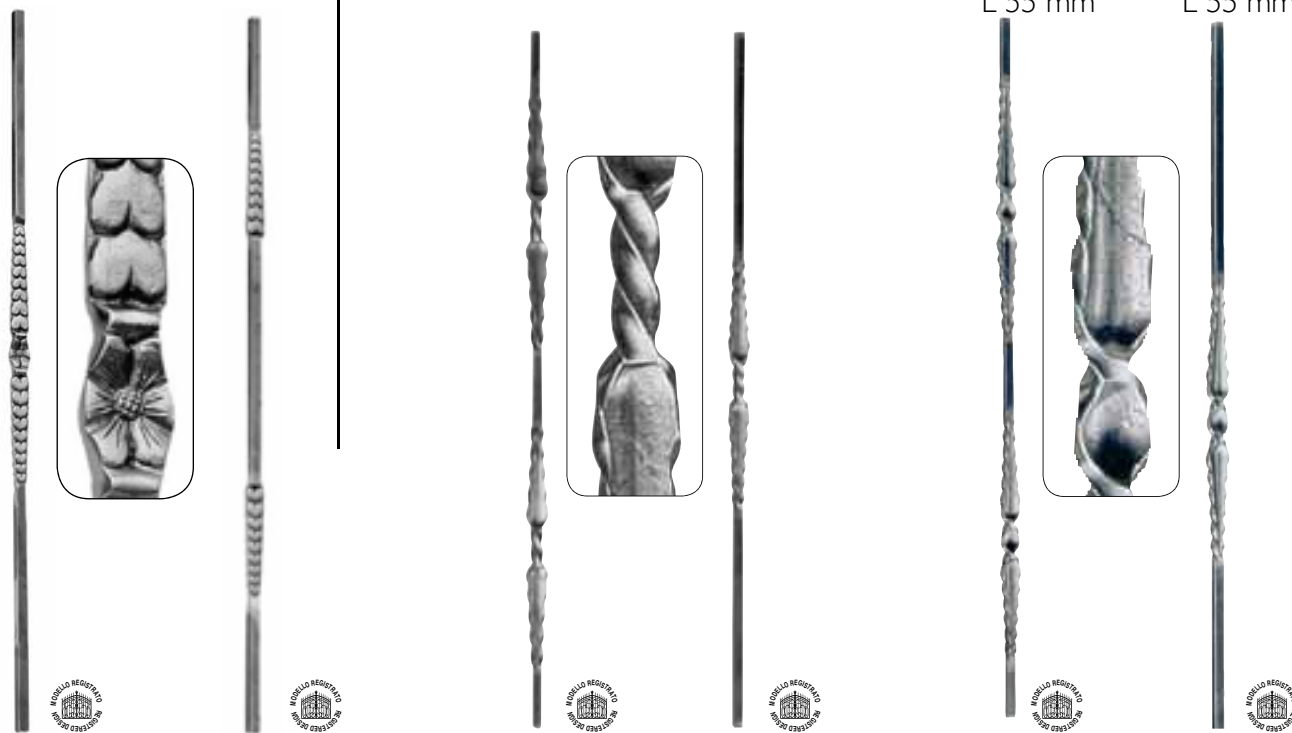

Art. 1718/13 Φ 12 × 12 mm H 1000 mm	Art. 1718/15 Φ 12 × 12 mm H 1000 mm	Art. 1730/1 Φ 12 × 12 mm H 1000 mm	Art. 1730/3 Φ 12 × 12 mm H 1000 mm	Art. 1730/5 Φ 12 × 12 mm H 1000 mm	Art. 1730/7 Φ 12 × 12 mm H 1000 mm
Art. 1718/14 Φ 14 × 14 mm H 1000 mm	Art. 1718/16 Φ 14 × 14 mm H 1000 mm	Art. 1730/2 Φ 14 × 14 mm H 1000 mm	Art. 1730/4 Φ 14 × 14 mm H 1000 mm	Art. 1730/6 Φ 14 × 14 mm H 1000 mm	Art. 1730/8 Φ 14 × 14 mm H 1000 mm

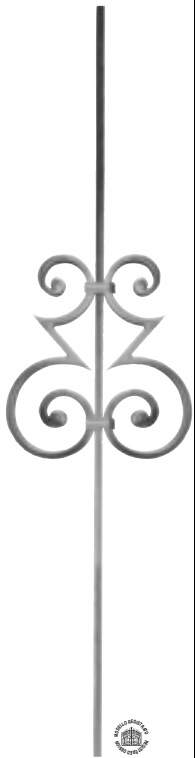
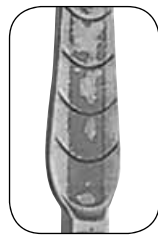
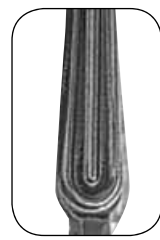
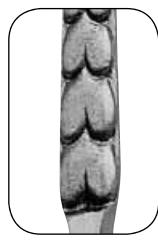
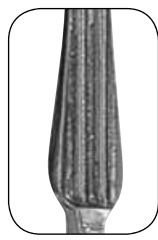
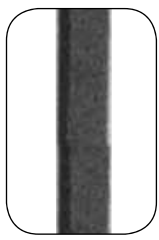

Art. GDI99/1
 □ 14 x 8 mm
 H 1000 mm
 L 210 mm

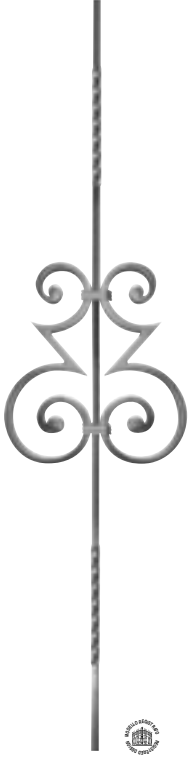

Art. GDI99/2
 □ 14 x 8 mm
 H 1000 mm
 L 210 mm

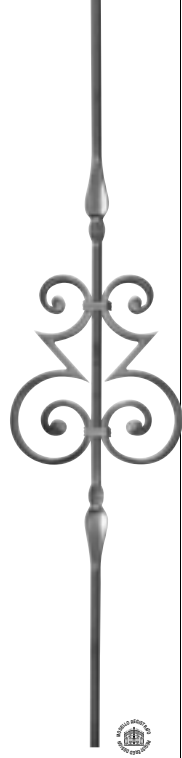

Art. GDI99/4
 Φ 14 x 14 mm
 H 1000 mm
 L 215 mm

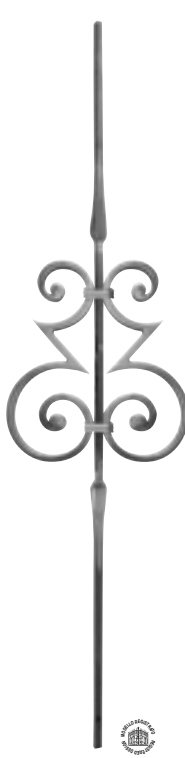

Art. GDI99/3
 Φ 14 x 14 mm
 H 1000 mm
 L 215 mm

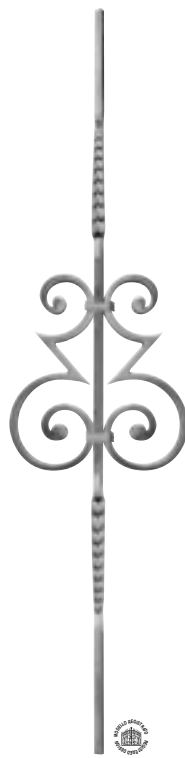

Art. GDI99/5
 Φ 14 x 14 mm
 H 1000 mm
 L 215 mm

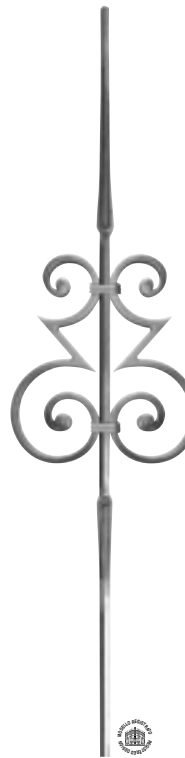

Art. GDI99/6
 Φ 14 x 14 mm
 H 1000 mm
 L 215 mm

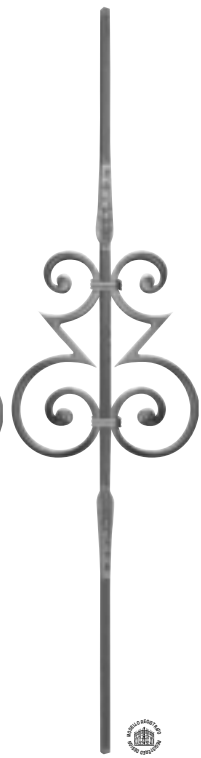

Art. GDI99/7
 Φ 14 x 14 mm
 H 1000 mm
 L 215 mm

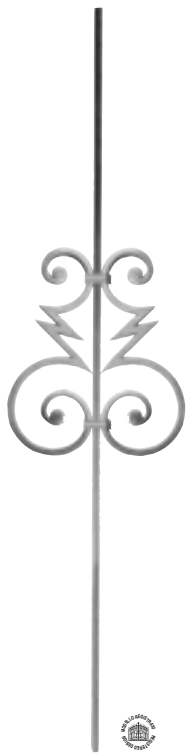

Art. GDI95/1
 □ 14 x 8 mm
 H 1000 mm
 L 210 mm

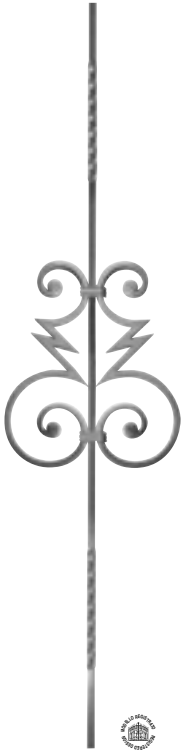

Art. GDI95/2
 □ 14 x 8 mm
 H 1000 mm
 L 210 mm

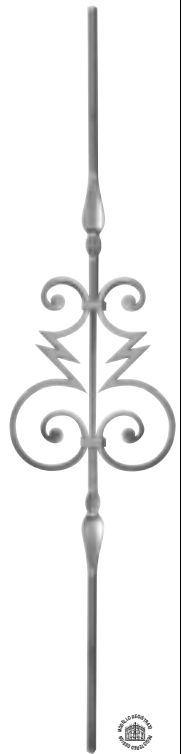

Art. GDI95/4
 Φ 14 x 14 mm
 H 1000 mm
 L 215 mm

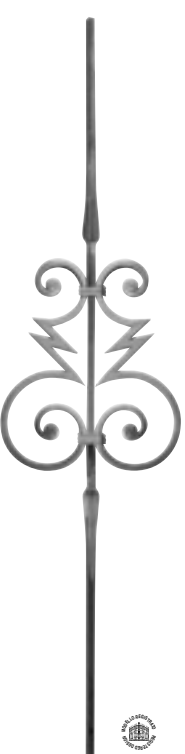

Art. GDI95/3
 Φ 14 x 14 mm
 H 1000 mm
 L 215 mm

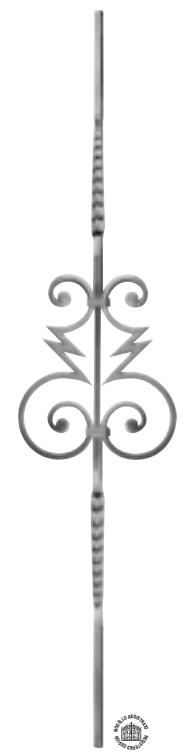

Art. GDI95/5
 □ 14 x 8 mm
 H 1000 mm
 L 215 mm

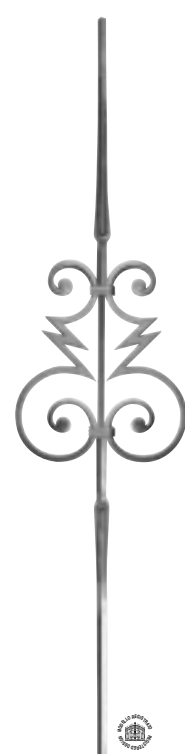

Art. GDI95/6
 Φ 14 x 14 mm
 H 1000 mm
 L 215 mm

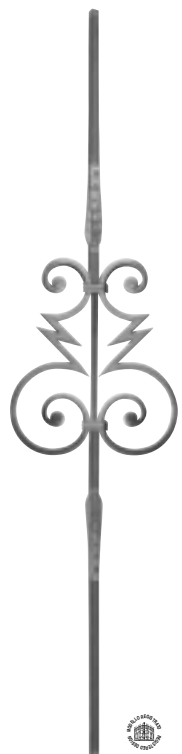

Art. GDI95/7
 Φ 14 x 14 mm
 H 1000 mm
 L 215 mm

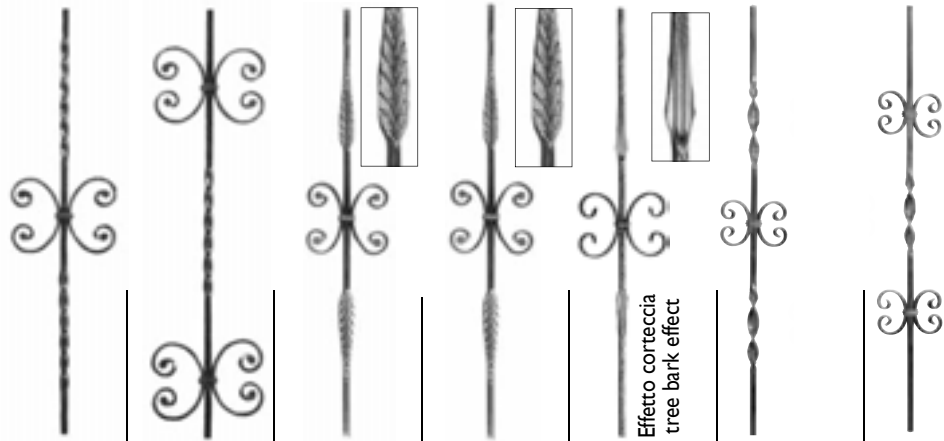

	H 900 mm L 190 mm	H 900 mm L 190 mm	H 900 mm L 170 mm	H 1000 mm L 170 mm	H 1000 mm L 215 mm	H 1000 mm L 145 mm	H 1000 mm L 145 mm
	Cod.art. Art.no.	Cod.art. Art.no.	Cod.art. Art.no.	Cod.art. Art.no.	Cod.art. Art.no.	Cod.art. Art.no.	Cod.art. Art.no.
Φ 12 x 12 mm	51/1	51/2	-	-	1710/7	1730/15	1730/13
Φ 14 x 14 mm	51/4	51/5	-	-	1710/8	1730/16	1730/14
Ø 12 mm	-	-	577/11	577/12			
Ø 14 mm	-	-	577/3	577/6			

Effetto corteccia
tree bark effect

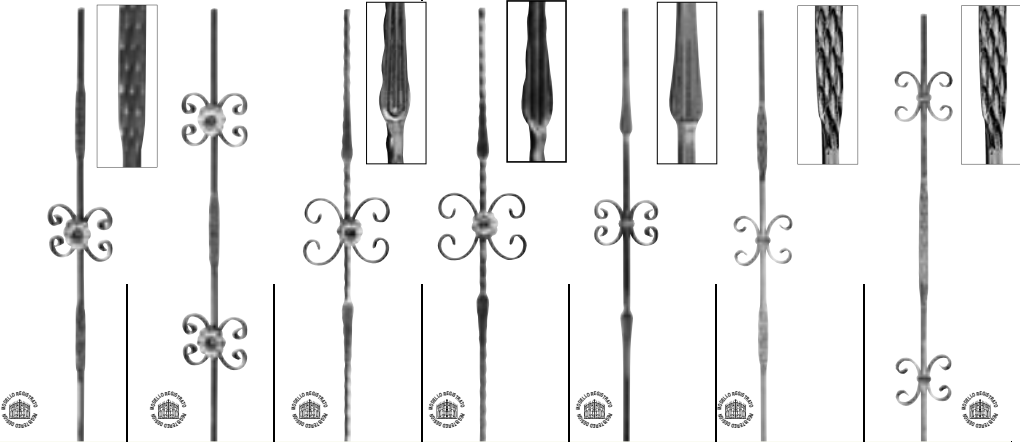



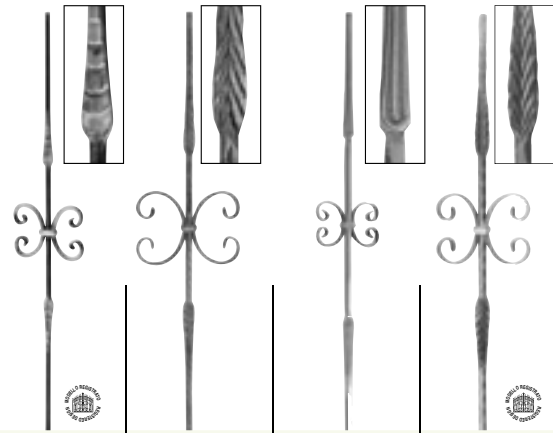





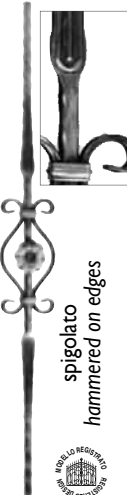
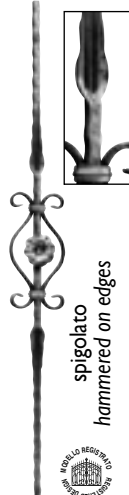
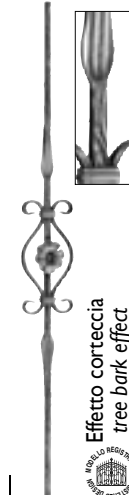

	H 1000 mm L 145 mm	H 1000 mm L 145 mm	H 1000 mm L 215 mm	H 1000 mm L 215 mm	H 1000 mm L 145 mm	H 1000 mm L 140 mm	H 1000 mm L 140 mm
	Cod.art. Art.no.	Cod.art. Art.no.	Cod.art. Art.no.	Cod.art. Art.no.	Cod.art. Art.no.	Cod.art. Art.no.	Cod.art. Art.no.
Φ 12 x 12 mm	1729/7	1729/5	1709/7	1707/7	1705/7	1727/5	1727/7
Φ 14 x 14 mm	1729/8	1729/6	1709/8	1707/10	1705/8	1727/6	1727/8
Ø 12 mm	-	-	-	-	-	-	-
Ø 14 mm	-	-	-	-	-	-	-

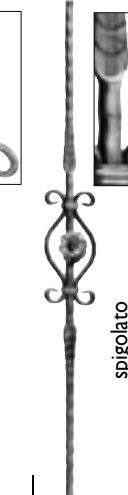
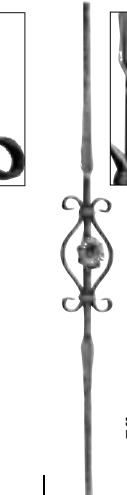
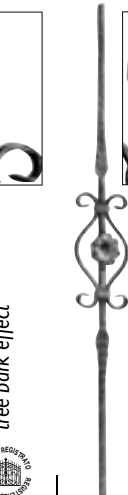



























	H 1000 mm L 175 mm	H 1000 mm L 200 mm	H 1000 mm L 145 mm	H 900 mm L 215 mm
	Cod.art. Art.no.	Cod.art. Art.no.	Cod.art. Art.no.	Cod.art. Art.no.
Φ 12 x 12 mm	-	1138/5	1701/7	578/11
Φ 14 x 14 mm	-	1138/6	1701/8	578/12
Ø 12 mm	1714/7	-	-	-
Ø 14 mm	1714/8	-	-	-



ARTEFERRO

							
	spigliato hammered on edges	spigliato hammered on edges	Effetto corteccia tree bark effect	diamantato diamond hammered	spigliato hammered on edges	Effetto corteccia tree bark effect	Effetto corteccia tree bark effect
H 1000 mm L 110 mm							
	Cod.art./Art.no.	Cod.art./Art.no.	Cod.art./Art.no.	Cod.art./Art.no.	Cod.art./Art.no.	Cod.art./Art.no.	Cod.art./Art.no.
Φ 12 x 12 mm	1709/9	1707/8	1710/9	1138/9	1709/21	1710/21	1713/9
Φ 14 x 14 mm	1709/10	1707/11	1710/10	1138/10	1709/22	1710/22	1713/10

									
			zincato - galvanized				verniciato - painted	verniciato - painted	
									
	H 900 mm L 170 mm	H 900 mm L 170 mm	H 900 mm L 170 mm	H 1000 mm L 170 mm	H 1000 mm L 170 mm	H 1000 mm L 170 mm	H 1120 mm L 170 mm	H 1200 mm L 170 mm	H 1200 mm L 170 mm
	Cod.art. Art.no.	Cod.art. Art.no.	Cod.art. Art.no.	Cod.art. Art.no.	Cod.art. Art.no.	Cod.art. Art.no.	Cod.art. Art.no.	Cod.art. Art.no.	Cod.art. Art.no.
Φ 12 x 12 mm	52/A/3	52/A/5	185/4	-	-	-	1487/1	1487/2	1160/5
Φ 14 x 14 mm	-	-	-	-	-	-	-	-	-
Ø 12 mm	-	-	-	1716/11	1714/11	1716/23	-	-	-
Ø 14 mm	-	-	-	1716/12	1714/12	1716/24	-	-	-

						
					diamantato diamond hammered	
						
	H 1000 mm L 200 mm	H 900 mm L 180 mm	H 900 mm L 180 mm	H 900 mm L 250 mm	H 1200 mm	H 1200 mm
	Cod.art./Art.no.	Cod.art./Art.no.	Cod.art./Art.no.	Cod.art./Art.no.	Cod.art./Art.no.	Cod.art./Art.no.
Φ 12 x 12 mm	-	584/A/1	584/A/2	-	1159/10	1159/9
Φ 14 x 14 mm	-	-	-	-	-	-
Ø 12 mm	1066/6	-	-	-	-	-
Ø 14 mm	-	-	-	134/F/2	-	-

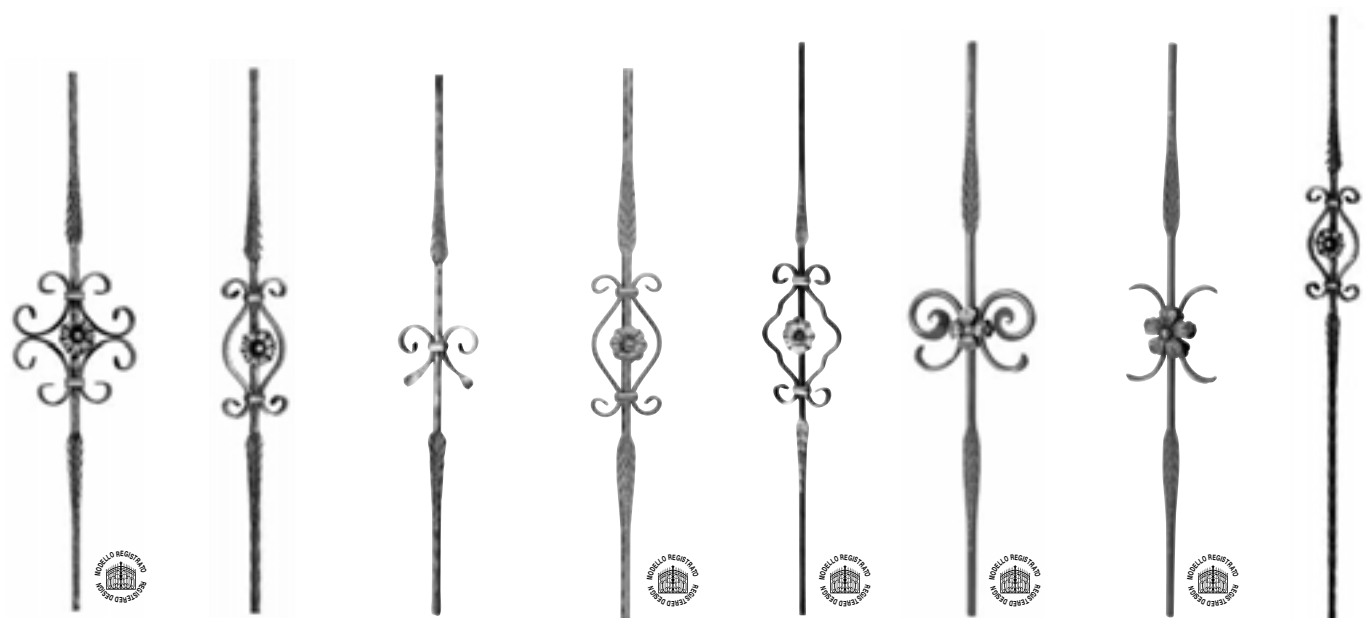

- | | | | | | | | |
|------------------------------------------------------------------------------------------------|------------------------------------------------------------------------------------------|------------------------------------------------------------------------------------------|----------------------------------------------------------------------------------------|-------------------------------------------------------------------------------------------------------------------|--------------------------------------------------------|--------------------------------------------------------|-------------------------------------------------|
| H 900 mm
L 210 mm
Art. 561/5
Ø 12 x 12 mm
Art. 561/6
Ø 14 x 14 mm | Art. 64/F/8
H 900 mm
L 110 mm
Art. 64/F/9
H 900 mm
L 110 mm | Art. 64/F/6
H 900 mm
L 140 mm
Art. 64/F/7
H 900 mm
L 140 mm | Art. 578/5
H 900 mm
L 110 mm
Art. 578/6
H 900 mm
L 110 mm | Art. 1714/9
Ø 12 mm
H 1000 mm
L 170 mm
Art. 1714/10
Ø 14 mm
H 1000 mm
L 170 mm | Art. 1135/1
Ø 14 mm
H 1000 mm
L 220 mm | Art. 1135/2
Ø 14 mm
H 1000 mm
L 150 mm | Art. 1157/5
Ø 14 x 14 mm
H 1200 mm |
|------------------------------------------------------------------------------------------------|------------------------------------------------------------------------------------------|------------------------------------------------------------------------------------------|----------------------------------------------------------------------------------------|-------------------------------------------------------------------------------------------------------------------|--------------------------------------------------------|--------------------------------------------------------|-------------------------------------------------|



- | | | |
|-------------------------------------------------|-------------------------------------------------|------------------------------------------------------|
| Art. 1749/5
Ø 12 x 12 mm
H 1000 mm | Art. 1749/7
Ø 12 x 12 mm
H 1000 mm | Art. 1701/9
Ø 12 x 12 mm
175 x 1000 mm |
| Art. 1749/6
Ø 14 x 14 mm
H 1000 mm | Art. 1749/8
Ø 14 x 14 mm
H 1000 mm | Art. 1701/10
Ø 14 x 14 mm
175 x 1000 mm |



ARTEFERRO



Art. 1701/11
 Ø 12 x 12 mm
 H 1000 mm
 L 145 mm



Art. 1702/7
 Ø 12 x 12 mm
 H 1000 mm
 L 145 mm



Art. 1702/9
 Ø 12 x 12 mm
 H 1000 mm
 L 145 mm



Art. 1702/11
 Ø 12 x 12 mm
 H 1000 mm
 L 175 mm



Art. 1705/9
 Ø 12 x 12 mm
 H 1000 mm
 L 175 mm



Art. 1705/11
 Ø 12 x 12 mm
 H 1000 mm
 L 145 mm



Art. 1709/19
 Ø 12 x 12 mm
 H 1000 mm
 L 215 mm

Art. 1701/12
 Ø 14 x 14 mm
 H 1000 mm
 L 145 mm

Art. 1702/8
 Ø 14 x 14 mm
 H 1000 mm
 L 145 mm

Art. 1702/10
 Ø 14 x 14 mm
 H 1000 mm
 L 145 mm

Art. 1702/12
 Ø 14 x 14 mm
 H 1000 mm
 L 175 mm

Art. 1705/10
 Ø 14 x 14 mm
 H 1000 mm
 L 175 mm

Art. 1705/12
 Ø 14 x 14 mm
 H 1000 mm
 L 145 mm

Art. 1709/20
 Ø 14 x 14 mm
 H 1000 mm
 L 215 mm

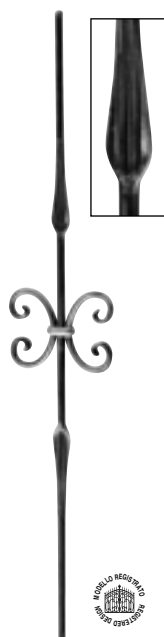

	Cod.art./Art.no.	Cod.art./Art.no.	Cod.art./Art.no.	Cod.art./Art.no.	Cod.art./Art.no.	Cod.art./Art.no.
Ø 12 x 12 mm	-	-	1136/3	1710/19	1713/7	561/3
Ø 14 x 14 mm	-	-	1136/7	1710/20	1713/8	561/4
Ø 12 mm	1716/7	1716/19	-	-	-	-
Ø 14 mm	1716/8	1716/20	-	-	-	-



H 900 mm
L 210 mm
Art. 577/1
Ø 14 mm
Art. 577/7
Ø 12 mm



H 1000 mm
L 210 mm
Art. 577/4
Ø 14 mm
Art. 577/8
Ø 12 mm



Art. 571/3
Ø 12 x 12 mm
H 900 mm
L 200 mm
Art. 571/4
Ø 14 x 14 mm
H 900 mm
L 200 mm



Art. 1136/1
Ø 14 mm
H 1000 mm
L 190 mm

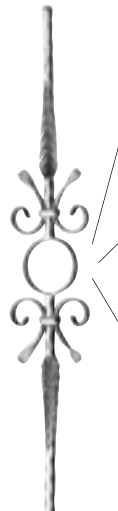

medaglia in ottone / brass embellishment



Ø 12 x 12 mm - **Art. 568/1**
Ø 14 x 14 mm - **Art. 568/2**

medaglia in legno / wood embellishment



Ø 12 x 12 mm - **Art. 566/5**
Ø 14 x 14 mm - **Art. 566/6**

medaglia in vetro / glass embellishment



Ø 12 x 12 mm - **Art. 569/1**
Ø 14 x 14 mm - **Art. 569/2**



ARTEFERRO



Art. 578/7
Ø 12 x 12 mm
H 900 mm
L 140 mm
Art. 578/8
Ø 14 x 14 mm
H 900 mm
L 140 mm



Art. 578/9
Ø 12 x 12 mm
H 900 mm
L 225 mm
Art. 578/10
Ø 14 x 14 mm
H 900 mm
L 225 mm



Art. 1137/5
Ø 12 x 12 mm
H 1000 mm
L 225 mm
Art. 1137/6
Ø 14 x 14 mm
H 1000 mm
L 225 mm



H 900 mm
L 170 mm
Art. 577/2
Ø 14 mm
Art. 577/9
Ø 12 mm



H 1000 mm
L 170 mm
Art. 577/5
Ø 14 mm
Art. 577/10
Ø 12 mm



Art. 1489/7
Ø 14 x 14 mm
H 1120 mm
Art. 1489/8
Ø 14 x 14 mm
H 1200 mm



Art. 1157/4
Ø 14 x 14 mm
H 1200 mm



H 1000 mm

Sezione Section	Cod.art. Art.no.	Cod.art. Art.no.	Cod.art. Art.no.	Cod.art. Art.no.	Cod.art. Art.no.	Cod.art. Art.no.	Cod.art. Art.no.	Cod.art. Art.no.	Cod.art. Art.no.
Φ 12 x 12 mm	1720/1	1720/3	1720/5	1720/7	1720/9	1720/11	1721/1	1721/3	1721/5
Φ 14 x 14 mm	1720/2	1720/4	1720/6	1720/8	1720/10	1720/12	1721/2	1721/4	1721/6

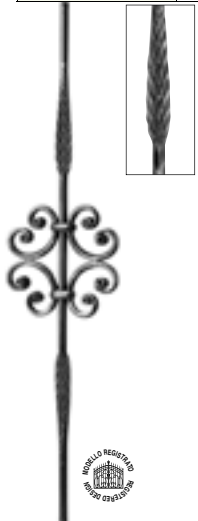

Art. 1136/2
Ø 14 mm
H 1000 mm
L 200 mm



Art. 1136/4
Φ 12 x 12 mm
H 1000 mm
L 200 mm



Art. 1138/3
Φ 12 x 12 mm
H 1000 mm
L 140 mm



Art. 562/1
Φ 12 x 12 mm
H 900 mm



Art. 573/5
Ø 12 mm
H 900 mm



Art. 573/6
Ø 12 mm
H 900 mm



Art. 571/1
Φ 12 x 12 mm
H 900 mm



Art. 571/2
Φ 12 x 12 mm
H 900 mm



Art. 561/1
Φ 12 x 12 mm
H 900 mm
L 215 mm

Art. 561/2
Φ 14 x 14 mm
H 900 mm
L 215 mm



Art. 1540/1
Φ 12 x 12 mm
H 1000 mm
L 260 mm



Art. 1540/2
Φ 12 x 12 mm
H 1000 mm
L 260 mm



Art. 1540/3
Φ 12 x 12 mm
H 1000 mm
L 260 mm



Art. 1540/4
Φ 12 x 12 mm
H 1000 mm
L 260 mm



Art. 1540/5
Φ 12 x 12 mm
H 1000 mm
L 260 mm



Art. 1718/1
 Ø 12 x 12 mm
 H 1000 mm
Art. 1718/2
 Ø 14 x 14 mm
 H 1000 mm

Art. 1718/3
 Ø 12 x 12 mm
 H 1000 mm
Art. 1718/4
 Ø 14 x 14 mm
 H 1000 mm

Art. 1718/5
 Ø 12 x 12 mm
 H 1000 mm
Art. 1718/6
 Ø 14 x 14 mm
 H 1000 mm

Art. 1718/7
 Ø 12 x 12 mm
 H 1000 mm
Art. 1718/8
 Ø 14 x 14 mm
 H 1000 mm



ARTEFERRO



ARTEFERRO

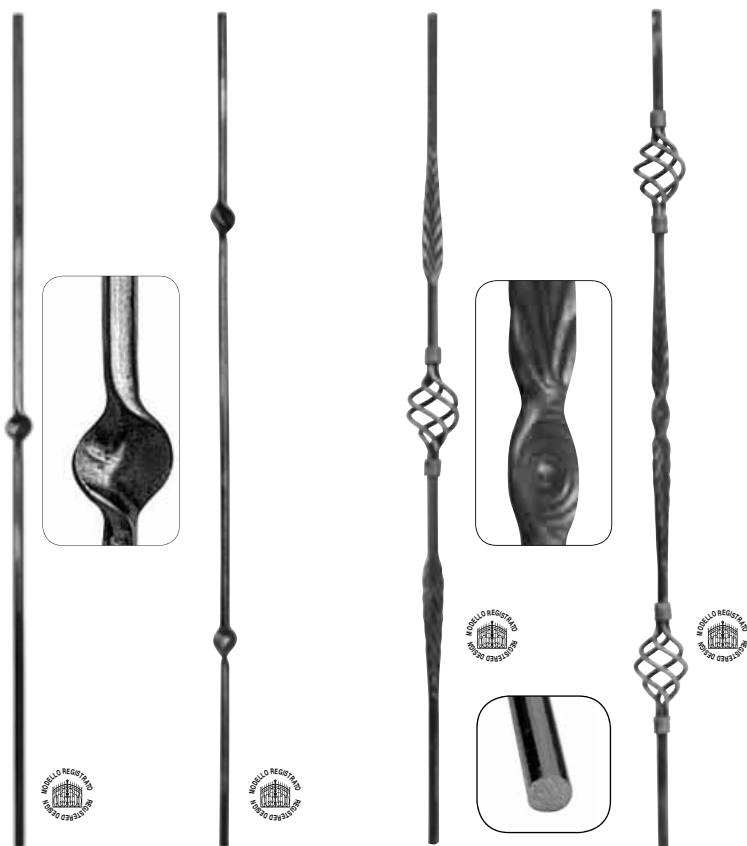

Art. 1067/1
 Ø 12 mm
 H 1000 mm

Art. 1067/2
 Ø 12 mm
 H 1000 mm

Art. 1734/1
 Ø 12 mm
 H 1000 mm
 L 55 mm

Art. 1734/2
 Ø 12 mm
 H 1000 mm
 L 55 mm



Art. 537/1 **Art. 537/2** **Art. 537/3** **Art. 537/4** **Art. 537/5** **Art. 537/6** **Art. 537/7** **Art. 537/8** **Art. 537/9**
 Ø 30 mm Ø 30 mm Ø 30 mm Ø 30 mm Ø 30 mm Ø 30 mm Ø 30 mm Ø 30 mm Ø 30 mm
 H 1000 mm H 1000 mm H 1000 mm H 1000 mm H 1000 mm H 1000 mm H 1000 mm H 1000 mm H 1000 mm

Colonnine in tubo sagomato

Balusters in shaped tube



Art. 146/1 **Art. 146/2** **Art. 149/1** **Art. 149/2** **Art. 1223/1** **Art. 1223/2** **Art. 1223/3**
 Ø 40 mm Ø 40 mm Ø 30 mm Ø 30 mm Ø 30 mm Ø 30 mm Ø 30 mm
 H 900 mm H 1000 mm H 900 mm H 900 mm H 1000 mm H 1000 mm H 1000 mm

• zincato / galvanized Art. 185/3

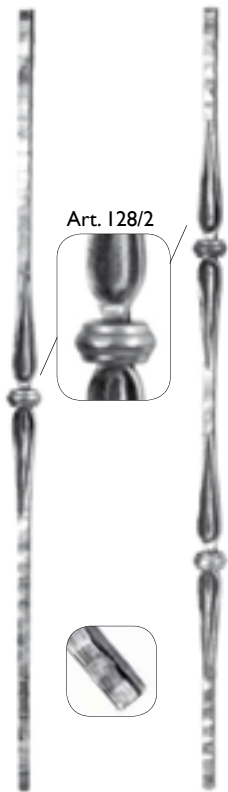

Art. 128/2



Art. 64/1/3 Art. 64/1/2
 Φ 14 x 14 mm Φ 14 x 14 mm
 H 900 mm H 900 mm

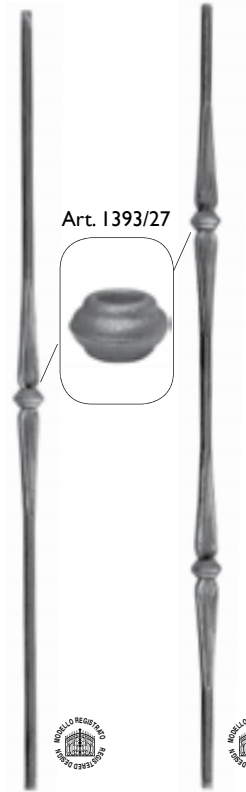

Art. 1393/27



Art. 1177/5 Art. 1177/6
 Ø 12 mm Ø 12 mm
 H 1000 mm H 1000 mm

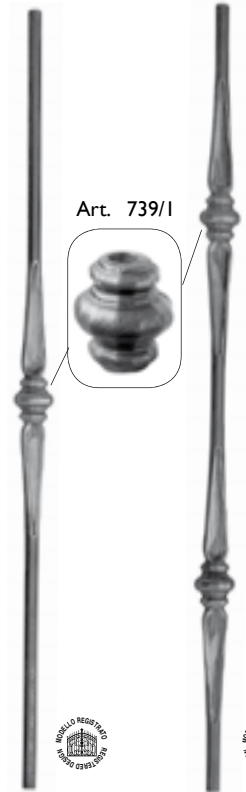

Art. 739/1



Art. 1177/1 Art. 1177/2
 Ø 12 mm Ø 12 mm
 H 1000 mm H 1000 mm

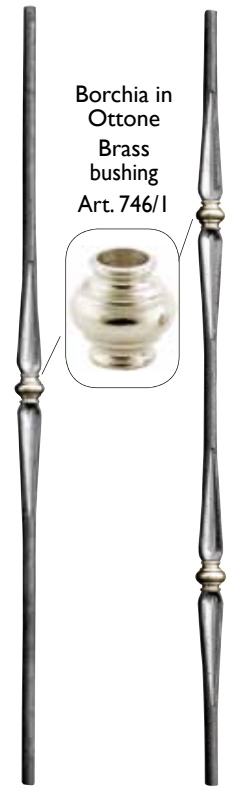

Borchia in Ottone
 Brass bushing
 Art. 746/1



Art. 1179/1 Art. 1179/2
 Ø 12 mm Ø 12 mm
 H 1000 mm H 1000 mm

Art. 1177/7
 Ø 14 mm
 H 1000 mm

Art. 1177/8
 Ø 14 mm
 H 1000 mm

Art. 1177/3
 Ø 14 mm
 H 1000 mm

Art. 1177/4
 Ø 14 mm
 H 1000 mm

Art. 1179/3
 Ø 14 mm
 H 1000 mm

Art. 1179/4
 Ø 14 mm
 H 1000 mm

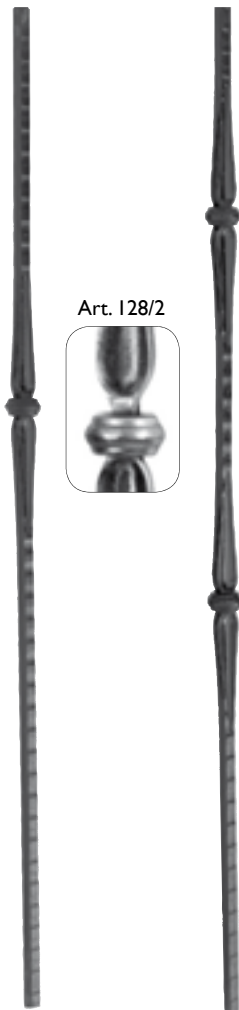

Art. 128/2



Art. 1158/9 Art. 1158/10
 Φ 14 x 14 mm Φ 14 x 14 mm
 H 1200 mm H 1200 mm

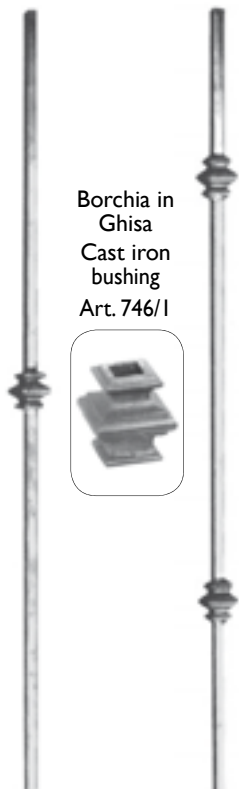

Borchia in Ghisa
 Cast iron bushing
 Art. 746/1



Art. 755/5 Art. 755/6
 Φ 12 x 12 mm Φ 12 x 12 mm
 H 900 mm H 900 mm



Borchia in Ghisa
 Cast iron bushing
 Art. 746/1



Art. 1175/3 Art. 1175/4
 Φ 12 x 12 mm Φ 12 x 12 mm
 H 1000 mm H 1000 mm

Art. 1175/1 Art. 1175/2
 Φ 12 x 12 mm Φ 12 x 12 mm
 H 1000 mm H 1000 mm



ARTEFERRO

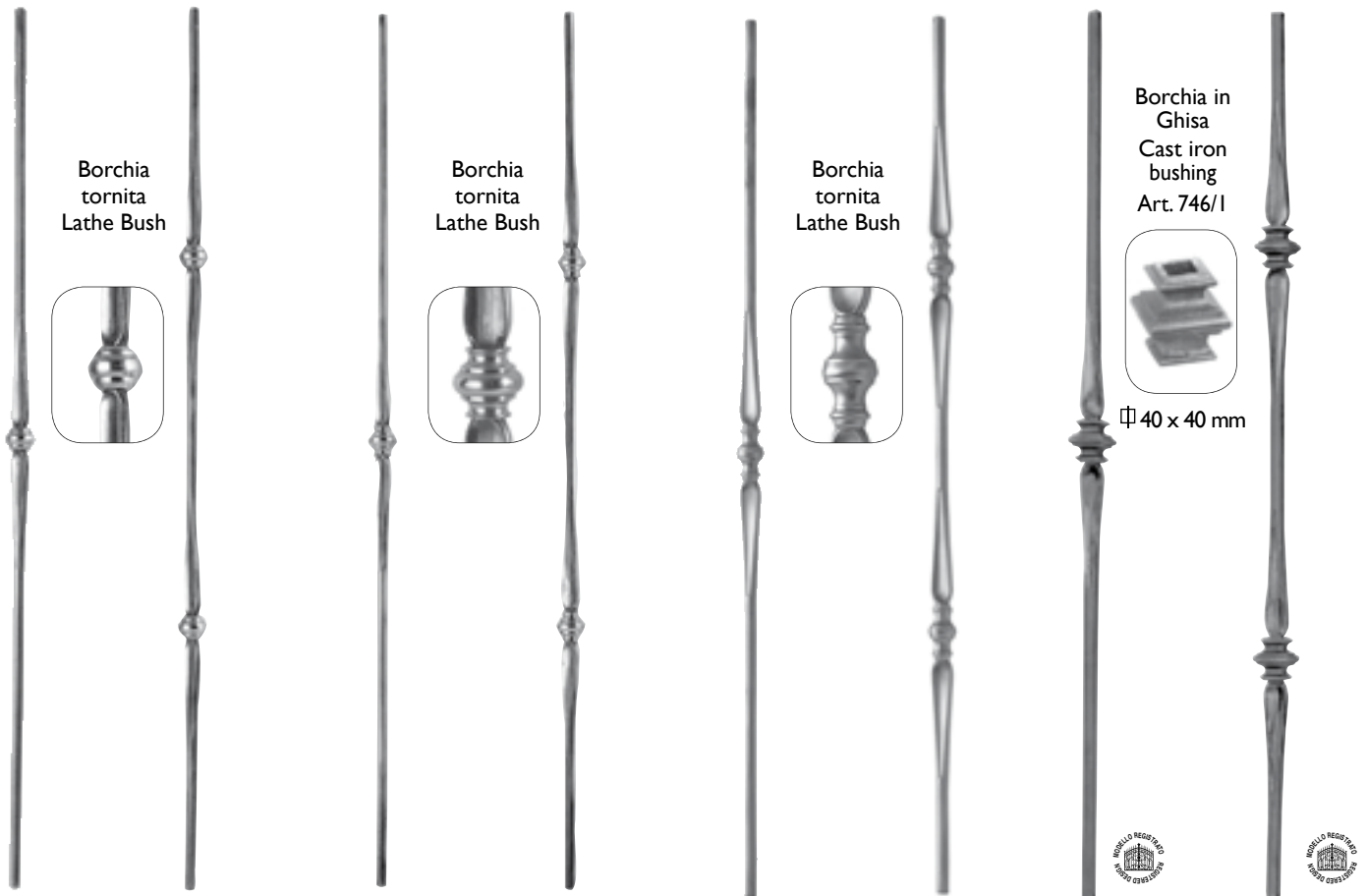

Art. NEW0040	Art. NEW0041	Art. NEW0042	Art. NEW0043	Art. NEW0044	Art. NEW0045	Art. 1176/1	Art. 1176/2
Ø 14 mm	Ø 14 mm	Ø 14 mm	Ø 14 mm	Ø 14 mm	Ø 14 mm	Ø 12 mm	Ø 12 mm
H 1000 mm	H 1000 mm	H 1000 mm	H 1000 mm	H 1000 mm	H 1000 mm	H 1000 mm	H 1000 mm

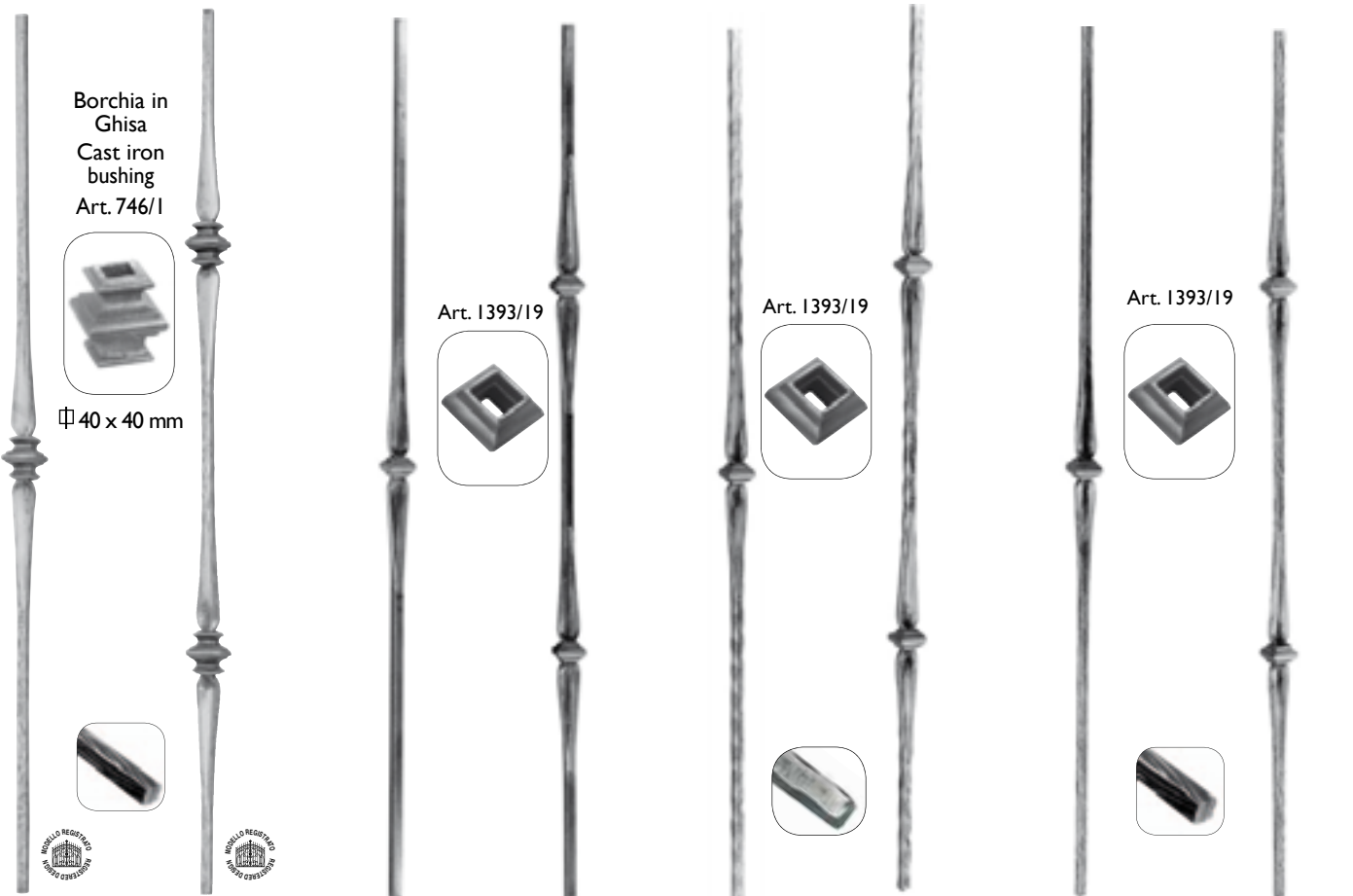

Art. 1176/3	Art. 1176/4	Art. 1746/1	Art. 1746/2	Art. 1746/3	Art. 1746/4	Art. 1746/5	Art. 1746/6
Ø 12 mm	Ø 12 mm	Ø 12 mm	Ø 12 mm	Ø 12 mm	Ø 12 mm	Ø 12 mm	Ø 12 mm
H 1000 mm	H 1000 mm	H 1000 mm	H 1000 mm	H 1000 mm	H 1000 mm	H 1000 mm	H 1000 mm

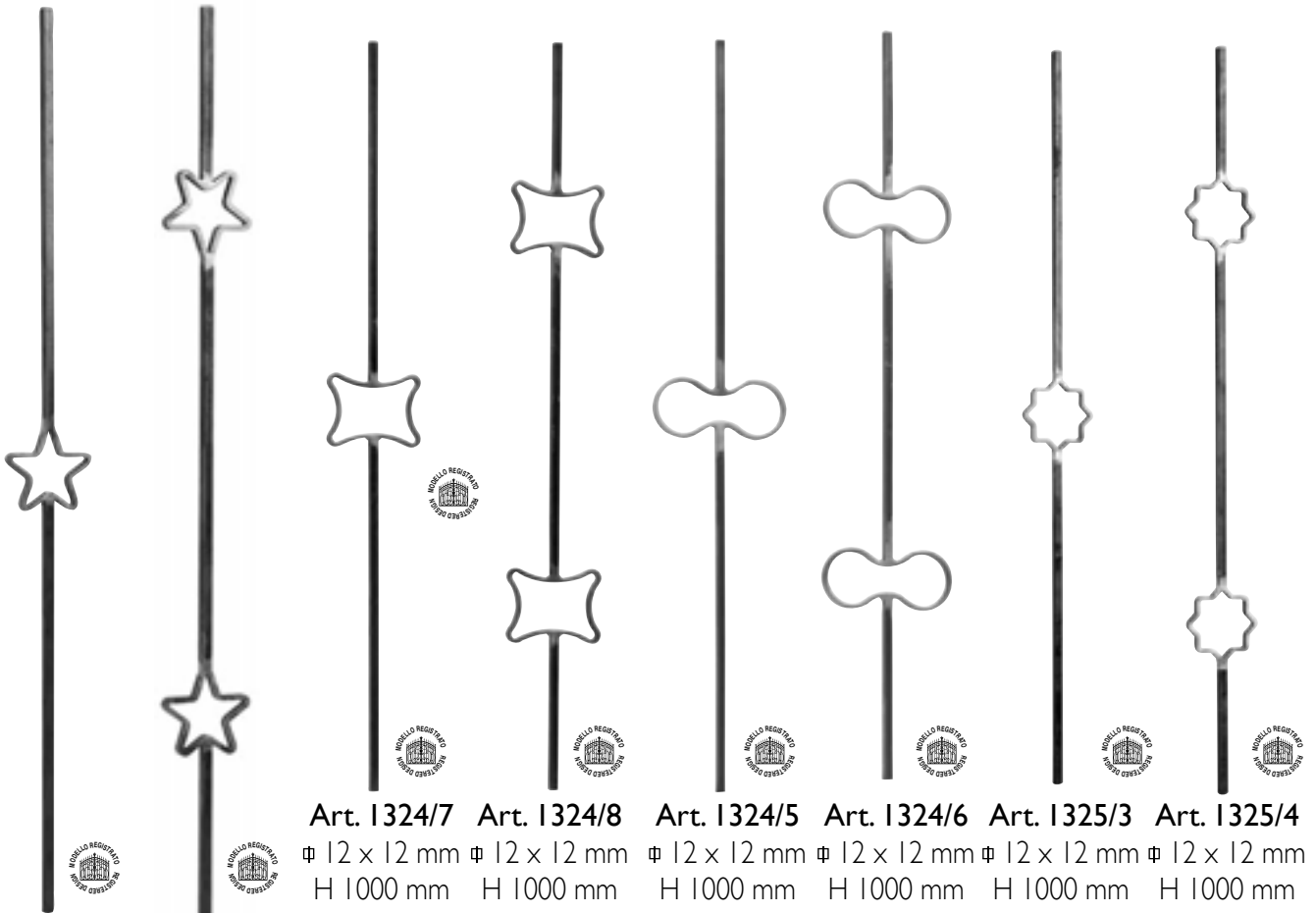

Art. I325/5
 \varnothing 12 x 12 mm
 H 1000 mm
 L 100 mm

Art. I325/6
 \varnothing 12 x 12 mm
 H 1000 mm
 L 100 mm

Art. I324/7
 \varnothing 12 x 12 mm
 H 1000 mm
 L 130 mm

Art. I324/8
 \varnothing 12 x 12 mm
 H 1000 mm
 L 130 mm

Art. I324/5
 \varnothing 12 x 12 mm
 H 1000 mm
 L 180 mm

Art. I324/6
 \varnothing 12 x 12 mm
 H 1000 mm
 L 180 mm

Art. I325/3
 \varnothing 12 x 12 mm
 H 1000 mm
 L 100 mm

Art. I325/4
 \varnothing 12 x 12 mm
 H 1000 mm
 L 100 mm



ARTEFERRO

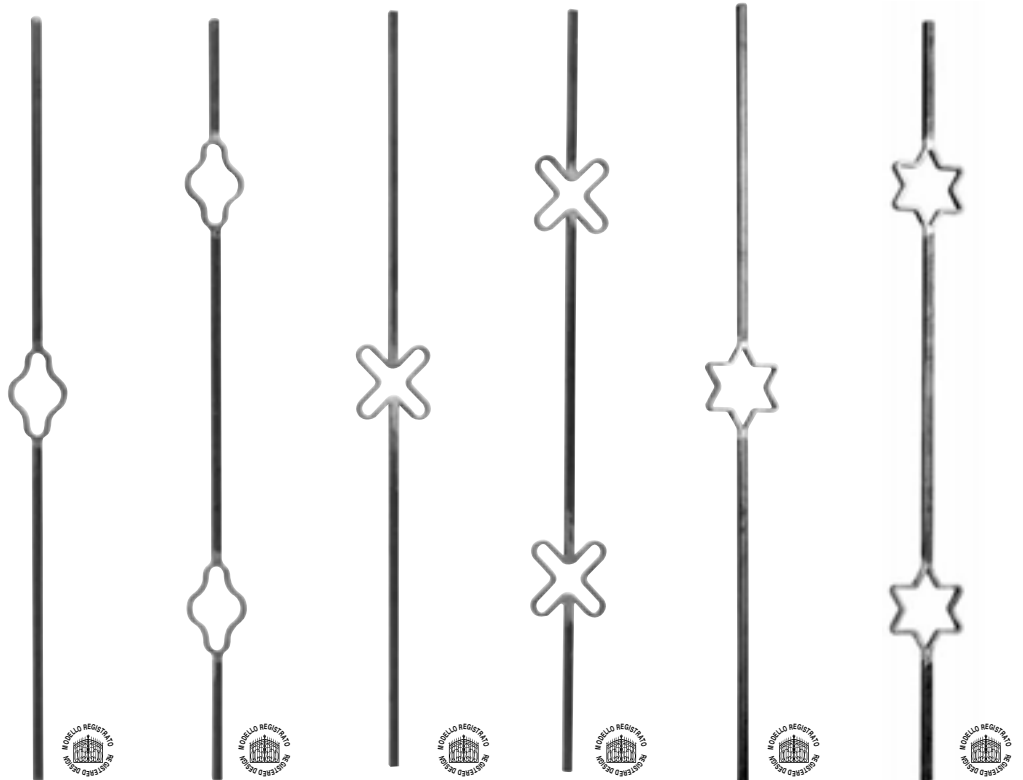

Art. I324/1
 \varnothing 12 x 12 mm
 H 1000 mm
 L 80 mm

Art. I324/2
 \varnothing 12 x 12 mm
 H 1000 mm
 L 80 mm

Art. I324/9
 \varnothing 12 x 12 mm
 H 1000 mm
 L 80 mm

Art. I324/10
 \varnothing 12 x 12 mm
 H 1000 mm
 L 80 mm

Art. I325/7
 \varnothing 12 x 12 mm
 H 1000 mm
 L 100 mm

Art. I325/8
 \varnothing 12 x 12 mm
 H 1000 mm
 L 100 mm

Art. I324/3
 \varnothing 12 x 12 mm
 H 1000 mm
 L 100 mm

Art. I324/4
 \varnothing 12 x 12 mm
 H 1000 mm
 L 100 mm

Art. I324/11
 \varnothing 12 x 12 mm
 H 1000 mm
 L 100 mm

Art. I324/12
 \varnothing 12 x 12 mm
 H 1000 mm
 L 100 mm

Art. I325/9
 \varnothing 12 x 12 mm
 H 1000 mm
 L 140 mm

Art. I325/10
 \varnothing 12 x 12 mm
 H 1000 mm
 L 140 mm

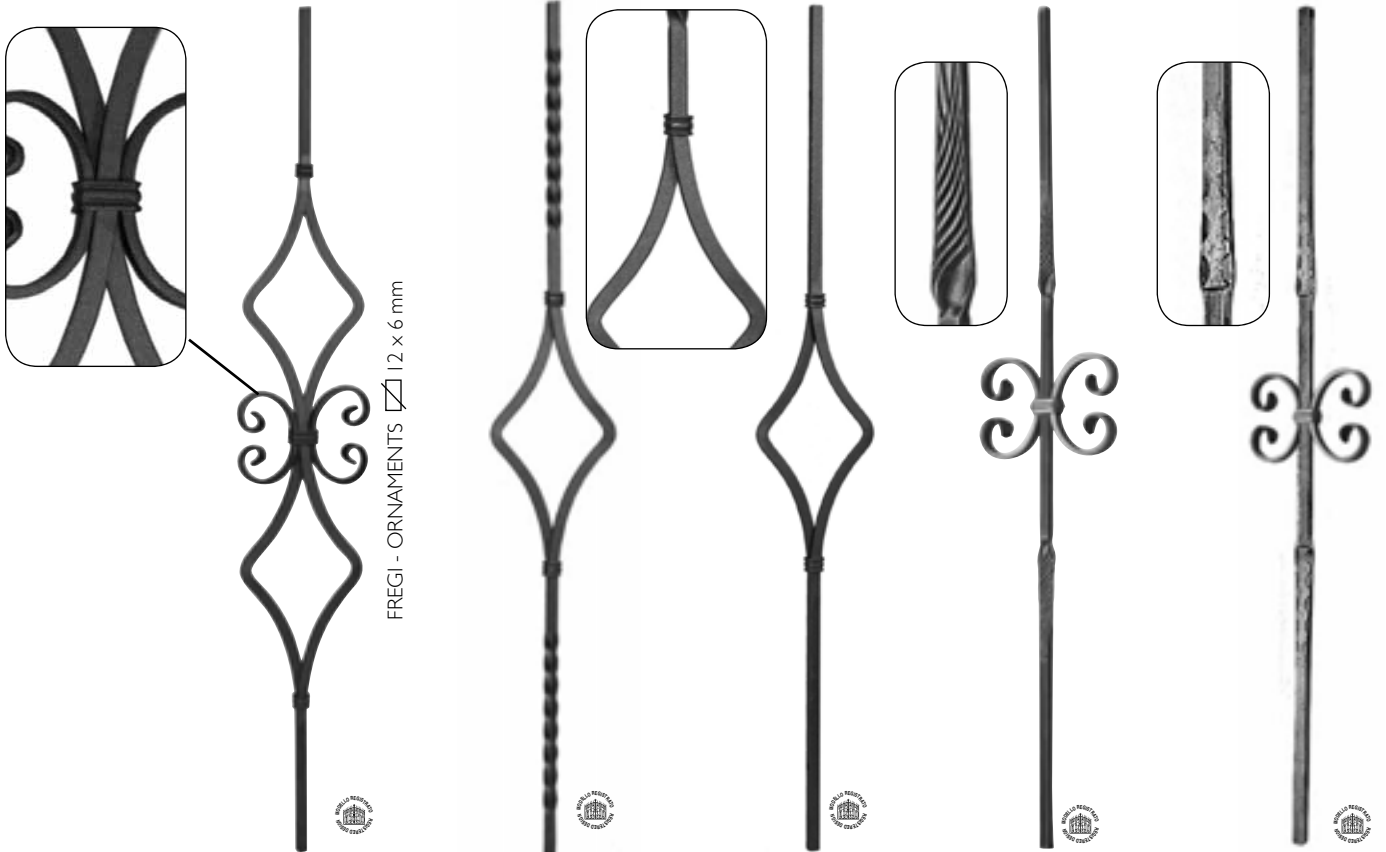

FREGI - ORNAMENTS \square 12 x 6 mm

Art. NEW0046
 Φ 12 x 12 mm
 H 1000 mm
 L 150 mm

Art. NEW0047
 Φ 12 x 12 mm
 H 1000 mm
 L 140 mm

Art. NEW0048
 Φ 12 x 12 mm
 H 1000 mm
 L 140 mm

Art. NEW0024
 Φ 12 x 12 mm
 H 1000 mm
 L 155 mm

Art. NEW0035
 Φ 12 x 12 mm
 H 1000 mm
 L 155 mm

Art. NEW0025
 Φ 14 x 14 mm
 H 1000 mm
 L 155 mm

Art. NEW0036
 Φ 14 x 14 mm
 H 1000 mm
 L 155 mm



ARTEFERRO



Art. GD73/3
 Φ 12 x 12 mm
 H 1000 mm
 L 440 mm



Art. GD73/2
 Φ 12 x 12 mm
 H 1000 mm
 L 112 mm

FREGI - ORNAMENTS \square 12 x 6 mm

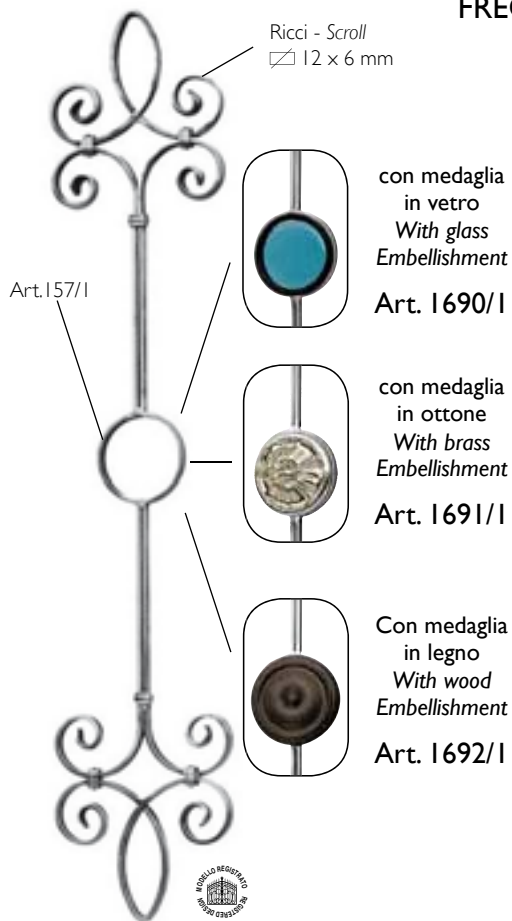

Art. 1688/5
 \square 12 x 12 mm
 H 1000 mm
 L 200 mm

Ricci - Scroll
 \square 12 x 6 mm

con medaglia
 in vetro
 With glass
 Embellishment
 Art. 1690/1



con medaglia
 in ottone
 With brass
 Embellishment
 Art. 1691/1



Con medaglia
 in legno
 With wood
 Embellishment
 Art. 1692/1

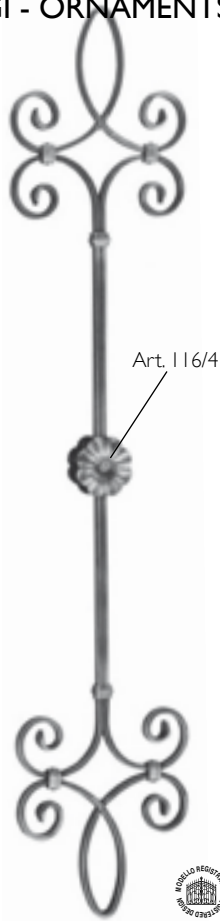

Art. 1688/6
 \square 12 x 6 mm
 H 1000 mm
 L 200 mm

Art. 116/4

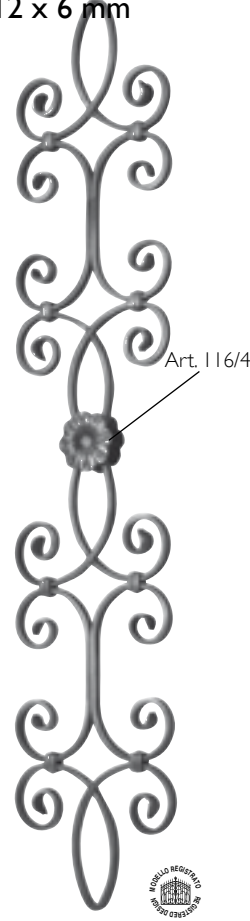

Art. GD35/1
 \square 12 x 6 mm
 H 1000 mm
 L 200 mm

Art. 116/4



Art. GD35/2
 \square 12 x 6 mm
 H 1000 mm
 L 200 mm



Art. GD35/3
 \square 12 x 6 mm
 H 1000 mm
 L 200 mm

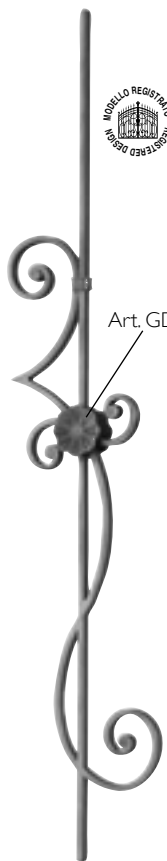

Art. GD239/4



Art. GD191/1
 □ 14 x 8 mm
 H 1000 mm
 L 210 mm

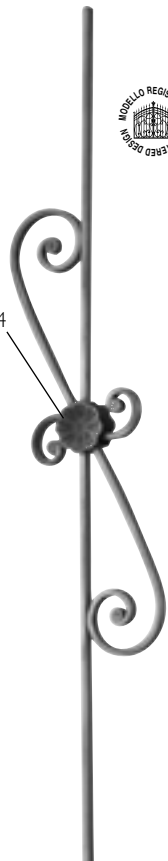

Art. GD191/2
 □ 14 x 8 mm
 H 1000 mm
 L 210 mm



Art. GD190/2
 Ø 14 mm
 H 1000 mm
 L 200 mm

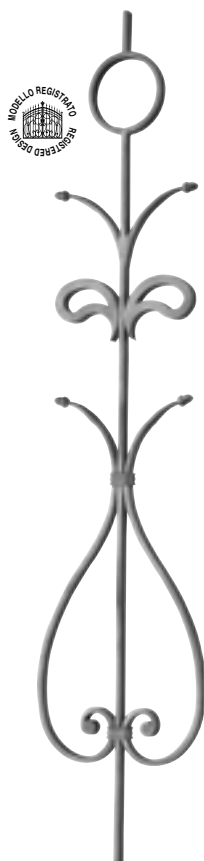

Art. GD192/1
 □ 14 x 8 mm
 H 1000 mm
 L 225 mm



Art. GD192/2
 □ 14 x 8 mm
 H 1000 mm
 L 190 mm



Art. GD68/2
 Φ 12 x 12 mm
 H 1000 mm
 L 100 mm



ARTEFERRO

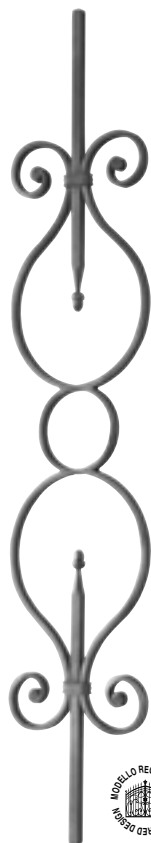

Art. GD190/1
 Φ 14 x 14 mm
 H 1000 mm
 L 205 mm



Art. GD171/1
 □ 14 x 8 mm
 H 1000 mm
 L 180 mm



Art. GD153/1
 □ 14 x 8 mm
 H 1000 mm
 L 190 mm



Art. GD20/3
 \varnothing 12 x 12 mm
 H 1000 mm
 L 180 mm



Art. GD20/4
 \varnothing 12 x 12 mm
 H 1000 mm
 L 200 mm



Art. GD20/5
 \varnothing 12 x 12 mm
 H 1000 mm
 L 180 mm



Art. GD20/6
 \varnothing 12 x 12 mm
 H 1000 mm
 L 100 mm



Art. GD20/7
 \varnothing 12 x 12 mm
 H 1000 mm
 L 100 mm

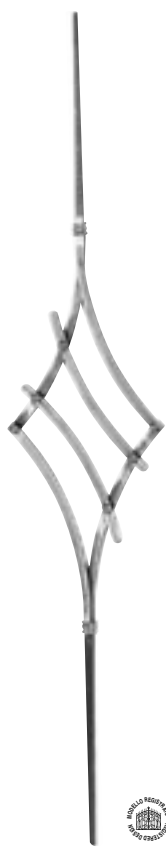

Art. GD20/8
 \varnothing 12 x 12 mm
 H 1000 mm
 L 200 mm

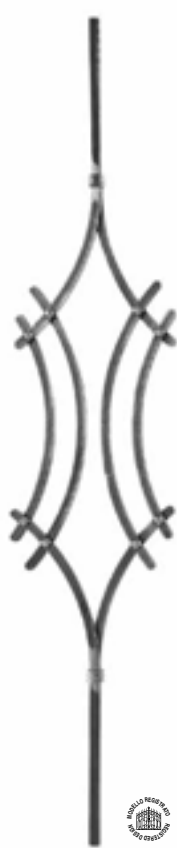

Art. GD21/3
 \varnothing 12 x 12 mm
 H 1000 mm
 L 200 mm



Art. GD21/4
 \varnothing 12 x 12 mm
 H 1000 mm
 L 180 mm



Art. GD21/5
 \varnothing 12 x 12 mm
 H 1000 mm
 L 200 mm



Art. GD21/6
 \varnothing 12 x 12 mm
 H 1000 mm
 L 200 mm

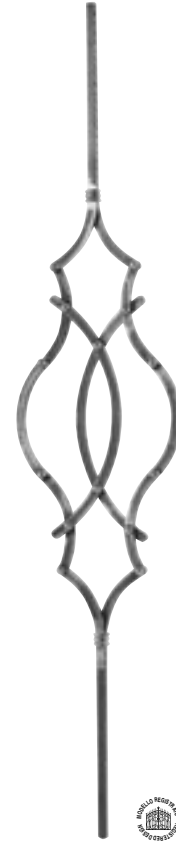

Art. GD21/7
 \varnothing 12 x 12 mm
 H 1000 mm
 L 200 mm

Rosette 116/A/4 sui due lati - Rosettes 116/A/4 on both sides



Art. 1685/3

Φ 14 x 14 mm

H 1000 mm - L 230 mm



Rosette 116/A/4 sui due lati - Rosettes 116/A/4 on both sides

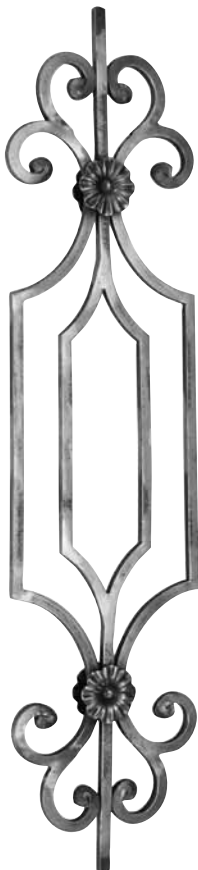

Art. GD22/1

Φ 14 x 14 mm

H 1000 mm - L 230 mm



ARTEFERRO



Art. GD22/2

Φ 14 x 14 mm

H 1000 mm

L 110 mm



Art. GD22/3

Φ 14 x 14 mm

H 1000 mm

L 110 mm



Art. GD22/4

Φ 14 x 14 mm

H 1000 mm

L 110 mm



Art. GD22/5

Φ 14 x 14 mm

H 1000 mm

L 200 mm



RICCI - SCROLLS \square 14 x 8 mm



Art. GDI69/3
 \square 14 x 8 mm
 H 1000 mm
 L 155 mm



Art. GDI50/1
 \square 14 x 8 mm
 H 1000 mm
 L 100 mm

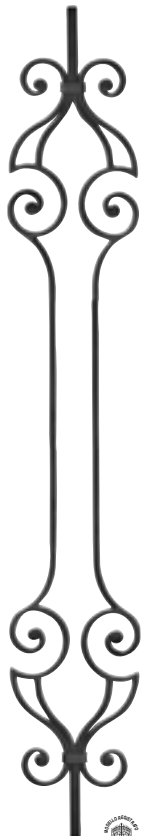

Art. GDI50/2
 Φ 14 x 14 mm
 H 1000 mm
 L 205 mm

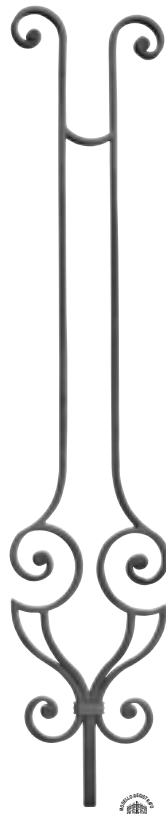

Art. GDI48/1
 Φ 14 x 14 mm
 H 1000 mm
 L 205 mm



Art. GDI50/3
 Φ 14 x 14 mm
 H 1000 mm
 L 190 mm

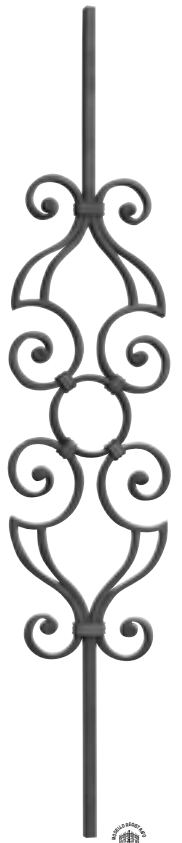

Art. GDI51/1
 Φ 14 x 14 mm
 H 1000 mm
 L 205 mm

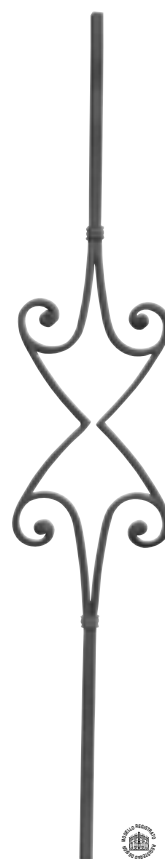

Art. GDI54/1
 Φ 14 x 14 mm
 H 1000 mm
 L 190 mm



Art. GDI54/2
 Φ 14 x 14 mm
 H 1000 mm
 L 190 mm

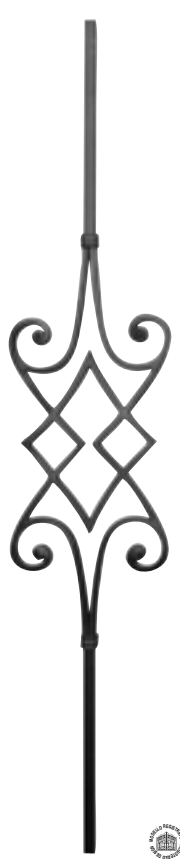

Art. GDI54/3
 Φ 14 x 14 mm
 H 1000 mm
 L 190 mm

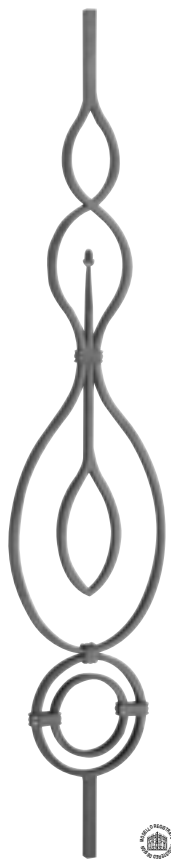

Art. GD177/1
 ▧ 14 x 8 mm
 H 1000 mm
 L 205 mm



Art. GD156/1
 ▧ 14 x 8 mm
 H 1000 mm
 L 80 mm



Art. GD156/2
 ▧ 14 x 8 mm
 H 1000 mm
 L 170 mm



Art. GD167/1
 ▧ 14 x 8 mm
 H 1000 mm
 L 150 mm

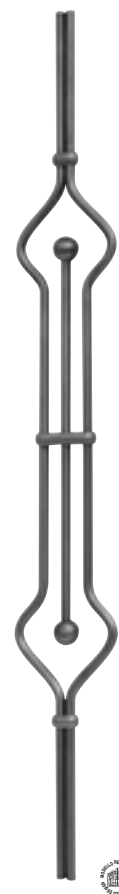

Art. GD192/3
 Ø 12 mm
 H 1000 mm
 L 130 mm

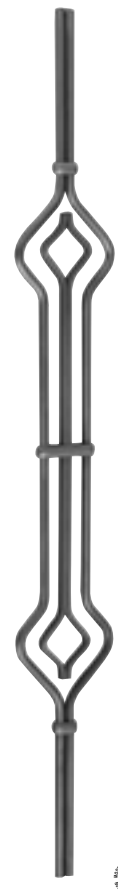

Art. GD193/1
 Ø 12 mm
 H 1000 mm
 L 130 mm



Art. GD170/1
 Ø 12 mm
 H 1000 mm
 L 130 mm



Art. GD170/2
 Ø 12 mm
 H 1000 mm
 L 170 mm



ARTEFERRO

PALETTI - PICKETS



Art. GDI58/1
 Ø 14 x 8 mm
 H 1000 mm
 L 160 mm



Art. GDI58/2
 Ø 14 x 8 mm
 H 1000 mm
 L 160 mm

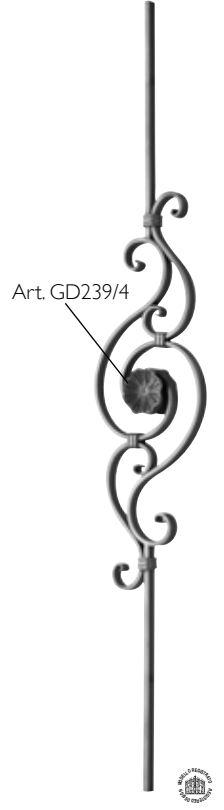

Art. NEW0017
 Ø 16 x 6 mm
 H 1000 mm
 L 175 mm

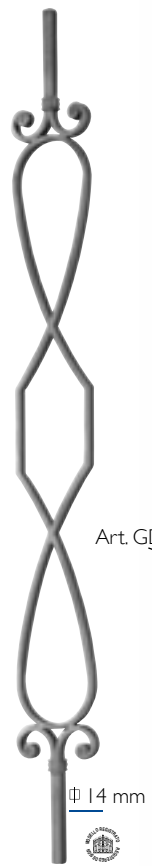

Art. GDI78/1
 Ø 14 x 8 mm
 H 1000 mm
 L 120 mm



Art. GDI78/2
 Ø 14 x 8 mm
 H 1000 mm
 L 200 mm



Art. GD228/2
 Ø 14 x 8 mm
 H 1000 mm
 L 190 mm

Ø 30 mm Ø 40 mm

Ricci - Scroll
12 x 6 mm

Ricci - Scroll
12 x 6 mm



Art. GD43/1 Ø 14 mm H 1000 mm	Art. 1170/3 Ø 12 mm H 1000 mm L 130 mm	Art. 1170/4 Ø 12 mm H 1000 mm L 130 mm	Art. 1171/1 Ø 12 mm H 1000 mm L 120 mm	Art. GDI76/1 14 x 14 mm H 1000 mm L 200 mm	Art. GDI76/2 14 x 14 mm H 1000 mm L 200 mm	Art. GDI76/3 14 x 14 mm H 1000 mm L 200 mm
--------------------------------------------	--------------------------------------------------------	--------------------------------------------------------	--------------------------------------------------------	------------------------------------------------------------	------------------------------------------------------------	------------------------------------------------------------



Art. 1171/2 Ø 12 mm H 1000 mm L 60 mm	Art. 1170/1 Ø 12 mm H 1000mm L 130 mm	Art. 1170/5 Ø 12 mm H 1000 mm L 70 mm	Art. 1170/6 Ø 12 mm H 1000 mm L 70 mm	Art. 1170/2 Ø 12 mm H 1000mm L 130 mm	Art. GD92/2 Ø 12 mm H 1000 mm L 130 mm	Art. GD92/3 Ø 12 mm H 1000 mm L 100 mm
-------------------------------------------------------	-------------------------------------------------------	-------------------------------------------------------	-------------------------------------------------------	-------------------------------------------------------	--------------------------------------------------------	--------------------------------------------------------



Art. 1160/4
 Ø 14 x 14 mm
 H 1200 mm
 L 170 mm



Art. 1160/3
 Ø 12 mm
 H 1200 mm



Art. 604/6
 Ø 12 mm
 H 1000 mm
Art. 604/1
 Ø 16 mm
 H 1000 mm



Art. 604/8
 Ø 12 mm
 H 1000 mm
Art. 604/3
 Ø 16 mm
 H 1000 mm



Art. 604/7
 Ø 12 mm
 H 1000 mm
Art. 604/2
 Ø 16 mm
 H 1000 mm

art. 604/2



ARTEFERRO



Ø 14 x 8 mm

Art. GD18/1
 Ø 14 x 14 mm
 H 1000 mm
 L 160 mm

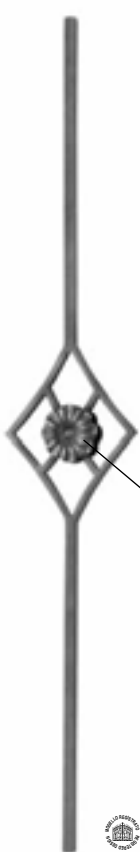

art. 116/A/4
 2 lati
 on two sides

Art. GD18/2
 Ø 14 x 14 mm
 H 1000 mm
 L 160 mm



art. 116/A/4
 2 lati
 on two sides

Art. GD18/4
 Ø 14 x 8 mm
 H 1000 mm
 L 115 mm



Art. 1680/1
 Ø 14 x 14 mm
 H 1000 mm
 L 130 mm



Art. GD19/1
 Ø 14 x 8 mm
 H 1000 mm
 L 100 mm



Art. GD19/2
 Ø 14 x 8 mm
 H 1000 mm
 L 100 mm



Art. GD19/4
 Ø 14 x 8 mm
 H 1000 mm
 L 100 mm



Art. 52/E/1
 Ø 12 x 12 mm
 H 900 mm
 L 180 mm



Art. 1051/2
 Ø 12 x 12 mm
 H 1000 mm
 L 150 mm



Art. 1051/3
 Ø 12 x 12 mm
 H 1000 mm
 L 150 mm



Art. 1049/1
 Ø 14 mm
 H 1000 mm
 L 260 mm



Art. 52/A/4
 Ø 12 x 12 mm
 H 900 mm
 L 250 mm





Art. 52/A/2
 Ø 12 x 12 mm
 H 900 mm
 L 230 mm

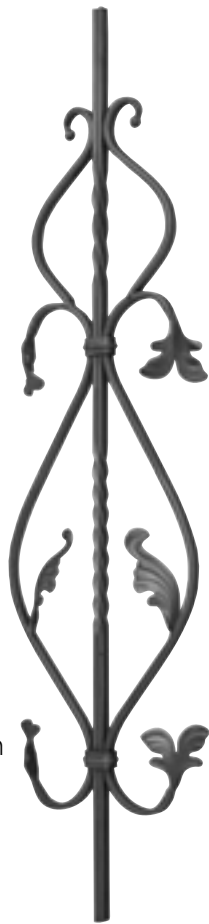

Art. 52/2
 Ø 12 x 12 mm
 H 900 mm
 L 235 mm

Art. 1753/7
 Ø 12 x 12 mm
 H 1000 mm
 L 235 mm



Art. 50/7
 Ø 12 x 12 mm
 H 900 mm
 L 140 mm

Art. 50/11
 Ø 14 x 14 mm
 H 900 mm
 L 142 mm

Art. 50/15
 Ø 16 x 16 mm
 H 900 mm
 L 144 mm



Art. 50/8
 Ø 12 x 12 mm
 H 900 mm
 L 140 mm

Art. 50/12
 Ø 14 x 14 mm
 H 900 mm
 L 142 mm

Art. 50/16
 Ø 16 x 16 mm
 H 900 mm
 L 144 mm



Art. 49/3
 Ø 12 x 12 mm
 H 900 mm
 L 180 mm

Art. 1753/1
 Ø 12 x 12 mm
 H 1000 mm
 L 180 mm

Art. 49/6
 Ø 12 x 12 mm
 H 1300 mm
 L 180 mm

Art. 49/5
 Ø 14 x 14 mm
 H 900 mm
 L 180 mm

Art. 49/7
 Ø 14 x 14 mm
 H 1300 mm
 L 180 mm



ARTEFERRO

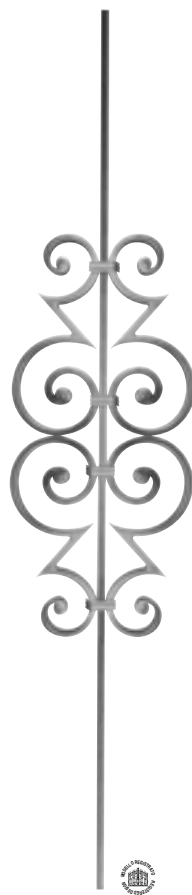

Art. GD200/1
 \square 14 x 8 mm
 H 1000 mm
 L 210 mm



Art. GD200/2
 \square 14 x 8 mm
 H 1000 mm
 L 108 mm

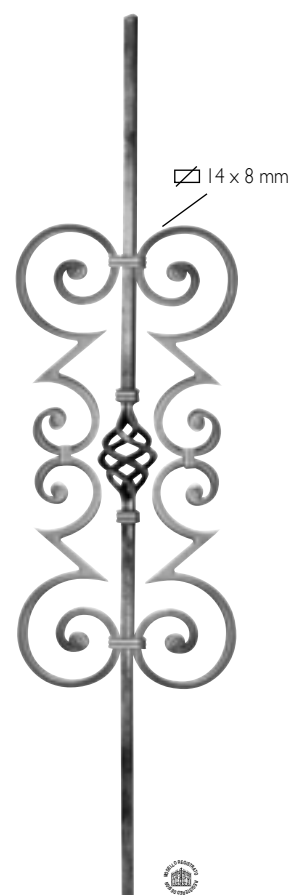

Art. GD200/3
 Φ 14 x 14 mm
 H 1000 mm
 L 215 mm

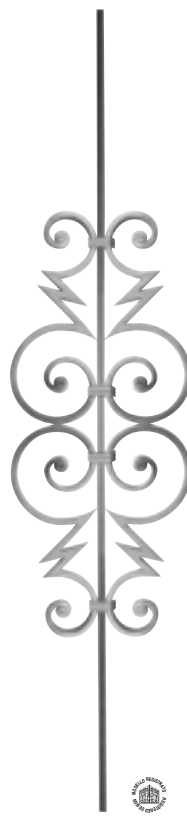

Art. GDI96/1
 \square 14 x 8 mm
 H 1000 mm
 L 210 mm





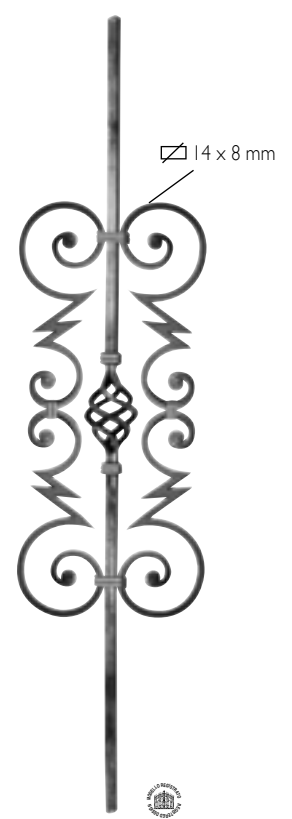



Art. GDI96/2
 \square 14 x 8 mm
 H 1000 mm
 L 108 mm

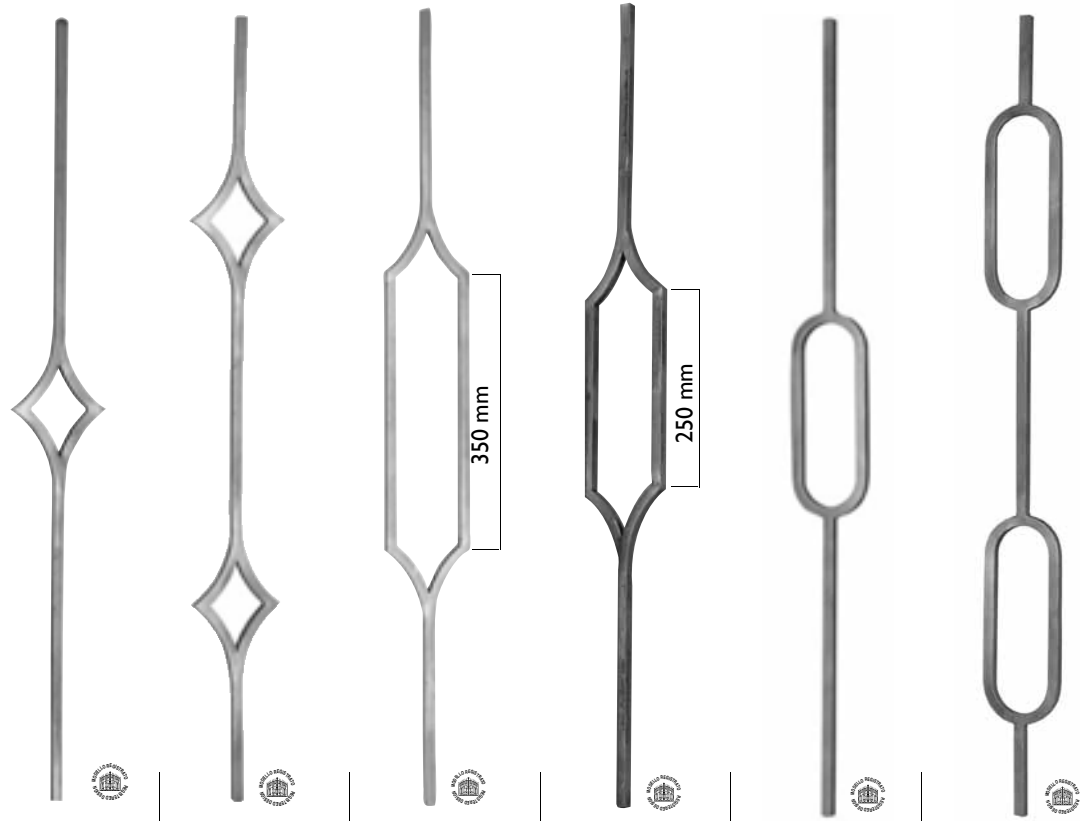

Art. GDI96/3
 Φ 14 x 14 mm
 H 1000 mm
 L 215 mm

ARTEFERRO



						
	L 120 mm H 1000 mm	L 120 mm H 1000 mm	L 110 mm H 1000 mm	L 110 mm H 1000 mm	L 100 mm H 1000 mm	L 100 mm H 1000 mm
Sez. / Sect.	Cod.art./Art.no.	Cod.art./Art.no.	Cod.art./Art.no.	Cod.art./Art.no.	Cod.art./Art.no.	Cod.art./Art.no.
Φ 12 x 12 mm	GD58/3	GD58/2	GD243/1	GD243/2	-	-
Φ 14 x 14 mm	GD23/1	GD25/1	GD25/2	GD25/3	GD29/1	GD29/2

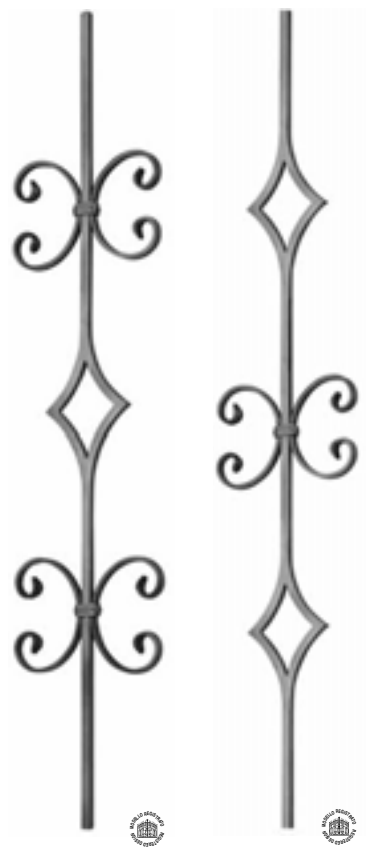

Art. **GD59/4**
 Φ 12 x 12 mm
 H 1000 mm
 L 200 mm

Art. **GD59/3**
 Φ 12 x 12 mm
 H 1000 mm
 L 200 mm



ARTEFERRO



Art. 1696/2

Ø 12 x 12 mm
H 1000 mm
L 75 mm



Art. 1696/1

Ø 12 x 12 mm
H 1000 mm
L 75 mm



Art. GD59/1

Ø 12 x 12 mm
H 1000 mm
L 70 mm



Art. GD59/2

Ø 12 x 12 mm
H 1000 mm
L 70 mm



Art. GD17/1

Ø 14 x 8 mm
H 1000 mm
L 65 mm

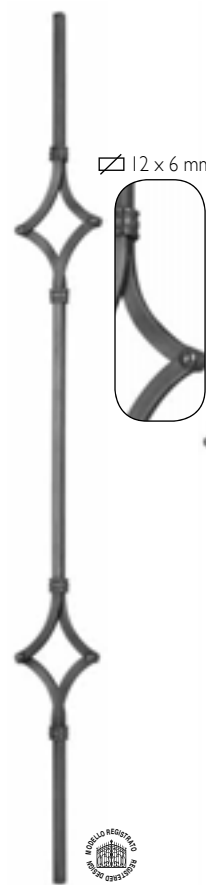

Art. GD20/2

Ø 12 x 12 mm
H 1000 mm
L 110 mm



Art. GD20/1

Ø 12 x 12 mm
H 1000 mm
L 110 mm



ARTEFERRO



Art. GD12/1

Ø 14 x 8 mm
H 1000 mm
L 95 mm



Art. GD41/1

Ø 12 mm
H 1000 mm
L 60 mm



Art. 1699/3

Ø 12 mm
H 1000 mm
L 60 mm



Art. GDI8/3

Ø 14 x 8 mm
H 1000 mm
L 85 mm



Art. GDI9/3

Ø 14 x 8 mm
H 1000 mm
L 85 mm

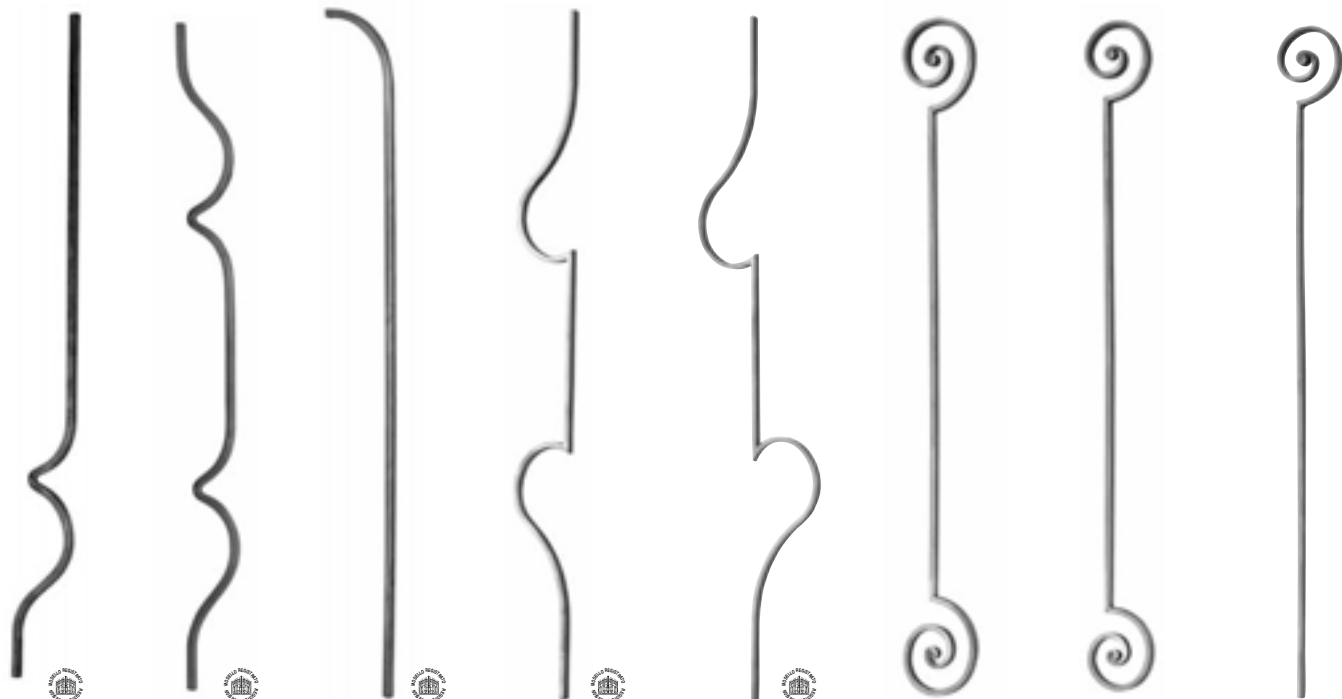

Art. 1097/3	Art. GD68/3	Art. GD73/2	Art. GD152/1	Art. GD152/2	Art. GD175/1	Art. GD175/2	Art. GD175/5
∅ 12 x 12 mm	∅ 12 x 12 mm	∅ 12 x 12 mm	∅ 14 x 8 mm	∅ 14 x 8 mm	∅ 14 x 8 mm	∅ 14 x 8 mm	∅ 14 x 8 mm
H 1000 mm	H 1000 mm	H 1000 mm	H 1000 mm	H 1000 mm	H 1000 mm	H 1000 mm	H 1000 mm
L 105 mm	L 105 mm	L 112 mm	L 95 mm	L 182 mm	L 115 mm	L 105 mm	L 105 mm

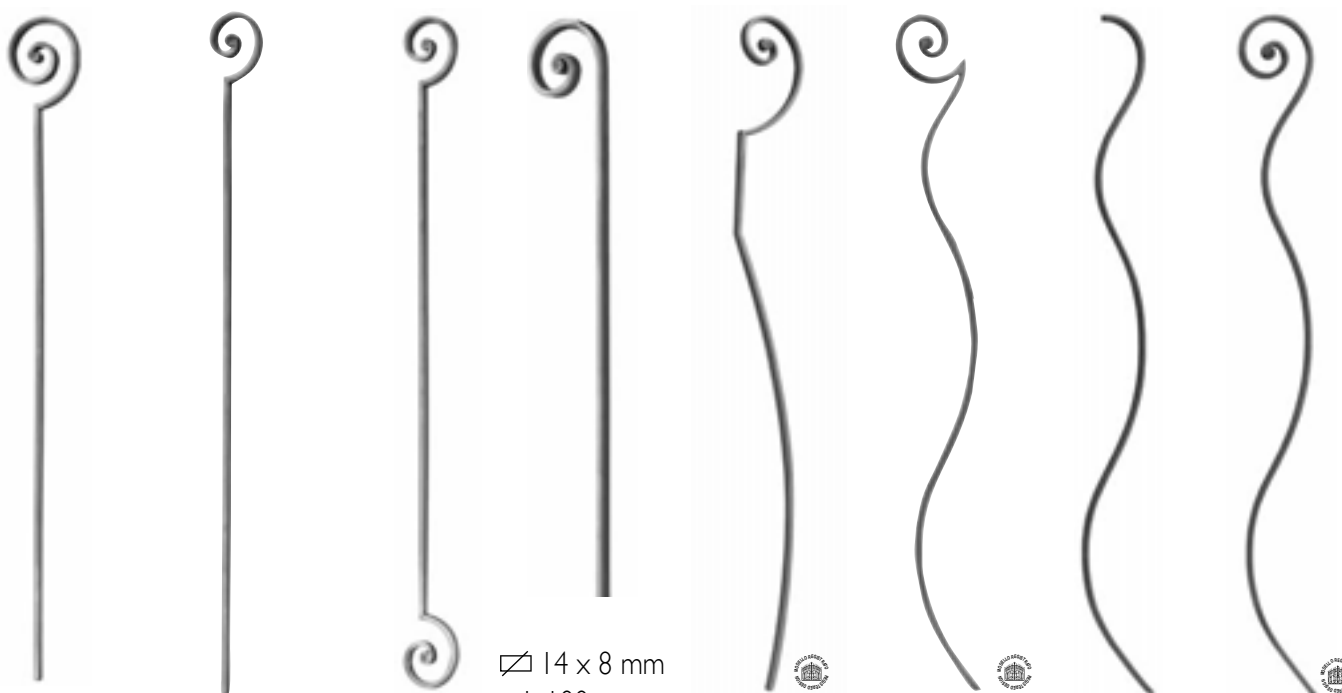

Art. GD175/4	Art. GD175/6	Art. GD175/3	Art. GD239/2	Art. GD215/2	Art. GD226/1	Art. GD226/2	Art. GD226/4
∅ 14 x 8 mm	∅ 14 x 8 mm	∅ 14 x 8 mm	∅ 14 x 8 mm	∅ 14 x 8 mm	∅ 14 x 8 mm	∅ 14 x 8 mm	∅ 14 x 8 mm
H 1000 mm	H 1000 mm	H 1000 mm	H 500 mm	H 1000 mm	H 1000 mm	H 1000 mm	H 1000 mm
L 115 mm	L 80 mm	L 80 mm	Art. GD239/3 H 1000 mm	L 110 mm	L 110 mm	L 110 mm	L 110 mm



ARTEFERRO

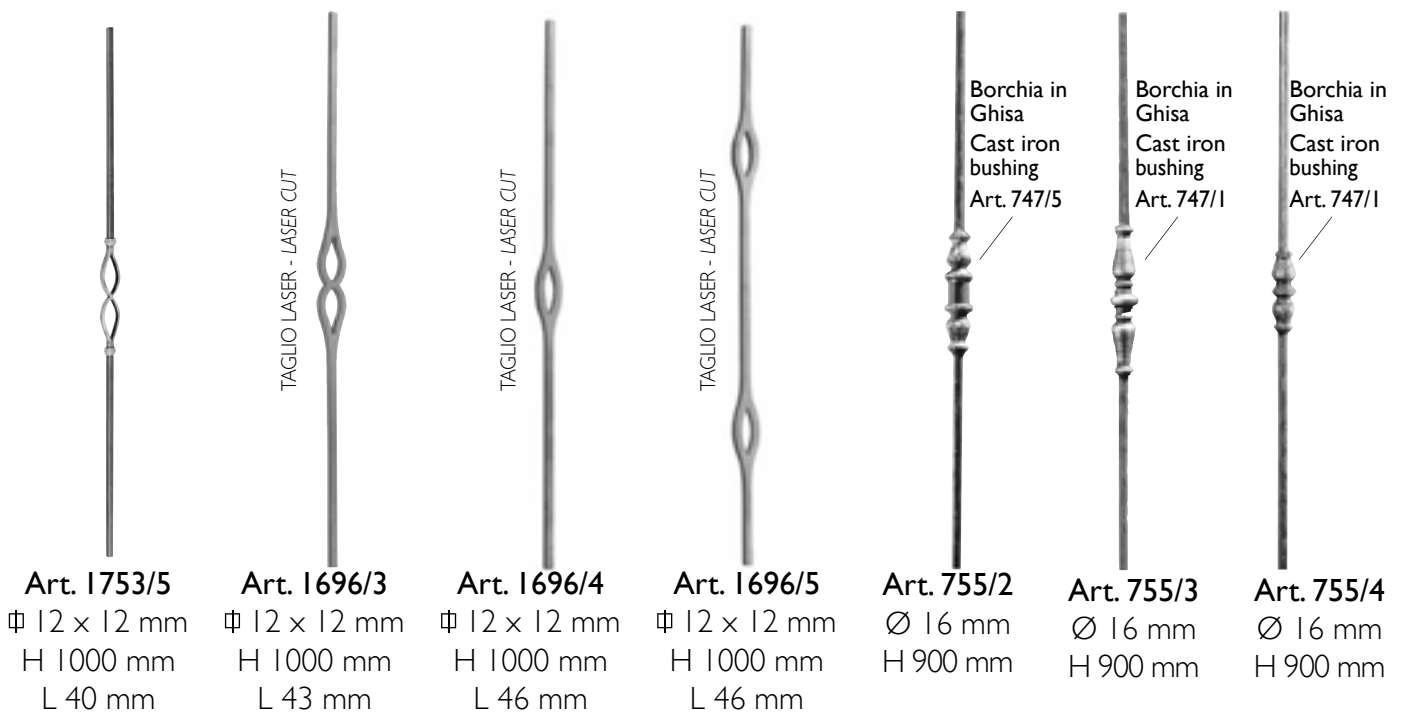
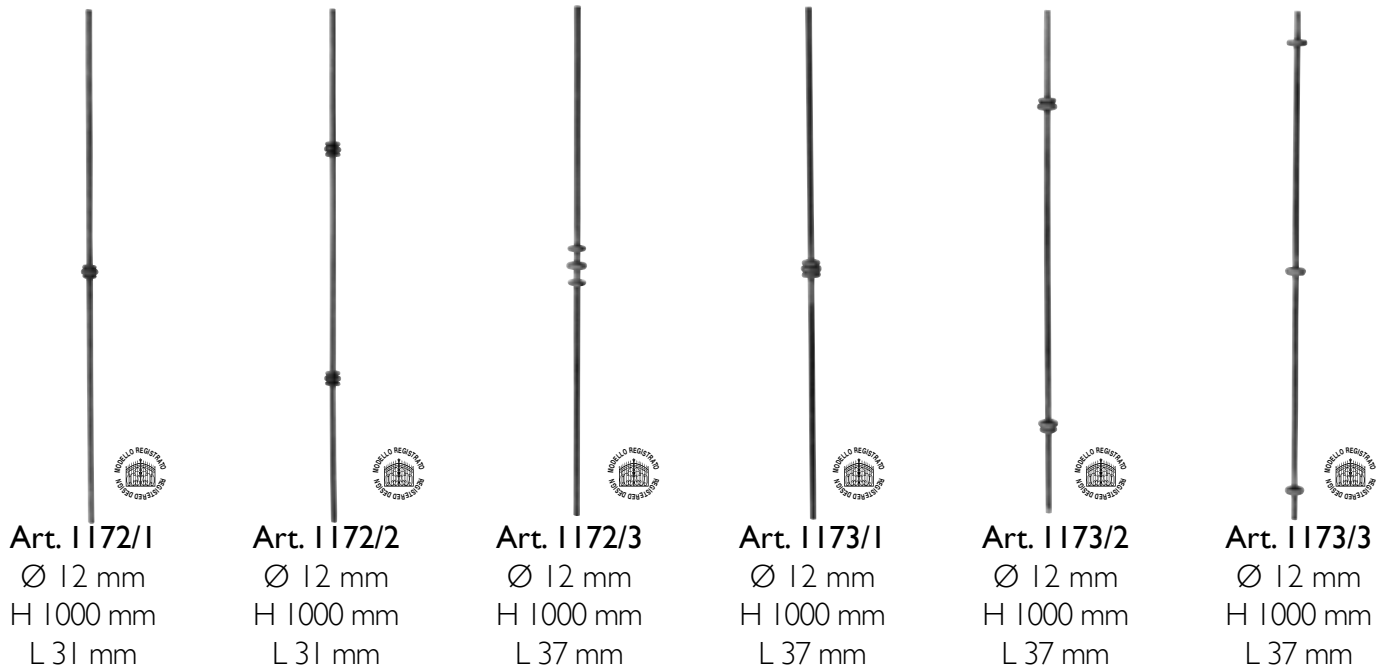
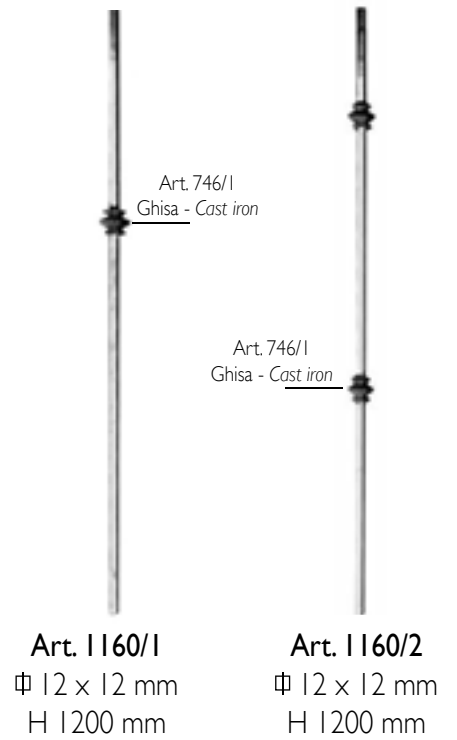

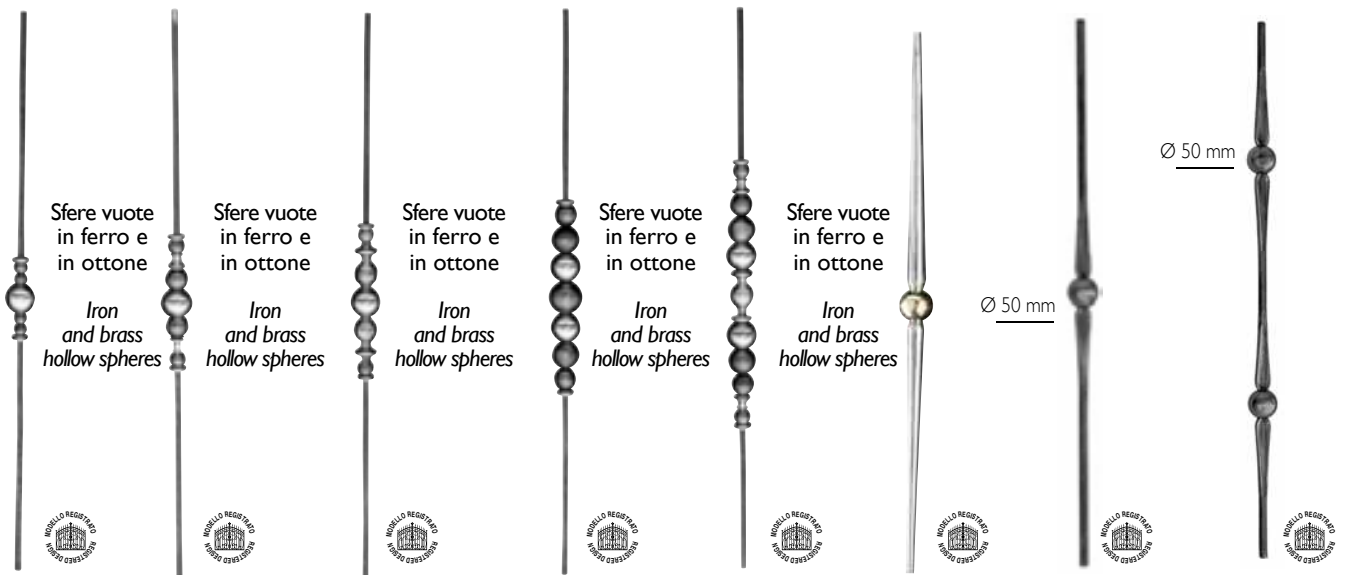

Art. 1211/1 Ø 12 mm H 1000 mm
 Art. 1211/2 Ø 12 mm H 1000 mm
 Art. 1211/3 Ø 12 mm H 1000 mm
 Art. 1211/4 Ø 12 mm H 1000 mm
 Art. 1211/5 Ø 12 mm H 1000 mm
 Art. 528/1 Ø 30 mm H 1000 mm
 Art. 1177/9 Ø 12 mm H 1000 mm
 Art. 1177/10 Ø 12 mm H 1000 mm

Paletto / Picket
 Ø 12 mm

Borchie in tubo
 Bushes from steel bushes

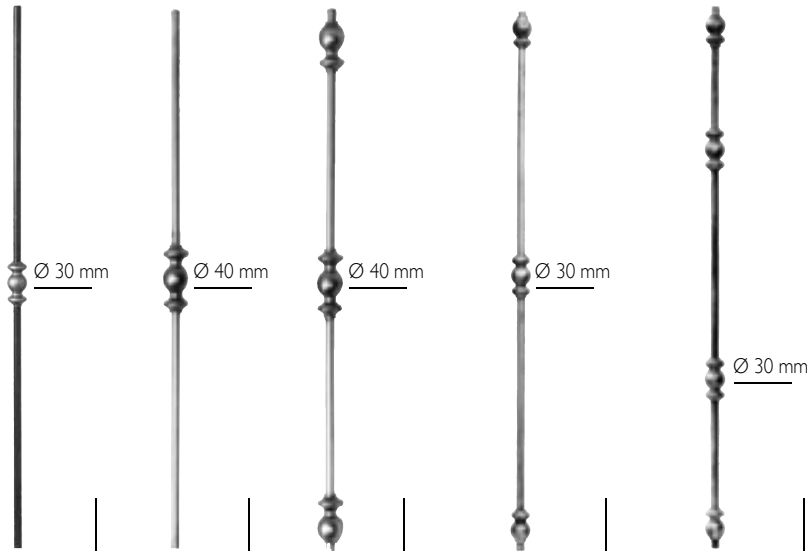

	Cod.art./Art.no.	Cod.art./Art.no.	Cod.art./Art.no.	Cod.art./Art.no.	Cod.art./Art.no.
H 720 mm	150/1	150/4	150/7	151/1	151/4
H 830 mm	150/2	150/5	150/8	151/2	151/5
H 900 mm	150/3	150/6	150/9	151/3	151/6

Art. 1177/11 Ø 14 mm H 1000 mm
 Art. 1177/12 Ø 14 mm H 1000 mm



Paletto / Picket
 Ø 12 mm

Borchie in tubo
 Bushes from steel bushes

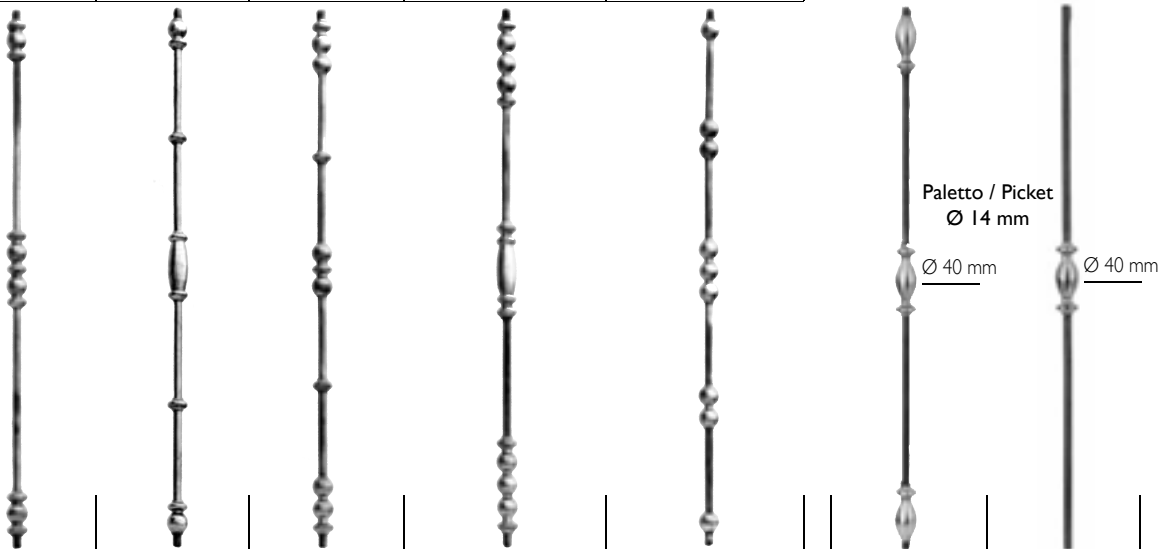

	Cod.art./Art.no.	Cod.art./Art.no.	Cod.art./Art.no.	Cod.art./Art.no.	Cod.art./Art.no.	Cod.art./Art.no.	Cod.art./Art.no.
H 720 mm	-	-	-	-	-	154/B/7	154/B/10
H 830 mm	154/6	154/8	154/10	154/12	154/14	154/B/8	154/B/11
H 900 mm	154/7	154/9	154/11	154/13	154/15	154/B/9	154/B/12

Borchie in tubo
Bushes from
steel bushes
Ø 30 mm



ARTEFERRO



Art. 1241/1 Ø 12 mm H 1000 mm
Art. 1241/2 Ø 12 mm H 1000 mm
Art. 1241/3 Ø 12 mm H 1000 mm
Art. 1241/4 Ø 12 mm H 1000 mm
Art. 1241/5 Ø 12 mm H 1000 mm
Art. 1241/6 Ø 12 mm H 1000 mm



Art. 1242/1 Ø 12 mm H 1000 mm
Art. 1242/2 Ø 12 mm H 1000 mm
Art. 1242/3 Ø 12 mm H 1000 mm
Art. 1242/4 Ø 12 mm H 1000 mm
Art. 1242/5 Ø 12 mm H 1000 mm
Art. 1242/6 Ø 12 mm H 1000 mm

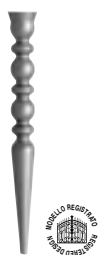

Art. 1223/4
Ø 30 mm
H 600 mm



Tubo liscio
Plain tube



Tubo rigato
Grooved tube



Art. 149/3
Ø 30 mm
H 400 mm

Sfera vuota
Hollow sphere
Ø 65 mm



Art. 1208/5
Ø 30 mm
H 900 mm

Sfera in vetro
Glass sphere

Colori disponibili
Colours available:

- Blu / Blue
- Giallo / Yellow
- Rosso / Red
- Verde / Green



Art. 531/1
Ø 50 mm
H 900 mm

Sfere vuote - Hollow spheres

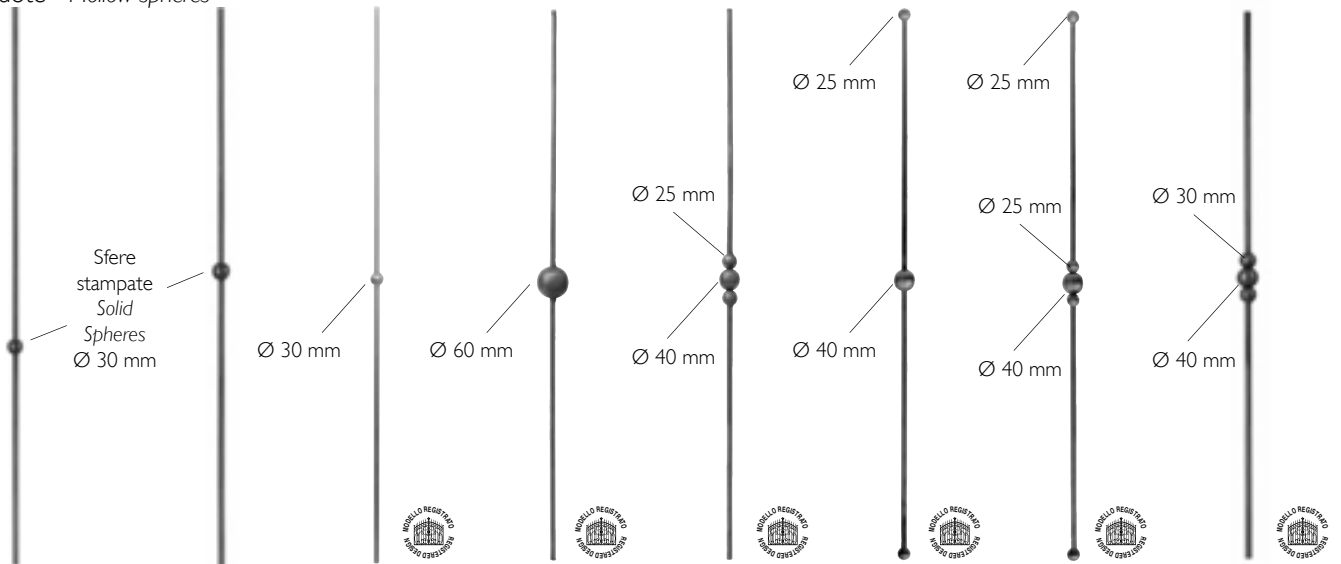

Art. GD247/2	Art. GD247/3	Art. GD92/1	Art. I208/1	Art. I208/2	Art. I208/3	Art. I208/4	Art. GD48/2
Ø 12 mm	Ø 12 mm	Ø 12 mm	Ø 12 mm	Ø 12 mm	Ø 12 mm	Ø 12 mm	Ø 12 mm
H 1000 mm	H 1000 mm	H 1000 mm	H 1000 mm	H 1000 mm	H 1200 mm	H 1000 mm	H 1000 mm

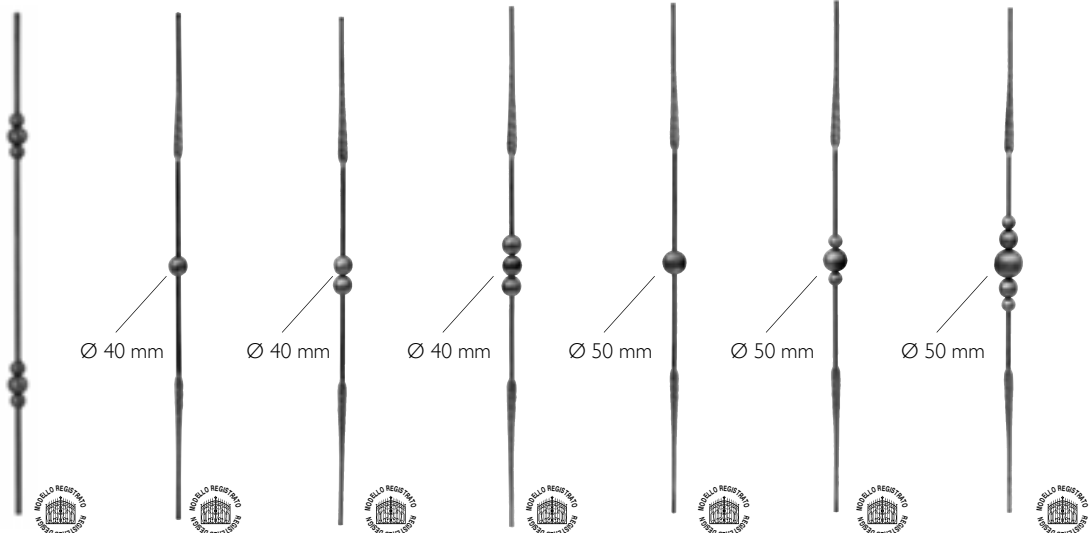

Art. GD48/1	Art. I210/1	Art. I210/2	Art. I210/3	Art. I210/4	Art. I210/5	Art. I210/6
Ø 12 mm	Ø 12 mm	Ø 12 mm	Ø 12 mm	Ø 12 mm	Ø 12 mm	Ø 12 mm
H 1000 mm	H 1000 mm	H 1000 mm	H 1000 mm	H 1000 mm	H 1000 mm	H 1000 mm



TUBO - TUBE

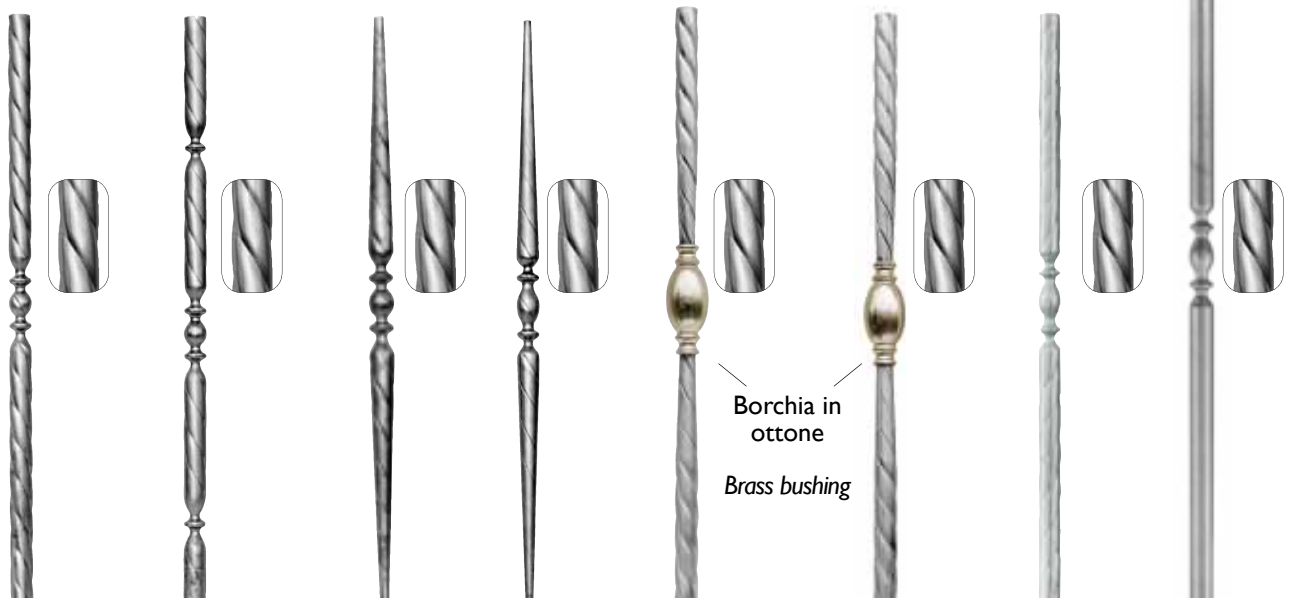

Art. I794/1	Art. I794/2	Art. I794/3	Art. I794/4	Art. I794/5	Art. I794/6	Art. I794/7	Art. I794/8
Ø 40 mm	Ø 40 mm	Ø 40 mm	Ø 40 mm	Ø 40 mm	Ø 40 mm	Ø 40 mm	Ø 40 mm
H 1000 mm	H 1000 mm	H 1000 mm	H 1000 mm	H 1000 mm	H 1000 mm	H 1000 mm	H 1200 mm



ARTEFERRO

Paletti in tubo d'acciaio con inserimento di bochie in ottone
Steel tube balusters with brass bushings

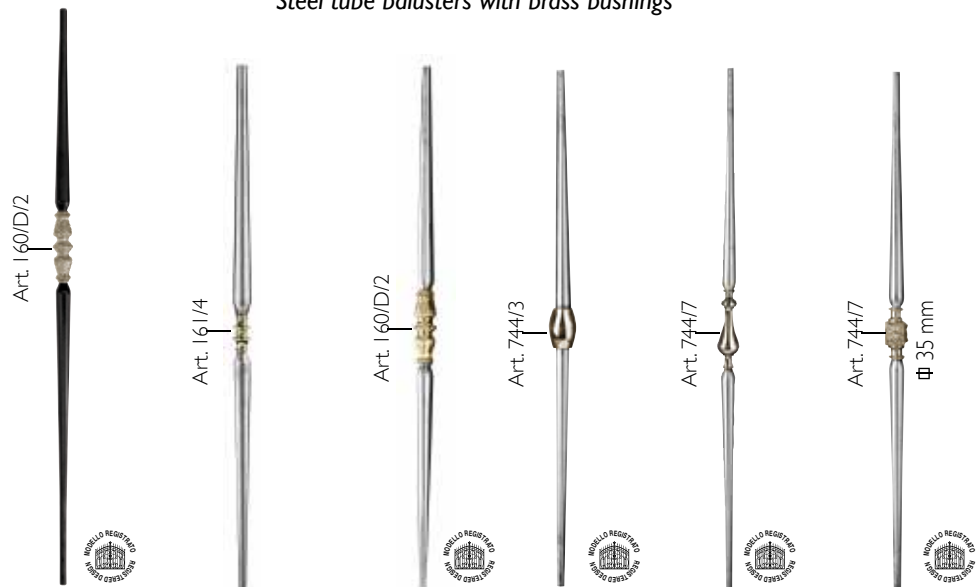

- Art. 160/D/2
Ø 30 mm
H 1200 mm
- Art. 161/4
Ø 30 mm
H 900 mm
- Art. 160/D/2
Ø 30 mm
H 930 mm
- Art. 744/3
Ø 50 mm
H 920 mm
- Art. 744/7
Ø 45 mm
H 1000 mm
- Art. 744/7
Ø 30 mm
H 1000 mm



- Art. 161/4
Ø 30 mm
H 900 mm
- Art. 161/4
Ø 30 mm
H 900 mm
- Art. 160/B/7
Ø 30 mm
H 900 mm
- Art. 160/B/7
Ø 30 mm
H 900 mm
- Art. 160/B/7
Ø 30 mm
H 900 mm
- Art. 744/8
Ø 30 mm
H 1000 mm

Borchia in legno / Wood bushing

Borchia in ceramica / Ceramic bushing
dipinta a mano / hand painted

Borchia in marmo / Marble bushing

Tubo di acciaio - Steel tube balusters Ø 30 mm

- Art. 745/2
Art. 530/1
Ø 46 mm
- Art. 745/3
Art. 530/2
Ø 52 mm
- Art. 745/4
Art. 530/3
Ø 57 mm
- Art. 745/5
Art. 530/4
Ø 30 mm

H 880 mm

Tubo di acciaio - Steel tube balusters Ø 30 mm

- Art. 533/5
Art. 533/1
Ø 55 mm
- Art. 533/6
Art. 533/2
Ø 55 mm
- Art. 533/7
Art. 533/3
Ø 55 mm
- Art. 533/8
Art. 533/4
Ø 30 mm

H 890 mm

Tubo di acciaio - Steel tube balusters Ø 30 mm

- Art. 535/4
Rosso / Red
Art. 535/1
Ø 55 mm
- Art. 535/5
Bianco / White
Art. 535/2
Ø 55 mm
- Art. 535/6
Nero / Black
Art. 535/3
Ø 30 mm

H 890 mm

Paletti in tubo - Tube balusters



Art. 146/3
Ø 40 mm
H 900 mm



Art. 146/4
Ø 40 mm
H 900 mm



Art. 147/1
Ø 40 mm
H 1000 mm



Art. 147/2
Ø 40 mm
H 1000 mm



Art. 148/1
Ø 30 mm
H 900 mm



Art. 1793/9
Ø 20 mm
H 1000 mm



Art. 148/2
Ø 30 mm
H 900 mm



Art. 536/1
Ø 30 mm
H 900 mm



Art. 536/2
Ø 30 mm
H 900 mm



Art. 536/3
Ø 40 mm
H 900 mm



Art. 536/4
Ø 40 mm
H 900 mm



Art. 1793/10
Ø 20 mm
H 500 mm

Art. 1793/11
Ø 20 mm
H 1000 mm



Art. 1793/1
Ø 50 mm
H 1000 mm



Art. 1793/2
Ø 50 mm
H 1000 mm



Art. 1793/3
Ø 50 mm
H 1000 mm



Art. 1793/4
Ø 50 mm
H 1000 mm



Art. 1793/5
Ø 40 mm
H 1000 mm



Art. 1793/6
Ø 40 mm
H 1200 mm



Art. 1157/7
Ø 30 mm
H 1200 mm



Art. 1157/8
Ø 30 mm
H 1200 mm



ARTEFERRO

Paletti in tubo - Tube balusters

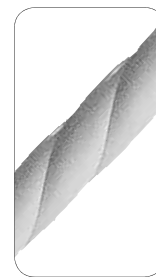

Tubo rigato
Grooved tube
Ø 30 mm

Art. 1229/1	Art. 1229/2	Art. 1229/3	Art. 1229/4	Art. 1229/5	Art. 1229/6	Art. 1229/7	Art. 1229/8
Ø 30 mm	Ø 30 mm	Ø 30 mm	Ø 30 mm	Ø 30 mm	Ø 30 mm	Ø 30 mm	Ø 30 mm
H 1000 mm	H 1000 mm	H 1000 mm	H 1000 mm	H 1000 mm	H 1000 mm	H 500 mm	H 500 mm

Art. 1230/1	Art. 1230/2	Art. 1230/3	Art. 1230/4	Art. 1231/1	Art. 1231/2	Art. 1231/3	Art. 1231/4
Ø 30 mm	Ø 30 mm	Ø 30 mm	Ø 30 mm	Ø 30 mm	Ø 30 mm	Ø 30 mm	Ø 30 mm
H 1000 mm	H 1000 mm	H 1000 mm	H 1000 mm	H 1000 mm	H 1000 mm	H 1000 mm	H 1000 mm

Borchia in Ottone Brass embellishment	Borchia in Ottone Brass embellishment	Borchia in Ottone Brass embellishment	Borchia in Ottone Brass embellishment	Borchia in Ottone Brass embellishment	Borchia in Ottone Brass embellishment	Borchia in Ottone Brass embellishment
Art. 744/4		Art. 744/7	Art. 744/8	Art. 744/3	Art. 744/1	Art. 161/4
Art. 1233/1	Art. 1233/2	Art. 1233/3	Art. 1233/4	Art. 1234/1	Art. 1234/2	Art. 1234/3
Ø 30 mm	Ø 30 mm	Ø 30 mm	Ø 30 mm	Ø 30 mm	Ø 30 mm	Ø 30 mm
H 1000 mm	H 1000 mm	H 1000 mm	H 1000 mm	H 900 mm	H 900 mm	H 900 mm

Paletti con borchia tornita saldata - Pickets with welded bushing

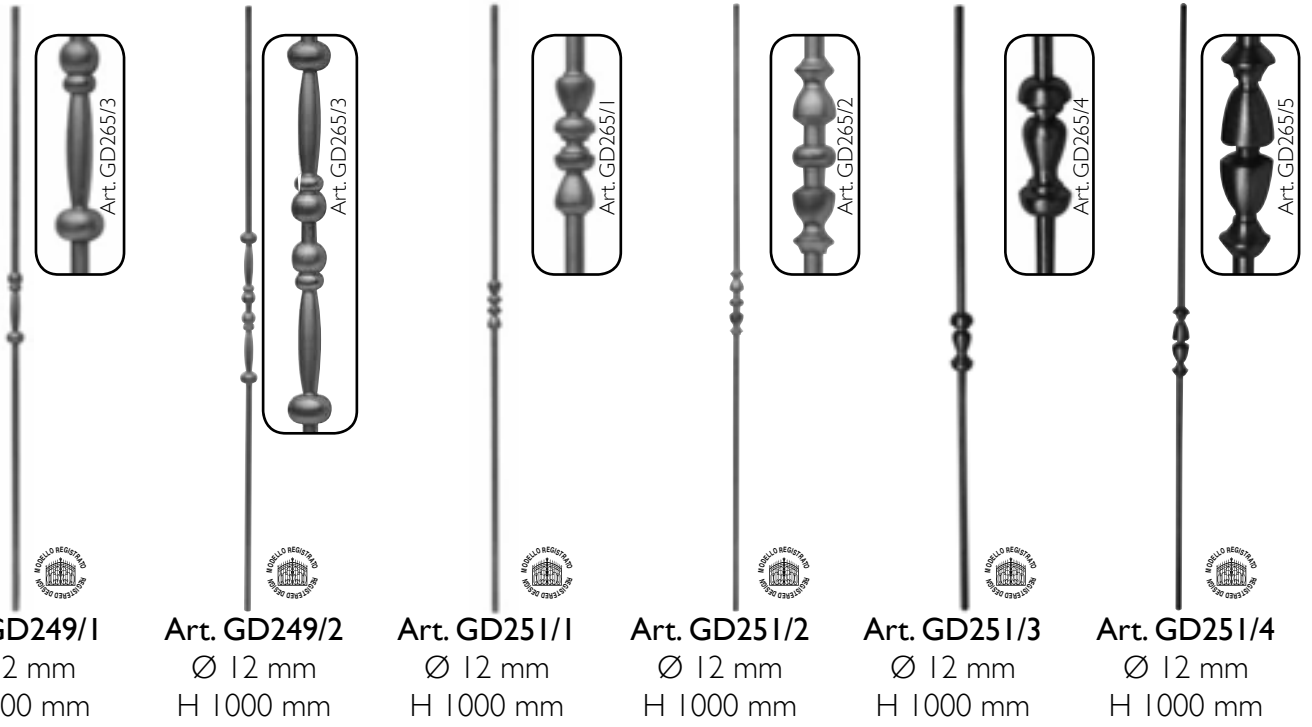

Art. GD249/1
Ø 12 mm
H 1000 mm

Art. GD249/2
Ø 12 mm
H 1000 mm

Art. GD251/1
Ø 12 mm
H 1000 mm

Art. GD251/2
Ø 12 mm
H 1000 mm

Art. GD251/3
Ø 12 mm
H 1000 mm

Art. GD251/4
Ø 12 mm
H 1000 mm



ARTEFERRO

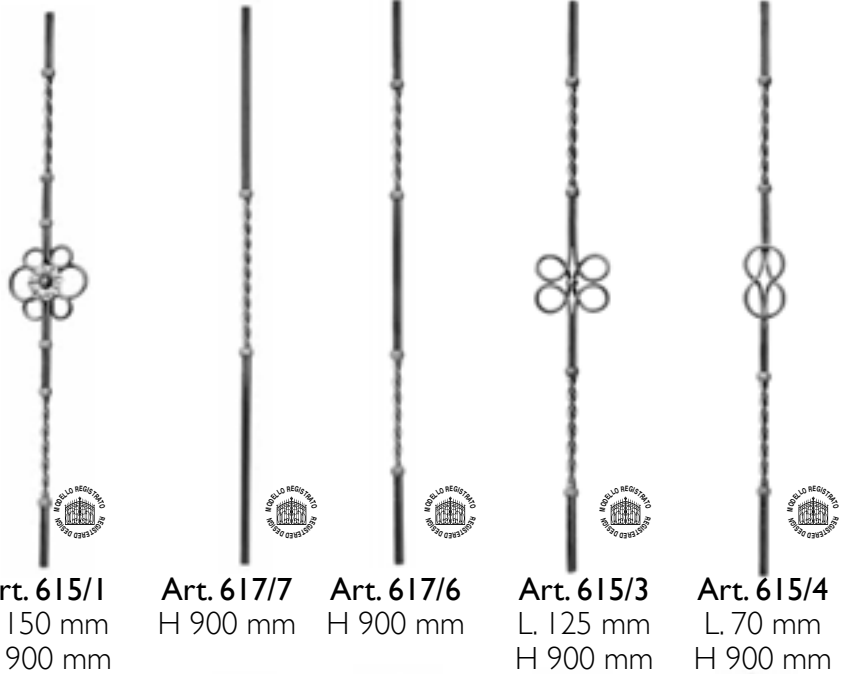

Art. 615/1
L 150 mm
H 900 mm

Art. 617/7
H 900 mm

Art. 617/6
H 900 mm

Art. 615/3
L 125 mm
H 900 mm

Art. 615/4
L 70 mm
H 900 mm

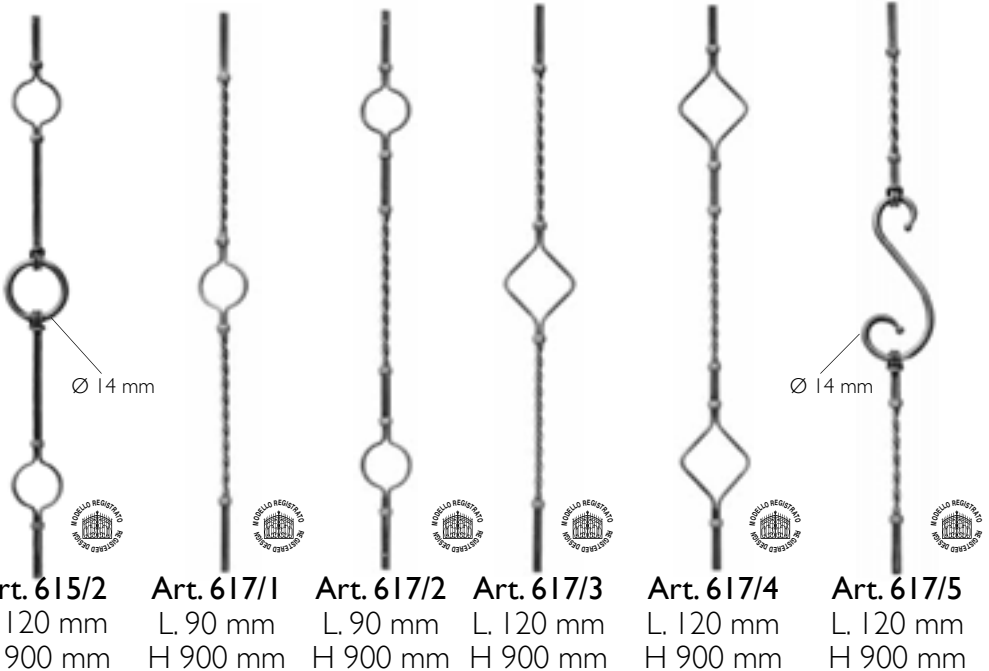
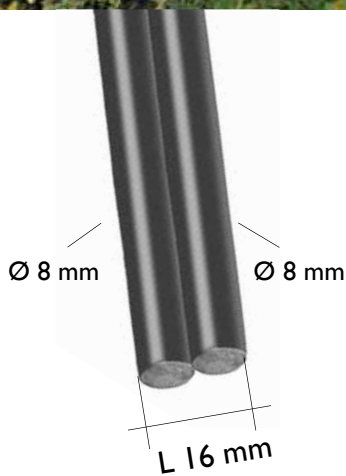

Art. 615/2
L 120 mm
H 900 mm

Art. 617/1
L 90 mm
H 900 mm

Art. 617/2
L 90 mm
H 900 mm

Art. 617/3
L 120 mm
H 900 mm

Art. 617/4
L 120 mm
H 900 mm

Art. 617/5
L 120 mm
H 900 mm

verniciato - painted



Art. 1490/1
Φ 12 x 12 mm
H 1120 mm

Art. 1490/2
Φ 12 x 12 mm
H 1200 mm

verniciato - painted



Art. 1490/3
Φ 12 x 12 mm
H 1120 mm

Art. 1490/4
Φ 12 x 12 mm
H 1200 mm



Art. 70/A/1
Φ 12 x 12 mm
H 900 mm
L 130 mm



Art. 70/A/2
Φ 12 x 12 mm
H 900 mm
L 130 mm



Art. 70/A/3
Φ 12 x 12 mm
H 1200 mm
L 130 mm

Art. 70/A/4
Φ 12 x 12 mm
H 1500 mm
L 130 mm



Art. 163/5
Φ 12 x 12 mm
H 530 mm

Art. 163/4
Φ 12 x 12 mm
H 1050 mm



Art. 1090/1
Φ 12 x 12 mm
H 1000 mm
L 115 mm



Art. 1090/3
Φ 12 x 12 mm
H 1000 mm
L 90 mm



Art. 1091/1
Φ 12 x 12 mm
H 1000 mm
L 135 mm



Art. 1093/1
medaglia in ottone
brass embellishment



Art. 1094/1
medaglia in legno
wood embellishment



Art. 1092/1
medaglia in vetro
glass embellishment



Art. 91/2
Φ 12 x 12 mm
H 655 mm

Art. 91/3
Φ 12 x 12 mm
H 735 mm



Art. 91/4
Φ 12 x 12 mm
H 470 mm

Art. 91/5
Φ 12 x 12 mm
H 530 mm



Art. 88/Q/1
Ø 20 x 4 mm
H 550 mm



Art. 1090/2
Φ 12 x 12 mm
H 1000 mm
L 115 mm



Art. 1090/4
Φ 12 x 12 mm
H 1000 mm
L 90 mm



Art. 1091/2
Φ 12 x 12 mm
H 1000 mm
L 135 mm



Art. 1093/2
2 medaglie in ottone
2 brass embellishment



Art. 1094/2
2 medaglie in legno
2 wood embellishment



Art. 1092/2
2 medaglie in vetro
2 glass embellishment



Art. 504/1
Ø 12 mm
H 1000 mm



Art. 1115/1
Φ 12 x 12 mm
H 1000 mm
L 105 mm



Art. 1115/2
Φ 12 x 12 mm
H 1000 mm
L 105 mm



Art. 529/7 Φ 20 × 20 mm H 1000 mm	Art. 529/6 Ø 14 mm H 900 mm	Art. 520/1 Ø 16 mm H 900 mm	Art. 520/2 Ø 16 mm H 900 mm	Art. 560/1 Ø 14 mm H 900 mm	Art. 560/2 Ø 14 mm H 900 mm	Art. 560/3 Ø 14 mm H 900 mm
------------------------------------------------	------------------------------------------	------------------------------------------	------------------------------------------	------------------------------------------	------------------------------------------	------------------------------------------

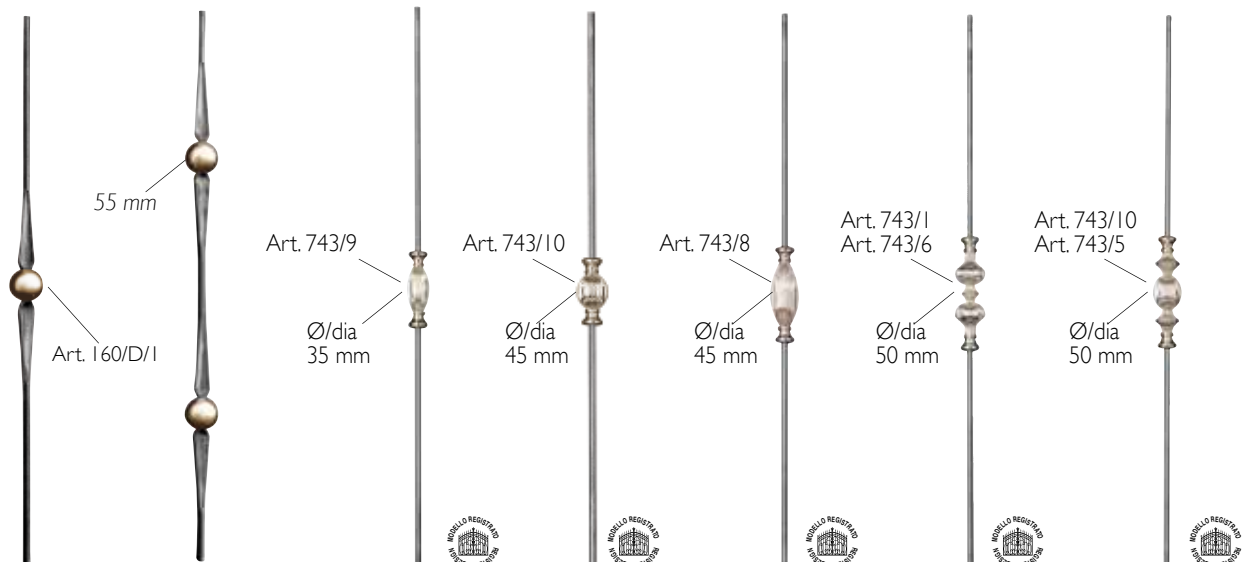

Art. 1179/5 Ø 12 mm H 1000 mm	Art. 1179/6 Ø 12 mm H 900 mm	Art. 522/1 Ø 10 mm H 900 mm	Art. 522/2 Ø 10 mm H 900 mm	Art. 522/3 Ø 10 mm H 900 mm	Art. 522/4 Ø 10 mm H 900 mm	Art. 522/5 Ø 10 mm H 900 mm
Art. 1179/7 Ø 14 mm H 1000 mm	Art. 1179/8 Ø 14 mm H 900 mm					

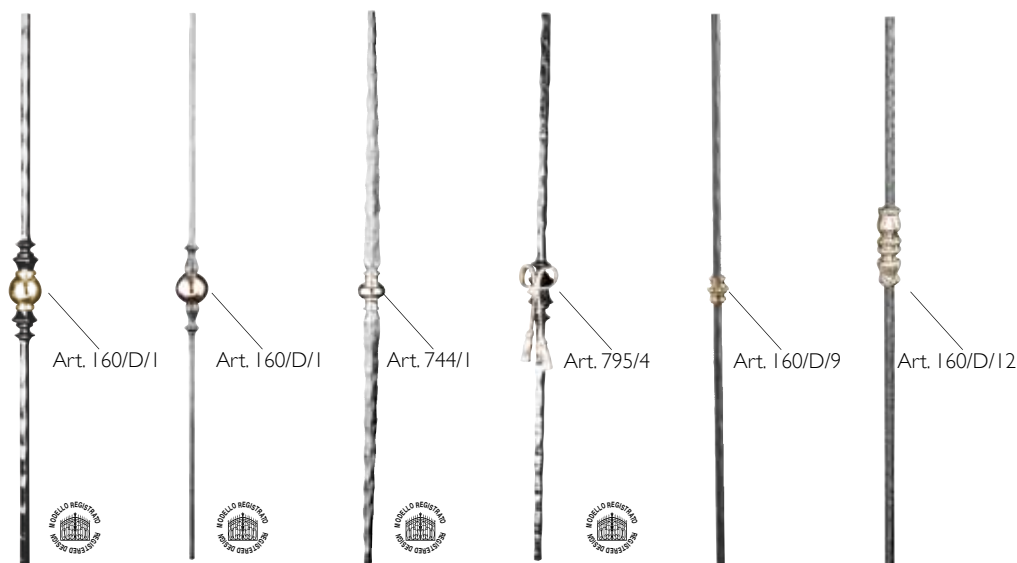

Art. 517/1 H 900 mm	Art. 518/1 H 900 mm	Art. 518/2 H 900 mm	Art. 518/3 H 900 mm	Art. 519/1 Ø 16 mm H 900 mm	Art. 521/1 Ø 16 mm H 900 mm
-------------------------------	-------------------------------	-------------------------------	-------------------------------	------------------------------------------	------------------------------------------



Art. 584/1
 Ø 12 x 12 mm
 H 900 mm
 L 210 mm



Art. 584/2
 Ø 12 x 12 mm
 H 900 mm
 L 210 mm



Art. 584/4
 Ø 12 x 12 mm
 H 900 mm
 L 165 mm



Art. 584/5
 Ø 12 x 12 mm
 H 900 mm
 L 165 mm



Art. 584/6
 Ø 12 x 12 mm
 H 900 mm
 L 165 mm



Art. 584/7
 Ø 12 x 12 mm
 H 900 mm
 L 165 mm



Art. 1067/3
 Ø 12 mm
 H 1000 mm
 L 175 mm



Art. 1067/4
 Ø 12 mm
 H 1000 mm
 L 175 mm



Art. 1066/1
 Ø 12 mm
 H 1000 mm
 L 175 mm



Art. 1066/2
 Ø 12 mm
 H 1000 mm
 L 175 mm



Art. 1069/1
 14 x 14 mm
 H 1000 mm
 L 175 mm



Art. 1069/2
 12 x 12 mm
 H 1000 mm
 L 175 mm



Art. 1068/1
 Ø 12 mm
 H 1000 mm
 L 175 mm



Art. 1068/2
 Ø 12 mm
 H 1000 mm
 L 175 mm



Art. 1068/3
 Ø 12 mm
 H 1000 mm
 L 175 mm



Art. 1068/4
 Ø 12 mm
 H 1000 mm
 L 175 mm

Art. 1243/4

Art. 1243/11

Art. 1243/10

Art. 1243/9



Art. 134/B/1
 ∅ 12 x 6 mm
 H 900 mm
Art. 134/B/2
 ∅ 12 x 12 mm
 H 900 mm



Art. 134/B/3
 ∅ 12 x 6 mm
 H 900 mm
Art. 134/B/4
 ∅ 12 x 12 mm
 H 900 mm

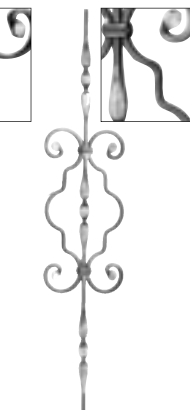

Art. 134/B/5
 ∅ 12 x 6 mm
 H 900 mm
Art. 134/B/6
 ∅ 12 x 12 mm
 H 900 mm

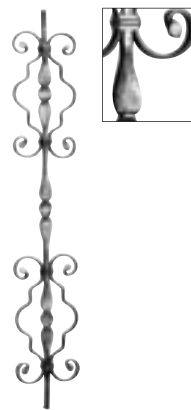

Art. 134/D/1
 ∅ 12 x 6 mm
 H 900 mm
Art. 134/D/2
 ∅ 12 x 12 mm
 H 900 mm
Art. 134/D/3
 ∅ 12 x 12 mm
 H 1200 mm



Art. 134/D/4
 ∅ 12 x 6 mm
 H 900 mm
Art. 134/D/5
 ∅ 12 x 12 mm
 H 900 mm
Art. 134/D/6
 ∅ 12 x 12 mm
 H 1200 mm



Art. 134/C/1
 ∅ 12 x 6 mm
 H 900 mm
Art. 134/C/2
 ∅ 12 x 12 mm
 H 900 mm
Art. 134/C/3
 ∅ 12 x 12 mm
 H 1200 mm

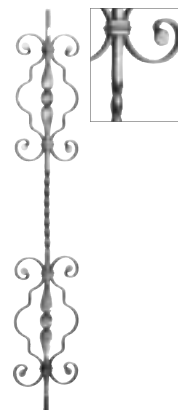

Art. 134/C/4
 ∅ 12 x 6 mm
 H 900 mm
Art. 134/C/5
 ∅ 12 x 12 mm
 H 900 mm
Art. 134/C/6
 ∅ 12 x 12 mm
 H 1200 mm



Art. 1127/1
 ∅ 12 x 12 mm
 H 1000 mm
 L 160 mm

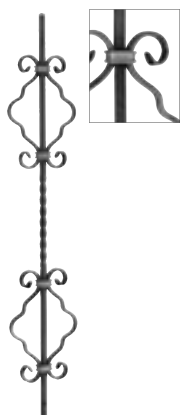

Art. 1127/2
 ∅ 12 x 12 mm
 H 1000 mm
 L 160 mm



Art. 1716/9
 ∅ 12 mm
 H 1000 mm
 L 175 mm
Art. 1716/10
 ∅ 14 mm
 H 1000 mm
 L 175 mm



Art. 1716/21
 ∅ 12 mm
 H 1000 mm
 L 170 mm
Art. 1716/22
 ∅ 14 mm
 H 1000 mm
 L 170 mm



Art. 1710/11
 ∅ 12 x 12 mm
 H 1000 mm
 L 160 mm
Art. 1710/12
 ∅ 14 x 14 mm
 H 1000 mm
 L 160 mm



Art. 1710/23
 ∅ 12 x 12 mm
 H 1000 mm
 L 160 mm
Art. 1710/24
 ∅ 14 x 14 mm
 H 1000 mm
 L 160 mm

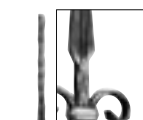

Art. 1707/9
 ∅ 12 x 12 mm
 H 1000 mm
 L 160 mm
Art. 1707/12
 ∅ 14 x 14 mm
 H 1000 mm
 L 160 mm



ARTEFERRO



Art. 1713/11
 ∅ 12 x 12 mm
 H 1000 mm
 L 160 mm
Art. 1713/12
 ∅ 14 x 14 mm
 H 1000 mm
 L 160 mm



Art. 1709/23
 ∅ 12 x 12 mm
 H 1000 mm
 L 160 mm
Art. 1709/24
 ∅ 14 x 14 mm
 H 1000 mm
 L 160 mm



Art. 1138/1
 ∅ 12 x 12 mm
 H 1000 mm
 L 110 mm
Art. 1138/2
 ∅ 14 x 14 mm
 H 1000 mm
 L 110 mm



Art. 1709/11
 ∅ 12 x 12 mm
 H 1000 mm
 L 160 mm
Art. 1709/12
 ∅ 14 x 14 mm
 H 1000 mm
 L 160 mm

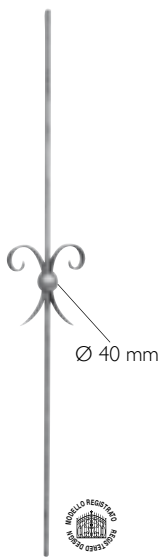

Art. 1060/1
 Ø 12 mm
 H 1000 mm
 L 165 mm

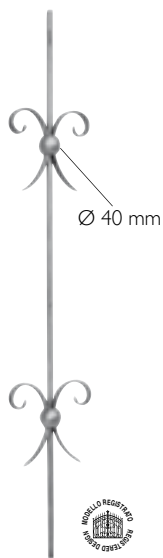

Art. 1060/2
 Ø 12 mm
 H 1000 mm
 L 165 mm

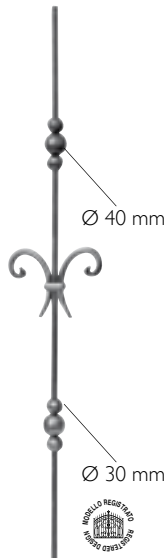

Art. 1064/4
 Ø 12 mm
 H 1000 mm
 L 180 mm



Art. 1064/5
 Ø 12 mm
 H 1000 mm
 L 180 mm



Art. 1064/6
 Ø 12 mm
 H 1000 mm
 L 180 mm

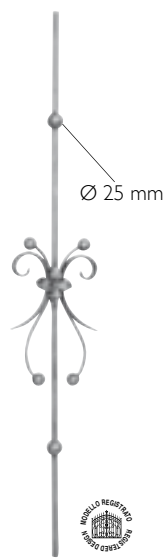

Art. 1060/3
 Ø 12 mm
 H 1000 mm
 L 190 mm



Art. 1060/4
 Ø 12 mm
 H 1000 mm
 L 190 mm

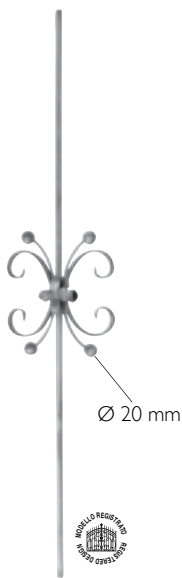

Art. 1061/1
 Ø 12 mm
 H 1000 mm
 L 205 mm



Art. 1061/2
 Ø 12 mm
 H 1000 mm
 L 205 mm

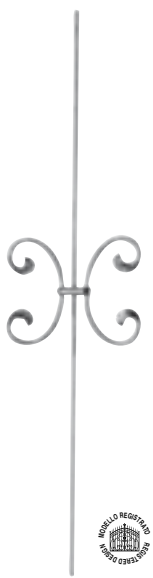

Art. 1073/1
 Ø 10 mm
 H 1000 mm
 L 240 mm



Art. 1073/2
 Ø 10 mm
 H 1000 mm
 L 240 mm



Art. 134/E/2
 Ø 15 x 8 mm
 H 900 mm
 L 155 mm



Art. 134/E/3
 Ø 15 x 8 mm
 H 900 mm
 L 155 mm



Art. 1130/1
 Ø 14 x 14 mm
 H 1000 mm
 L 175 mm



Art. 1130/2
 Ø 14 x 14 mm
 H 1000 mm
 L 175 mm



Art. 1064/1
 Ø 12 mm
 H 1000 mm
 L 175 mm

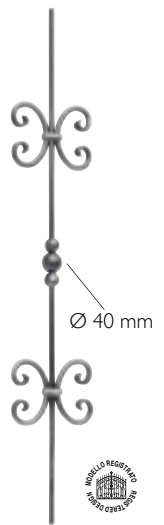

Art. 1064/2
 Ø 12 mm
 H 1000 mm
 L 175 mm



Art. 1064/3
 Ø 12 mm
 H 1000 mm
 L 200 mm

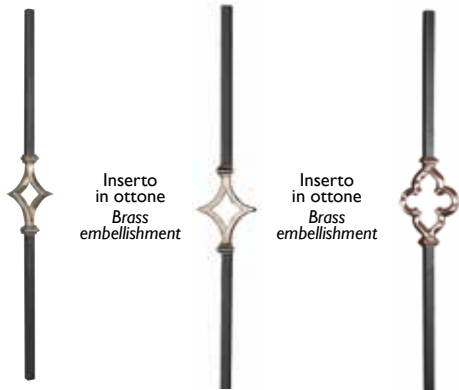

Inserto
in ottone
Brass
embellishment

Inserto
in ottone
Brass
embellishment

Art. 160/C/1
Ø 20 x 20 mm
H 900 mm
L 130 mm

Art. 160/C/2
Ø 20 x 20 mm
H 900 mm
L 130 mm

Art. 160/C/3
Ø 20 x 20 mm
H 900 mm
L 155 mm



Inserto
in ottone
Brass
embellishment



Inserto
in ottone
Brass
embellishment



Art. 160/C/4
Ø 20 x 20 mm
H 300 mm
L 130 mm

Art. 160/C/5
Ø 20 x 20 mm
H 300 mm
L 130 mm

Art. 160/C/6
Ø 20 x 20 mm
H 300 mm
L 155 mm



ARTEFERRO

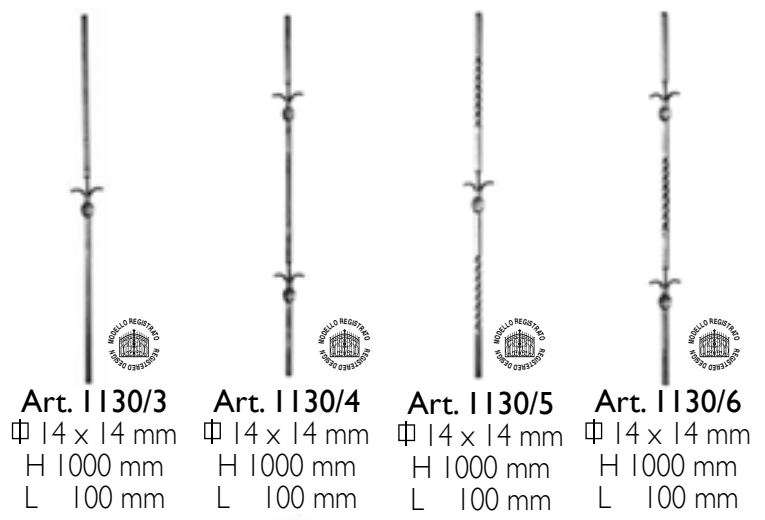

Art. 1130/3
Ø 14 x 14 mm
H 1000 mm
L 100 mm

Art. 1130/4
Ø 14 x 14 mm
H 1000 mm
L 100 mm

Art. 1130/5
Ø 14 x 14 mm
H 1000 mm
L 100 mm

Art. 1130/6
Ø 14 x 14 mm
H 1000 mm
L 100 mm



MODELLO REGISTRATO
IN UNO DEI PAESI
MARCHI ARTEFERRO

Art. 1699/1
Ø 12 mm
H 1000 mm
L 80 mm



MODELLO REGISTRATO
IN UNO DEI PAESI
MARCHI ARTEFERRO

Art. 1699/2
Ø 12 mm
H 1000 mm
L 80 mm



MODELLO REGISTRATO
IN UNO DEI PAESI
MARCHI ARTEFERRO

Art. 1056/4
Ø 12 x 12 mm
H 1000 mm
L 125 mm



Art. 61/3
liscio/plain
Ø 40 x 4 mm
H 900 mm
L 125 mm
Art. 61/4
martellato
hammered
Ø 40 x 4 mm
H 900 mm
L 125 mm



MODELLO REGISTRATO
IN UNO DEI PAESI
MARCHI ARTEFERRO

Art. 1699/6
Ø 12 mm
H 1000 mm
L 150 mm



MODELLO REGISTRATO
IN UNO DEI PAESI
MARCHI ARTEFERRO

Art. 1699/7
Ø 12 mm
H 1000 mm
L 150 mm



Art. 1055/4
Ø 12 x 12 mm
H 1000 mm
L 125 mm



MODELLO REGISTRATO
IN UNO DEI PAESI
MARCHI ARTEFERRO

Art. 1699/4
Ø 12 mm
H 1000 mm
L 100 mm



MODELLO REGISTRATO
IN UNO DEI PAESI
MARCHI ARTEFERRO

Art. 1699/5
Ø 12 mm
H 1000 mm
L 75 mm



Art. 1055/3
Ø 12 x 12 mm
H 1000 mm
L 125 mm



Art. 61/1
liscio/plain
Ø 40 x 4 mm
H 900 mm
L 125 mm
Art. 61/2
martellato
hammered
Ø 40 x 4 mm
H 900 mm
L 125 mm



Art. 64/A/1
 Ø 12 x 12 mm
 H 900 mm
 L 250 mm



Art. 64/A/2
 Ø 12 x 12 mm
 H 900 mm
 L 260 mm



Art. 64/A/3
 Ø 12 x 12 mm
 H 900 mm
 L 220 mm



Art. 64/A/4
 Ø 12 x 12 mm
 H 900 mm
 L 220 mm



Art. 64/B/1
 Ø 12 x 12 mm
 H 900 mm
 L 200 mm



Art. 64/B/2
 Ø 12 x 12 mm
 H 900 mm
 L 200 mm

Art. 64/A/5
 Ø 14 x 14 mm
 H 900 mm
 L 250 mm

Art. 64/A/6
 Ø 14 x 14 mm
 H 900 mm
 L 260 mm

Art. 64/A/7
 Ø 14 x 14 mm
 H 900 mm
 L 220 mm

Art. 64/A/8
 Ø 14 x 14 mm
 H 900 mm
 L 220 mm

Art. 64/B/4
 Ø 14 x 14 mm
 H 900 mm
 L 200 mm

Art. 64/B/5
 Ø 14 x 14 mm
 H 900 mm
 L 200 mm



Art. 64/E/1
 Ø 12 x 12 mm
 H 900 mm
 L 137 mm



Art. 64/E/2
 Ø 12 x 12 mm
 H 900 mm
 L 105 mm



Art. 64/E/3
 Ø 12 x 12 mm
 H 900 mm
 L 192 mm



H 900 mm
 L 225 mm
Art. 64/G/1
 Ø 12 x 12 mm

Art. 64/G/2
 Ø 14 x 14 mm



Ø 16 x 12 mm
Art. 66/5
 H 720 mm
 L 180 mm

Art. 66/6
 H 820 mm
 L 180 mm

Art. 66/7
 H 900 mm
 L 180 mm



Ø 16 x 12 mm
Art. 66/8
 H 720 mm
 L 180 mm

Art. 66/9
 H 820 mm
 L 180 mm

Art. 66/10
 H 900 mm
 L 180 mm



Art. 185/7
 Ø 12 x 12 mm
 H 900 mm
 L 220 mm



Ø 16 x 12 mm
Art. 67/1
 H 720 mm
 L 225 mm

Art. 67/2
 H 820 mm
 L 225 mm



Ø 16 x 12 mm
Art. 67/3
 H 720 mm
 L 225 mm

Art. 67/4
 H 820 mm
 L 225 mm



Ø 16 x 12 mm
Art. 67/5
 H 720 mm
 L 205 mm

Art. 67/6
 H 820 mm
 L 225 mm



Ø 16 x 12 mm
Art. 67/7
 H 720 mm
 L 205 mm

Art. 67/8
 H 820 mm
 L 225 mm



Zincato - Galvanized
Art. 185/5
 Ø 12 x 12 mm
 H 900 mm
 L 235 mm



Zincato - Galvanized
Art. 185/8
 Ø 12 x 12 mm
 H 900 mm
 L 250 mm



Art. 52/F/1
 Ø 12 x 12 mm
 H 900 mm
 L 260 mm

Art. 52/F/2
 Ø 14 x 14 mm
 H 900 mm
 L 260 mm

Art. 1753/3
 Ø 12 x 12 mm
 H 1000 mm
 L 260 mm



Art. 52/H/4
 Ø 12 x 12 mm
 H 900 mm
 L 130 mm



Art. 52/H/5
 Ø 12 x 12 mm
 H 900 mm
 L 130 mm



Art. 53/1
 Ø 12 x 12 mm
 H 900 mm
 L 235 mm



Art. 53/2
 Ø 12 x 12 mm
 H 900 mm
 L 230 mm



Art. 64/2
 Ø 8 x 8 mm
 H 850 mm
 L 140 mm



Art. 55/1
 Ø 8 x 8 mm
 H 820 mm
 L 205 mm



Art. 55/5
 Ø 8 x 8 mm
 H 720 mm
 L 220 mm



Art. 55/2
 Ø 8 x 8 mm
 H 900 mm
 L 205 mm



Art. 55/6
 Ø 8 x 8 mm
 H 820 mm
 L 220 mm



Art. 56/1
 Ø 8 x 8 mm
 H 800 mm
 L 140 mm



Art. 56/3
 Ø 8 x 8 mm
 H 800 mm
 L 200 mm



Art. 56/5
 Ø 8 x 8 mm
 H 800 mm
 L 130 mm



Art. 57/1
 Ø 8 x 8 mm
 H 800 mm
 L 200 mm



Art. 57/3
 Ø 8 x 8 mm
 H 800 mm
 L 100 mm



Art. 58/2
 Ø 8 x 8 mm
 H 800 mm
 L 160 mm



H 900 mm
 L 120 mm
Art. 60/3
 Ø 12 x 12 mm

Art. 56/4
 Ø 8 x 8 mm
 H 900 mm
 L 200 mm

Art. 56/6
 Ø 8 x 8 mm
 H 900 mm
 L 130 mm

Art. 57/2
 Ø 8 x 8 mm
 H 900 mm
 L 200 mm

Art. 57/4
 Ø 8 x 8 mm
 H 900 mm
 L 100 mm

Art. 58/3
 Ø 8 x 8 mm
 H 900 mm
 L 160 mm

Art. 60/4
 Ø 14 x 14 mm



900 x 130 mm

Art. 48/5

Φ 12 x 12 mm

Art. 48/10

Φ 14 x 14 mm

Art. 48/15

Φ 16 x 16 mm



Art. 49/1

Φ 12 x 12 mm

H 900 mm

L 250 mm



Art. 49/2

Φ 12 x 12 mm

H 900 mm

L 165 mm



Art. 49/4

Φ 12 x 12 mm

H 900 mm

L 125 mm



52/E/3

Φ 12 x 12 mm

H 900 mm

L 235 mm



Art. 60/1

20 x 4 mm

H 720 mm

L 175 mm

Art. 60/2

20 x 4 mm

H 820 mm

L 175 mm



Art. 50/1

Φ 12 x 12 mm

H 900 mm

L 285 mm



Art. 50/2

Φ 12 x 12 mm

H 900 mm

L 260 mm



Art. 50/3

Φ 12 x 12 mm

H 900 mm

L 165 mm



Art. 50/4

Φ 12 x 12 mm

H 900 mm

L 135 mm



Art. 466/1

Φ 8 x 8 mm

H 900 mm

L 215 mm



Art. 52/B/1

Φ 12 x 12 mm

H 900 mm

L 150 mm



Art. 52/B/2

Φ 12 x 12 mm

H 900 mm

L 310 mm



Art. 52/B/3

Φ 12 x 12 mm

H 900 mm

L 220 mm



Art. 52/E/2

Φ 12 x 12 mm

H 900 mm

L 185 mm



Art. 52/E/4

Φ 12 x 12 mm

H 900 mm

L 230 mm



Art. 465/1

Φ 8 x 8 mm

H 900 mm

L 130 mm



Art. 70/B/1
 Ø 12 x 12 mm
 H 900 mm
 L 196 mm



Art. 70/B/2
 Ø 12 x 12 mm
 H 1200 mm
 L 196 mm



Art. 70/B/4
 Ø 12 x 12 mm
 H 1200 mm
 L 196 mm



Art. 97/1
 Ø 14 x 14 mm
 H 830 mm
 L 130 mm



Art. 97/2
 Ø 14 x 14 mm
 H 830 mm
 L 130 mm



Art. 97/3
 Ø 14 x 14 mm
 H 830 mm
 L 130 mm



Art. 98/B/2
 Ø 14 x 14 mm
 H 900 mm
 L 135 mm

Art. 70/B/3
 Ø 12 x 12 mm
 H 1500 mm
 L 196 mm

Art. 70/B/5
 Ø 12 x 12 mm
 H 1500 mm
 L 196 mm



Art. 98/B/3
 Ø 14 x 14 mm
 H 900 mm
 L 210 mm



Art. 102/4
 Ø 12 x 12 mm
 H 900 mm
 L 110 mm



Art. 102/3
 H 1000 mm



Art. 106/1
 H 1000 mm
 L 150 mm



Art. 107/1
 Ø 12 mm
 H 1000 mm
 L 140 mm



Art. 134/D/7
 Ø 8 x 8 mm
 H 900 mm



Art. 134/F/4
 Ø 10 x 10 mm
 H 900 mm
 L 250 mm



Art. 134/D/8
 Ø 12 x 6 mm
 H 900 mm



Art. 134/E/1
 Ø 12 mm
 H 900 mm
 L 275 mm



Art. 134/E/4
 Ø 15 x 6 mm
 H 900 mm
 L 100 mm



Art. 134/E/5
 Ø 12 x 12 mm
 H 900 mm
 L 160 mm



Art. 134/F/1
 Ø 10 x 10 mm
 H 900 mm
 L 190 mm



Art. 134/F/3
 Ø 10 x 10 mm
 H 900 mm
 L 250 mm



Art. 134/F/5
 Ø 12 x 12 mm
 H 900 mm
 L 250 mm

Art. 134/D/9
 Ø 12 x 12 mm

Art. 134/D/10
 Ø 12 x 12 mm
 H 1200 mm



Art. 134/F/6
 Ø 8 x 8 mm
 H 900 mm
 L 250 mm



Art. 134/F/7
 Ø 8 x 8 mm
 H 900 mm
 L 205 mm



Art. 134/F/8
 Ø 12 x 12 mm
 H 900 mm
 L 235 mm



Art. 134/G/1
 Ø 12 x 12 mm
 H 900 mm
 L 140 mm



Art. 134/G/2
 Ø 12 x 12 mm
 H 900 mm
 L 140 mm



Art. 134/H/1
 Ø 12 x 12 mm
 H 900 mm
 L 155 mm



Art. 134/H/2
 Ø 12 x 12 mm
 H 900 mm
 L 155 mm



Art. 160/E/1
 Fiori in ottone su un lato
Brass flowers on one side
 Ø 12 x 12 mm
 H 900 mm
 L 215 mm



Art. 163/1
 Ø 12 x 12 mm
 H 1050 mm
 L 205 mm



Art. 163/3
 □ 16 x 4 mm
 H 1050 mm
 L 205 mm



Art. 466/2
 Ø 8 x 8 mm
 H 900 mm
 L 130 mm



Art. 467/1
 Ø 8 x 8 mm
 H 900 mm
 L 130 mm



Art. 468/1
 Ø 8 x 8 mm
 H 900 mm
 L 130 mm



Art. 468/2
 Ø 8 x 8 mm
 H 900 mm
 L 180 mm



Art. 160/E/5
 Fiori in ottone su un lato
Brass flowers on one side
 Ø 14 x 14 mm
 H 900 mm
 L 215 mm



Art. 468/3
 Ø 8 x 8 mm
 H 900 mm
 L 160 mm



Art. 468/4
 Ø 8 x 8 mm
 H 900 mm
 L 145 mm



Art. 469/1
 Ø 8 x 8 mm
 H 900 mm
 L 145 mm



Art. 470/1
 Ø 14 x 14 mm
 H 900 mm
 L 250 mm



Art. 472/2
 Ø 12 x 12 mm
 H 900 mm
 L 200 mm



Art. 472/3
 Ø 12 x 12 mm
 H 900 mm
 L 320 mm



Art. 486/1
 □ 16 x 8 mm
 H 900 mm
 L 140 mm



ARTEFERRO



Art. 538/1
 Φ 8 x 8 mm
 H 900 mm
 L 170 mm



Art. 538/2
 Φ 8 x 8 mm
 H 900 mm
 L 215 mm



Art. 539/1
 Φ 12 x 12 mm
 H 900 mm
 L 190 mm



Art. 539/2
 Φ 12 x 12 mm
 H 900 mm
 L 190 mm



Art. 1678/2
 \square 14 x 8 mm
 H 1000 mm
 L 205 mm



Art. 570/1
 Φ 12 x 12 mm
 H 900 mm
 L 140 mm



Art. 570/3
 Φ 12 x 12 mm
 H 900 mm
 L 100 mm



Art. 570/2
 Φ 14 x 14 mm
 H 900 mm
 L 140 mm

Art. 570/4
 Φ 14 x 14 mm
 H 900 mm
 L 100 mm



Art. 1688/4
 Φ 12 mm
 H 1000 mm
 L 200 mm



Art. 1688/3
 Φ 12 mm
 H 1000 mm
 L 200 mm



Art. 1688/2
 Φ 12 mm
 H 1000 mm
 L 200 mm



Art. 1688/1
 Φ 12 mm
 H 1000 mm
 L 200 mm



Art. 1695/1
 Φ 12 mm
 H 1000 mm
 L 200 mm



Art. 1695/2
 Φ 12 mm
 H 1000 mm
 L 200 mm



Art. 1695/3
 Φ 12 mm
 H 1000 mm
 L 200 mm



Art. 1695/4
 Φ 12 mm
 H 1000 mm
 L 200 mm



Art. 1695/5
 Φ 12 mm
 H 1000 mm
 L 200 mm



Art. 1695/6
 Φ 12 mm
 H 1000 mm
 L 200 mm



Art. 1695/11
 Φ 12 mm
 H 1000 mm
 L 200 mm



Art. 1695/12
 Φ 12 mm
 H 1000 mm
 L 200 mm



Art. 1695/7
 Φ 12 mm
 H 1000 mm
 L 200 mm



Art. 1695/8
 Φ 12 mm
 H 1000 mm
 L 200 mm



Art. 1695/9
 Φ 12 mm
 H 1000 mm
 L 200 mm



Art. 1695/10
 Φ 12 mm
 H 1000 mm
 L 200 mm



Art. 1054/1
 Ø 12 mm
 H 1000 mm
 L 180 mm



Art. 1054/2
 Ø 12 mm
 H 1000 mm
 L 350 mm



Art. 1054/3
 Ø 12 mm
 H 1000 mm
 L 180 mm



Art. 1054/4
 Ø 12 mm
 H 1000 mm
 L 110 mm



Art. 1054/5
 Ø 12 mm
 H 1000 mm
 L 210 mm



Art. 1054/6
 Ø 12 mm
 H 1000 mm
 L 110 mm



Art. 1055/1
 Ø 12 x 12 mm
 H 1000 mm
 L 115 mm



Art. 1055/2
 Ø 12 x 12 mm
 H 1000 mm
 L 115 mm



Art. 1055/5
 Ø 12 x 12 mm
 H 1000 mm
 L 115 mm



Art. 1055/6
 Ø 12 x 12 mm
 H 1000 mm
 L 115 mm



Art. 1056/1
 Ø 12 x 12 mm
 H 1000 mm
 L 125 mm



Art. 1056/2
 Ø 12 x 12 mm
 H 1000 mm
 L 125 mm



Art. 1056/3
 Ø 12 x 12 mm
 H 1000 mm
 L 125 mm



Art. 1056/4
 Ø 12 x 12 mm
 H 1000 mm
 L 125 mm



Art. 1058/1
 Ø 12 x 12 mm
 H 1000 mm
 L 155 mm



Art. 1058/2
 Ø 12 x 12 mm
 H 1000 mm
 L 155 mm



Art. 1066/3
 Ø 12 mm
 H 1000 mm
 L 180 mm



Art. 1066/4
 Ø 12 mm
 H 1000 mm
 L 180 mm



Art. 1066/5
 Ø 12 mm
 H 1000 mm
 L 180 mm



Art. 584/A/4
 Ø 12 x 12 mm
 H 900 mm
 L 155 mm



Art. 584/A/5
 Ø 12 x 12 mm
 H 900 mm
 L 155 mm



Art. 584/A/6
 Ø 12 x 12 mm
 H 900 mm
 L 230 mm

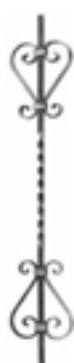

Art. 584/B/1
 Ø 12 x 12 mm
 H 900 mm
 L 165 mm



Art. 584/B/2
 Ø 12 x 12 mm
 H 900 mm
 L 165 mm



Art. 584/B/4
 Ø 12 x 12 mm
 H 900 mm
 L 200 mm



Art. 584/B/3
 Ø 12 x 12 mm
 H 900 mm
 L 165 mm



Art. 584/B/5
 Ø 12 x 12 mm
 H 900 mm
 L 140 mm



Art. 584/B/6
 Ø 12 x 12 mm
 H 900 mm
 L 130 mm

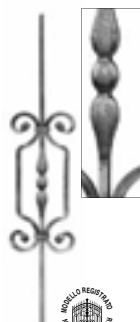

Art. 586/1
 Ø 12 x 12 mm
 H 900 mm
 L 195 mm

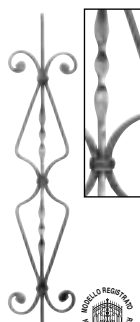

Art. 586/2
 Ø 8 x 8 mm
 H 900 mm
 L 190 mm

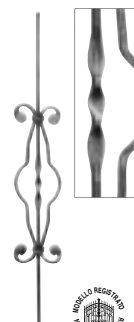

Art. 586/3
 Ø 8 x 8 mm
 H 900 mm
 L 130 mm



Art. 1753/6
 Ø 12 x 12 mm
 H 1000 mm
 L 260 mm

FREGI IN GHISA - CAST IRON ORNAMENTS



Art. 754/1
 H 900 mm
 L 190 mm



Art. 754/2
 H 1000 mm
 L 165 mm



Art. 754/3
 H 1000 mm
 L 105 mm

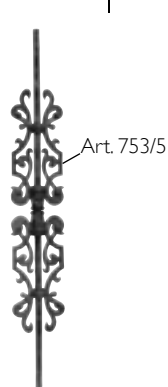

Art. 755/1
 Ø 10 mm
 H 900 mm
 L 130 mm



Art. 1051/1
 Ø 12 x 12 mm
 185 x 1000 mm

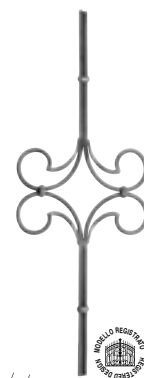

Art. 1053/1
 Ø 24 x 12 mm
 H 1000 mm
 L 360 mm



Art. 1071/1
 Ø 12 mm
 H 920 mm
 L 250 mm



Art. 1071/2
 Ø 12 mm
 H 1000 mm
 L 235 mm



Art. 1071/3
 Ø 12 mm
 H 1000 mm
 L 110 mm



Art. 1071/4
 Ø 12 mm
 H 1000 mm
 L 210 mm



Art. 1071/5
 Ø 12 mm
 H 1000 mm
 L 110 mm



Art. 1073/3
 Ø 10 mm
 H 1000 mm
 L 160 mm

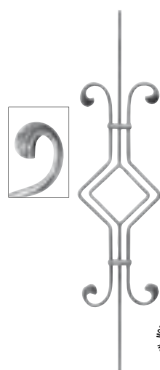

Art. 1074/1
 Ø 10 mm
 H 1000 mm
 L 205 mm

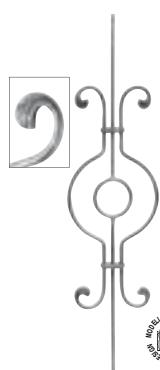

Art. 1074/2
 Ø 10 mm
 H 1000 mm
 L 230 mm



Art. 1075/1
 Ø 10 mm
 H 1000 mm
 L 245 mm

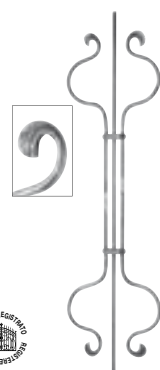

Art. 1075/2
 Ø 10 mm
 H 1000 mm
 L 245 mm

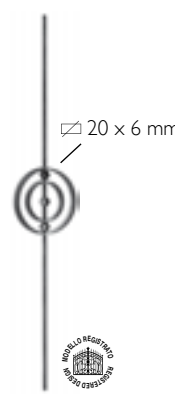

Art. 1082/1
 Ø 10 mm
 H 1000 mm
 L 160 mm



Art. 1082/2
 Ø 10 mm
 H 1000 mm
 L 160 mm

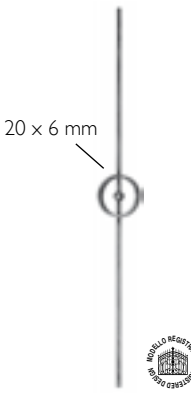

Art. 1082/3
 Ø 10 mm
 H 1000 mm
 L 100 mm

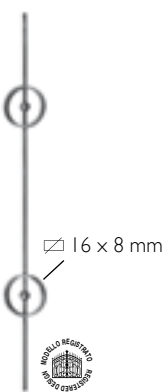

Art. 1082/4
 Ø 10 mm
 H 1000 mm
 L 100 mm



Art. 1084/1
 Ø 12 x 12 mm
 H 1000 mm
 L 175 mm



Art. 1084/2
 Ø 12 x 12 mm
 H 1000 mm
 L 175 mm



Art. 1084/3
 Ø 12 x 12 mm
 H 1000 mm
 L 100 mm



Art. 1084/4
 Ø 12 x 12 mm
 H 1000 mm
 L 100 mm



Art. 1089/1
 Ø 12 x 12 mm
 H 1000 mm
 L 100 mm



Art. 1089/2
 Ø 12 x 12 mm
 H 1000 mm
 L 100 mm



Art. 1089/3
Φ 12 x 12 mm
H 1000 mm
L 100 mm



Art. 1089/4
Φ 12 x 12 mm
H 1000 mm
L 165 mm



Art. 1122/2
Φ 12 x 12 mm
H 1000 mm
L 140 mm



Art. 1122/1
Φ 12 x 12 mm
H 1000 mm
L 140 mm



Art. 1122/3
Φ 12 x 12 mm
H 1000 mm
L 180 mm



Art. 1122/4
Φ 12 x 12 mm
H 1000 mm
L 140 mm



Art. 1122/5
Φ 12 x 12 mm
H 1000 mm
L 140 mm



Art. 1124/1
Φ 12 x 12 mm
H 1000 mm
L 225 mm



Art. 1124/2
Φ 12 x 12 mm
H 1000 mm
L 240 mm



Art. 1124/3
Φ 12 x 12 mm
H 1000 mm
L 220 mm



Art. 1124/4
∅ 30 x 8 mm
H 1000 mm
L 130 mm



Art. 1125/1
Φ 10 x 10 mm
H 1000 mm
L 275 mm



Art. 1125/2
Φ 10 x 10 mm
H 1000 mm
L 175 mm



Art. 1126/1
Φ 14 x 14 mm
H 1000 mm
L 230 mm



Art. 1126/2
Φ 14 x 14 mm
H 1000 mm
L 220 mm

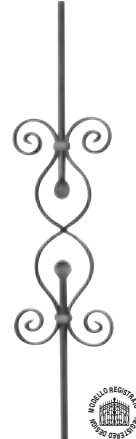

Art. 1127/3
Φ 12 x 12 mm
H 1000 mm
L 205 mm



Art. 1127/4
Φ 12 x 12 mm
H 1000 mm
L 165 mm



Art. 1127/5
Φ 12 x 12 mm
H 1000 mm
L 165 mm



Art. 1128/1
Φ 12 x 12 mm
H 1000 mm
L 170 mm



Art. 1128/2
 Ø 12 x 12 mm
 H 1000 mm
 L 195 mm



Art. 1128/3
 Ø 12 x 12 mm
 H 1000 mm
 L 120 mm



Art. 1128/4
 Ø 12 x 12 mm
 H 1000 mm
 L 105 mm



Art. 1128/5
 Ø 12 x 12 mm
 H 1000 mm
 L 125 mm

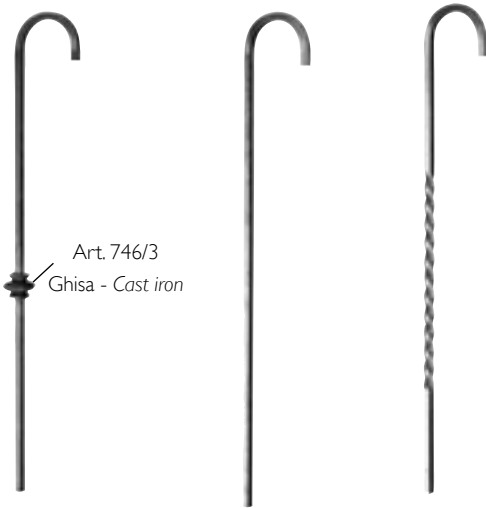

Art. 746/3
 Ghisa - Cast iron

Art. 1131/1
 Ø 14 x 14 mm
 H 1000 mm
 L 130 mm



Art. 1131/2
 Ø 14 x 14 mm
 H 1000 mm
 L 130 mm



Art. 1131/3
 Ø 14 x 14 mm
 H 1000 mm
 L 130 mm



Art. 1699/8
 Ø 12 mm
 H 1000 mm
 L 160 mm



Art. 1699/9
 Ø 12 mm
 H 1000 mm
 L 130 mm



Art. 116/A/4

Art. 1678/3
 14 x 8 mm
 H 1000 mm
 L 260 mm



Art. 1678/4
 14 x 8 mm
 H 1000 mm
 L 260 mm



ARTEFERRO



Art. 1160/6
 Ø 12 x 12 mm
 H 1200 mm
 L 190 mm



Art. 1141/1
 Ø 12 x 12 mm
 H 1000 mm
 L 195 mm

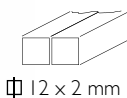

Ø 12 x 2 mm



Art. 1141/2
 Ø 12 x 12 mm
 H 1000 mm
 L 195 mm

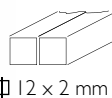

Ø 12 x 2 mm



Art. 1325/1
 Ø 12 x 12 mm
 H 1000 mm
 L 130 mm



Art. 1325/2
 Ø 12 x 12 mm
 H 1000 mm
 L 130 mm

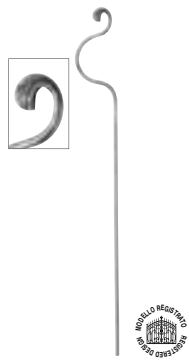

Art. 1303/1
Ø 10 mm
H 830 mm
L 105 mm



Art. 1303/2
Ø 10 mm
H 830 mm
L 105 mm

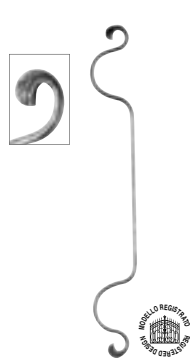

Art. 1303/3
Ø 10 mm
H 800 mm
L 105 mm

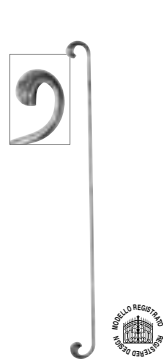

Art. 1303/4
Ø 10 mm
H 780 mm
L 65 mm



Art. 1303/5
Ø 10 mm
H 565 mm
L 90 mm



Art. 1303/6
Ø 10 mm
H 550 mm
L 105 mm



Art. 589/6
Ø 20 x 8 mm
H 900 mm



Art. 201/3
Ø 12 x 12 mm
H 1100 mm



Art. 201/1
Ø 12 x 12 mm
H 1500 mm



Art. 201/2
Ø 12 x 12 mm
H 1700 mm



Art. 141/1
Ø 20 x 4 mm
H 800 mm

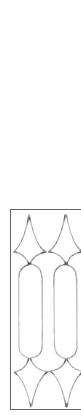

Art. 141/3
Ø 20 x 4 mm
H 800 mm

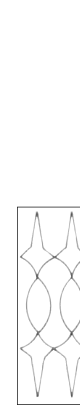

Art. 141/4
Ø 20 x 4 mm
H 800 mm

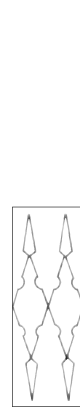

Art. 141/5
Ø 20 x 4 mm
H 800 mm

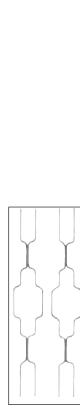

Art. 142/2
Ø 20 x 4 mm
H 800 mm

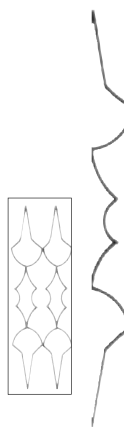

Art. 142/3
Ø 20 x 4 mm
H 800 mm

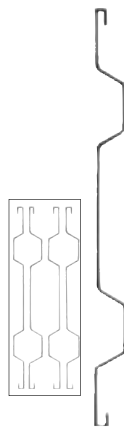

Art. 142/6
Ø 20 x 4 mm
H 800 mm

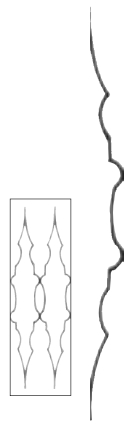

Art. 142/7
Ø 20 x 4 mm
H 800 mm

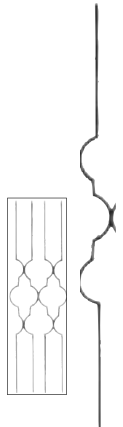

Art. 142/8
Ø 20 x 4 mm
H 800 mm

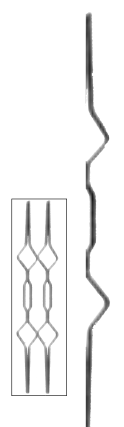

Art. 142/5
Ø 20 x 4 mm
H 800 mm

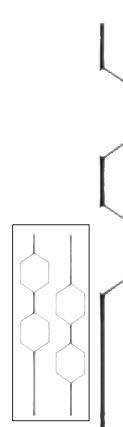

Art. 141/2
Ø 20 x 4 mm
H 800 mm

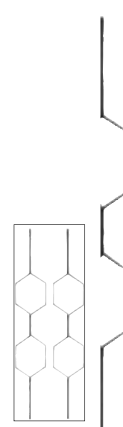

Art. 141/6
Ø 20 x 4 mm
H 800 mm

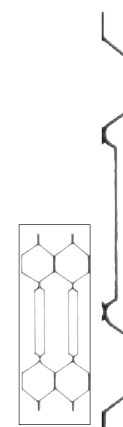

Art. 142/1
Ø 20 x 4 mm
H 800 mm

**Paletti in ferro con
Borchie in Ottone**

*Iron pickets with
Brass bushes*



	H 820 mm	H 900 mm	H 820 mm	H 900 mm	H 820 mm	H 900 mm	H 820 mm	H 900 mm
	Cod.art. Art.no.	Cod.art. Art.no.	Cod.art. Art.no.	Cod.art. Art.no.	Cod.art. Art.no.	Cod.art. Art.no.	Cod.art. Art.no.	Cod.art. Art.no.
Ø 10 mm	160/1	160/6	160/11	160/16	160/21	160/26	160/31	160/36
Ø 12 mm	160/2	160/7	160/12	160/17	160/22	160/27	160/32	160/37
Ø 14 mm	160/3	160/8	160/13	160/18	160/23	160/28	160/33	160/38
Ø 16 mm	160/4	160/9	160/14	160/19	160/24	160/29	160/34	160/39
Ø 18 mm	160/5	160/10	160/15	160/20	160/25	160/30	160/35	160/40

Sez. Ø 10 mm - Ø 14 mm - Ø 16 mm - Ø 18 mm : *Quantità minima 200 pezzi / Minimum quantity 200 pieces*
 Qualsiasi altezza su richiesta - *Alternative heights upon request*



Art. 581/1
 Ø 12 x 12 mm
 H 900 mm
 L 265 mm



Art. 581/2
 Ø 12 x 12 mm
 H 900 mm
 L 265 mm



Art. 581/3
 Ø 12 x 12 mm
 H 900 mm
 L 265 mm



Art. 581/4
 Ø 12 x 12 mm
 H 900 mm
 L 265 mm



Art. 581/5
 Ø 12 x 12 mm
 H 900 mm
 L 265 mm



Art. 581/6
 Ø 12 x 12 mm
 H 900 mm
 L 265 mm



Art. 581/7
 Ø 12 x 12 mm
 H 900 mm
 L 265 mm



Art. 581/8
 Ø 12 x 12 mm
 H 900 mm
 L 265 mm



Art. 581/9
 Ø 12 x 12 mm
 H 900 mm
 L 265 mm



Art. 581/10
 Ø 12 x 12 mm
 H 900 mm
 L 265 mm



Art. 581/11
 Ø 12 x 12 mm
 H 900 mm
 L 265 mm



Art. 581/12
 Ø 12 x 12 mm
 H 900 mm
 L 265 mm



Art. 584/3
 Ø 12 x 12 mm
 H 900 mm
 L 265 mm



Art. 584/A/3
 Ø 12 x 12 mm
 H 900 mm
 L 180 mm



PALETTI VERNICIATI - POWDER COATED PICKETS COMPENDIUM 2011

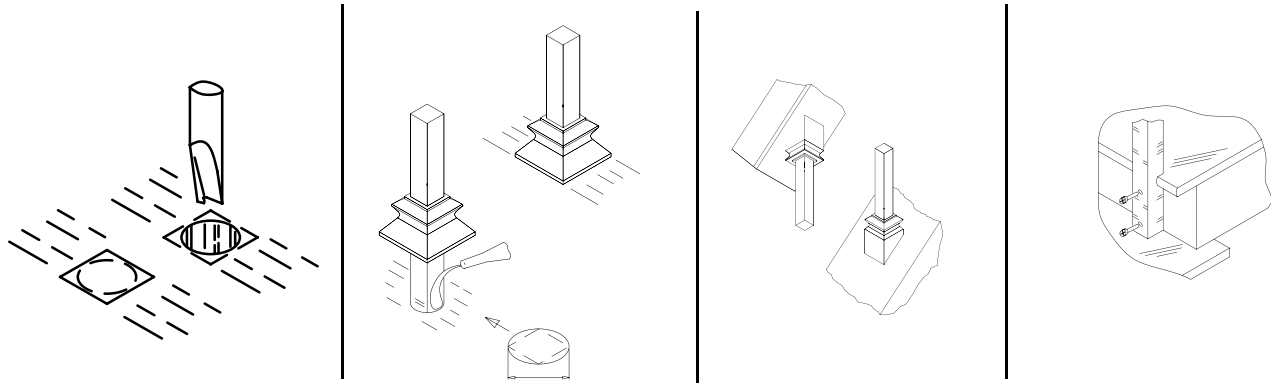

PALETTI CON FINALE ARROTONDATO AD UNA ESTREMITA'

PALETTO 12 x 12 MM - ESTREMITÀ TORNITA Ø 12 MM

PALETTO 14 x 14 MM - ESTREMITÀ TORNITA Ø 14 MM

ROUNDED END ON ONE SIDE PICKETS

PICKET SQ. 12 x 12 MM - ROUNDED END Ø 12 MM

PICKET SQ. 14 x 14 MM - ROUNDED END Ø 14 MM

COLORI DISPONIBILI:

AVAILABLE COLORS:

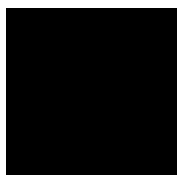

CB
Nero Classico
Classic Black

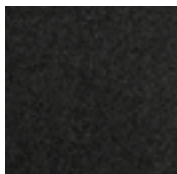

WIB
Nero Forgia
Wrought Iron Black

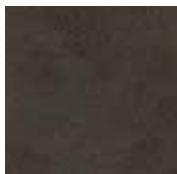

MB
Bronzo
Midnight Bronze



OWC
Rame
Old World Copper



DC
Champagne
Dark Champagne



SG
Grigio
Shadow Grey



WN
Grigio Nichel
Warm Nickel

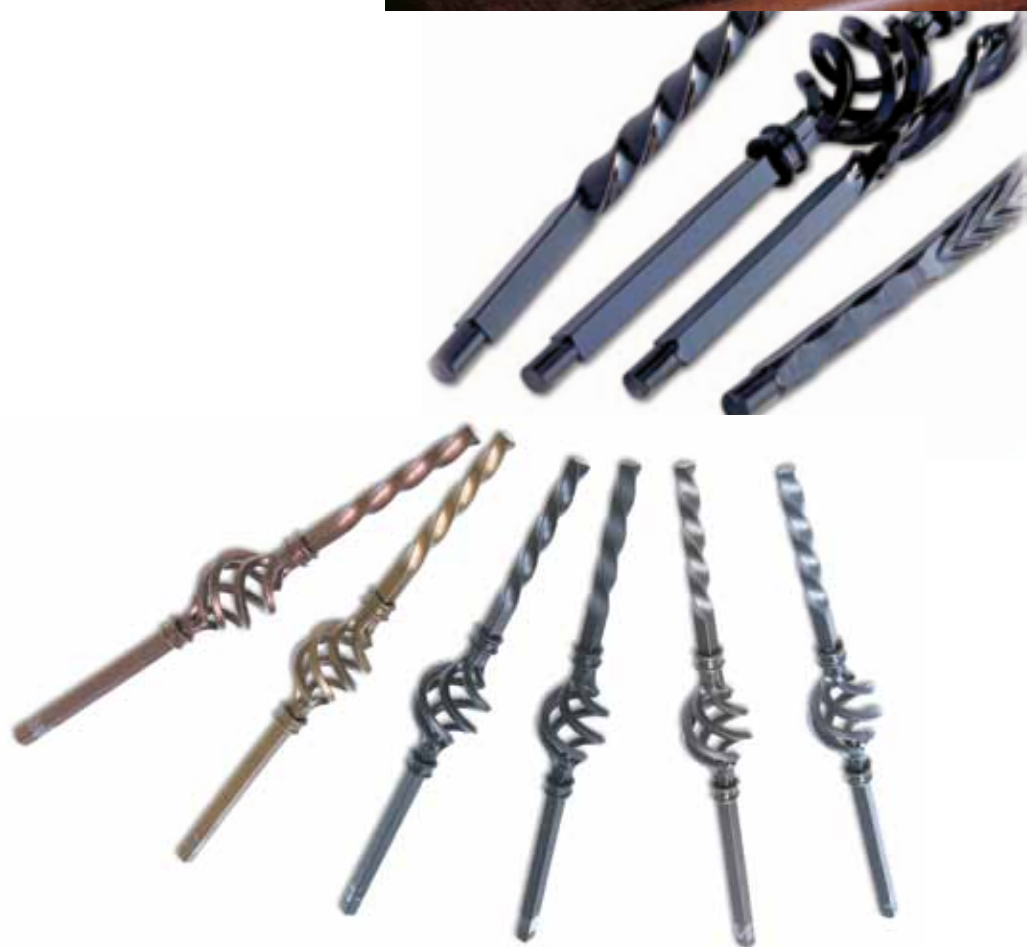

TUTTI I PALETTI CON FINALE ARROTONDATO AD UNA ESTREMITA' SONO DISPONIBILI ANCHE GREZZI

ALL ROUNDED END ON ONE SIDE PICKETS ARE AVAILABLES ALSO UNPAINTED



Art. PC4/1
 12 x 12 mm
 H 1120 mm

Art. PC4/2
 14 x 14 mm
 H 1120 mm

Art. PC4/3
 16 x 16 mm
 H 1120 mm



Art. PC4/4
 12 x 12 mm
 H 1120 mm

Art. PC4/5
 14 x 14 mm
 H 1120 mm

Art. PC4/6
 16 x 16 mm
 H 1120 mm



Art. PC6/1
 12 x 12 mm
 H 1120 mm

Art. PC6/2
 14 x 14 mm
 H 1120 mm

Art. PC6/3
 16 x 16 mm
 H 1120 mm



Art. PC6/4
 12 x 12 mm
 H 1120 mm

Art. PC6/5
 14 x 14 mm
 H 1120 mm

Art. PC6/6
 16 x 16 mm
 H 1120 mm



Art. PC12/1
 14 x 14 mm
 H 1120 mm

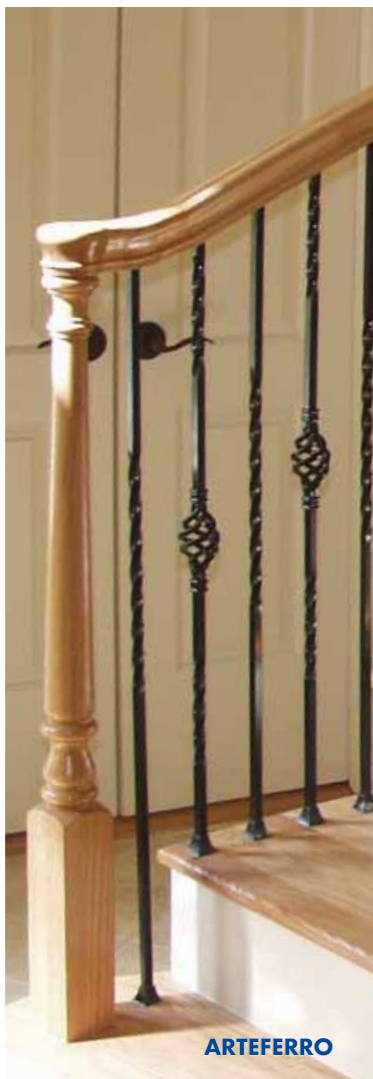

ARTEFERRO



Art. PC8/1
 12 x 12 mm
 H 1120 mm

Art. PC8/2
 14 x 14 mm
 H 1120 mm

Art. PC8/3
 16 x 16 mm
 H 1120 mm



Art. PC8/4
 12 x 12 mm
 H 1120 mm

Art. PC8/5
 14 x 14 mm
 H 1120 mm

Art. PC8/6
 16 x 16 mm
 H 1120 mm



Art. PC10/1
 14 x 14 mm
 H 1120 mm

Art. PC10/2
 16 x 16 mm
 H 1120 mm



Art. PC10/3
 14 x 14 mm
 H 1120 mm

Art. PC10/4
 16 x 16 mm
 H 1120 mm

PALETTI VERNICIATI - POWDER COATED PICKETS

PALETTI FORGIATI - FORGED PICKETS



Art. PC18/1
Φ 14 x 14 mm
H 1120 mm



Art. PC18/2
Φ 14 x 14 mm
H 1120 mm



Art. PC18/3
Φ 14 x 14 mm
H 1120 mm



Art. PC19/1
Φ 14 x 14 mm
H 1120 mm



Art. PC19/2
Φ 14 x 14 mm
H 1120 mm

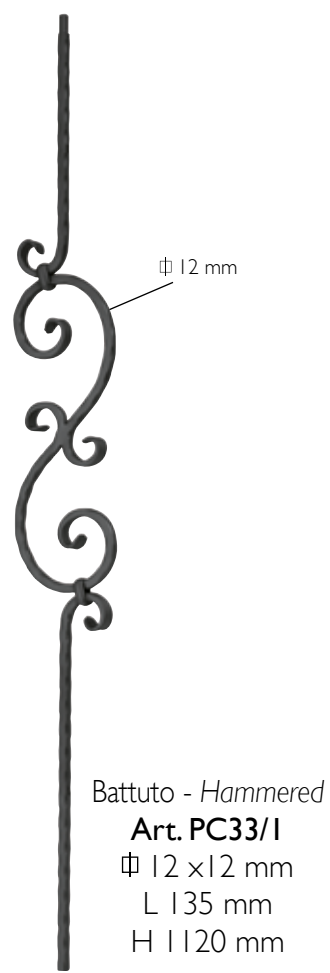
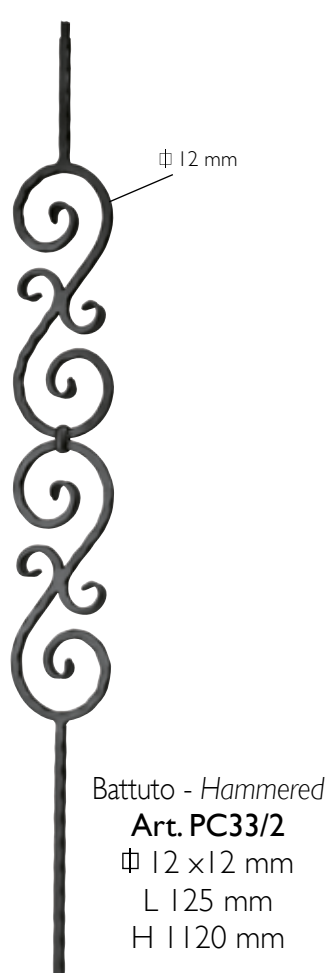
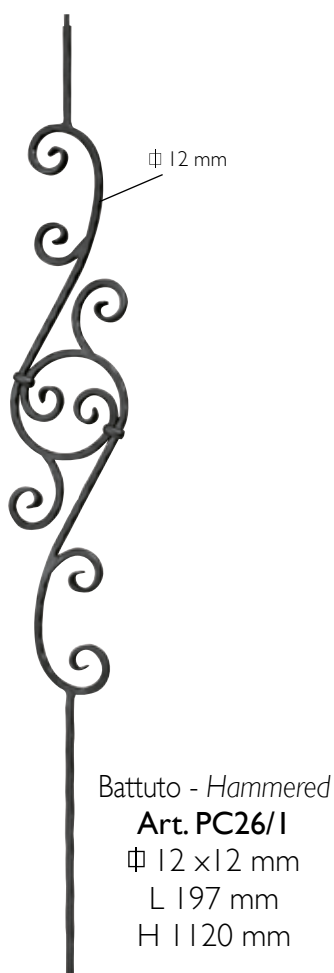
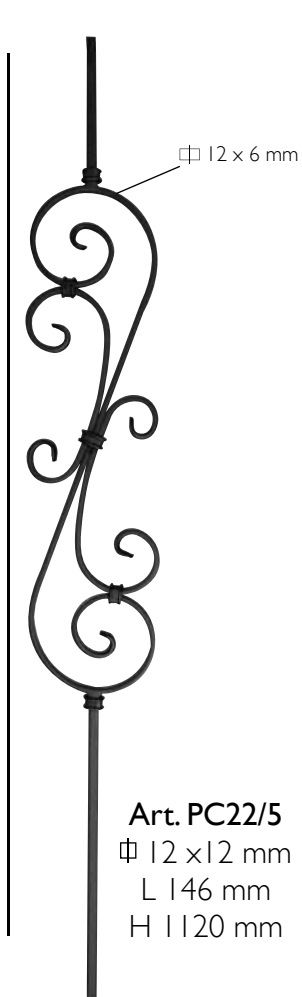

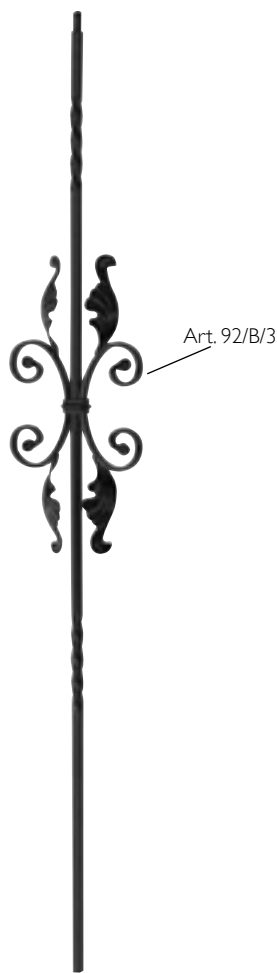

Art. 92/B/3

Art. PC24/1
 Ø 12 x 12 mm
 L 168 mm
 H 1120 mm

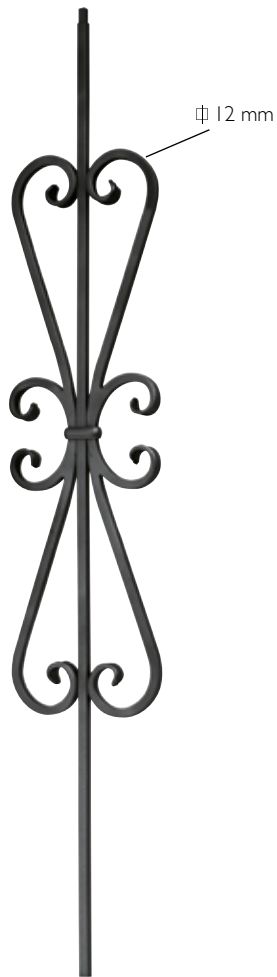

Ø 12 mm

Art. PC28/1
 Ø 12 x 12 mm
 L 185 mm
 H 1120 mm



Ø 14 x 6 mm

Art. PC30/1
 Ø 14 x 14 mm
 L 178 mm
 H 1120 mm

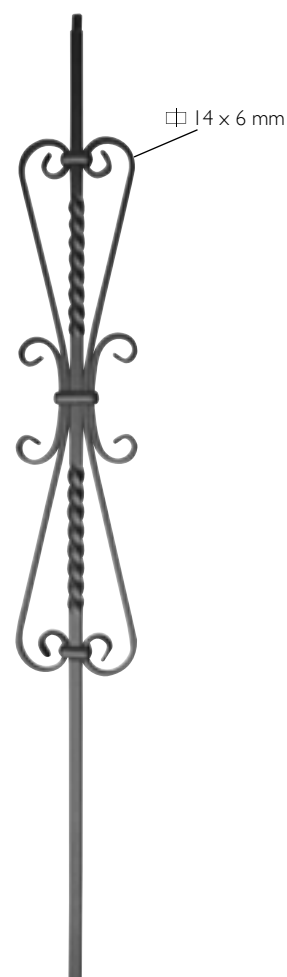

Ø 14 x 6 mm

Art. PC30/2
 Ø 14 x 14 mm
 L 133 mm
 H 1120 mm

PALETTI VERNICIATI - POWDER COATED PICKETS



Liscio - Plain
Art. PC28/2
 Ø 12 mm
 H 1120 mm
 Liscio - Plain
Art. PC28/3
 Ø 14 mm
 H 1120 mm
 Liscio - Plain
Art. PC28/4
 Ø 16 mm
 H 1120 mm



Liscio - Plain
Art. PC28/5
 Ø 12 x 12 mm
 H 1120 mm
 Liscio - Plain
Art. PC28/6
 Ø 14 x 14 mm
 H 1120 mm
 Liscio - Plain
Art. PC28/7
 Ø 16 x 16 mm
 H 1120 mm



ARTEFERRO



Art. PC34/4
 Ø 12 x 12 mm
 L 127 mm
 H 1120 mm



Art. PC34/1
 Ø 12 x 12 mm
 L 127 mm
 H 1120 mm



Art. PC34/2
 Ø 12 x 12 mm
 H 1120 mm



Art. PC34/3
 Ø 12 x 12 mm
 H 1120 mm



Art. 128/2

Art. PC16/1
 Ø 14 x 14 mm
 H 1120 mm



Art. PC16/2
 Ø 14 x 14 mm
 H 1120 mm

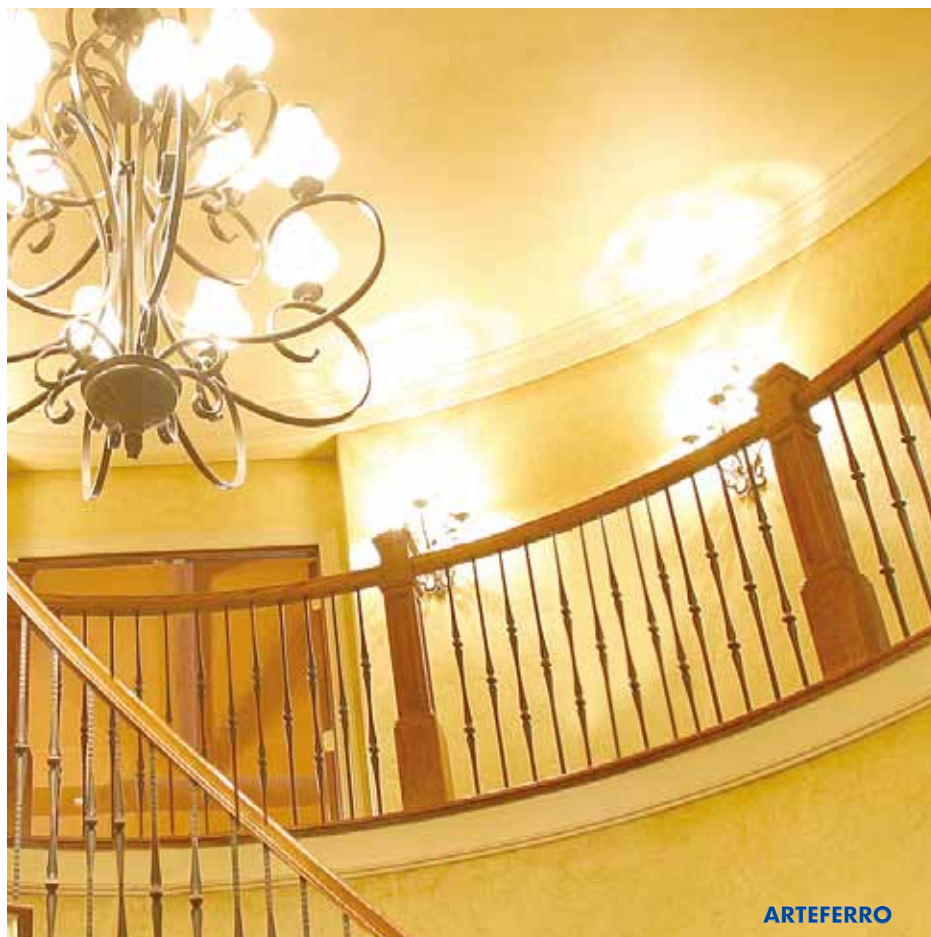

Art. 746/1

Art. PC49/2
 Ø 12 x 12 mm
 H 1120 mm



Art. PC49/1
 Ø 12 x 12 mm
 H 1120 mm

PALETTI VERNICIATI - POWDER COATED PICKETS

ARTEFERRO

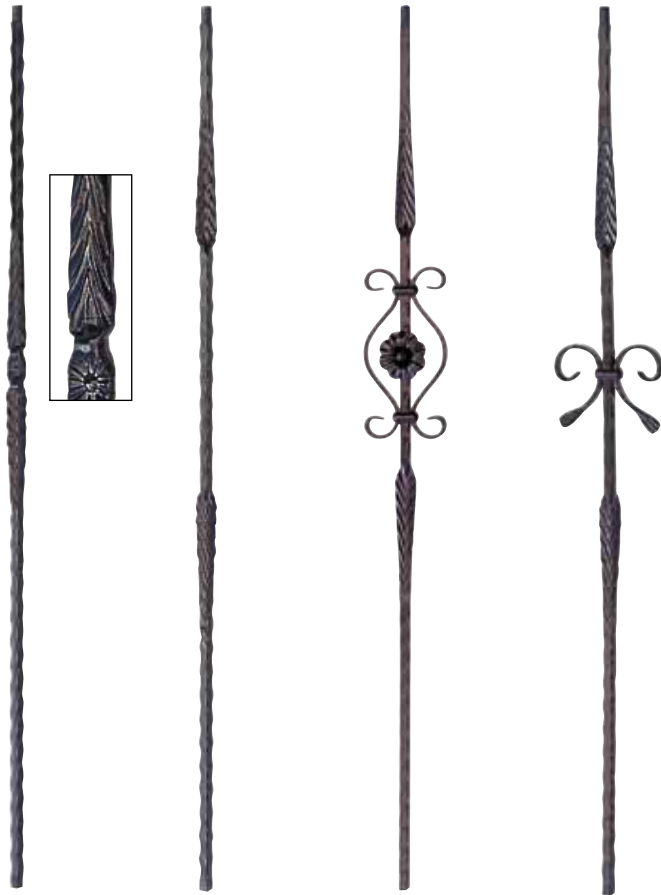

Art. PC38/1 Art. PC38/2 Art. PC40/1 Art. PC38/3
 Ø 14 x 14 mm Ø 14 x 14 mm Ø 14 x 14 mm Ø 14 x 14 mm
 H 1120 mm H 1120 mm H 1120 mm H 1120 mm



Art. PC42/2 Art. PC42/1 Art. PC44/1 Art. PC44/2
 Ø 14 mm Ø 14 mm Ø 14 mm Ø 14 mm
 H 1120 mm H 1120 mm H 1120 mm H 1120 mm
 L 174 mm



ARTEFERRO



ARTEFERRO



Art. PC47/1
 Ø 12 x 12 mm
 L 100 mm
 H 1120 mm



Art. PC48/1
 Ø 12 x 12 mm
 L 70 mm
 H 1120 mm



Art. PC45/2
 Ø 14 x 14 mm
 L 120 mm
 H 1120 mm



Art. PC45/1
 Ø 14 x 14 mm
 L 120 mm
 H 1120 mm



Art. PC52/2
 Ø 16 x 16 mm
 L 90 mm
 H 1120 mm



Art. PC52/1
 Ø 16 x 16 mm
 L 90 mm
 H 1120 mm



Art. PC46/1
 Ø 14 x 14 mm
 H 1120 mm



Art. PC50/1
 Ø 12 x 12 mm
 L 120 mm
 H 1120 mm

PALETTI VERNICIATI - POWDER COATED PICKETS

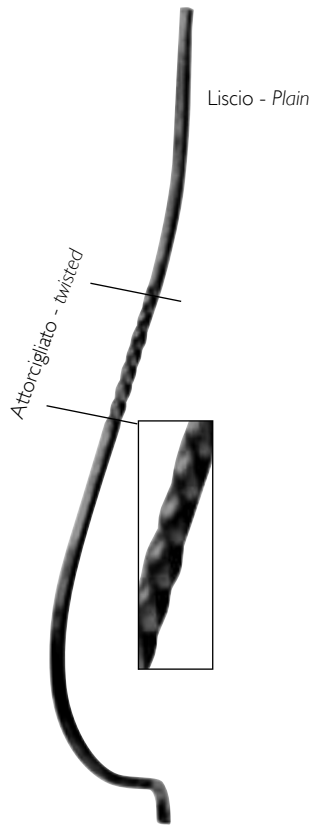

Art. PC54/1
 Ø 14 x 14 mm
 H 1120 mm



Art. PC55/1
 Ø 14 x 14 mm
 H 1120 mm



Art. PC55/2
 Ø 14 x 14 mm
 H 1120 mm



Art. PC55/3
 Ø 14 x 14 mm
 H 1120 mm



ARTEFERRO



Battuto - *Hammered*
Art. PC56/1
 30 x 30 mm
 H 1220 mm



Battuto - *Hammered*
Art. PC56/2
 Ø 30 mm
 H 1220 mm



Forgiato - *Forged*
Art. PC56/3
 Ø 25 mm
 H 1220 mm



Art. PC57/1
 30 x 30 mm
 H 1220 mm



Forgiato - *Forged*
Art. PC57/2
 Ø 30 mm
 H 1220 mm



Art. PC58/3
 30 x 30 mm
 H 1220 mm

CAPOSALDI - NEWEL POSTS



ARTEFERRO



Art. PC58/2
 30 x 30 mm
 H 1220 mm



Art. PC58/1
 30 x 30 mm
 H 1220 mm

PALETTI VERNICIATI - POWDER COATED PICKETS

Zoccoletti/Piastrine verniciate
Painted Shoes/Plates



Art. PC60/3
40 x 28 mm
foro/hole

∅ 13 x 13 mm

Art. PC60/4

40 x 28 mm

foro/hole

∅ 15 x 15 mm

Art. PC60/16

39 x 29 mm

foro/hole

∅ 17 x 17 mm

Art. PC60/2

70 x 45 mm

foro/hole

∅ 27 x 27 mm

Art. PC60/5

70 x 45 mm

foro/hole

∅ 32 x 32 mm



Art. PC60/8

60 x 60 mm

foro/hole ∅ 31 x 31 mm



Art. PC60/7

55 x 55 mm

H 12 mm

foro/hole ∅ 16 x 16 mm



Art. PC60/10

80 x 80 mm

spess./ thick. 8 mm

foro/hole ∅ 15 x 15 mm



Art. PC60/1

30 x 50 mm

foro/hole

13 x 13 mm

Art. PC60/6

30 x 50 mm

foro/hole

15 x 15 mm

Art. PC60/17

32 x 32 mm

foro/hole

17 x 17 mm



Art. PC60/9

H 40 mm

∅ 39 mm

foro/hole ∅ 14 mm



ARTEFERRO

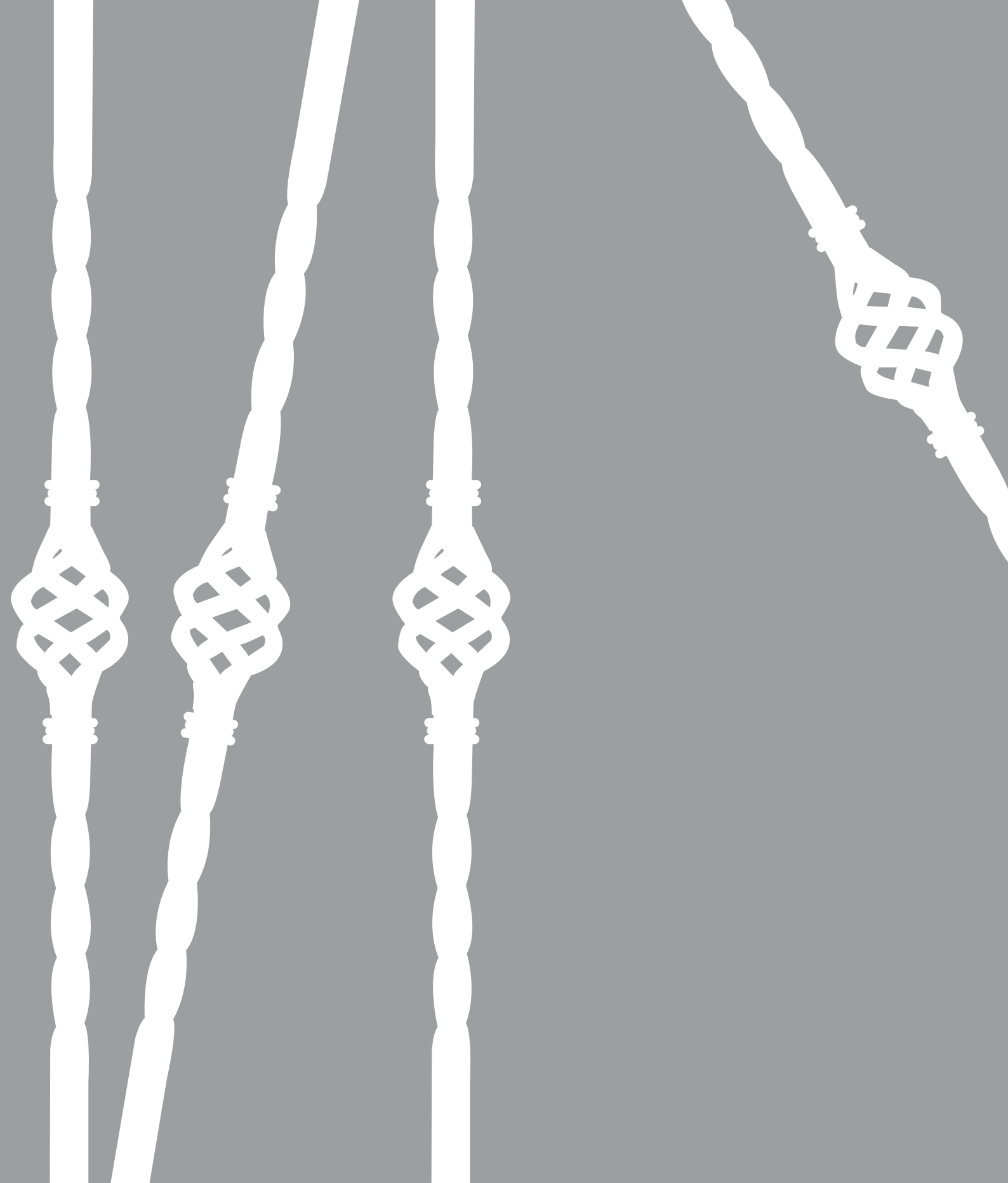

CAPOSALDI - NEWEL POSTS

COMPENDIUM 2011



Art. 112/7
 Ø 25 x 25 mm
 H 1200 mm

Art. 112/8
 Ø 30 x 30 mm
 H 1200 mm

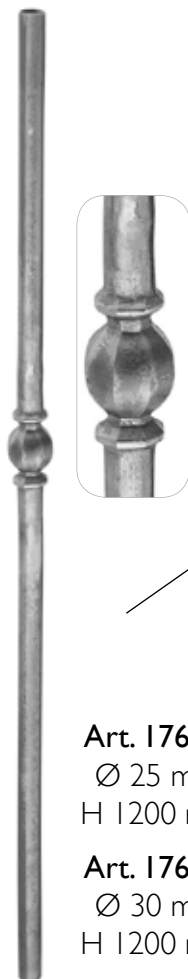

Paletto
 liscio
 con borchia
 fucinata

Plain
 picket with
 hammered
 bush

Art. 1769/5
 Ø 25 mm
 H 1200 mm

Art. 1769/6
 Ø 30 mm
 H 1200 mm

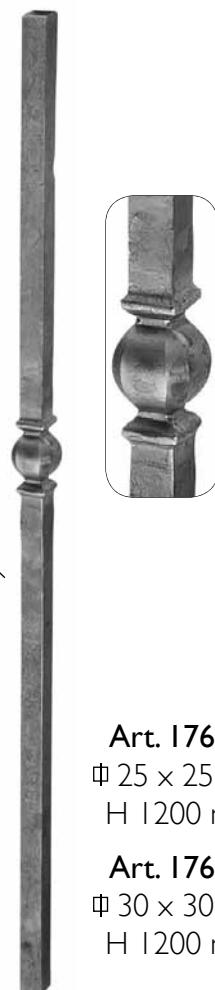

Art. 1769/7
 Ø 25 x 25 mm
 H 1200 mm

Art. 1769/8
 Ø 30 x 30 mm
 H 1200 mm



Art. 666/4



Art. 800/2
 Ø 30 x 30 mm
 H 1200 mm

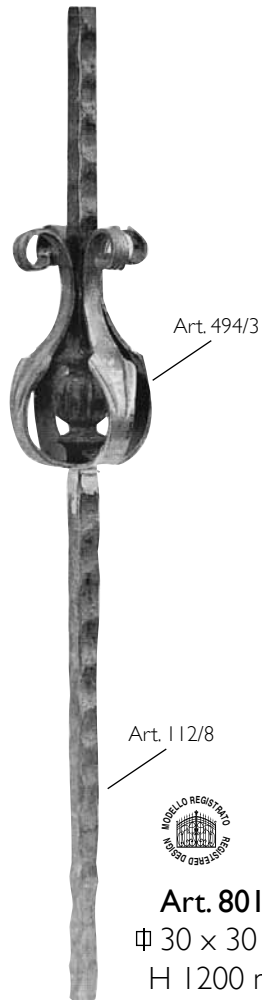

Art. 494/3



Art. 112/8

Art. 801/6
 Ø 30 x 30 mm
 H 1200 mm



ARTEFERRO

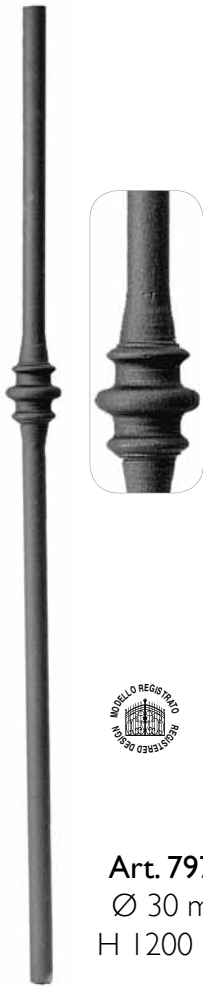

Art. 797/4
 Ø 30 mm
 H 1200 mm



Art. 797/6
 Ø 25 mm
 H 1200 mm
Art. 797/2
 Ø 30 mm
 H 1200 mm
Art. 797/7
 Ø 40 mm
 H 1200 mm

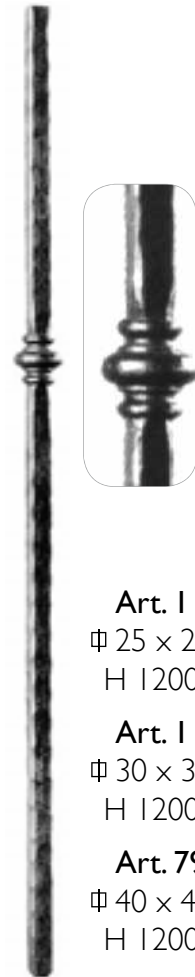

Art. 112/5
 Ø 25 x 25 mm
 H 1200 mm
Art. 112/6
 Ø 30 x 30 mm
 H 1200 mm
Art. 799/3
 Ø 40 x 40 mm
 H 1200 mm



ARTEFERRO

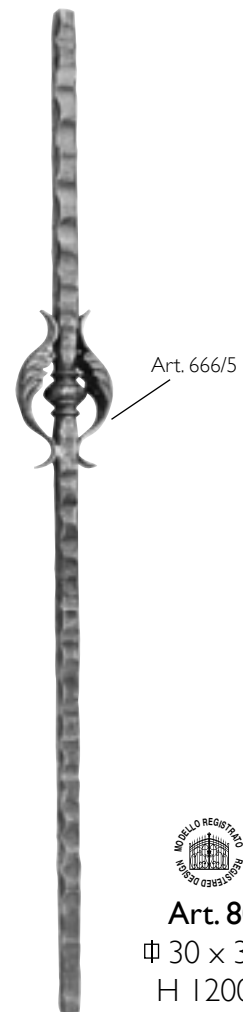

Art. 666/5



Art. 800/1
 Ø 30 x 30 mm
 H 1200 mm

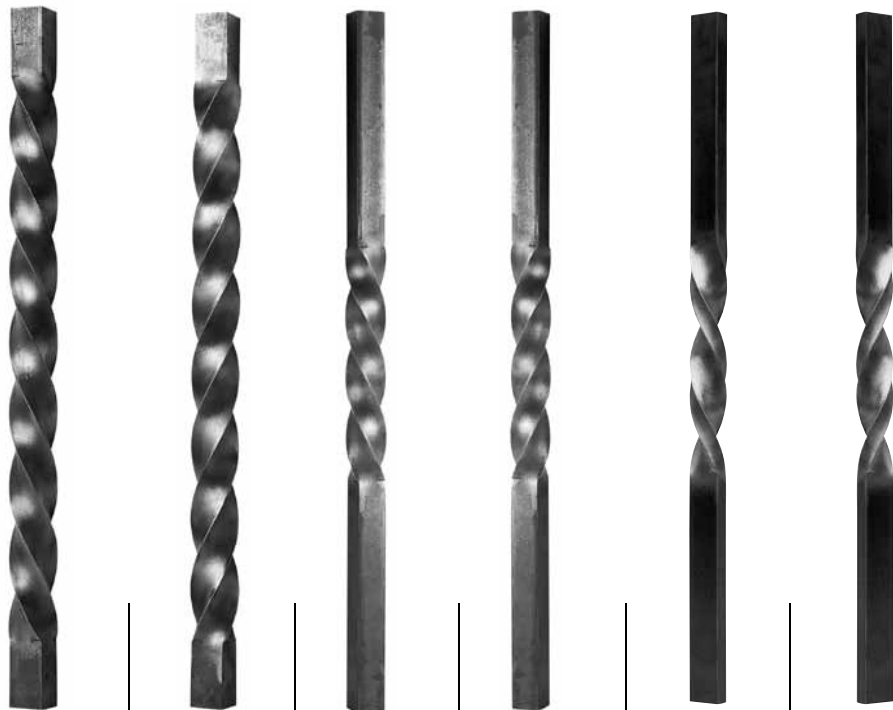

		Attorcigliatura sinistra Twisted to the left	Attorcigliatura destra Twisted to the right	Attorcigliatura sinistra Twisted to the left	Attorcigliatura destra Twisted to the right	Attorcigliatura sinistra Twisted to the left	Attorcigliatura destra Twisted to the right
		Cod.art./Art.no.	Cod.art./Art.no.	Cod.art./Art.no.	Cod.art./Art.no.	Cod.art./Art.no.	Cod.art./Art.no.
Φ 30 × 30 mm	H 1000 mm	119/27	1724/25	1724/31	1724/37		
	H 1200 mm	1724/20	1724/26	1724/32	1724/38		
Φ 40 × 40 mm	H 1000 mm	119/28	1724/23	1724/29	1724/35		
	H 1200 mm	1724/19	1724/24	1724/30	1724/36		
Φ 50 × 50 mm	H 1000 mm	1724/17	1724/21	1724/27	1724/33		
	H 1200 mm	1724/18	1724/22	1724/28	1724/34		
⊘ 50 × 25 mm	H 1000 mm	1724/3	1724/7			1724/11	1724/15
	H 1200 mm	1724/4	1724/8			1724/12	1724/16
⊘ 60 × 30 mm	H 1000 mm	1724/1	1724/5			1724/9	1724/13
	H 1200 mm	1724/2	1724/6			1724/10	1724/14



		Attorcigliatura sinistra Twisted to the left	Attorcigliatura destra Twisted to the right	Attorcigliatura sinistra Twisted to the left	Attorcigliatura destra Twisted to the right
		Cod.art./Art.no.	Cod.art./Art.no.	Cod.art./Art.no.	Cod.art./Art.no.
Φ 30 × 30 mm	H 1000 mm	1724/43	1724/49	1724/55	1724/61
	H 1200 mm	1724/44	1724/50	1724/56	1724/62
Φ 40 × 40 mm	H 1000 mm	1724/41	1724/47	1724/53	1724/59
	H 1200 mm	1724/42	1724/48	1724/54	1724/60
Φ 50 × 50 mm	H 1000 mm	1724/39	1724/45	1724/51	1724/57
	H 1200 mm	1724/40	1724/46	1724/52	1724/58



		Attorcigliatura sinistra Twisted to the left	Attorcigliatura destra Twisted to the right	Attorcigliatura sinistra Twisted to the left	Attorcigliatura destra Twisted to the right
		Cod.art./Art.no.	Cod.art./Art.no.	Cod.art./Art.no.	Cod.art./Art.no.
Φ 30 × 30 mm	H 1000 mm	1725/5	1725/11	1725/17	1725/23
	H 1200 mm	1725/6	1725/12	1725/18	1725/24
Φ 40 × 40 mm	H 1000 mm	1725/3	1725/9	1725/15	1725/21
	H 1200 mm	1725/4	1725/10	1725/16	1725/22
Φ 50 × 50 mm	H 1000 mm	1725/1	1725/7	1725/13	1725/19
	H 1200 mm	1725/2	1725/8	1725/14	1725/20

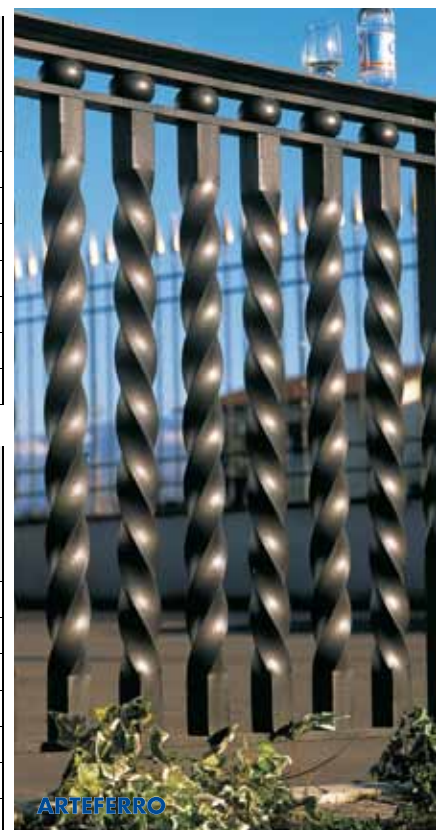



ARTEFERRO



	H 1100 mm	H 1200 mm	H 1200 mm	H 1200 mm	H 1000 mm	H 1200 mm	H 1200 mm
Cod.art./Art.no.	Cod.art./Art.no.	Cod.art./Art.no.	Cod.art./Art.no.	Cod.art./Art.no.	Cod.art./Art.no.	Cod.art./Art.no.	Cod.art./Art.no.
Ø 20 x 20 mm	113/7		639/5		119/25	113/5	
Ø 25 x 25 mm		112/3			119/26		1730/17
Ø 30 x 30 mm	113/8	112/4		GD22/6	119/27	113/6	



ARTEFERRO

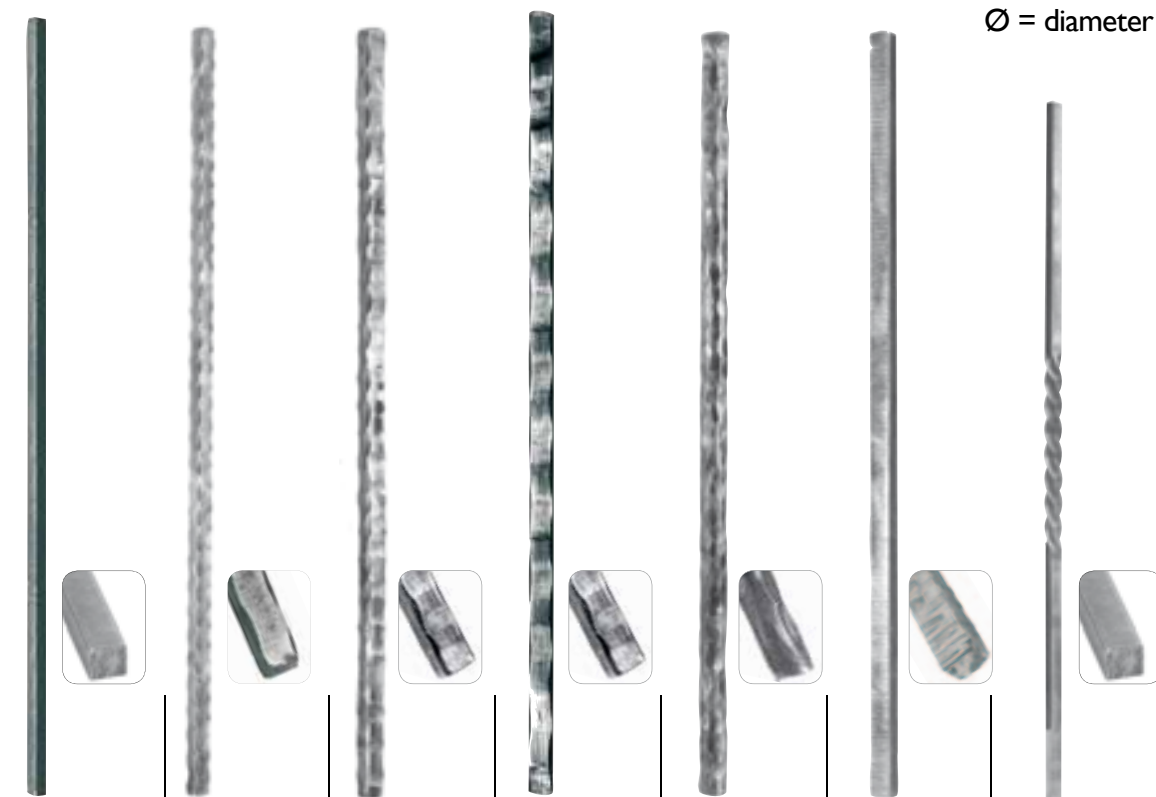

Ø = diameter

	H 1200 mm	H 1100 mm	H 1100 mm	H 1200 mm	H 1100 mm	H 1100 mm	H 1000 mm
Cod.art./Art.no.	Cod.art./Art.no.	Cod.art./Art.no.	Cod.art./Art.no.	Cod.art./Art.no.	Cod.art./Art.no.	Cod.art./Art.no.	Cod.art./Art.no.
Ø 20 x 20 mm		112/B/5	112/B/7			112/B/1	1751/5
Ø 25 x 25 mm	1775/13			1775/15			
Ø 30 x 30 mm	1775/14	112/B/6	112/B/8			112/B/2	
Ø 20 mm					112/B/3		
Ø 30 mm					112/B/4		

Ø = diameter



ARTEFERRO

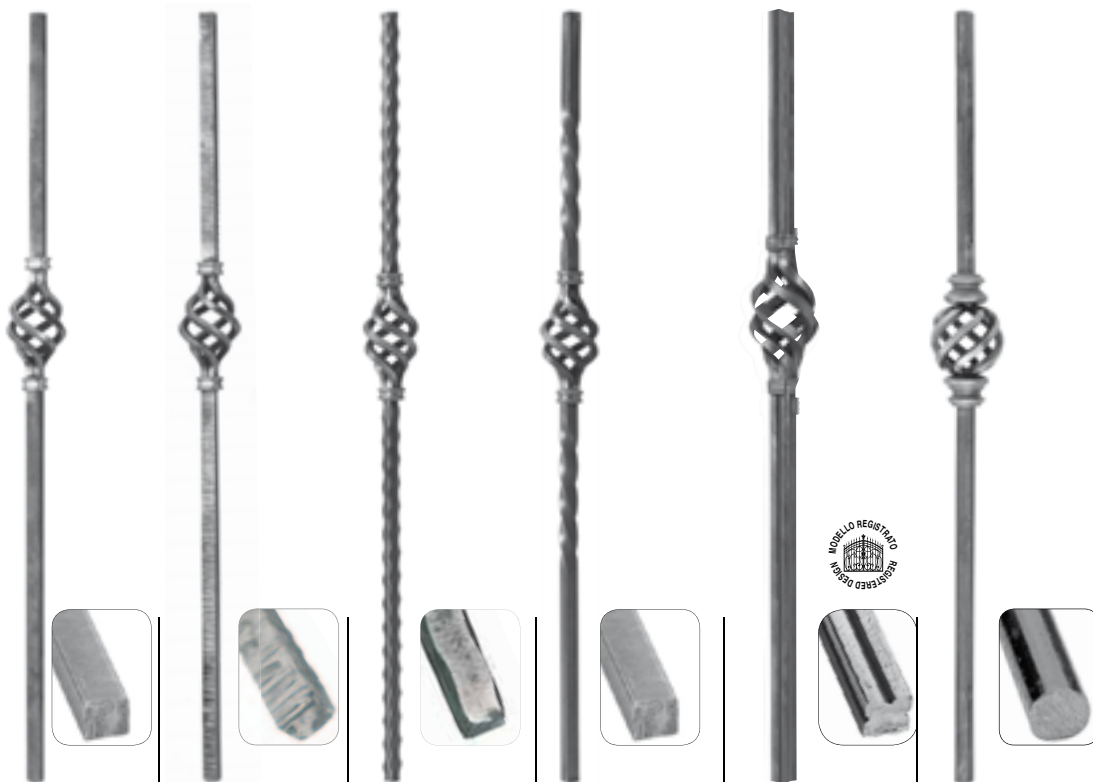

	H 1100 mm	H 1100 mm	H 1100 mm	H 1100 mm	H 1200 mm	H 1200 mm
	Cod.art./Art.no.	Cod.art./Art.no.	Cod.art./Art.no.	Cod.art./Art.no.	Cod.art./Art.no.	Cod.art./Art.no.
Ø 20 x 20 mm	112/B/9	112/B/11	113/3	113/1		
Ø 30 x 30 mm	112/B/10	112/B/12	113/4	113/2	GD13/1	
Ø 30 mm						1204/1



ARTEFERRO

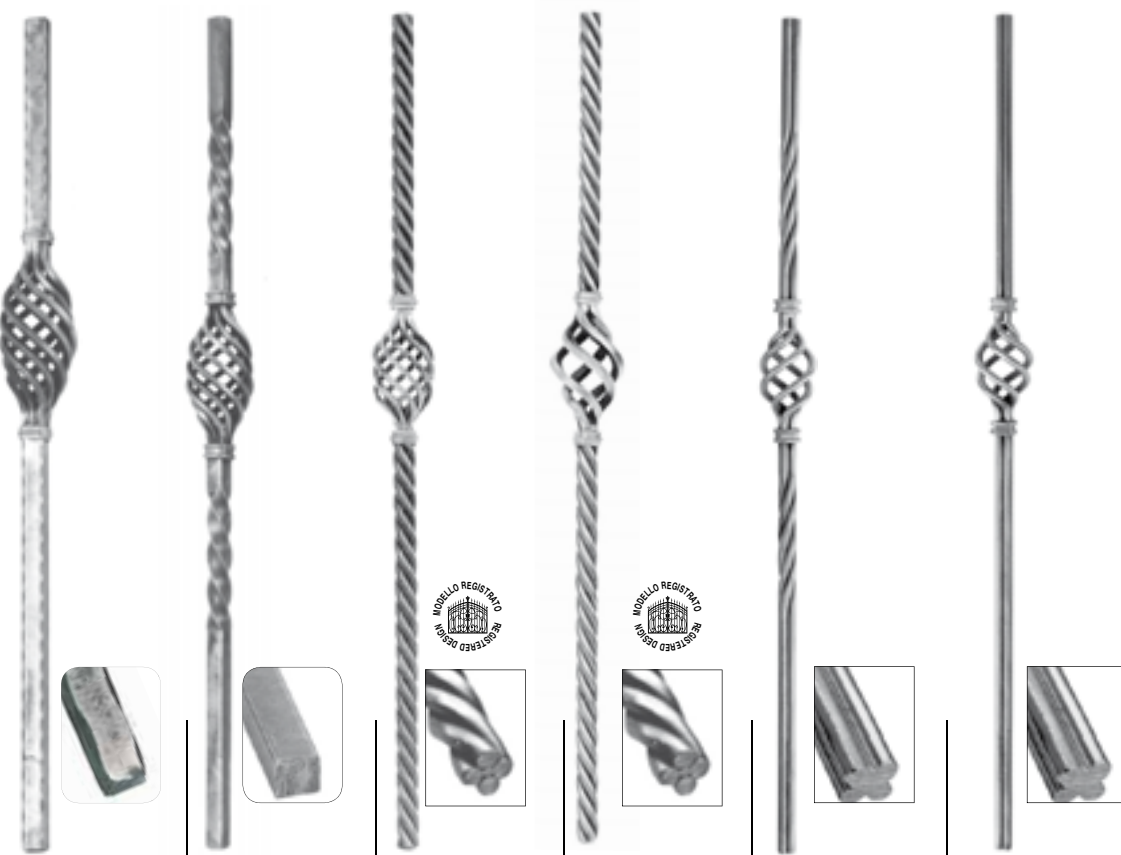

	H 1100 mm	H 1100 mm	H 1100 mm	H 1100 mm	H 1200 mm	H 1200 mm
	Cod.art./Art.no.	Cod.art./Art.no.	Cod.art./Art.no.	Cod.art./Art.no.	Cod.art./Art.no.	Cod.art./Art.no.
Ø 20 x 20 mm	112/B/13	112/B/15				
Ø 24 x 24 mm					1203/2	1203/1
Ø 30 x 30 mm	112/B/14	112/B/16				
Ø 30 mm			801/3	801/4		



Art. 112/1
Φ 25 x 25 mm
H 1200 mm



Art. 797/5
Ø 25 mm
H 1200 mm



Art. 798/1
Ø 30 mm
H 1200 mm



Art. 112/11
Φ 30 x 30 mm
H 1200 mm



Art. 802/3
Ø 25 mm
H 1200 mm

Art. 666/7



Art. 800/3
Ø 30 mm
H 1200 mm



Art. 112/10
Φ 30 x 30 mm
H 1200 mm

Art. 112/2
Φ 30 x 30 mm
H 1200 mm

Art. 797/1
Ø 30 mm
H 1200 mm



Art. 799/1
Φ 25 x 25 mm
H 1100 mm



Art. 798/2
Φ 25 x 25 mm
H 1100 mm



Art. 799/2
Φ 25 x 25 mm
H 1100 mm



Art. 112/9
Φ 30 x 30 mm
H 1200 mm



Art. 666/7



Art. 800/4
Φ 30 x 30 mm
H 1200 mm



ARTEFERRO



Art. 797/3
 Ø 30 mm
 H 1200 mm

Foro filettato DIA 12 MA
 Threaded hole DIA 12 MA



Art. 1198/1
 Ø 30 x 30 mm
 H 500 mm



Art. 1198/2
 Ø 30 mm
 H 500 mm



Borchia forgiata al paletto
 Forged bush to the picket



Art. 1199/1
 Ø 25 x 25 mm
 H 1200 mm



Borchia forgiata al paletto
 Forged bush to the picket



Art. 1199/2
 Ø 25 x 25 mm
 H 1200 mm



Borchia forgiata al paletto
 Forged bush to the picket

Art. 1199/3
 Ø 26 mm
 H 1200 mm



Art. 1199/4
 Ø 25 x 25 mm
 H 1200 mm

Art. 1199/5
 Ø 30 x 30 mm
 H 1200 mm



Art. 1206/1
 Ø 30 x 30 mm
 H 1200 mm
 L 270 mm



Art. 802/2
 25 x 12 mm
 H 650 mm
 L 270 mm



Art. 802/1
 Ø 30 x 30 mm
 H 1000 mm
 L 350 mm



ARTEFERRO



Sfera
vuota
Ø 80 mm
Hollow
sphere
Ø 80 mm



- Art. 1775/10**
Ø 20 x 20 mm
H 1200 mm
- Art. 1775/11**
Ø 25 x 25 mm
H 1200 mm
- Art. 1775/12**
Ø 30 x 30 mm
H 1200 mm
- Art. 1775/3**
Ø 20 x 20 mm
H 1200 mm
- Art. 1775/4**
Ø 25 x 25 mm
H 1200 mm
- Art. 1775/5**
Ø 20 x 20 mm
H 1200 mm
- Art. 1775/6**
Ø 25 x 25 mm
H 1200 mm
- Art. 1775/1**
Ø 25 mm
H 1200 mm
- Art. 1775/2**
Ø 30 mm
H 1200 mm
- Art. 1205/1**
Ø 25 mm
H 1200 mm
- Art. 64/1/1**
Ø 25 x 25 mm
H 1200 mm
- Art. 1205/2**
Ø 25 mm
H 1200 mm



ARTEFERRO

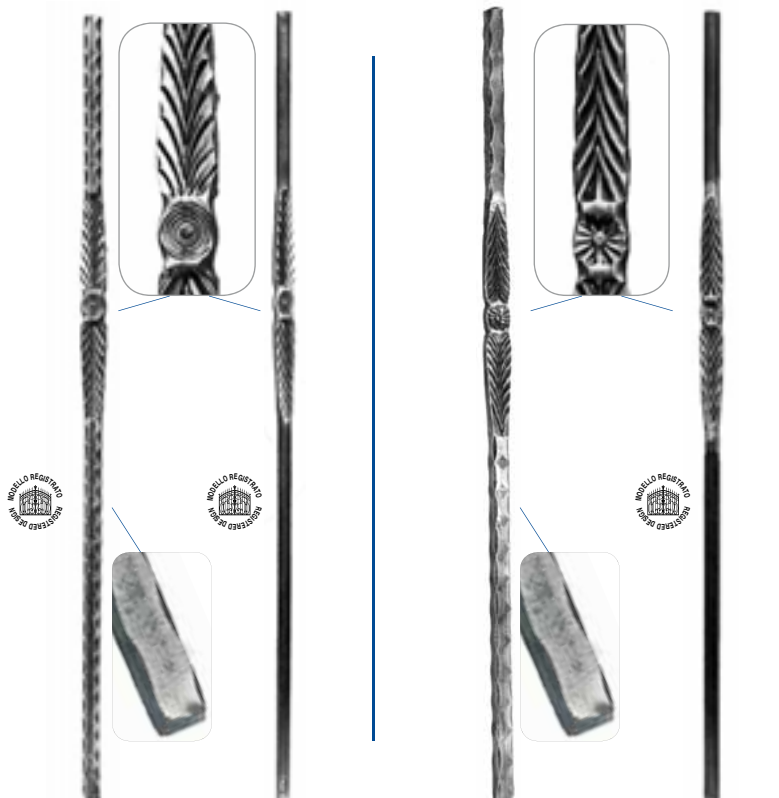

- Art. 801/2**
Ø 25 x 25 mm
H 1200 mm
- Art. 801/5**
Ø 25 mm
H 1200 mm
- Art. 801/8**
Ø 30 mm
H 1200 mm
- Art. 64/F/1**
Ø 25 x 25 mm
H 1200 mm
- Art. 801/1**
Ø 25 mm
H 1200 mm
- Art. 801/7**
Ø 30 mm
H 1200 mm

CAPOSALDI - NEWEL POSTS



Art. 1701/15
 Φ 25 x 25 mm
 H 1200 mm



Art. 1777/2
 Φ 25 mm
 H 1200 mm

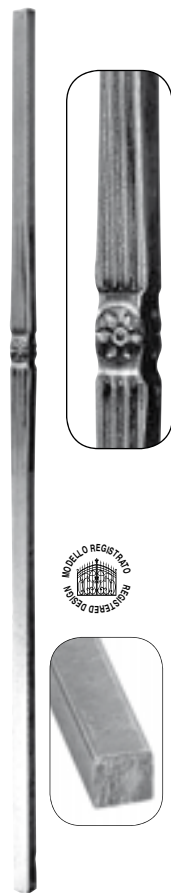

Art. 1705/15
 Φ 25 x 25 mm
 H 1200 mm



Art. 1777/1
 Φ 25 mm
 H 1200 mm

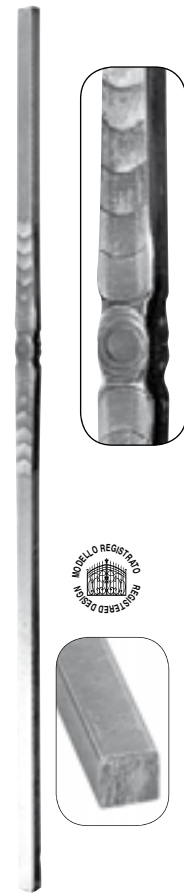

Art. 1702/15
 Φ 25 x 25 mm
 H 1200 mm



Art. 1777/3
 Φ 25 mm
 H 1200 mm



Art. 1777/6
 Φ 25 x 25 mm
 H 1200 mm



Art. 1777/7
 Φ 25 x 25 mm
 H 1200 mm

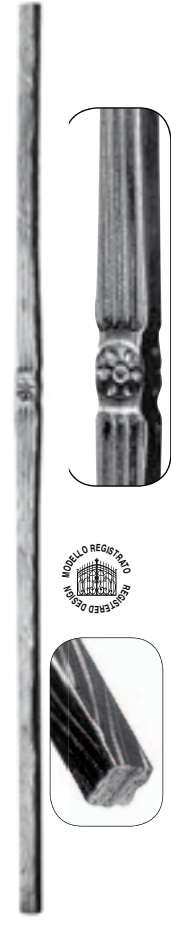

Art. 1777/4
 Φ 25 x 25 mm
 H 1200 mm



Art. 1777/9
 Φ 25 x 25 mm
 H 1200 mm

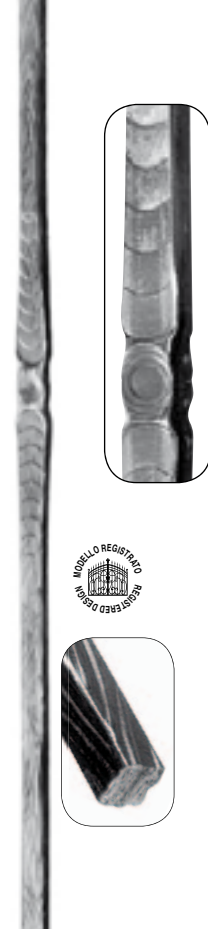

Art. 1777/5
 Φ 25 x 25 mm
 H 1200 mm

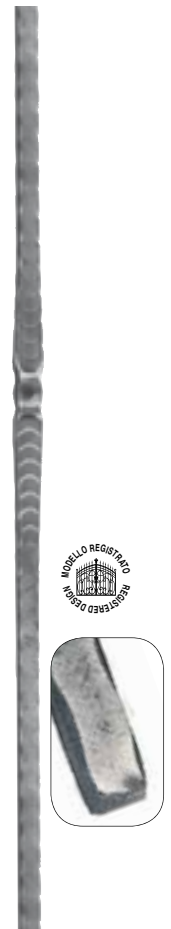

Art. 1777/8
 Φ 25 x 25 mm
 H 1200 mm



ARTEFERRO

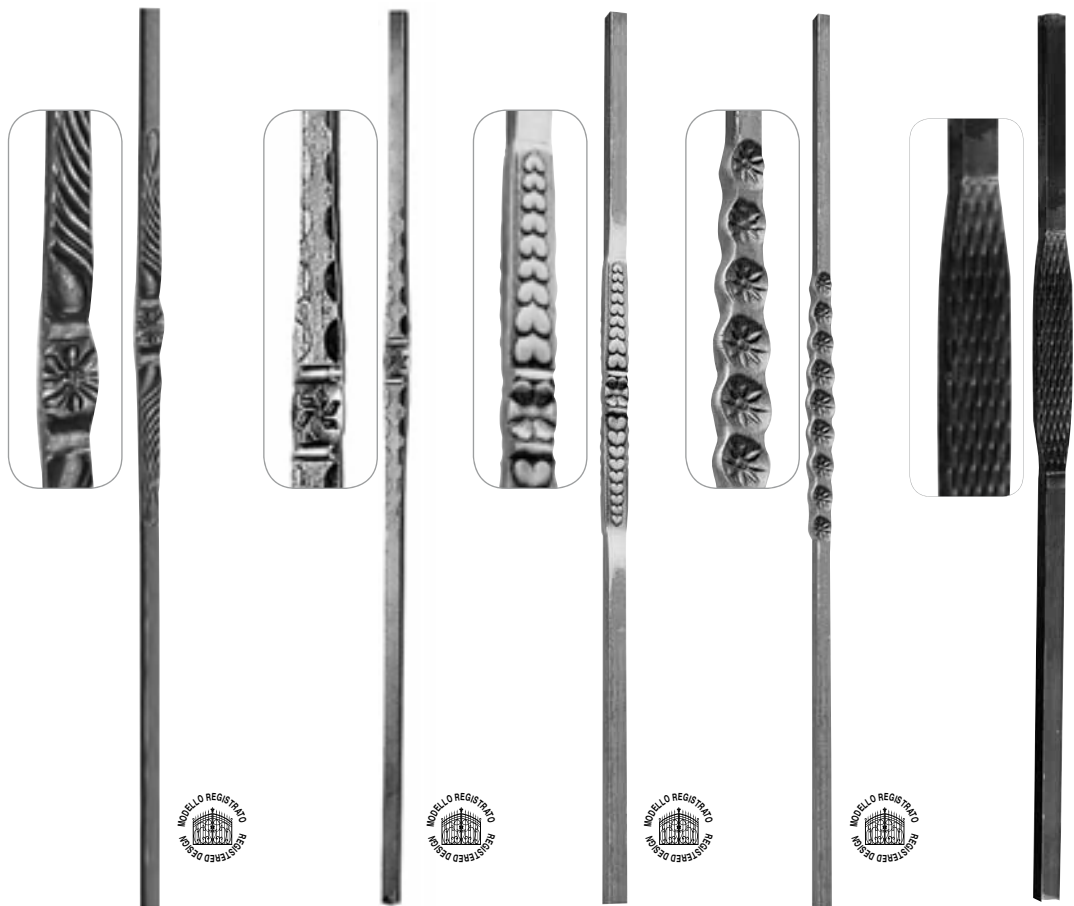

Art. NEW0028
 Φ 25 x 25 mm
 H 1200 mm

Art. NEW0039
 Φ 25 x 25 mm
 H 1200 mm

Art. 1718/17
 Φ 25 x 25 mm
 H 1200 mm

Art. 1718/18
 Φ 25 x 25 mm
 H 1200 mm

Art. 1775/7
 Φ 20 x 20 mm
 H 1200 mm

Art. 1775/8
 Φ 25 x 25 mm
 H 1200 mm

Art. 1775/9
 Φ 30 x 30 mm
 H 1200 mm



ARTEFERRO



Tubo
 60 x 60 mm
 Tube
 60 x 60 mm

Tubo
 80 x 80 mm
 Tube
 80 x 80 mm

Tubo
 Φ 75 mm
 Tube
 Φ 75 mm

Tubo
 Φ 100 mm
 Tube
 Φ 100 mm

Art. 1207/1
 H 1200 mm
 L 85 mm
Art. 1246/1
 H 1000 mm
 L 85 mm

Art. 1207/2
 H 1200 mm
 L 105 mm
Art. 1246/2
 H 1000 mm
 L 105 mm

Art. 1207/3
 H 1200 mm
 Φ 100 mm
Art. 1247/1
 H 1000 mm
 Φ 100 mm

Art. 1207/4
 H 1200 mm
 Φ 135 mm
Art. 1247/2
 H 1000 mm
 Φ 135 mm

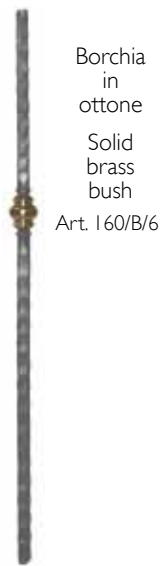

Borchia in ottone
Solid brass bush
Art. 160/B/6

Art. 111/3
Ø 30 x 30 mm
H 1200 mm

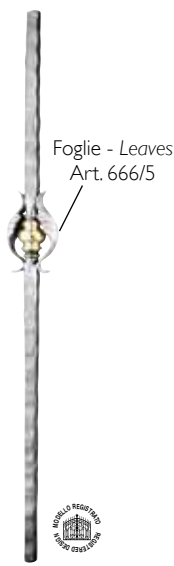

Foglie - Leaves
Art. 666/5

Art. 805/2
Ø 30 x 30 mm
H 1200 mm



Pigna in ottone
Solid brass basket

Art. 1149/7
Ø 20 x 20 mm
H 1200 mm



Art. 1149/8
Ø 20 x 20 mm
H 1200 mm

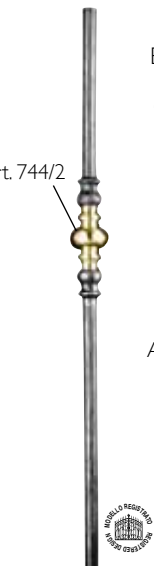

Art. 744/2

Borchia in ottone
Solid brass bush

Art. 805/1
Ø 30 mm
H 1200 mm

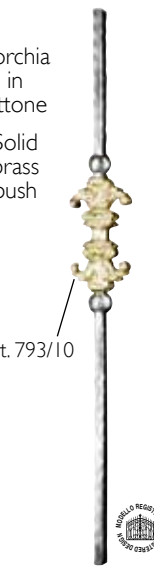

Art. 793/10

Art. 804/1
Ø 30 x 20 mm
H 1200 mm

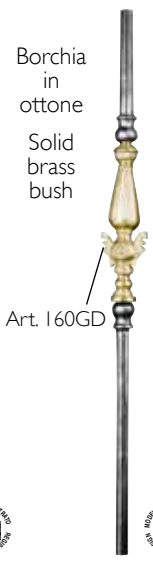

Art. 160GD

Art. 804/2
Ø 30 mm
H 1200 mm



Borchia art. 128/B/2
Bush art. 128/B/2



Art. 118/H/27
Ø 20 mm
H 900 mm
Art. 118/H/28
Ø 20 mm
H 1200 mm

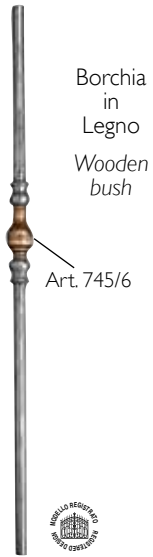

Borchia in Legno
Wooden bush

Art. 745/6

Art. 807/1
Ø 30 mm
H 1200 mm



Art. 745/7

Art. 807/2
Ø 30 mm
H 1200 mm



Borchia in ottone
Solid brass bush
Art. 160/42

Art. 145/3
Ø 40 mm
H 1000 mm



Borchia in ottone
Solid brass bush
Art. 160/42

Art. 145/4
Ø 40 mm
H 1200 mm



Borchia e pomolo in ottone
Brass Post Top and bush

Art. 160/44

Art. 160/42

Art. 145/5
Ø 40 mm
H 1300 mm



Borchia in ottone
Solid brass bush

Art. 160/42

Art. 1794/5
Ø 40 mm
H 1000 mm



Art. 160/42

Art. 1794/6
Ø 40 mm
H 1200 mm



Tubo rigato
Grooved tube

Art. 1794/8
Ø 40 mm
H 1200 mm



Borchia in Legno
Wooden bush

Art. 745/8

Art. 807/3
Ø 30 mm
H 1200 mm



Art. 745/6

Art. 807/4
Ø 30 mm
H 1200 mm



Borchia in Legno
Wooden bush

Art. 745/7

Art. 806/1
Ø 40 mm
H 1200 mm



Borchia in Legno
Wooden bush

Art. 745/6

Art. 806/2
Ø 40 mm
H 1200 mm



Borchia in Legno
Wooden bush

Art. 745/8

Art. 806/3
Ø 40 mm
H 1200 mm



Borchia in Legno
Wooden bush

Art. 745/7

Art. 806/4
Ø 40 mm
H 1200 mm



Borchia in Legno
Wooden bush

Art. 745/11

Art. 806/5
Ø 40 mm
H 1200 mm



Borchia in Legno
Wooden bush

Art. 745/10

Art. 806/6
Ø 40 mm
H 1200 mm



CORRIMANO E BARRE LUNGHE - HANDRAIL AND LONG BARS COMPENDIUM 2011

810/B/13
1377/38
1817/12
114/B/1
812/5

CORRIMANO LAMINATO A CALDO
HOT ROLLED HANDRAIL



Sezione Section	L 3000 mm	L 6000 mm
	Cod.art./Art.no.	Cod.art./Art.no.
40 x 11 mm	1373/4	1373/4/6000
45 x 12 mm	1373/3	1373/3/6000
50 x 14 mm	114/A/3	114/A/3/6000
60 x 16 mm	1373/2	1373/2/6000



Per corrimano For handrail	X 130 mm Y 110 mm
Cod.art./Art.no.	Cod.art./Art.no.
1373/4	1817/9
1373/3	1817/10
114/A/3	114/B/13
1373/2	1817/12

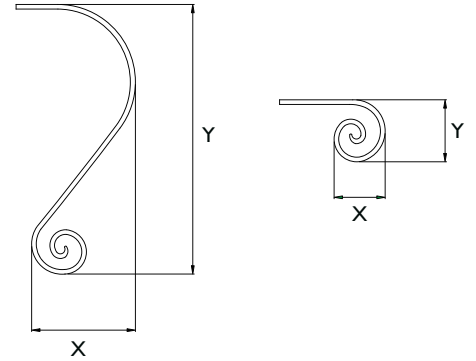

Per corrimano For handrail	X 130 mm Y 110 mm
Cod.art./Art.no.	Cod.art./Art.no.
1373/4	1377/25
1373/3	1377/24
1373/2	1377/23



Per corrimano For handrail	X 110 mm Y 300 mm
Cod.art./Art.no.	Cod.art./Art.no.
1373/4	1817/5
1373/3	1817/6
114/A/3	114/B/14
1373/2	1817/8



Per corrimano For handrail	X 150 mm Y 130 mm
Cod.art./Art.no.	Cod.art./Art.no.
1373/4	1814/17
1373/3	1814/16
114/A/3	1814/18
1373/2	1814/15

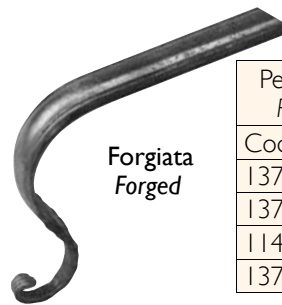

Per corrimano For handrail	X 100 mm Y 300 mm
Cod.art./Art.no.	Cod.art./Art.no.
1373/4	1814/11
1373/3	1814/10
114/A/3	1814/12
1373/2	1814/9



Per corrimano For handrail	X 160 mm Y 730 mm
Cod.art./Art.no.	Cod.art./Art.no.
1373/4	1377/38
1373/3	1377/37
1373/2	1377/36

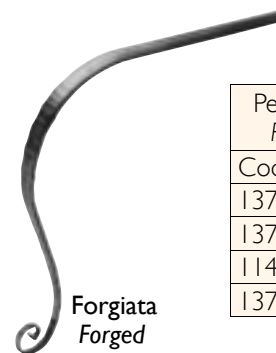

Per corrimano For handrail	X 160 mm Y 730 mm
Cod.art./Art.no.	Cod.art./Art.no.
1373/4	1814/5
1373/3	1814/4
114/A/3	1814/6
1373/2	1814/3



Per articolo For Item #	Ø esterno External Dia. 325 mm
Cod.art./Art.no.	Cod.art./Art.no.
1373/4	1822/2
1373/3	1822/3
114/A/3	1822/1
1373/2	1822/4



Per articolo For Item #	Ø esterno External Dia. 325 mm
Cod.art./Art.no.	Cod.art./Art.no.
1373/4	1822/13
1373/3	1822/14
114/A/3	1822/12
1373/2	1822/15



Per corrimano For handrail	X 160 mm Y 730 mm
Cod.art./Art.no.	Cod.art./Art.no.
1373/4	1817/1
1373/3	1817/2
114/A/3	114/B/15
1373/2	1817/3

LAMINATO A CALDO
HOT ROLLED

Sezione Section	L 3000 mm	L 6000 mm
	Cod.art./Art.no.	Cod.art./Art.no.
∅ 25 x 7 mm	158/9/C	158/9/C/6000
∅ 30 x 8 mm	158/10/C	158/10/C/6000
∅ 30 x 10 mm	810/A/1	810/A/10
∅ 35 x 10 mm	810/A/2	810/A/11
∅ 35 x 15 mm	810/A/23	810/A/24
∅ 40 x 8 mm	158/12/C	158/12/C/6000
∅ 40 x 10 mm	810/A/3	810/A/12
∅ 40 x 12 mm	810/7/C	810/7/C/6000
∅ 40 x 15 mm	810/A/4	810/A/13
∅ 45 x 10 mm	158/47/C	158/47/C/6000
∅ 50 x 8 mm	158/45/C	158/45/C/6000
∅ 50 x 10 mm	810/A/5	810/A/14
∅ 50 x 12 mm	810/8/C	810/8/C/6000
∅ 50 x 15 mm	810/A/6	810/A/15
∅ 50 x 20 mm	810/A/7	810/A/16
∅ 60 x 20 mm	810/A/9	810/A/18

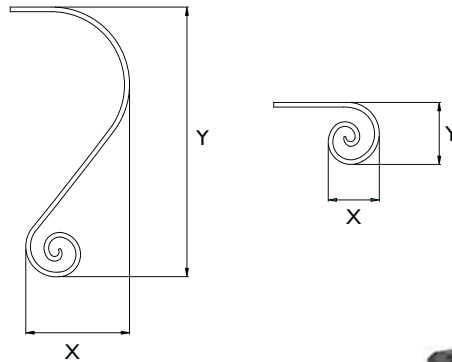

MEZZITONDI VERI
laminati a caldo
Hot rolled
HALF ROUND SECTION

Sezione Section	L 3000 mm	L 6000 mm
	Cod.art./Art.no.	Cod.art./Art.no.
∅ 20 x 10 mm	810/1	810/1/6000
∅ 25 x 12,5 mm	810/2	810/2/6000
∅ 30 x 15 mm	810/3	810/10
∅ 40 x 20 mm	810/5	810/11
∅ 50 x 25 mm	810/12	810/12/6000
∅ 60 x 30 mm	810/13	810/13/6000

per/For	X 130 mm Y 110 mm
	Cod.art./Art.no.
∅ 35 x 10 mm	812/5
∅ 40 x 8 mm	812/6
∅ 40 x 10 mm	812/7
∅ 40 x 12 mm	1819/25
∅ 45 x 10 mm	1819/27
∅ 50 x 8 mm	1819/26
∅ 50 x 10 mm	812/8
∅ 50 x 12 mm	1819/28

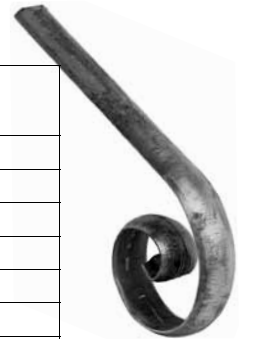

per/For	X 100 mm Y 300 mm
	Cod.art./Art.no.
∅ 35 x 10 mm	812/1
∅ 40 x 8 mm	812/2
∅ 40 x 10 mm	812/3
∅ 40 x 12 mm	1819/21
∅ 45 x 10 mm	1819/23
∅ 50 x 8 mm	1819/22
∅ 50 x 10 mm	812/4
∅ 50 x 12 mm	1819/24



per/For	X 110 mm Y 730 mm
	Cod.art./Art.no.
∅ 35 x 10 mm	1819/13
∅ 40 x 8 mm	1819/14
∅ 40 x 10 mm	1819/15
∅ 40 x 12 mm	1819/17
∅ 45 x 10 mm	1819/19
∅ 50 x 8 mm	1819/18
∅ 50 x 10 mm	1819/16
∅ 50 x 12 mm	1819/20

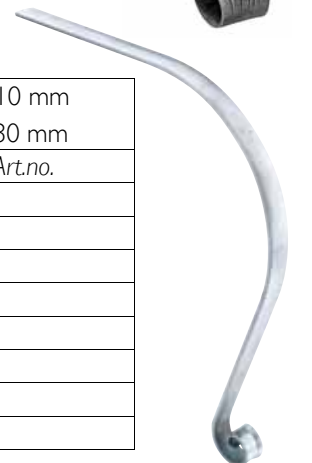

ARTEFERRO

CORRIMANO e BARRE LUNGHE - HANDRAIL and LONG BARS

LAMINATO A CALDO
HOT ROLLED



811/2
 \varnothing 58 x 16 mm
 L 4000 mm



ARTEFERRO

Forgiata
Forged



1814/14
 Per/For 811/2
 X 150 mm
 Y 130 mm

Forgiata
Forged



1814/8
 Per/For 811/2
 X 100 mm
 Y 300 mm

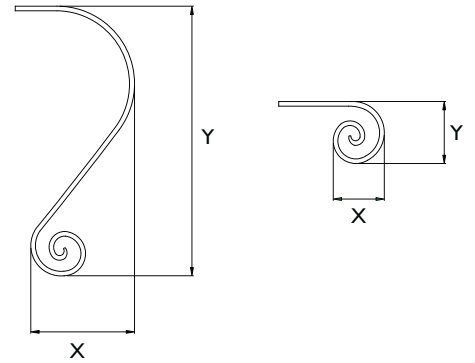

1817/11
 Per/For 811/2
 X 110 mm
 Y 130 mm



1817/7
 Per/For 811/2
 X 110 mm
 Y 300 mm



\varnothing esterno
External Dia.
325 mm

1822/17
 Per/For 811/2

Forgiata
Forged

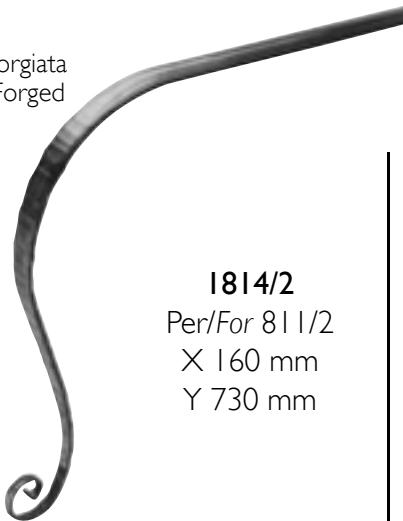

1814/2
 Per/For 811/2
 X 160 mm
 Y 730 mm

H 800 mm
 L 200 mm



1817/4
 Per/For 811/2
 X 110 mm
 Y 730 mm



\varnothing esterno
External Dia.
325 mm

1822/6
 Per/For 811/2

LAMINATO A CALDO
HOT ROLLED

Dimensioni Dimensions	L 3000 mm	L 6000 mm
	Cod.art./Art.no.	Cod.art./Art.no.
☒ 43 x 15 mm	811/4	811/7
☒ 43 x 19 mm	811/5	811/8
☒ 56 x 21 mm	811/3	811/6

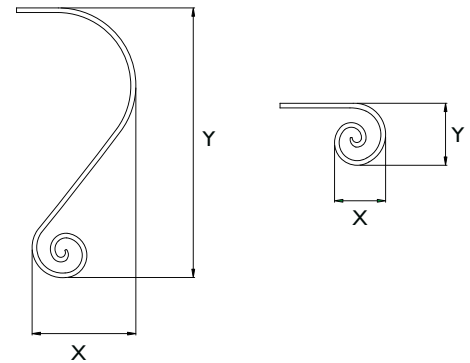

Per corrimano For handrail	Per corrimano For handrail	X 110 mm Y 300 mm
Cod.art./Art.no.	Cod.art./Art.no.	Cod.art./Art.no.
811/4	811/7	1377/41
811/5	811/8	1377/42
811/3	811/6	1377/40



Per corrimano For handrail	Per corrimano For handrail	X 130 mm Y 110 mm
Cod.art./Art.no.	Cod.art./Art.no.	Cod.art./Art.no.
811/4	811/7	812/13
811/5	811/8	812/15
811/3	811/6	812/12



Per corrimano For handrail	Per corrimano For handrail	X 110 mm Y 730 mm
Cod.art./Art.no.	Cod.art./Art.no.	Cod.art./Art.no.
811/4	811/7	1819/11
811/5	811/8	1819/12
811/3	811/6	1819/10

CORRIMANO e BARRE LUNGHE - HANDRAIL and LONG BARS

LAMINATO A CALDO
HOT ROLLED

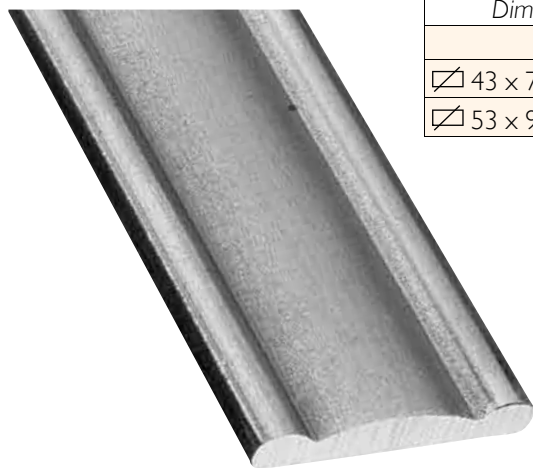

Dimensioni Dimensions	L 3650 mm
	Cod.art./Art.no.
43 x 7 mm	114/A/1
53 x 9 mm	114/A/2

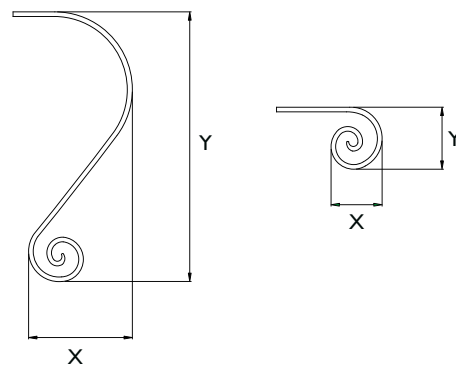

Per articolo For Item #	Ø esterno External Dia. 325 mm
114/A/1	1822/7
114/A/2	1822/8



Per articolo For Item #	Ø esterno External Dia. 325 mm
	Cod.art./Art.no.
114/A/1	1822/18
114/A/2	1822/19



Per corrimano For handrail	X 130 mm Y 110 mm
	Cod.art./Art.no.
114/A/1	1818/15
114/A/2	1818/16



Per corrimano For handrail	X 110 mm Y 300 mm
	Cod.art./Art.no.
114/A/1	114/B/1
114/A/2	114/B/2



Per corrimano For handrail	X 110 mm Y 730 mm
	Cod.art./Art.no.
114/A/1	1818/5
114/A/2	1818/6



ARTEFERRO

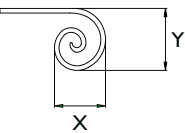
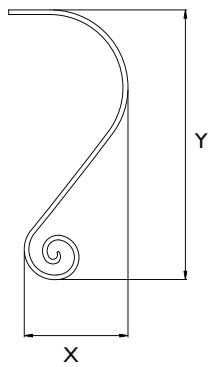

Art. 114/B/3
Per/For Art.114/2
X 160 mm
Y 730 mm
forgiata
Hor forged

Art. 115/3
Per/For Art.114/2
X 150 mm
Y 130 mm
forgiata
Hor forged

Art. 115/2
Per/For Art.114/2
X 100 mm
Y 300 mm
forgiata
Hor forged

Fucinato al maglio
Hot hammered
L 2000 mm

Art. 114/2
Ø 58 x 17 mm



Ø esterno
External Dia.
325 mm

Art. 1822/21
Per/For Art.114/2



Ø esterno
External Dia.
325 mm

Art. 1822/10
Per/For Art.114/2



LAMINATO A FREDDO
COLD ROLLED

Dimensioni Dimensions	L 3000 mm	L 6000 mm
	Cod.art./Art.no.	Cod.art./Art.no.
Ø 59 x 16,5 mm	811/3/T	811/6/T



Ø esterno
External Dia.
205 mm

Art. 1825/26
Per/For 811/3/T
Per/For 811/6/T



Ø esterno
External Dia.
205 mm

Art. 1825/16
Per/For 811/3/T
Per/For 811/6/T

Art. 1820/9
Per/For 811/3/T
Per/For 811/6/T
X 110 mm
Y 730 mm

Art. 1377/40/T
Per For 811/3/T
Per/For 811/6/T
X 110 mm
Y 300 mm

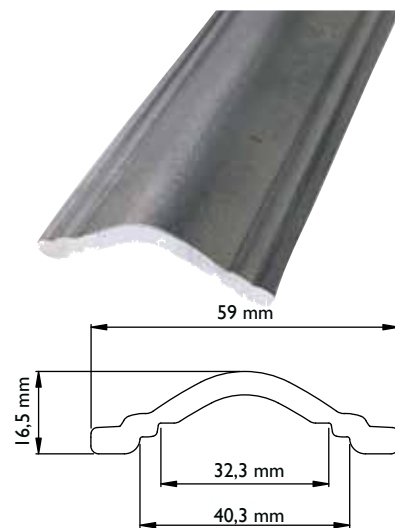

Art. 812/12/T
Per/For 811/3/T
Per/For 811/6/T
X 130 mm
Y 110 mm



ARTEFERRO

LAMINATO A FREDDO
COLD ROLLED

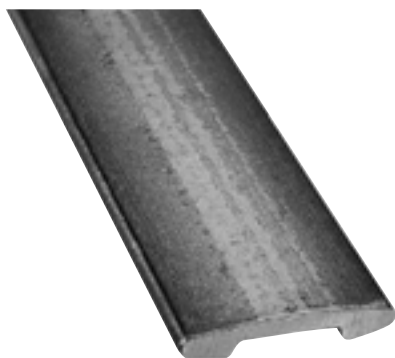

Dimensioni Dimensions	C	L 3000 mm	L 6000 mm
		Cod.art./Art.no.	Cod.art./Art.no.
40 x 8,5 mm	20,7 mm	810/B/13/T	810/B/16/T
45 x 9 mm	20,8 mm	810/B/14/T	810/B/17/T
50 x 9 mm	25,7 mm	810/B/15/T	810/B/18/T

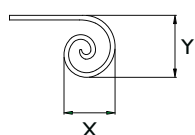
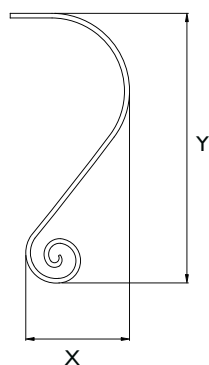
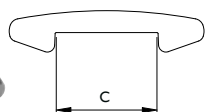

X 130 mm
Y 110 mm



X 110 mm
Y 300 mm



X 110 mm
Y 730 mm



Dimensioni Dimensions	Cod.art./Art.no.	Cod.art./Art.no.	Cod.art./Art.no.
per/For 40 x 8,5 mm	1377/20/T	1377/7/T	1820/5
per/For 45 x 9 mm	1377/21/T	1377/8/T	1820/6
per/For 50 x 9 mm	1377/22/T	1377/9/T	1820/7



Dimensioni Dimensions	Ø esterno External Dia. 205 mm
	Cod.art./Art.no.
per/For 40 x 8,5 mm	1825/13
per/For 45 x 9 mm	1825/14
per/For 50 x 9 mm	1825/15

Dimensioni Dimensions	Ø esterno External Dia. 205 mm
	Cod.art./Art.no.
per/For 40 x 8,5 mm	1825/23
per/For 45 x 9 mm	1825/24
per/For 50 x 9 mm	1825/25

LAMINATO A FREDDO
COLD ROLLED

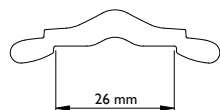
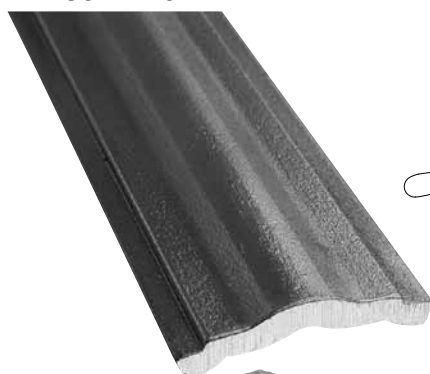

Dimensioni Dimensions	L 3000 mm	L 6000 mm
	Cod.art./Art.no.	Cod.art./Art.no.
43 x 11 mm	810/B/19/T	810/B/20/T

Art. 1377/18/T
Per/For 810/B/19/T
Per/For 810/B/20/T
X 130 mm
Y 110 mm



Art. 1377/5/T
Per/For 810/B/19/T
Per/For 810/B/20/T
X 110 mm
Y 300 mm



Art. 1820/8
Per/For 810/B/19/T
Per/For 810/B/20/T
X 110 mm
Y 730 mm



Dimensioni Dimensions	L 3000 mm	L 6000 mm
	Cod.art./Art.no.	Cod.art./Art.no.
☒ 44,5 x 14,5 mm	810/B/21	810/B/22

LAMINATO A CALDO
HOT ROLLED



ARTEFERRO

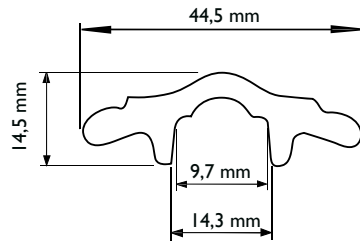

Art. 1377/19
Per/For 810/B/21
Per/For 810/B/22
X 130 mm
Y 110 mm



Art. 1377/6
Per/For 810/B/21
Per/For 810/B/22
X 110 mm
Y 300 mm



Art. 1819/6
Per/For 810/B/21
Per/For 810/B/22
X 110 mm
Y 730 mm



Art. 1819/32
Per/For 810/B/21
Per/For 810/B/22
X 110 mm
Y 730 mm

Dimensioni Dimensions	C	L 3000 mm	L 6000 mm
		Cod.art./Art.no.	Cod.art./Art.no.
☒ 40 x 8,5 mm	21,5 mm	810/B/13	810/B/16
☒ 45 x 9,5 mm	21,5 mm	810/B/14	810/B/17
☒ 55 x 10,5 mm	26,5 mm	810/B/15	810/B/18

LAMINATO A CALDO
HOT ROLLED

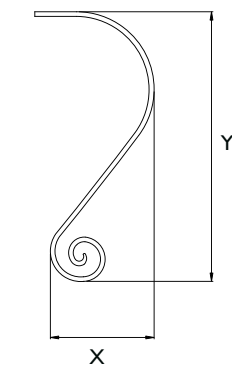
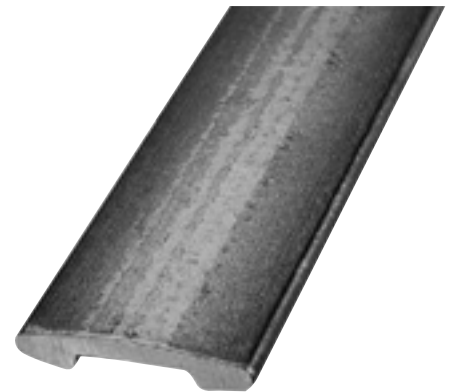
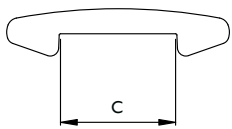

X 110 mm
Y 730 mm

X 110 mm
Y 730 mm

X 110 mm
Y 300 mm

X 130 mm
Y 110 mm

Dimensioni
Dimensions



Dimensioni Dimensions	Cod.art./Art.no.	Cod.art./Art.no.	Cod.art./Art.no.	Cod.art./Art.no.
per/For ☒ 40 x 8,5 mm	1377/33	1819/7	1377/7	1377/20
per/For ☒ 45 x 9,5 mm	1377/34	1819/8	1377/8	1377/21
per/For ☒ 55 x 10,5 mm	1377/35	1819/9	1377/9	1377/22

**LAMINATO A FREDDO
COLD ROLLED**

Dimensioni Dimensions	C	L 3000 mm	L 6000 mm
		Cod.art./Art.no.	Cod.art./Art.no.
35 x 9 mm	15 mm	810/B/1/T	810/B/5/T
41 x 9 mm	21,1 mm	810/B/2/T	810/B/6/T
45 x 14 mm	20,8 mm	810/B/3/T	810/B/7/T
50 x 14 mm	20,7 mm	810/B/4/T	810/B/8/T

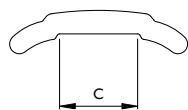

X 130 mm
Y 110 mm

X 110 mm
Y 300 mm

X 110 mm
Y 730 mm

Dimensioni
Dimensions

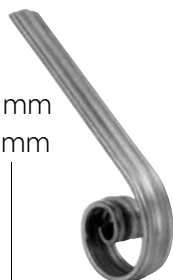

	Cod.art./Art.no.	Cod.art./Art.no.	Cod.art./Art.no.
per/For 35 x 9 mm	1377/14/T	1377/1/T	1820/1
per/For 41 x 9 mm	1377/15/T	1377/2/T	1820/2
per/For 45 x 14 mm	1377/16/T	1377/3/T	1820/3
per/For 50 x 14 mm	1377/17/T	1377/4/T	1820/4

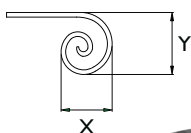
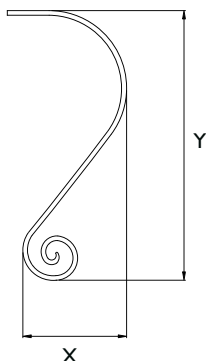

Dimensioni Dimensions	Ø esterno External Dia. 205 mm
	Cod.art./Art.no.
per/For 35 x 9 mm	1825/9
per/For 41 x 9 mm	1825/10
per/For 45 x 14 mm	1825/11
per/For 50 x 14 mm	1825/12

Dimensioni Dimensions	Ø esterno External Dia. 205 mm
	Cod.art./Art.no.
per/For 35 x 9 mm	1825/19
per/For 41 x 9 mm	1825/20
per/For 45 x 14 mm	1825/21
per/For 50 x 14 mm	1825/22

**LAMINATO A FREDDO
COLD ROLLED**

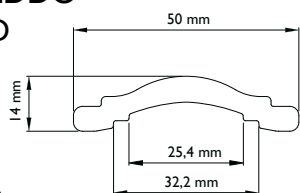
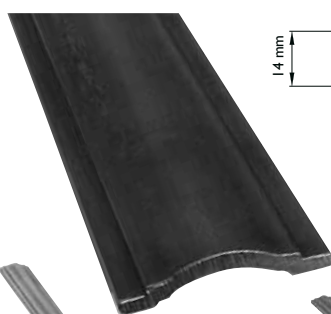

Dimensioni Dimensions	L 3000 mm	L 6000 mm
	Cod.art./Art.no.	Cod.art./Art.no.
50 x 14 mm	811/5/T	811/8/T



Art. 812/15/T
Per/For 811/5/T
Per/For 811/8/T
X 130 mm
Y 110 mm

Art. 1377/42/T
Per/For 811/5/T
Per/For 811/8/T
X 110 mm
Y 300 mm

Art. 1820/11
Per/For 811/5/T
Per/For 811/8/T
X 110 mm
Y 730 mm

Ø esterno
External Dia.
205 mm
Art. 1825/28
Per/For 811/5/T
Per/For 811/8/T

Ø esterno
External Dia.
205 mm
Art. 1825/18
Per/For 811/5/T
Per/For 811/8/T

Dimensioni Dimensions	L 3000 mm	L 6000 mm
	Cod.art./Art.no.	Cod.art./Art.no.
44 x 14 mm	810/B/19	810/B/20

LAMINATO A CALDO
HOT ROLLED

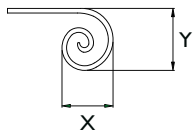
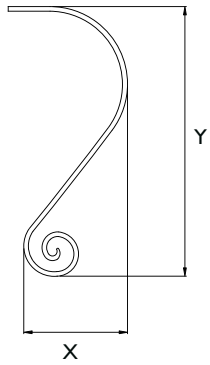
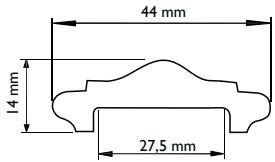

1377/18
Per/For 810/B/19
Per/For 810/B/20
X 130 mm
Y 110 mm



1377/5
Per/For 810/B/19
Per/For 810/B/20
X 110 mm
Y 300 mm



1377/31
Per/For 810/B/19
Per/For 810/B/20
X 110 mm
Y 730 mm



1819/5
Per/For 810/B/19
Per/For 810/B/20
X 110 mm
Y 730 mm

LAMINATO A CALDO
HOT ROLLED



Art. 812/9
Per/For 811/I
X 110 mm
Y 150 mm
forgiata
Hor forged



Art. 812/10
Per/For 811/I
X 110 mm
Y 300 mm
forgiata
Hor forged



Art. 812/11
Per/For 811/I
X 110 mm
Y 730 mm
forgiata
Hor forged



Art. 811/I
Ø 56 x 17 mm
L 2500 mm



Art. 1822/16
Per/For 811/I

Ø esterno
External Dia.
325 mm



Ø esterno
External Dia.
325 mm

Art. 1822/9
Per/For 811/I



ARTEFERRO

LAMINATO A FREDDO
COLD ROLLED



Dimensioni Dimensions	L 3000 mm	L 6000 mm
	Cod.art./Art.no.	Cod.art./Art.no.
20 x 8 mm	118/7	118/7/6000
25 x 6 mm	1838/5	1838/5/6000
25 x 8 mm	118/8	118/8/6000
25 x 10 mm	1838/6	1838/6/6000
30 x 6 mm	1838/7	1838/7/6000
30 x 8 mm	114/9	114/9/6000
40 x 8 mm	1838/2	1838/2/6000
50 x 8 mm	1838/3	1838/3/6000
60 x 8 mm	1838/4	1838/4/6000
30 x 8 mm	186/4 zincato-galvanized	

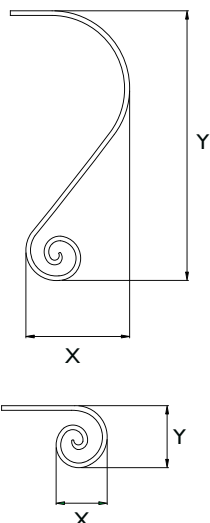

X 130 mm
Y 110 mm

X 110 mm
Y 300 mm

X 110 mm
Y 730 mm

Ø esterno
External Dia.
325 mm

Ø esterno
External Dia.
325 mm

	Cod.art./Art.no.	Cod.art./Art.no.	Cod.art./Art.no.	Cod.art./Art.no.	Cod.art./Art.no.
per/For 30 x 8 mm	1818/11	1818/7	1818/1	1825/1	1825/5
per/For 40 x 8 mm	1818/12	1818/8	1818/2	1825/2	1825/6
per/For 50 x 8 mm	1818/13	1818/9	1818/3	1825/3	1825/7
per/For 60 x 8 mm	1818/14	1818/10	1818/4	1825/4	1825/8



LAMINATO A FREDDO
COLD ROLLED

Dimensioni Dimensions	L 3000 mm	L 6000 mm
	Cod.art./Art.no.	Cod.art./Art.no.
☒ 40 x 8 mm	114/10	114/10/6000



Art. 116/6
Per/For 114/10
X 110 mm
Y 300 mm

Art. 116/14
Per/For 114/10
X 130 mm
Y 110 mm

Art. 116/22
Per/For 114/10
X 110 mm
Y 300 mm

Art. 114/B/9
Per/For Art.114/10
X 110 mm
Y 730 mm

curva a 90°/flat bend
Art. 116/30
Per/For Art.114/10

curva a 180°/flat bend
Art. 116/A/13
Per/For Art.114/10

Art. 1378/6
Per/For Art.114/10
H 230 mm
L 300 mm

Art. 1378/15
Per/For Art.114/10
H 320 mm
L 170 mm

LAMINATO A FREDDO
COLD ROLLED

Dimensioni Dimensions	L 3000 mm	L 6000 mm
	Cod.art./Art.no.	Cod.art./Art.no.
☒ 40 x 6 mm	114/14	114/14/6000
☒ 40 x 8 mm	114/5	114/5/6000
☒ 50 x 8 mm	114/13	114/13/6000



Art. 116/2
Per/For Art.114/5
X 110 mm
Y 300 mm

Art. 116/10
Per/For Art.114/5
X 130 mm
Y 110 mm

Art. 116/18
Per/For Art.114/5
X 110 mm
Y 300 mm

Art. 114/B/5
Per/For Art.114/5
X 110 mm
Y 730 mm

curva a 90°/flat bend
Art. 116/26
Per/For Art.114/5

curva a 180°/flat bend
Art. 116/A/9
Per/For Art.114/5

Art. 1378/2
Per/For Art.114/5
H 230 mm
L 300 mm

Art. 1378/11
Per/For Art.114/5
H 320 mm
L 170 mm

LAMINATI A FREDDO - COLD ROLLED



Art. 1378/9
Per/For Art. 118/14
H 230 mm
L 300 mm



Art. 116/38
Per/For Art. 118/14
X 110 mm
Y 300 mm



Art. 116/37
Per/For Art. 118/14
H 130 mm
Y 110 mm



Art. 116/36
Per/For Art. 118/14
X 110 mm
Y 300 mm



Art. 114/B/12
Per/For Art. 118/14
X 110 mm
Y 730 mm

Dimensioni Dimensions	L 3000 mm
	Cod.art./Art.no.
30 x 8 mm	118/13
40 x 8 mm	118/14



Art. 1378/18
Per/For Art. 118/14
H 320 mm
L 170 mm



curva a 180°/flat bend
Art. 116/A/16
Per/For Art. 118/14



curva a 90°/flat bend
Art. 116/39
Per/For Art. 118/14

Dimensioni Dimensions	L 6000 mm
	Cod.art./Art.no.
30 x 8 mm	118/13/6000
40 x 8 mm	118/14/6000



Art. 1378/7
Per/For Art. 114/11
H 230 mm
L 300 mm



Art. 116/23
Per/For Art. 114/11
X 110 mm
Y 300 mm



Art. 116/15
Per/For Art. 114/11
H 130 mm
Y 110 mm



Art. 116/7
Per/For Art. 114/11
X 110 mm
Y 300 mm



114/B/10
Per/For Art. 114/11
X 110 mm
Y 730 mm

Dimensioni Dimensions	40 x 8 mm
	Cod.art./Art.no.
L 3000 mm	114/11
L 6000 mm	114/11/6000



1378/16
Per/For Art. 114/11
H 320 mm
L 170 mm



curva a 180°/flat bend
116/A/14
Per/For Art. 114/11



curva a 90°/flat bend
116/31
Per/For Art. 114/11



Art. 1378/8
Per/For Art. 114/12
H 230 mm
L 300 mm



Art. 116/24
Per/For Art. 114/12
X 110 mm
Y 300 mm



Art. 116/16
Per/For Art. 114/12
H 130 mm
Y 110 mm



Art. 116/8
Per/For Art. 114/12
X 110 mm
Y 300 mm



Art. 114/B/11
Per/For Art. 114/12
X 110 mm
Y 730 mm

Dimensioni Dimensions	40 x 8 mm
	Cod.art./Art.no.
L 3000 mm	114/12
L 6000 mm	114/12/6000



Art. 1378/17
Per/For Art. 114/12
H 320 mm
L 170 mm



curva a 180°/flat bend
Art. 116/A/15
Per/For Art. 114/12



curva a 90°/flat bend
Art. 116/32
Per/For Art. 114/12

LAMINATI A FREDDO - COLD ROLLED



Art. 114/B/8
Per/For Art. 114/8
X 110 mm
Y 730 mm

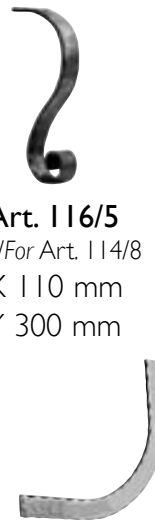

Art. 116/5
Per/For Art. 114/8
X 110 mm
Y 300 mm

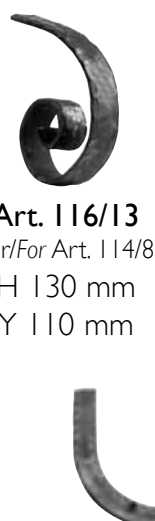

Art. 116/13
Per/For Art. 114/8
H 130 mm
Y 110 mm

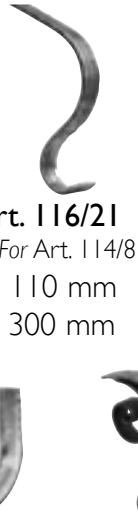

Art. 116/21
Per/For Art. 114/8
X 110 mm
Y 300 mm

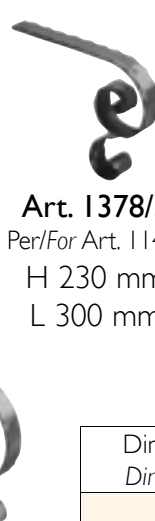

Art. 1378/5
Per/For Art. 114/8
H 230 mm
L 300 mm



Art. 116/29
Per/For Art. 114/8
curva a 90°/flat bend



Art. 116/A/12
Per/For Art. 114/8
curva a 180°/flat bend



Art. 1378/14
Per/For Art. 114/8
H 320 mm
L 170 mm

Dimensioni Dimensions	40 x 8 mm
	Cod.art./Art.no.
L 3000 mm	114/8
L 3000 mm	186/3 zincato/galvanized
L 6000 mm	114/8/6000



Art. 114/B/6
Per/For Art. 114/6
X 110 mm
Y 730 mm

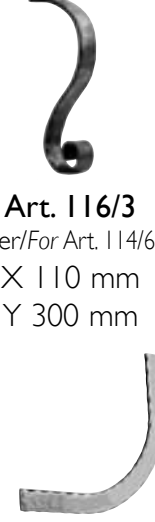

Art. 116/3
Per/For Art. 114/6
X 110 mm
Y 300 mm

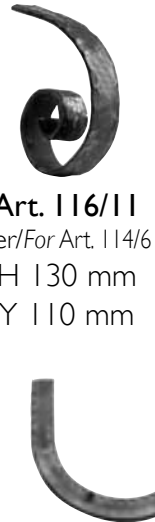

Art. 116/11
Per/For Art. 114/6
H 130 mm
Y 110 mm

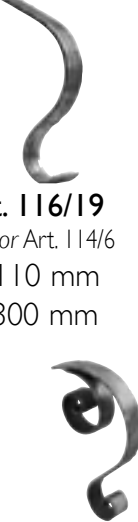

Art. 116/19
Per/For Art. 114/6
X 110 mm
Y 300 mm

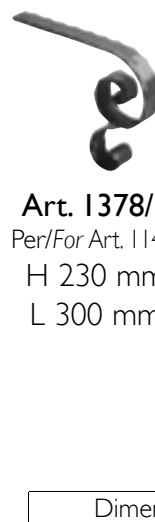

Art. 1378/3
Per/For Art. 114/6
H 230 mm
L 300 mm

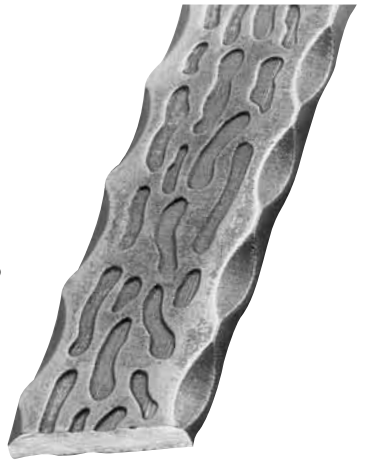

Art. 116/27
Per/For Art. 114/6
curva a 90°/flat bend



Art. 116/A/10
Per/For Art. 114/6
curva a 180°/flat bend



Art. 1378/12
Per/For Art. 114/6
H 320 mm
L 170 mm

Dimensioni Dimensions	40 x 8 mm
	Cod.art./Art.no.
L 3000 mm	114/6
L 6000 mm	114/6/6000



Art. 114/B/7
Per/For Art. 114/7
X 110 mm
Y 730 mm

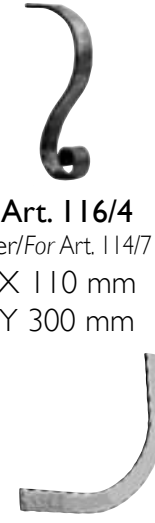

Art. 116/4
Per/For Art. 114/7
X 110 mm
Y 300 mm

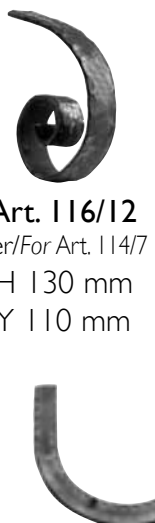

Art. 116/12
Per/For Art. 114/7
H 130 mm
Y 110 mm

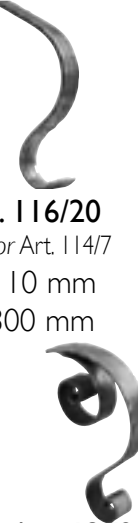

Art. 116/20
Per/For Art. 114/7
X 110 mm
Y 300 mm

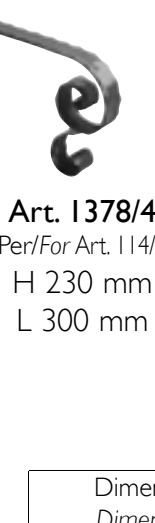

Art. 1378/4
Per/For Art. 114/7
H 230 mm
L 300 mm



Art. 116/28
Per/For Art. 114/7
curva a 90°/flat bend



Art. 116/A/11
Per/For Art. 114/7
curva a 180°/flat bend



Art. 1378/13
Per/For Art. 114/7
H 320 mm
L 170 mm

Dimensioni Dimensions	40 x 8 mm
	Cod.art./Art.no.
L 3000 mm	114/7
L 6000 mm	114/7/6000

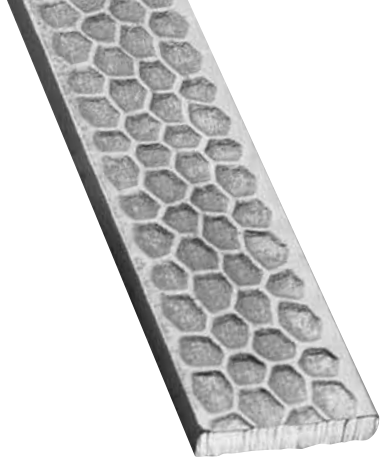

**LAMINATO A FREDDO
COLD ROLLED**

Dimensioni Dimensions	40 x 8 mm
	Cod.art./Art.no.
L 3000 mm	114/4
L 6000 mm	114/4/6000



Art. 1378/1
Per/For Art. 114/4
H 230 mm
L 300 mm



Art. 116/17
Per/For Art. 114/4
X 110 mm
Y 300 mm



Art. 116/9
Per/For Art. 114/4
H 130 mm
Y 110 mm



Art. 116/1
Per/For Art. 114/4
X 110 mm
Y 300 mm



Art. 114/B/4
Per/For Art. 114/4
X 110 mm
Y 730 mm



Art. 1378/10
Per/For Art. 114/4
H 320 mm
L 170 mm



curva a 180°/flat bend
Art. 116/A/8
Per/For Art. 114/4



curva a 90°/flat bend
Art. 116/25
Per/For Art. 114/4

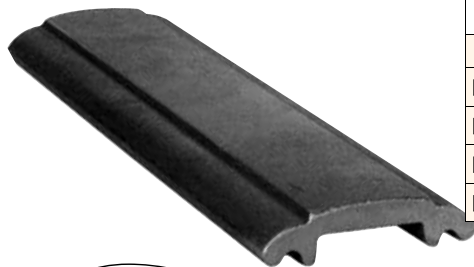

**LAMINATO A CALDO
HOT ROLLED**

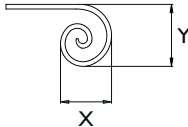
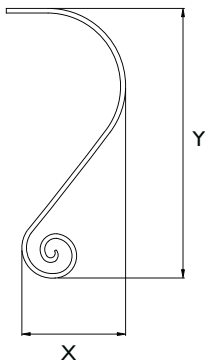
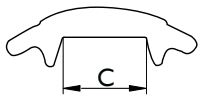

Dimensioni Dimensions	C	L 3000 mm	L 6000 mm
		Cod.art./Art.no.	Cod.art./Art.no.
35 x 10 mm	16 mm	810/B/1	810/B/5
40 x 10,5 mm	18 mm	810/B/2	810/B/6
45 x 16 mm	22 mm	810/B/3	810/B/7
55 x 17 mm	24,8 mm	810/B/4	810/B/8



Dimensioni Dimensions	Cod.art./Art.no.	Cod.art./Art.no.	Cod.art./Art.no.
per/For 35 x 10 mm	1377/1	1377/14	1819/1
per/For 40 x 10,5 mm	1377/2	1377/15	1819/2
per/For 45 x 16 mm	1377/3	1377/16	1819/3
per/For 55 x 17 mm	1377/4	1377/17	1819/4

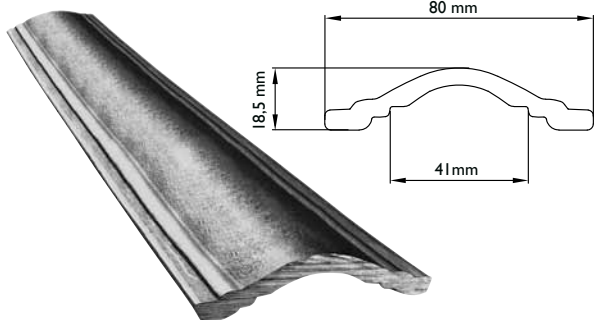

Dimensioni Dimensions	L 3000 mm	L 6000 mm
	Cod.art./Art.no.	Cod.art./Art.no.
80 x 18,5 mm	811/9/T	811/10/T

**LAMINATO A FREDDO
COLD ROLLED**



Art. 1820/14
Per/For Art. 810/B/9/T
Per/For Art. 810/B/10/T
X 130 mm
Y 110 mm



Art. 1820/13
Per/For Art. 810/B/9/T
Per/For Art. 810/B/10/T
X 110 mm
Y 300 mm



Art. 1820/12
Per/For Art. 810/B/9/T
Per/For Art. 810/B/10/T
X 110 mm
Y 730 mm

Dimensioni Dimensions	L 3000 mm	L 6000 mm
	Cod.art./Art.no.	Cod.art./Art.no.
☒ 41 x 11 mm	811/4/T	811/7/T

LAMINATO A FREDDO
COLD ROLLED

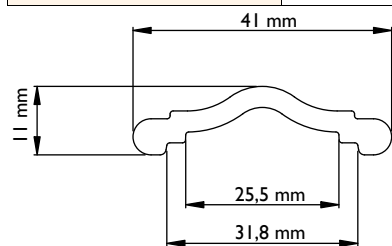

Art. 812/13/T
Per/For Art. 810/B/4
Per/For Art. 810/B/7
X 130 mm
Y 110 mm



Art. 1377/41/T
Per/For Art. 810/B/4
Per/For Art. 810/B/7
X 110 mm
Y 300 mm



Art. 1820/10
Per/For Art. 810/B/4
Per/For Art. 810/B/7
X 110 mm
Y 730 mm



Ø esterno
External Dia.
205 mm
Art. 1825/27
Per/For Art. 810/B/4
Per/For Art. 810/B/7



Ø esterno
External Dia.
205 mm
Art. 1825/17
Per/For Art. 810/B/4
Per/For Art. 810/B/7



Art. 1822/9
Per/For Art. 114/1
Ø est. 325 mm



Art. 115/5
Per/For Art. 114/1
X 160 mm
Y 730 mm



Art. 115/1
Per/For Art. 114/1
X 300 mm
Y 100 mm



Art. 115/4
Per/For Art. 114/1
X 150 mm
Y 130 mm



Art. 114/1
☒ 58 x 14 mm
L 2000 mm

CORRIMANI FUCINATI
A MANO
HAND FORGED
HANDRAILS



Art. 1822/20
per/for 114/1
Ø est. 325 mm



Art. 1814/1
Per/For Art. 1838/1
X 160 mm
Y 730 mm



Art. 1814/7
Per/For Art. 1838/1
X 300 mm
Y 100 mm



Art. 1814/13
Per/For Art. 1838/1
X 150 mm
Y 130 mm

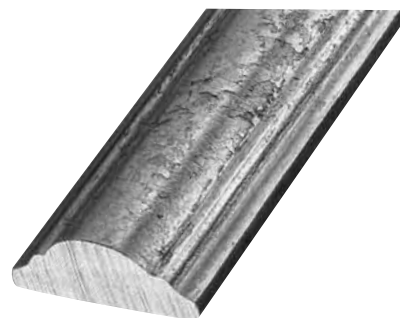

Art. 1838/1
☒ 46 x 18 mm
L 2000 mm



Art. 1822/11
Per/For 1838/1
Ø est. 325 mm



Art. 1822/22
Per/For 1838/1
Ø est. 325 mm



Art. 1838/8
 \varnothing 30 x 5 mm
 L 3000 mm



LAMINATI A FREDDO
 COLD ROLLED

Art. 1839/25
 \varnothing 16 x 3 mm
 L 4000 mm



ARTEFERRO

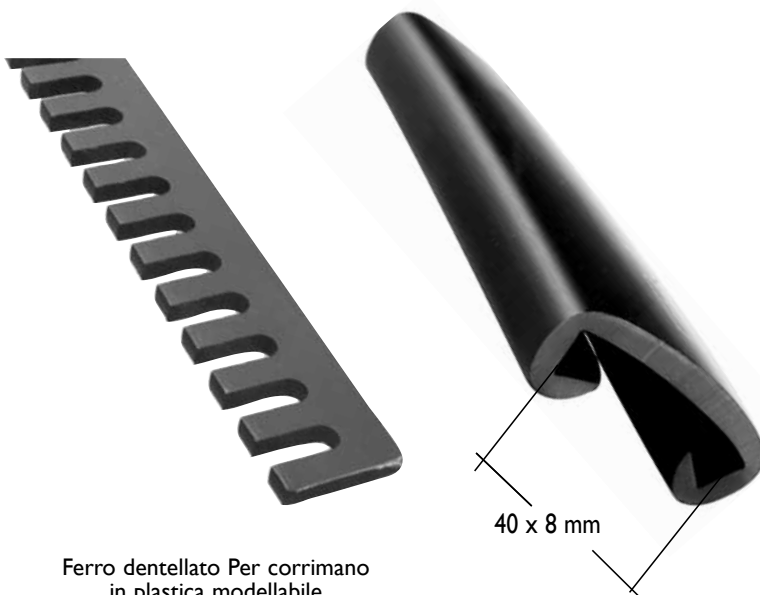

Ferro dentellato Per corrimano
 in plastica modellabile
 Slotted steel section for smooth
 black plastic moulding

Art. 118/F/10
 \varnothing 40 x 8 mm
 L 1500 mm

Plastica modellabile
 Smooth black plastic moulding
 - Rotoli da 25 mt / 25 m Rolls -

Art. 118/F/9
 per/for \varnothing 40 x 8 mm

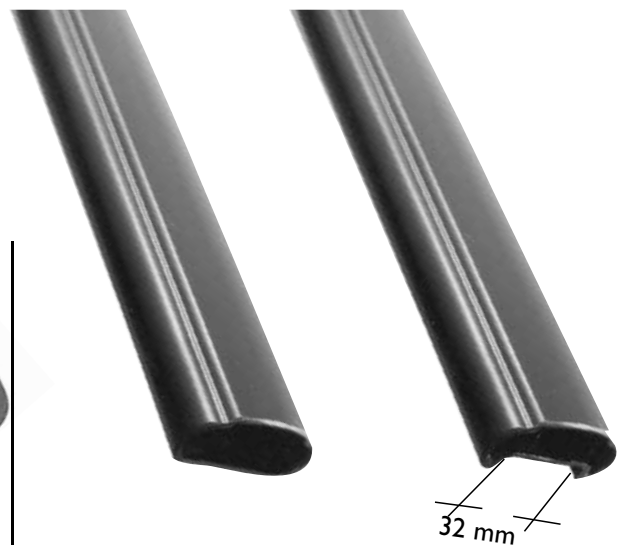

tubolare d'acciaio
 steel tubular

Art. 118/F/7
 \varnothing 50 x 30 mm
 L 6000 mm

tubolare d'acciaio
 steel tubular

Art. 118/F/8
 \varnothing 50 x 25 mm
 L 6000 mm

PROFILI LAMINATI A FREDDO
COLD ROLLED PROFILES

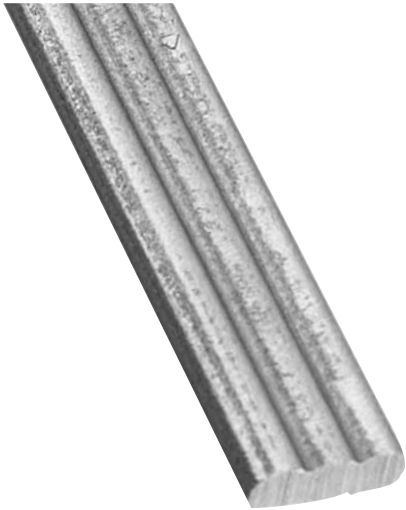

Art. 114/A/6
 \square 17 x 5 mm
 L 3000 mm



Art. 1837/7
 \square 52 x 7 mm
 L 3000 mm



Art. 114/A/5
 \square 30 x 5 mm
 L 3000 mm



Art. 810/A/19/T
 \square 25 x 40 mm
 L 3000 mm

Art. 810/A/20/T
 \square 25 x 40 mm
 L 6000 mm



Art. 1373/I
 30 x 30 x 4 mm
 L 3000 mm



Art. 1837/8
 \square 57 x 17 mm
 L 3000 mm

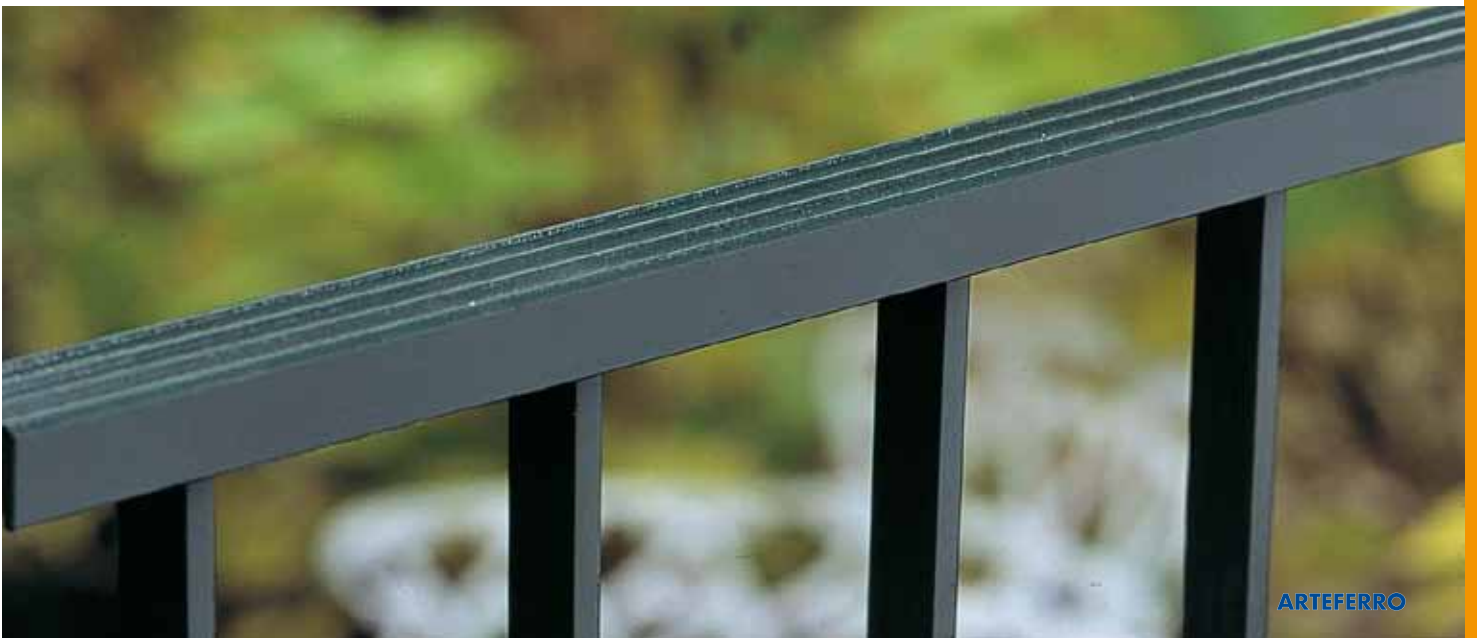

CORRIMANO e BARRE LUNGHE - HANDRAIL and LONG BARS

ARTEFERRO



Art. 158/3
 □ 14 x 4 mm
 L 4000 mm



ARTEFERRO

	per 2 barre/bars 8 x 8 mm - 158/20	
H 8 mm	per 4 barre/bars 8 x 8 mm - 158/21	
	per 3 barre/bars 8 x 8 mm - 158/22	
	per 2 barre/bars 10 x 5 mm - 158/23	
H 10 mm	per 3 barre/bars 10 x 10 mm - 158/24	
	per 2 barre/bars 10 x 10 mm - 158/25	
	per 8 x 8 mm + 2 barre/bars 10 x 5 mm - 1848/2	
	per 3 barre/bars 10 x 5 mm - 1848/6	
	per 2 barre/bars 12 x 6 mm - 158/26	
	per 3 barre/bars 12 x 6 mm - 158/27	
H 12 mm	per 4 barre/bars 12 x 6 mm - 158/28	
	per 6 barre/bars 12 x 6 mm - 158/29	
	per 2 barre/bars 12 x 12 mm - 158/30	
	per tondo/rond 16 mm + 2 barre/bars 12 x 6 mm - 1848/3	
	per 5 barre/bars 12 x 6 mm - 1848/4	
H 16 mm	per 16 x 16 mm + 2 barre/bars 16 x 8 mm - 1848/1	
H 20 mm	per 2 barre/bars 20 x 6 mm - 1848/5	

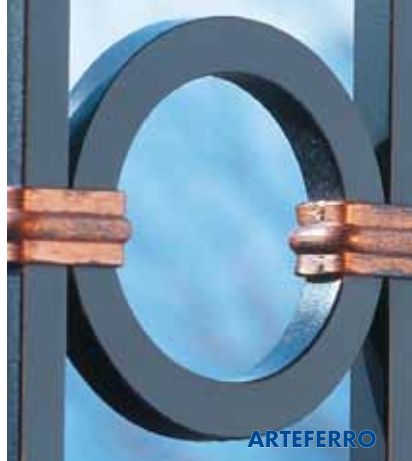

ARTEFERRO



Art. 158/4
 ∅ 18 x 5 mm
 L 4000 mm

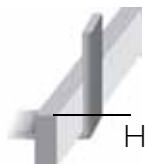
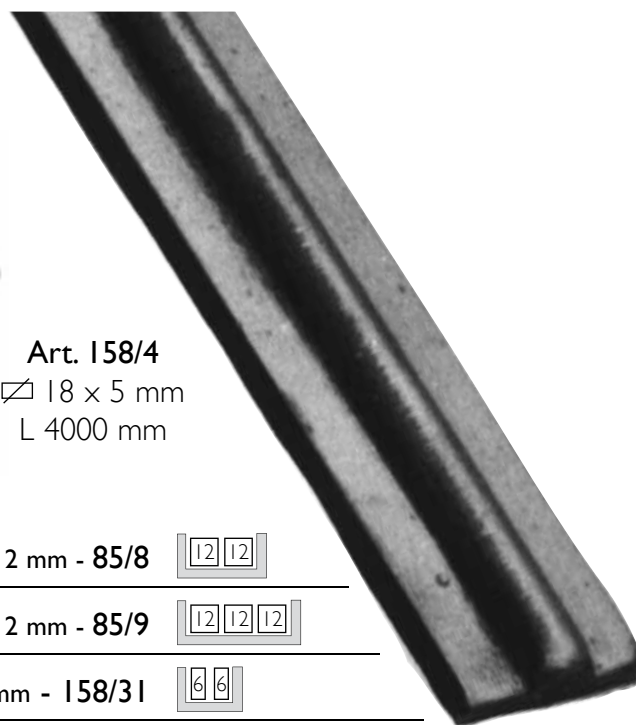

H
12 mm

per 2 barre/bars 12 x 12 mm - 85/8

per 3 barre/bars 12 x 12 mm - 85/9

per 2 barre/bars 12 x 6 mm - 158/31

per 4 barre/bars 12 x 12 mm - 158/32

per 5 barre/bars 12 x 6 mm - 158/33

per 12 x 12 mm + 4 barre/bars 12 x 6 mm - 1848/11

per 2 barre/bars 12 x 12 mm + 3 barre/bars 12 x 6 mm - 1848/12

per 14 x 14 mm + 2 barre/bars 14 x 8 mm - 181/7

per 14 x 14 mm + 1 barra/bar 14 x 8 mm - 181/8

per 2 barre/bars 14 x 8 mm - 1848/7

per 3 barre/bars 14 x 8 mm - 1848/8

per 14 x 14 mm + 4 barre/bars 12 x 6 mm - 1848/13

per 3 barre/bars 14 x 14 mm - 1848/15

per 2 barre/bars 14 x 14 mm + 2 barre/bars 12 x 6 mm - 1848/16

per 14 x 14 mm + 2 barre/bars 14 x 6 mm - 1848/14

per 14 x 14 mm + 1 barra/bar 16 x 6 mm - 1848/20

per 14 x 14 mm + 4 barre/bars 16 x 6 mm - 1848/21

H
16 mm

per 4 barre/bars 16 x 6 mm - 1848/9

per 16 x 16 mm + 2 barre/bars 16 x 6 mm - 1848/17

H
25 mm

per 1 barra/bar 25 x 25 mm - 1848/18

H
30 mm

per 1 barra/bar 30 x 30 mm - 1848/19

per 2 barre/bars 30 x 4 mm - 1848/10



Art. 158/1

▧ 14 x 4 mm
L 4000 mm

Dimensioni Dimensions	L 3000 mm	L 4000 mm	L 6000 mm
	Cod.art./Art.no.	Cod.art./Art.no.	Cod.art./Art.no.
▧ 14 x 4 mm	-	158/1	-
▧ 18 x 5 mm	-	158/2	-
▧ 25 x 8 mm	158/49		158/52
▧ 30 x 8 mm	158/50		158/53
▧ 40 x 8 mm	158/51		158/54



H

H
12 mm

per 4 barre/bars 6 x 6 mm - **158/13**

per 2 barre/bars 12 x 6 mm - **158/14**

per 3 barre/bars 12 x 6 mm - **158/15**

per 4 barre/bars 12 x 6 mm - **158/16**

per 6 barre/bars 12 x 6 mm - **158/17**

per 5 barre/bars 12 x 6 mm - **1851/1**

per 2 barre/bars dia 12 mm - **1851/2**

per 3 barre/bars dia 12 mm - **1851/3**

per 14 x 14 mm + 2 barre/bars 12 x 6 mm - **1851/5**

per 14 x 14 mm + 4 barre/bars 12 x 6 mm **1851/6**

H
14 mm

per 1 barra/bar 14 x 14 mm - **1851/4**

per 16 x 16 mm + 2 barre/bars 16 x 6 mm - **1851/7**

per 16 x 16 mm + 4 barre/bars 16 x 6 mm - **1851/8**

per 16 x 16 mm + 2 barre/bars 16 x 4 mm - **1851/9**

H
16 mm

per 16 x 16 mm + 4 barre/bars 16 x 4 mm - **1851/10**

per 2 barre/bars 16 x 8 mm - **1851/11**

per 3 barre/bars 16 x 8 mm - **1851/12**

per 1 barra/bar 16 x 16 mm - **1851/13**

▧ 18 x 5 mm = Art. 158/2

per 4 barre/bars 10 x 10 mm - **158/18**

H
18 mm

per 1 barra/bar 10 x 10 mm - **158/19**

H
25 mm

per 2 barr2/bars 25 x 12 mm - **1851/26**

per 2 barre/bars 12 x 12 mm - **1851/27**

per 3 barre/bars 16 x 16 mm - **1851/28**

per 1 barra/bar 25 x 25 mm - **1851/29**

per 1 barra/bars 30 x 30 mm - **1851/30**



Dimensioni Dimensions	L 4000 mm
	Cod.art./Art.no.
∅ 11 x 3 mm	158/5
∅ 14 x 4 mm	158/6
∅ 16 x 5 mm	158/7
∅ 21 x 6 mm	158/8

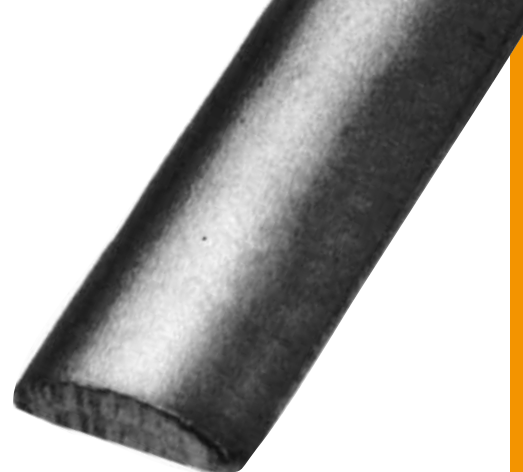

H 10 mm	∅ 11 x 3 mm = Art. 158/5	
	per 2 barre/bars 10 x 5 mm - 158/34	
H 10 mm	per 3 barre/bars 10 x 5 mm - 158/35	
	∅ 14 x 4 mm = Art. 158/5	
H 10 mm	per 3 barre/bars dia 10 mm - 1846/3	
	per 2 barre/bars dia 10 mm - 1846/4	
H 12 mm	per 4 barre/bars 12 x 6 mm - 1851/14	
	per 3 barre/bars dia 12 mm - 1851/15	
	per 2 barre/bars dia 12 mm - 1851/16	
	per 3 barre/bars 12 x 12 mm - 1851/19	
	per 12 x 12 mm + 2 barre/bars 12 x 6 mm - 1851/20	
	per 14 x 14 mm + 2 barre/bars 12 x 6 mm - 1851/21	
H 14 mm	per 2 barre/bars dia 14 mm - 1851/17	
	per 3 barre/bars dia 14 mm - 1851/18	
H 16 mm	per 2 barre/bars 16 x 4 mm - 158/36	
	per 3 barre/bars 16 x 4 mm - 158/37	
	per 1 barra/bar 16 x 16 mm - 1851/22	
	per 16 x 16 mm + 1 barra/bar 16 x 6 mm - 1851/23	
	per 4 barre/bars 16 x 4 mm - 1851/24	
H 20 mm	per 5 barre/bars 16 x 4 mm - 1851/25	
	per 2 barre/bars 20 x 4 mm - 158/38	
	per 3 barre/bars 20 x 4 mm - 158/39	
	per 2 barre/bars 20 x 6 mm - 158/40	
	per 3 barre/bars 20 x 6 mm - 158/41	
H 25 mm	per 2 barre/bars 25 x 4 mm - 158/42	
	per 3 barre/bars 25 x 4 mm - 158/43	
	per 2 barre/bars 25 x 6 mm - 158/44	



Dimensioni Dimensions	L 3000 mm	L 6000 mm
	Cod.art./Art.no.	Cod.art./Art.no.
Φ 12 x 12 mm	118/1	118/1/6000
Φ 14 x 14 mm	118/2	118/2/6000
Φ 16 x 16 mm	118/3	118/3/6000
Φ 18 x 18 mm	118/4	118/4/6000
Φ 20 x 20 mm	118/5	118/5/6000
Φ 25 x 25 mm	118/6	118/6/6000
Φ 30 x 30 mm	118/24	118/24/6000
Φ 40 x 40 mm	118/25	118/25/6000

Zincato/Galvanized

Φ 14 x 14 mm	186/5	-
Φ 12 x 12 mm	186/6	-



Dimensioni Dimensions	L 3000 mm	L 6000 mm
	Cod.art./Art.no.	Cod.art./Art.no.
∠ 20 x 8 mm	118/7	118/7/6000
∠ 25 x 6 mm	1838/5	1838/5/6000
∠ 25 x 8 mm	118/8	118/8/6000
∠ 25 x 10 mm	1838/6	1838/6/6000
∠ 30 x 6 mm	1838/7	1838/7/6000
∠ 30 x 8 mm	114/9	114/9/6000
∠ 40 x 8 mm	1838/2	1838/2/6000
∠ 50 x 8 mm	1838/3	1838/3/6000
∠ 60 x 8 mm	1838/4	1838/4/6000

Zincato/Galvanized

∠ 40 x 8 mm	186/3	-
∠ 30 x 8 mm	186/4	-



Dimensioni Dimensions	L 3000 mm	L 6000 mm
	Cod.art./Art.no.	Cod.art./Art.no.
∠ 12 x 6 mm	1839/21	1839/21/6000
∠ 14 x 6 mm	1839/22	1839/22/6000
∠ 14 x 8 mm	1839/23	1839/23/6000
∠ 16 x 8 mm	1839/24	1839/24/6000
∠ 25 x 6 mm	1839/15	1839/15/6000
∠ 25 x 8 mm	1839/16	1839/16/6000
∠ 30 x 6 mm	1839/17	1839/17/6000
∠ 30 x 8 mm	1839/18	1839/18/6000
∠ 30 x 15 mm	1839/1	1839/1/6000
∠ 30 x 20 mm	1839/2	1839/2/6000
∠ 40 x 6 mm	1839/19	1839/19/6000
∠ 40 x 8 mm	1839/20	1839/20/6000
∠ 40 x 15 mm	1839/3	1839/3/6000
∠ 40 x 20 mm	1839/4	1839/4/6000



Dimensioni Dimensions	spessore thickness	L 3000 mm	L 6000 mm
		Cod.art./Art.no.	Cod.art./Art.no.
Φ 12 x 12 mm	1 mm	I374/21	I374/19
Φ 12 x 12 mm	1,5 mm	I374/26	I374/27
Φ 16 x 16 mm	1 mm	I374/22	I374/20
Φ 16 x 16 mm	1,5 mm	I374/25	I374/24
Φ 20 x 20 mm	2,5 mm	I374/1	I18/E/1
Φ 25 x 25 mm	2,5 mm	I374/2	I18/E/9
Φ 30 x 30 mm	2,5 mm	I374/3	I18/E/3
Φ 35 x 35 mm	2,5 mm	I374/23	I18/E/18
Φ 40 x 40 mm	2,5 mm	I374/4	I18/E/5
Φ 50 x 50 mm	2,5 mm	I374/5	I374/15
Φ 60 x 60 mm	2,5 mm		I18/E/13
Φ 80 x 80 mm	3 mm	I374/6	I374/16
Φ 100 x 100 mm	3 mm	I374/7	I374/17
Φ 120 x 120 mm	3 mm	I374/8	I374/18

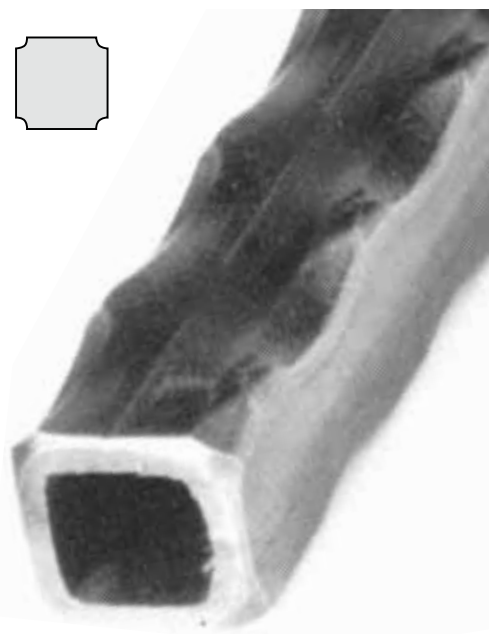

Dimensioni Dimensions	spessore thickness	L 3000 mm	L 6000 mm
		Cod.art./Art.no.	Cod.art./Art.no.
▧ 30 x 20 mm	2,5 mm	I374/9	I18/E/2
▧ 40 x 20 mm	2,5 mm	I374/10	I18/E/4
▧ 40 x 30 mm	2,5 mm	I374/28	I18/E/19
▧ 50 x 30 mm	2,5 mm	I374/11	I18/E/6
▧ 50 x 40 mm	2,7 mm		I18/E/14
▧ 60 x 30 mm	2,7 mm	I374/12	I18/E/7
▧ 60 x 40 mm	2,5 mm	I374/29	I18/E/15
▧ 60 x 40 mm *	2,6 mm		I18/E/16
▧ 80 x 40 mm	2,7 mm	I374/13	I18/E/8
▧ 100 x 40 mm	2,7 mm	I374/14	I18/E/10
▧ 100 x 50 mm	2,7 mm	I374/30	I18/E/17

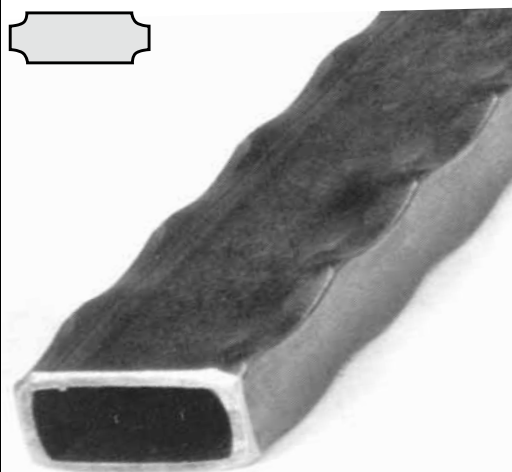
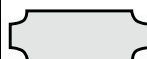

* BATTITURA ALLUNGATA - EXTENDEND HAMMERING



CORRIMANO e BARRE LUNGHE - HANDRAIL and LONG BARS

ARTEFERRO



lavorato su 2 lati
hammered on 2 sides

Art. 1370/5

Ø 12 × 12 mm
L 2000 mm

Art. 1370/6

Ø 14 × 14 mm
L 2000 mm

Art. 1370/7

Ø 16 × 16 mm
L 2000 mm

lavorato su 4 lati
hammered on 4 sides

Art. 1370/8

Ø 25 × 25 mm
L 2000 mm

Art. 1370/9

Ø 30 × 30 mm
L 2000 mm



MAGLIATO MANUALMENTE
per abbinamento ai caposaldi

HAND HAMMERED
to match newel posts

Art. 1370/11

Ø 25 × 25 mm
L 2000 mm

Art. 1370/12

Ø 30 × 30 mm
L 2000 mm



Dimensioni Dimensions	L 2000 mm	L 3000 mm	L 6000 mm
	Cod.art./Art.no.	Cod.art./Art.no.	Cod.art./Art.no.
∅ 12 x 12 mm	118/A/44	GD124/17	GD124/25
∅ 14 x 14 mm	118/A/17	GD124/18	GD124/26
∅ 16 x 16 mm	118/A/18	GD124/19	GD124/27
∅ 18 x 18 mm	118/A/19	GD124/20	GD124/28
∅ 20 x 20 mm	118/A/20	GD124/21	GD124/29
∅ 22 x 22 mm	118/A/21	GD124/22	GD124/30
∅ 25 x 25 mm	118/A/22	GD124/23	GD124/31
∅ 30 x 30 mm	118/A/23	GD124/24	GD124/32

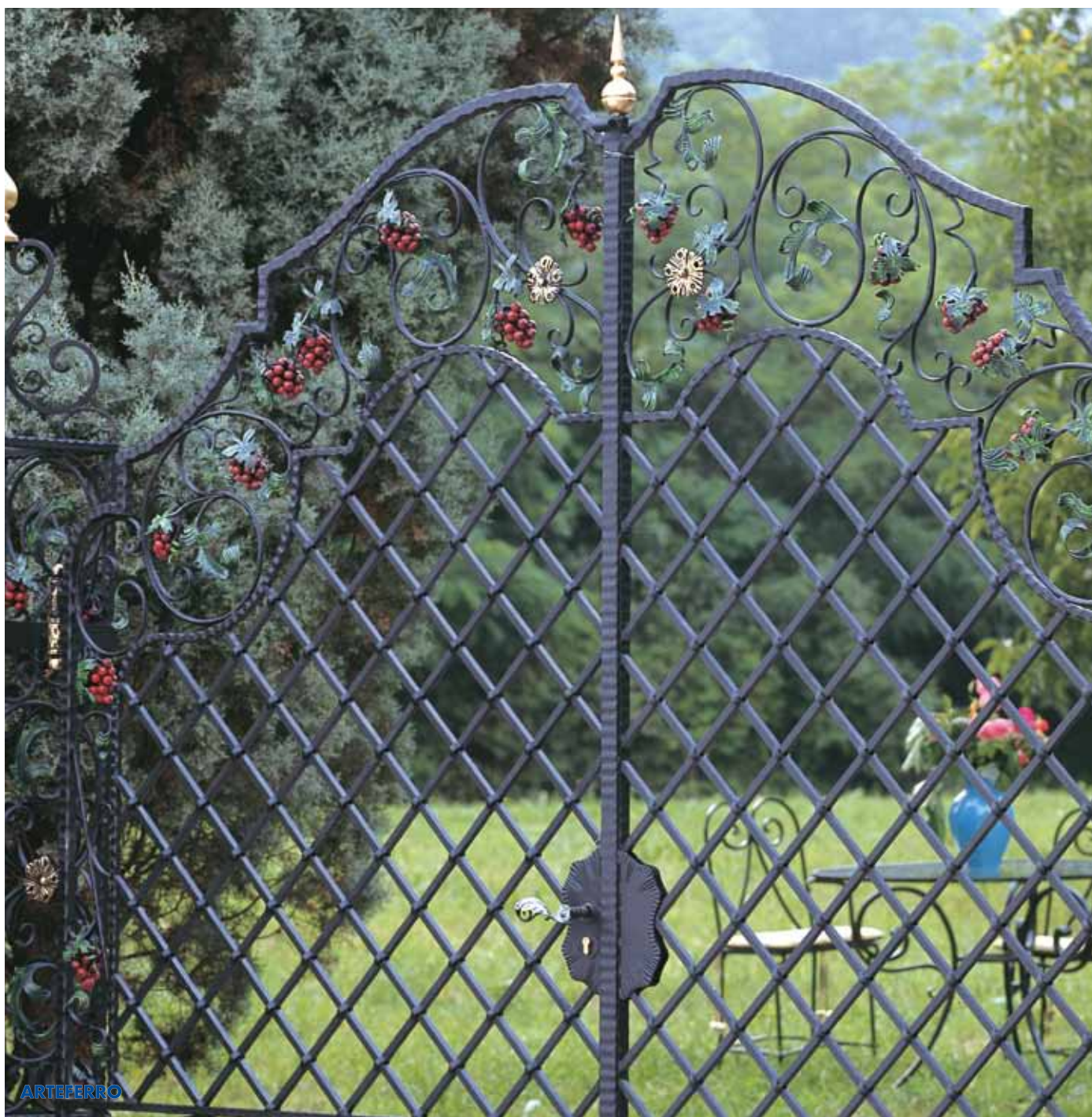
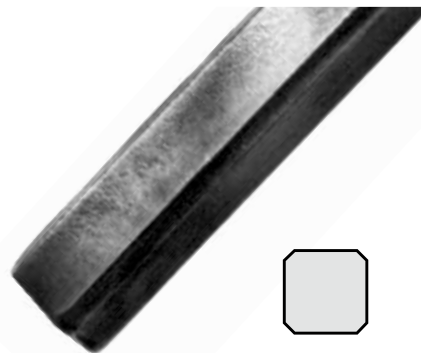

CORRIMANO e BARRE LUNGHE - HANDRAIL and LONG BARS

ARTEFERRO

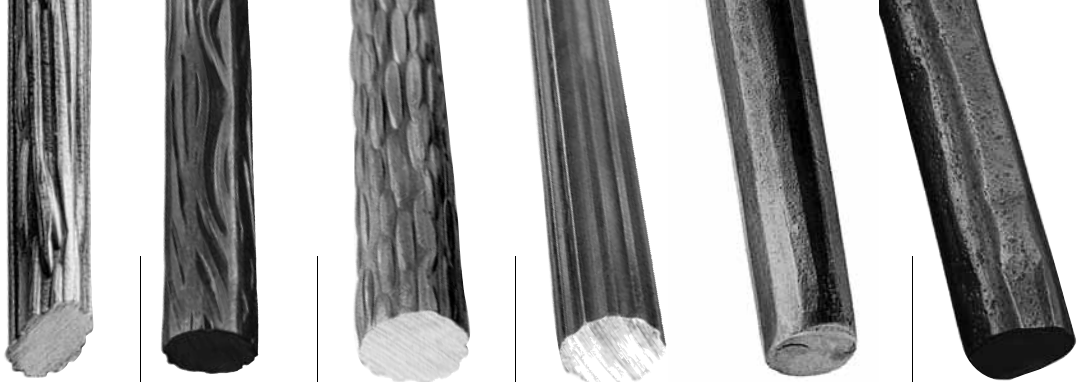

Dimensioni Dimensions						
L 3000 mm	Tralcio di vite Grapevine effect	Corteccia Tree bark effect			Magliato hand forged	
	Cod.art./Art.no.	Cod.art./Art.no.	Cod.art./Art.no.	Cod.art./Art.no.	Cod.art./Art.no.	Cod.art./Art.no.
Ø/dia 6 mm						600/1
Ø/dia 8 mm	598/11	599/1	1841/8	1841/19		600/2
Ø/dia 10 mm	598/12	599/2	1841/9	1841/20		600/3
Ø/dia 12 mm	598/13	599/3	1841/10	1841/21	598/1	600/4
Ø/dia 14 mm	598/14	599/4	1841/11	1841/22	598/2	600/5
Ø/dia 16 mm	598/15	599/5	1841/12	1841/23	598/3	600/6
Ø/dia 18 mm	598/16	599/6	1841/13	1841/24	598/4	600/7
Ø/dia 20 mm	598/17	599/7	1841/14	1841/25	598/5	600/8
Ø/dia 22 mm	598/18	599/8	1841/15	1841/26		600/9
Ø/dia 24 mm	598/19	599/9	1841/16	1841/27		600/10
Ø/dia 25 mm					598/6	
Ø/dia 26 mm			1841/17	1841/28		
Ø/dia 30 mm			1841/18	1841/29	598/7	
Ø/dia 40 mm					598/8	



Magliato manualmente
Hand forged

Art. 598/10

Ø 8 mm
L 3000 mm



L 3000 mm

Dimensioni Dimensions	magliato a mano hand hammered
	Cod.art./Art.no.
Ø/dia 14 mm	118/A/10
Ø/dia 16 mm	118/A/11
Ø/dia 18 mm	118/A/12
Ø/dia 20 mm	118/A/13
Ø/dia 25 mm	118/A/14
Ø/dia 30 mm	118/A/15
Ø/dia 40 mm	118/A/16



Art. 598/9

Ø 8 mm
L 3000 mm





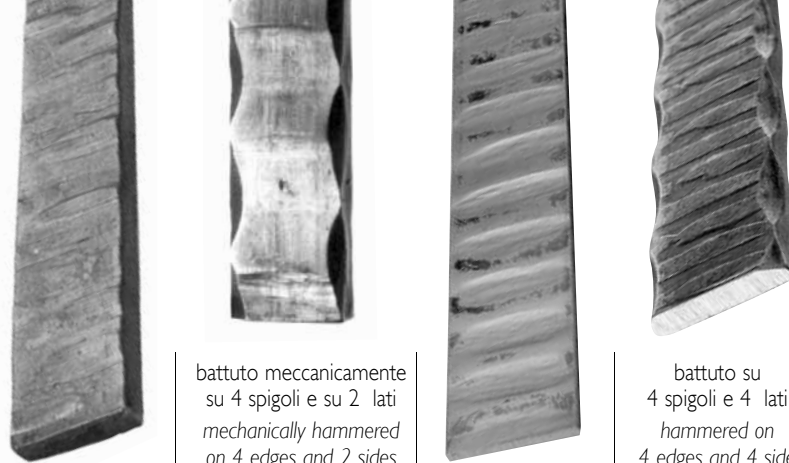

ARTEFERRO



Dimensioni Dimensions		battuto meccanicamente su 4 spigoli e su 2 lati mechanically hammered on 4 edges and 2 sides		battuto su 4 spigoli e 4 lati hammered on 4 edges and 4 sides
L 3000 mm	Cod.art./Art.no.	Cod.art./Art.no.	Cod.art./Art.no.	Cod.art./Art.no.
∅ 16 x 4 mm	118/10			
∅ 20 x 4 mm	118/11			
∅ 20 x 6 mm	118/12			
∅ 20 x 8 mm	118/26			
∅ 25 x 4 mm	118/27			
∅ 25 x 8 mm	118/28			
∅ 30 x 6 mm			1839/7	1839/11
∅ 30 x 8 mm	118/13	118/A/6	1839/8	1839/12
∅ 30 x 10 mm		118/A/7		
∅ 30 x 15 mm		118/A/8		
∅ 30 x 20 mm	180/51	118/A/9		
∅ 40 x 4 mm	118/29			
∅ 40 x 6 mm			1839/9	1839/13
∅ 40 x 8 mm	118/14		1839/10	1839/14
∅ 50 x 4 mm	118/30			



Dimensioni Dimensions		battuto meccanicamente su 4 spigoli e su 2 lati mechanically hammered on 4 edges and 2 sides			
L 3000 mm	Cod.art./Art.no.	Cod.art./Art.no.	Cod.art./Art.no.	Cod.art./Art.no.	
∅ 8 x 8 mm	118/15				
∅ 10 x 10 mm	118/16				
∅ 12 x 12 mm	118/17	118/A/1	1841/1	1841/30	
∅ 14 x 14 mm	118/18	118/A/2	1841/2	1841/31	
∅ 16 x 16 mm	118/19	118/A/3	1841/3	1841/32	
∅ 18 x 18 mm	118/20	118/A/4	1841/4	1841/33	
∅ 20 x 20 mm	118/21	118/A/5	1841/5	1841/34	
∅ 22 x 22 mm			1841/6	1841/35	
∅ 25 x 25 mm	118/22	180/53	1841/7	1841/36	
∅ 30 x 30 mm	118/23	180/50			
∅ 40 x 40 mm		180/54			



L 3000 mm

- Art. 623/1 \square 12 x 6 mm
- Art. 623/2 \square 16 x 6 mm
- Art. 623/3 \square 14 x 6 mm
- Art. 623/12 \square 14 x 8 mm
- Art. 623/13 \square 16 x 8 mm



L 3000 mm

- Art. 623/4 \square 10 x 10 mm
- Art. 623/5 \square 12 x 12 mm
- Art. 623/6 \square 14 x 14 mm
- Art. 623/7 \square 16 x 16 mm
- Art. 623/8 \square 18 x 18 mm
- Art. 623/9 \square 20 x 20 mm
- Art. 623/10 \square 22 x 22 mm
- Art. 623/11 \square 24 x 24 mm

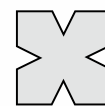

L 3000 mm

- Art. 625/1 \times 8 x 8 mm
- Art. 625/2 \times 10 x 10 mm
- Art. 625/3 \times 12 x 12 mm
- Art. 625/4 \times 14 x 14 mm
- Art. 625/5 \times 16 x 16 mm
- Art. 625/6 \times 18 x 18 mm
- Art. 625/7 \times 20 x 20 mm



L 3000 mm

- Art. 625/8 \square 12 x 12 mm
- Art. 625/9 \square 16 x 16 mm
- Art. 625/10 \square 20 x 20 mm



L 3000 mm

- Art. 626/10 \square 12 mm
- Art. 626/11 \square 14 mm
- Art. 626/12 \square 16 mm
- Art. 626/13 \square 18 mm
- Art. 626/14 \square 20 mm
- Art. 626/15 \square 22 mm
- Art. 626/19 \square 24 mm
- Art. 626/16 \square 26 mm



Rigato su 2 lati
Grooved on 2 sides

L 3000 mm

- 1369/1 \square 14 x 8 mm
- 1369/2 \square 16 x 8 mm



Dimensioni Dimensions	Attorcigliatura sinistra Twisted to the left		Attorcigliatura destra Twisted to the right		Attorcigliatura sinistra Twisted to the left		Attorcigliatura destra Twisted to the right	
	L 3000 mm	L 6000 mm	L 3000 mm	L 6000 mm	L 3000 mm	L 6000 mm	L 3000 mm	L 6000 mm
	Cod.art./Art.no.	Cod.art./Art.no.	Cod.art./Art.no.	Cod.art./Art.no.	Cod.art./Art.no.	Cod.art./Art.no.	Cod.art./Art.no.	Cod.art./Art.no.
∅ 8 × 8 mm	118/H/18	118/H/7						
∅ 10 × 10 mm	118/H/19	118/H/8						
∅ 12 × 12 mm	118/H/20	118/H/9						
∅ 14 × 14 mm	118/H/21	118/H/10						
∅ 16 × 16 mm	118/H/22	118/H/11						
∅ 18 × 18 mm	118/H/23	118/H/12						
∅ 20 × 20 mm	118/H/24	118/H/13						
∅ 25 × 25 mm	118/H/25	118/H/14						
∅ 30 × 30 mm	118/H/26	118/H/15	1806/19	1806/22				
∅ 40 × 40 mm	1806/14	1806/16	1806/18	1806/21				
∅ 50 × 50 mm	1806/13	1806/15	1806/17	1806/20				
∇ 20 × 6 mm					118/H/16	118/H/5		
∇ 30 × 8 mm					118/H/17	118/H/6		
∇ 50 × 25 mm					1806/24	1806/26	1806/28	1806/30
∇ 60 × 30 mm					1806/23	1806/25	1806/27	1806/29

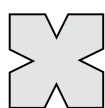

Dimensioni Dimensions	Attorcigliatura sinistra Twisted to the left		Attorcigliatura destra Twisted to the right		Attorcigliatura sinistra Twisted to the left		Attorcigliatura destra Twisted to the right	
	L 3000 mm	L 6000 mm	L 3000 mm	L 6000 mm	L 3000 mm	L 6000 mm	L 3000 mm	L 6000 mm
	Cod.art./Art.no.	Cod.art./Art.no.	Cod.art./Art.no.	Cod.art./Art.no.	Cod.art./Art.no.	Cod.art./Art.no.	Cod.art./Art.no.	Cod.art./Art.no.
∅ 30 × 30 mm	1807/3	1807/6	1807/9	1807/12	1807/15	1807/18	1807/21	1807/24
∅ 40 × 40 mm	1807/2	1807/5	1807/8	1807/11	1807/14	1807/17	1807/20	1807/23
∅ 50 × 50 mm	1807/1	1807/4	1807/7	1807/10	1807/13	1807/16	1807/19	1807/22

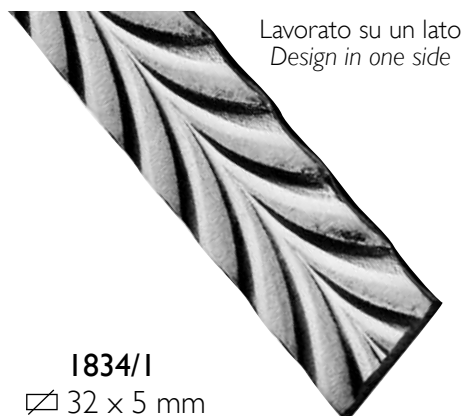

Lavorato su un lato
Design in one side

1834/1
 \varnothing 32 x 5 mm
 L 3000 mm



Lavorato su un lato
Design in one side

1834/2
 \varnothing 31 x 5 mm
 L 3000 mm



Lavorato su un lato
Design in one side

1834/3
 \varnothing 31 x 5 mm
 L 3000 mm



Lavorato su un lato
Design in one side

1834/9
 \varnothing 32 x 6 mm
 L 3000 mm



Lavorato su un lato
Design in one side

1834/5
 \varnothing 32 x 7 mm
 L 3000 mm



Lavorato su un lato
Design in one side

1834/6
 \varnothing 31 x 5 mm
 L 3000 mm

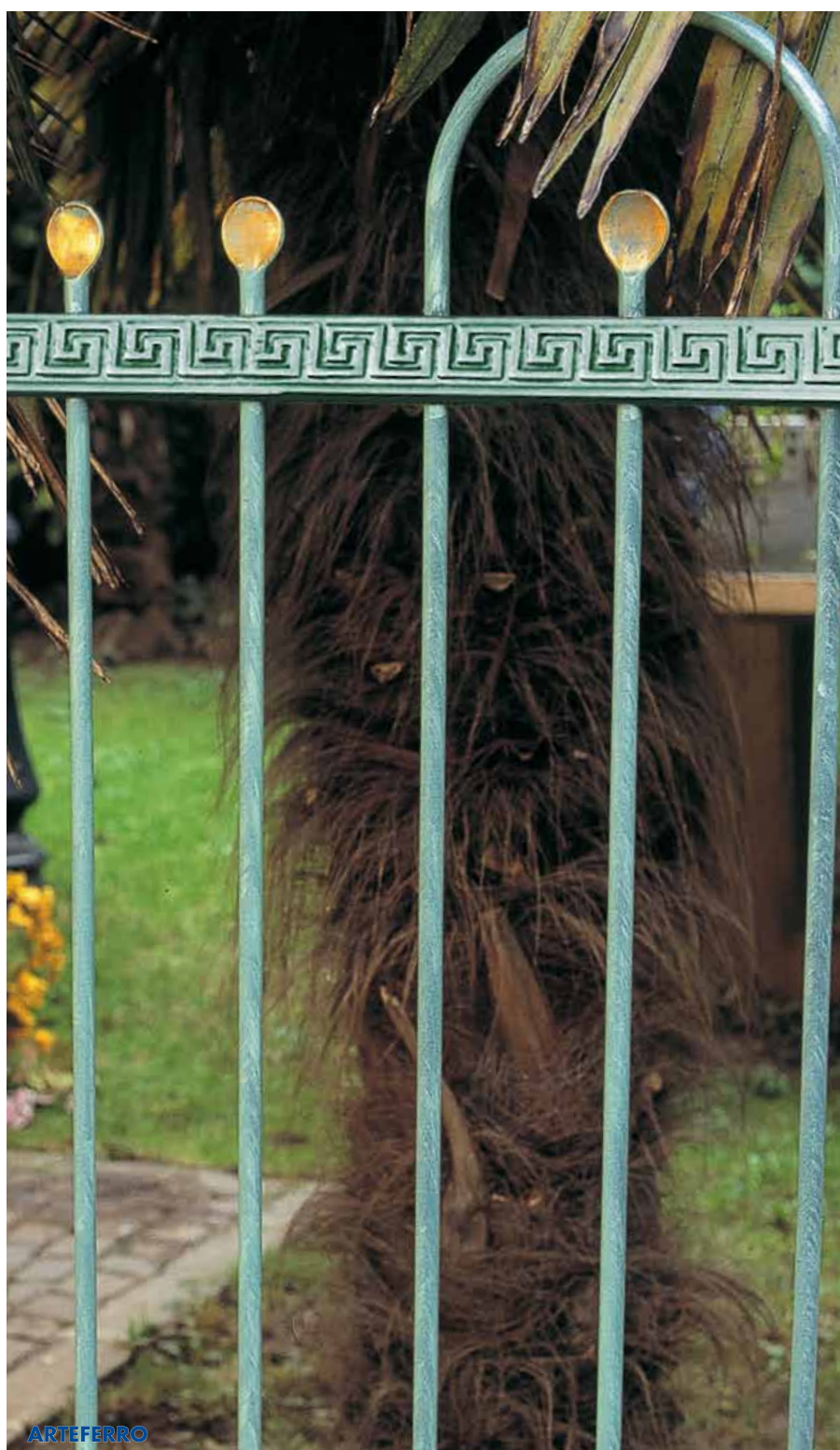

ARTEFERRO

Lavorato su un lato
Design in one side



1834/7
∅ 32 x 6 mm
L 3000 mm

Lavorato su un lato
Design in one side

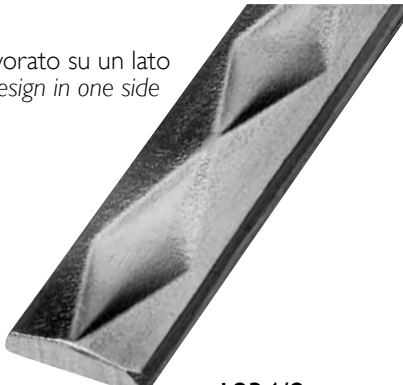

1834/8
∅ 32 x 9 mm
L 3000 mm

Lavorato su un lato
Design in one side

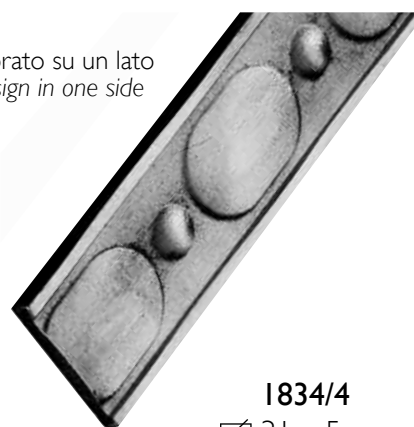

1834/4
∅ 31 x 5 mm
L 3000 mm



L 3000 mm
1837/1 ∅ 23 x 4 mm
1837/2 ∅ 27 x 5 mm
1837/3 ∅ 37 x 7 mm
1837/4 ∅ 41 x 8 mm



L 3000 mm
1837/5 ∅ 20 x 4 mm
1837/6 ∅ 30 x 6 mm



CORRIMANO e BARRE LUNGHE - HANDRAIL and LONG BARS

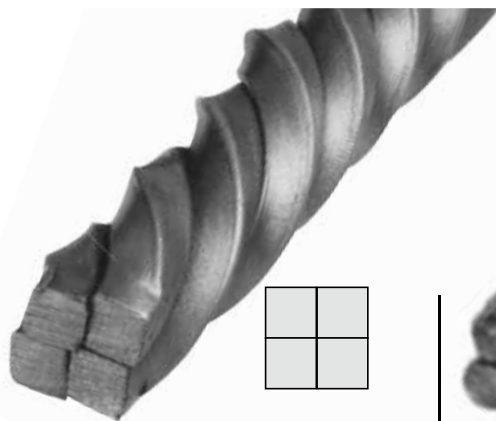

L 2000 mm
I18/F/1 Φ 12 x 12 mm
I18/F/2 Φ 16 x 16 mm
I18/F/3 Φ 20 x 20 mm
I18/F/4 Φ 24 x 24 mm
I18/F/5 Φ 28 x 28 mm



2700 mm
I19/1 Φ 16 mm
I19/2 Φ 20 mm
I19/3 Φ 30 mm



L 3000 mm
626/3 Φ 12 mm
626/4 Φ 14 mm
626/5 Φ 16 mm
626/6 Φ 18 mm
626/7 Φ 20 mm
626/8 Φ 22 mm
626/17 Φ 24 mm
626/9 Φ 26 mm

Fune solcata
a CALDO
Iron Ropes
HOT crossed



L 2000 mm
I17/10 Φ 14 x 14 mm
I17/11 Φ 16 x 16 mm
I17/12 Φ 18 x 18 mm
I17/13 Φ 20 x 20 mm
I17/14 Φ 30 x 30 mm

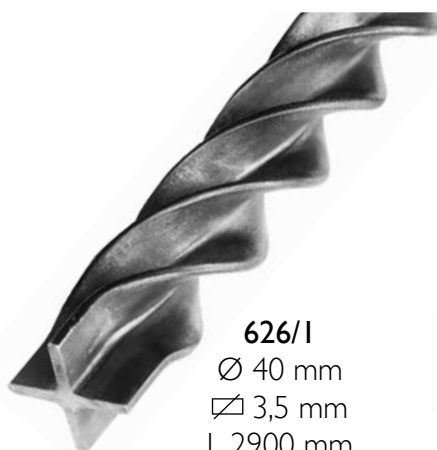

626/1
 Φ 40 mm
 ∇ 3,5 mm
L 2900 mm

626/2
 Φ 50 mm
 ∇ 5 mm
L 2900 mm

Tubo
Tube



I18/F/6
 Φ 20 x 20 mm
L 2000 mm

Tubo rigato disponibile anche 6000 mm
Grooved round tube Also available 6000 mm



1794/9
 Φ 40 mm
Spess./Thickn. 2 mm
L 3000 mm
1794/10
 Φ 30 mm
Spess./Thickn. 1,5 mm
L 3000 mm

Battuto
sui 2 lati
Hammered
on 2 sides

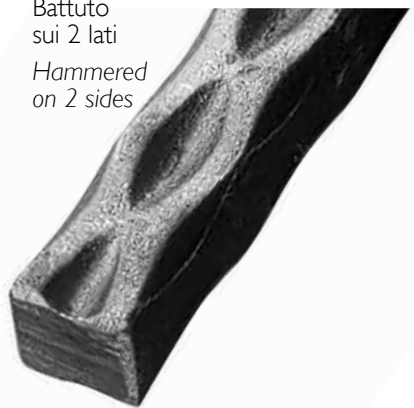

I370/13
 Φ 12 x 12 mm
 L 3000 mm
I370/14
 Φ 14 x 14 mm
 L 3000 mm



L 3000 mm
1806/1 Φ 50 x 50 mm
1806/2 Φ 40 x 40 mm
1806/3 Φ 30 x 30 mm
 L 6000 mm
1806/4 Φ 50 x 50 mm
1806/5 Φ 40 x 40 mm
1806/6 Φ 30 x 30 mm



L 3000 mm
622/1 ∇ 12 x 6 mm
622/2 ∇ 8 x 8 mm
622/3 ∇ 14 x 8 mm
622/4 ∇ 16 x 6 mm
622/5 ∇ 16 x 8 mm
622/6 ∇ 14 x 6 mm

Battuto
sui 2 lati
Hammered
on 2 sides



I370/10
 Φ 30 x 30 mm
 L 3000 mm



L 3000 mm
1806/7 Φ 50 x 50 mm
1806/8 Φ 40 x 40 mm
1806/9 Φ 30 x 30 mm
 L 6000 mm
1806/10 Φ 50 x 50 mm
1806/11 Φ 40 x 40 mm
1806/12 Φ 30 x 30 mm



I326/1
 Φ 6 mm
 L 2000 mm

Battuto
su un lato
Hammered
on one side

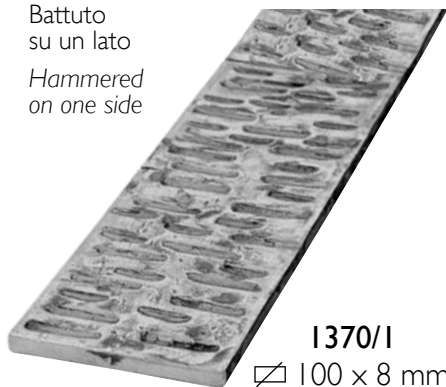

I370/1
 ∇ 100 x 8 mm
 L 2000 mm
I370/2
 ∇ 120 x 8 mm
 L 2000 mm

Battuto
su un lato
Hammered
on one side

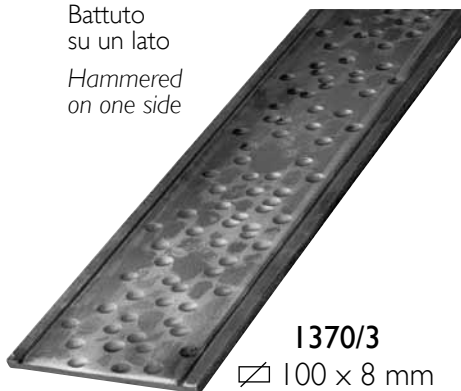

I370/3
 ∇ 100 x 8 mm
 L 2000 mm
I370/4
 ∇ 120 x 8 mm
 L 2000 mm



1839/5
 ∇ 40 x 6 mm
 L 3000 mm
1839/6
 ∇ 40 x 8 mm
 L 3000 mm

FERRO COMMERCIALE - COMMERCIAL IRON

L 4000 mm

1842/1	∅ 10 × 3 mm	1842/35	∅ 16 × 4 mm
1842/2	∅ 10 × 4 mm	1842/36	∅ 16 × 5 mm
1842/3	∅ 10 × 5 mm	1842/37	∅ 16 × 6 mm
1842/4	∅ 10 × 6 mm	1842/38	∅ 16 × 8 mm
1842/5	∅ 12 × 3 mm	1842/39	∅ 16 × 10 mm
1842/6	∅ 12 × 4 mm	1842/40	∅ 18 × 3 mm
1842/7	∅ 12 × 5 mm	1842/41	∅ 18 × 4 mm
1842/8	∅ 12 × 6 mm	1842/42	∅ 18 × 5 mm
1842/9	∅ 12 × 8 mm	1842/43	∅ 18 × 6 mm
1842/10	∅ 14 × 3 mm	1842/44	∅ 18 × 8 mm
1842/11	∅ 14 × 4 mm	1842/45	∅ 20 × 3 mm
1842/12	∅ 14 × 5 mm	1842/46	∅ 20 × 4 mm
1842/25	∅ 14 × 6 mm	1842/47	∅ 20 × 5 mm
1842/26	∅ 14 × 8 mm	1842/48	∅ 20 × 6 mm
1842/27	∅ 14 × 10 mm	1842/49	∅ 25 × 3 mm
1842/28	∅ 15 × 3 mm	1842/50	∅ 25 × 4 mm
1842/29	∅ 15 × 4 mm	1842/51	∅ 25 × 5 mm
1842/30	∅ 15 × 5 mm	1842/52	∅ 25 × 6 mm
1842/31	∅ 15 × 6 mm	1842/53	∅ 30 × 3 mm
1842/32	∅ 15 × 8 mm	1842/54	∅ 30 × 4 mm
1842/33	∅ 15 × 10 mm	1842/55	∅ 30 × 5 mm
1842/34	∅ 16 × 3 mm		



L 3000 mm

1368/11	∅ 10 × 5 mm
1368/12	∅ 12 × 6 mm
1368/13	∅ 14 × 8 mm
1368/14	∅ 16 × 4 mm
1368/15	∅ 20 × 4 mm
1368/16	∅ 20 × 6 mm
1368/17	∅ 25 × 4 mm
1368/18	∅ 30 × 8 mm
1368/19	∅ 40 × 8 mm

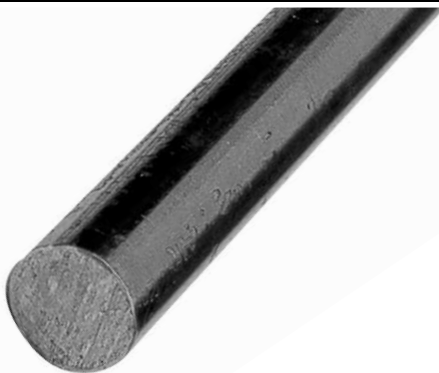

L 4000 mm

1842/13	∅ 6 mm
1842/14	∅ 8 mm
1842/15	∅ 10 mm

L 3000 mm

1368/6	∅ 6 mm
1368/7	∅ 8 mm
1368/8	∅ 10 mm
1368/9	∅ 12 mm
1368/10	∅ 14 mm
1368/23	∅ 16 mm
1368/24	∅ 18 mm
1368/25	∅ 20 mm

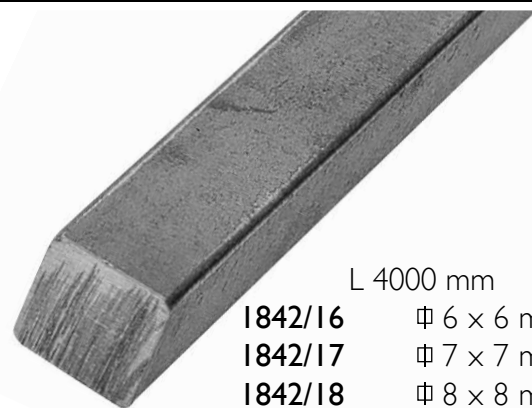

L 4000 mm

1842/16	∅ 6 × 6 mm
1842/17	∅ 7 × 7 mm
1842/18	∅ 8 × 8 mm
1842/19	∅ 9 × 9 mm
1842/20	∅ 10 × 10 mm
1842/21	∅ 11 × 11 mm
1842/22	∅ 12 × 12 mm
1842/23	∅ 13 × 13 mm
1842/24	∅ 14 × 14 mm

L 3000 mm

1368/1	∅ 6 × 6 mm
1368/2	∅ 8 × 8 mm
1368/3	∅ 10 × 10 mm
1368/4	∅ 12 × 12 mm
1368/5	∅ 14 × 14 mm
1368/20	∅ 16 × 16 mm
1368/21	∅ 18 × 18 mm
1368/22	∅ 20 × 20 mm



BARRE SAGOMATE - SHAPED BARS

COMPENDIUM 2011

Art. GD/86/I

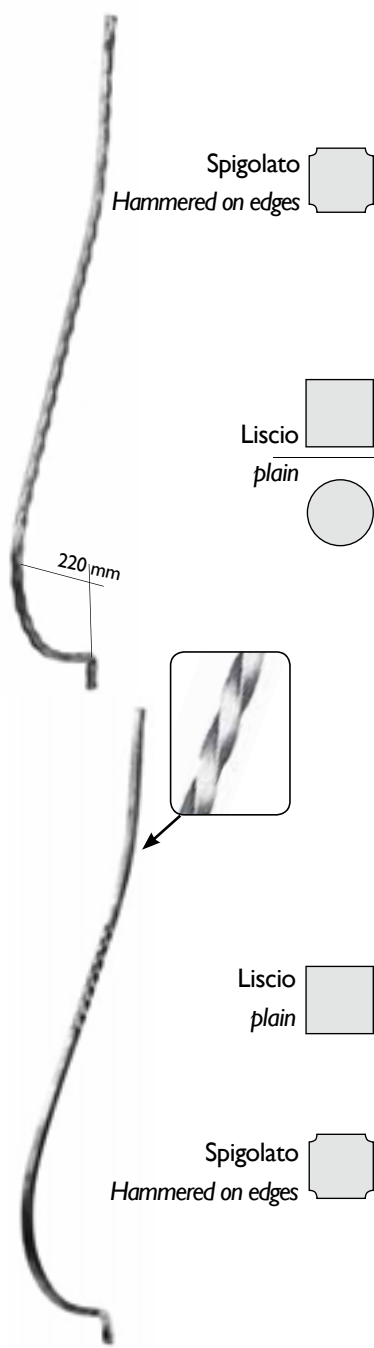

Sez./Sec.	Cod.art./Art.no. H 900 mm	Cod.art./Art.no. H 1000 mm	Cod.art./Art.no. H 1200 mm	Cod.art./Art.no. H 1500 mm
Φ 12 x 12 mm	47/6	47/14	47/24	-
Φ 14 x 14 mm	47/12	47/20	1158/5	-

Sez./Sec.	Cod.art./Art.no. H 900 mm	Cod.art./Art.no. H 1000 mm	Cod.art./Art.no. H 1200 mm	Cod.art./Art.no. H 1500 mm
Φ 12 x 12 mm	47/15	47/17	47/29	47/32
Φ 14 x 14 mm	47/16	47/18	-	-
Ø 12 mm	47/25	47/28	-	-
Ø 14 mm	47/26	47/19	47/30	47/33
Ø 16 mm	47/27	-	47/31	47/34



Sez./Sec.	Cod.art./Art.no. H 900 mm	Cod.art./Art.no. H 1000 mm	Cod.art./Art.no. H 1200 mm	Cod.art./Art.no. H 1500 mm
Φ 12 x 12 mm	47/3	47/3/1000	47/35	47/36
Φ 14 x 14 mm	47/9	47/22	-	-

Sez./Sec.	Cod.art./Art.no. H 900 mm	Cod.art./Art.no. H 1000 mm	Cod.art./Art.no. H 1200 mm	Cod.art./Art.no. H 1500 mm
Φ 12 x 12 mm	47/37	47/38	-	-
Φ 14 x 14 mm	-	-	-	-



- | | |
|------------------------------------------------------------|--------------------------------------------------------|
| Art. 1308/1
Φ 12 x 12 mm
H 360 mm
L 180 mm | Art. 1308/11
Ø 14 mm
H 360 mm
L 180 mm |
| Art. 1308/2
Φ 14 x 14 mm
H 360 mm
L 180 mm | Art. 1308/7
Ø 16 mm
H 360 mm
L 180 mm |
- ARTEFERRO**

- | | | |
|------------------------------------------------------------|-------------------------------------------------------------|-------------------------------------------------------|
| Art. 1308/3
Φ 12 x 12 mm
H 360 mm
L 180 mm | Art. 1308/12
Φ 12 x 12 mm
H 350 mm
L 150 mm | Art. 1308/8
Ø 14 mm
H 350 mm
L 150 mm |
| Art. 1308/4
Φ 14 x 14 mm
H 360 mm
L 180 mm | Art. 1308/13
Φ 14 x 14 mm
H 350 mm
L 150 mm | Art. 1308/9
Ø 16 mm
H 350 mm
L 150 mm |



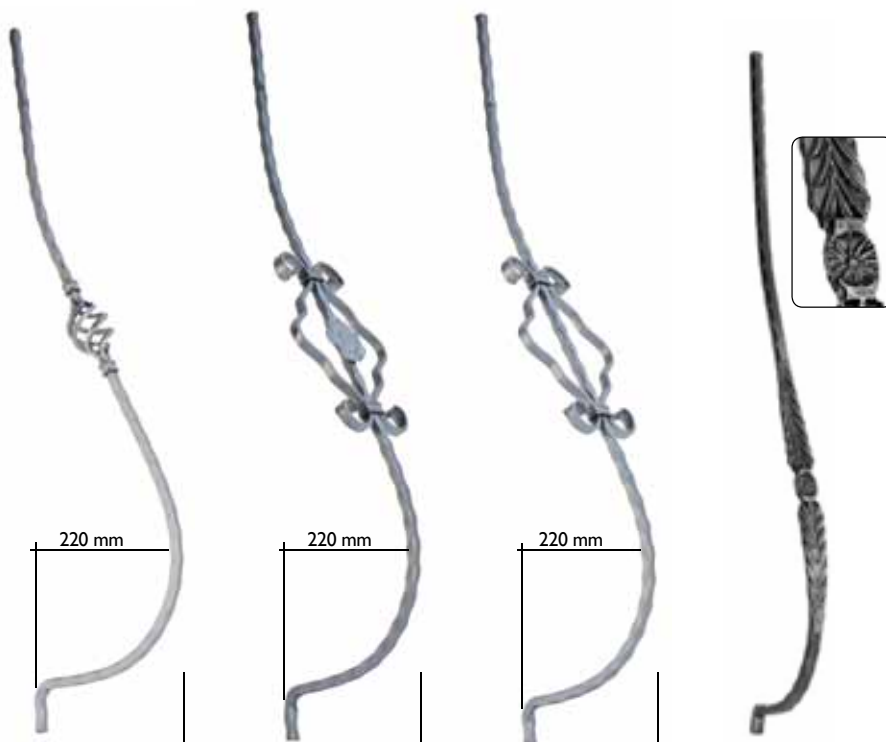
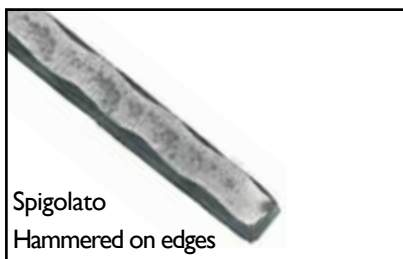

		Cod.art./Art.no.	Cod.art./Art.no.	Cod.art./Art.no.	Cod.art./Art.no.
H 900 mm	Φ 12 x 12 mm	47/5	47/1	47/2	572/5
	Φ 14 x 14 mm	47/11	47/7	47/8	572/7
H 1000 mm	Φ 12 x 12 mm	47/13	-	-	-
	Φ 14 x 14 mm	47/23	-	-	-
H 1200 mm	Φ 12 x 12 mm	-	-	-	572/6
	Φ 14 x 14 mm	1158/6	-	-	572/8

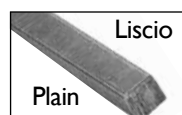

Altezza/Height	Sez./Sec. Φ 14 mm
	Cod.art./Art.no.
H 810 mm	1784/5
H 910 mm	1784/6
H 950 mm	1784/7
H 1050 mm	1784/8
H 1500 mm	1784/9



FORGIATI
HOT
FORGED

Ø = diameter



Art. 1783/8
Ø 12 x 12 mm
H 1000 mm



Art. 1783/5
Ø 12 x 12 mm
H 1000 mm



Art. 1783/6
Ø 12 x 12 mm
H 1000 mm



Art. 1783/7
Ø 12 mm
H 1000 mm



Art. 1783/3
Ø 12 mm
H 1000 mm

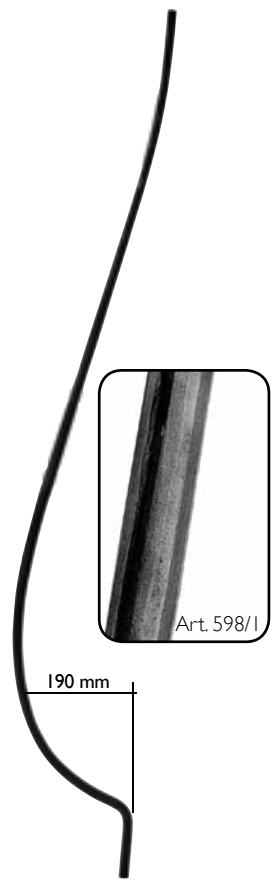

Art. 1783/4
Ø 12 mm
H 1000 mm



ARTEFERRO



Art. GD86/1
 Φ 12 x 12 mm
 H 1000 mm
 L 230 mm



Art. 1782/8
 Φ 14 x 14 mm
 H 1000 mm
 L 210 mm



Art. 1782/6
 Φ 14 x 14 mm
 H 1000 mm
 L 130 mm



Art. 1782/7
 Φ 14 x 14 mm
 H 1000 mm
 L 210 mm



Art. 1782/9
 Φ 14 x 14 mm
 H 1000 mm
 L 250 mm



LISCIO - PLAIN
 Φ 14 x 14 mm

H 1000 mm
Art. 1782/1

H 1200 mm
Art. 1158/8



240 mm

LISCIO - PLAIN
 Φ 14 x 14 mm

H 910 mm
Art. 1784/1

H 1000 mm
Art. 1784/2

H 1200 mm
Art. 1784/3

H 1500 mm
Art. 1784/4



LISCIO - PLAIN

H 820 mm
Art. 70/D/4
 Φ 14 x 14 mm

H 900 mm
Art. 70/D/5
 Φ 14 x 14 mm

Art. 1782/2
 ∇ 25 x 8 mm
Art. 1782/3

∇ 30 x 8 mm
 H 1000 mm
Art. 70/D/9
 Φ 14 x 14 mm

Art. 1782/4
 ∇ 25 x 8 mm
Art. 1782/5

∇ 30 x 8 mm



ARTEFERRO



220 mm

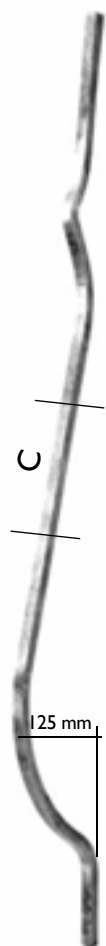

Liscio
Plain

Spigolato
Hamm. on edges

Diamantato
Diamond
hammer profile

Corteccia
Tree Bark effect

Attorc. Centr.
Centre twist

		Cod.art./Art.no.	Cod.art./Art.no.	Cod.art./Art.no.	Cod.art./Art.no.	Cod.art./Art.no.
H 900 mm	Φ 12 x 12 mm	64/D/4	-	-	-	64/D/3
	Φ 14 x 14 mm	64/D/9	-	-	-	64/D/8
	Ø 12 mm	64/D/5	-	-	-	-
	Ø 14 mm	64/D/6	-	-	-	-
H 1000 mm	Φ 12 x 12 mm	1779/7	1780/7	1137/11	1780/15	64/D/7
	Φ 14 x 14 mm	1779/8	1780/8	1137/12	1780/16	64/D/10
	Ø 12 mm	1779/15	-	-	-	-
	Ø 14 mm	1779/16	-	-	-	-
H 1200 mm	Φ 12 x 12 mm	-	-	1137/13	-	-
	Φ 14 x 14 mm	-	-	1137/14	-	-





125 mm

125 mm

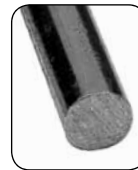
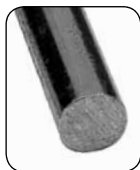

		Cod.art./Art.no.	Cod.art./Art.no.	Cod.art./Art.no.	Cod.art./Art.no.	Cod.art./Art.no.
H 900 mm	Φ 12 x 12 mm	-	64/H/9	-	-	578/17
	Φ 14 x 14 mm	-	64/H/10	-	-	578/19
	Ø 12 mm	572/1	-	-	578/13	-
	Ø 14 mm	572/3	-	-	578/15	-
H 1000 mm	Φ 12 x 12 mm	-	64/H/9/S	1137/7	-	578/18/SI
	Φ 14 x 14 mm	-	64/H/10/S	1137/8	-	-
H 1200 mm	Φ 12 x 12 mm	-	64/H/19	1137/9	-	578/18
	Φ 14 x 14 mm	-	64/H/20	1137/10	-	578/20
	Ø 12 mm	572/2	-	-	578/14	-
	Ø 14 mm	572/4	-	-	578/16	-



BARRE SAGOMATE (Pance) - SHAPED BARS



ARTEFERRO

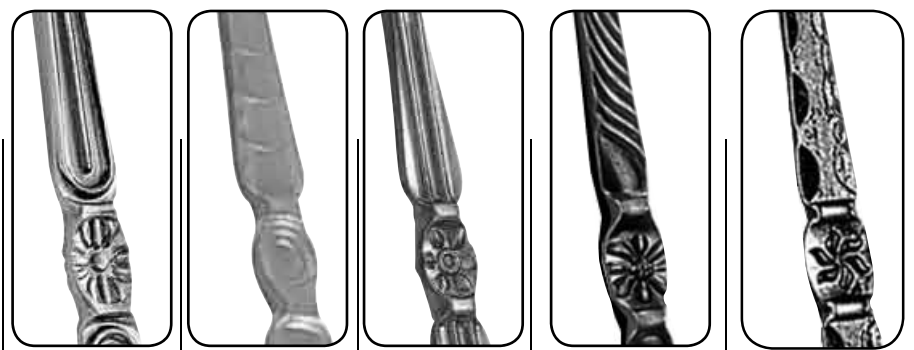
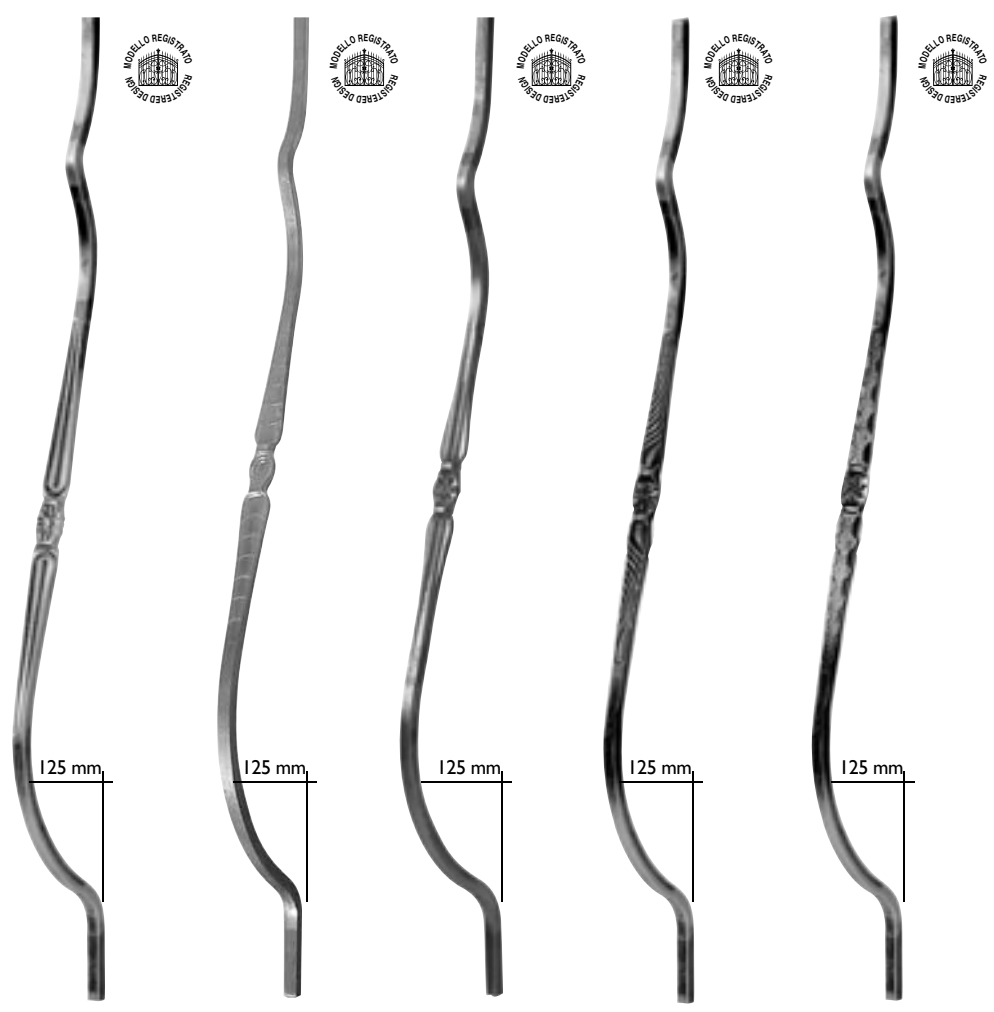

Liscio



Plain



Spigolato



Hammered on edges

Corteccia



Tree bark effect

	Cod.art./Art.no.	Cod.art./Art.no.	Cod.art./Art.no.	Cod.art./Art.no.	Cod.art./Art.no.
Sez./Sec.	H 1000 mm	H 1000 mm	H 1000 mm	H 1000 mm	H 1000 mm
∅ 12 x 12 mm	1701/13	1702/13	1705/13	NEW0026	NEW0037
∅ 14 x 14 mm	1701/14	1702/14	1705/14	NEW0027	NEW0039
∅ 12 mm	1779/13	1779/11	1779/9	-	-
∅ 14 mm	1779/14	1779/12	1779/10	-	-

∅ 12 x 12 mm	1780/5	1780/3	1780/1	-	-
∅ 14 x 14 mm	1780/6	1780/4	1780/2	-	-

∅ 12 x 12 mm	1780/13	1780/11	1780/9	-	-
∅ 14 x 14 mm	1780/14	1780/12	1780/10	-	-



H 1300 mm
Art. 98/B/1
 Φ 14 x 14 mm



H 900 mm
Art. 47/4
 Φ 12 x 12 mm
Art. 47/10
 Φ 14 x 14 mm



H 900 mm
Art. 591/1
 Φ 12 x 12 mm
Art. 591/2
 Φ 14 x 14 mm

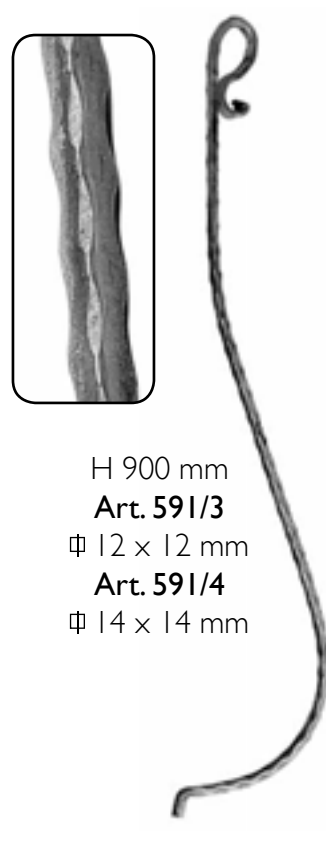

H 900 mm
Art. 591/3
 Φ 12 x 12 mm
Art. 591/4
 Φ 14 x 14 mm



ARTEFERRO

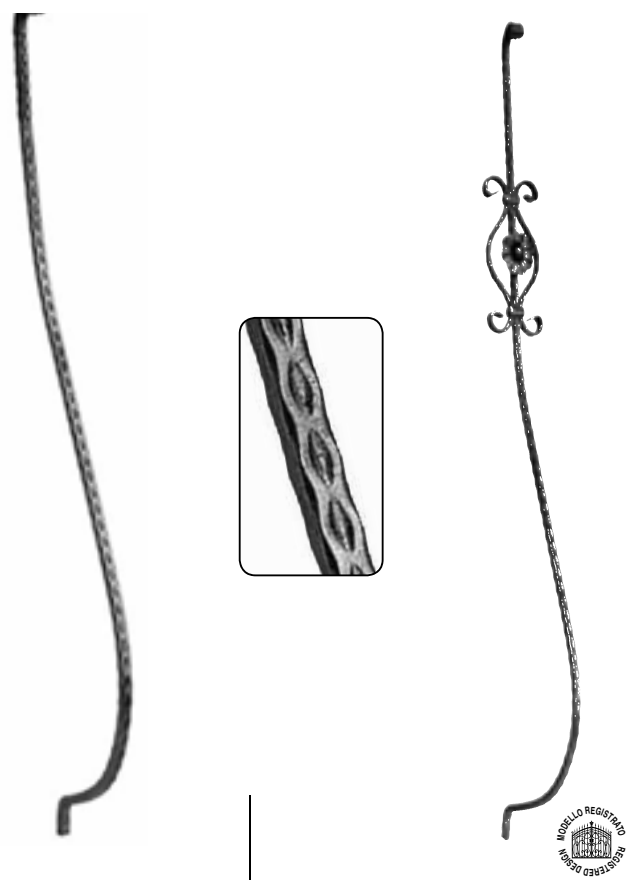

	Cod.art./Art.no.	Cod.art./Art.no.	Cod.art./Art.no.	Cod.art./Art.no.
Altezza/Height	Φ 12 x 12 mm	Φ 14 x 14 mm	Φ 12 x 12 mm	Φ 14 x 14 mm
H 1000 mm	1269/7	1269/11	-	-
H 1200 mm	1269/8	1269/12	1269/1	1269/4
H 1500 mm	1269/9	1269/13	1269/2	1269/5
H 1800 mm	1269/10	1269/14	1269/3	1269/6



Art. 589/4
 □ 40 x 4 mm
 H 800 mm



Art. 1789/1
 □ 31 x 5 mm
 H 800 mm



Art. 1789/2
 □ 32 x 5 mm
 H 800 mm



Art. 1789/4
 □ 31 x 5 mm
 H 800 mm



Art. 1789/5
 □ 31 x 5 mm
 H 800 mm



Art. 1789/3
 □ 27 x 5 mm
 H 800 mm



Lavorati su
 un lato

Design on
 one side



Art. 1787/5
 □ 30 x 8 mm
 H 1000 mm



Art. 1787/2
 □ 31 x 5 mm
 H 1000 mm



Art. 1787/3
 □ 32 x 5 mm
 H 1000 mm



Art. 1787/4
 □ 31 x 5 mm
 H 1000 mm



Art. 1787/1
 □ 31 x 5 mm
 H 1000 mm



Art. 1787/7
 □ 30 x 8 mm
 H 1000 mm

Art. 1787/8
 □ 40 x 8 mm
 H 1000 mm



Art. 1787/9
 □ 30 x 8 mm
 H 1000 mm

Art. 1787/10
 □ 40 x 8 mm
 H 1000 mm

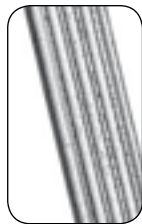

140 mm

140 mm

140 mm

140 mm

	Cod.art./Art.no.	Cod.art./Art.no.	Cod.art./Art.no.	Cod.art./Art.no.
Sez./Sec.	H 800 mm	H 800 mm	H 800 mm	H 800 mm
▧ 20 x 4 mm	-	-	46/1	46/2
▧ 25 x 4 mm	-	-	46/3	46/4
▧ 30 x 5 mm	1276/1	-	-	-
▧ 40 x 4 mm	-	589/5	46/5	46/6
▧ 50 x 4 mm	-	-	46/7	46/8

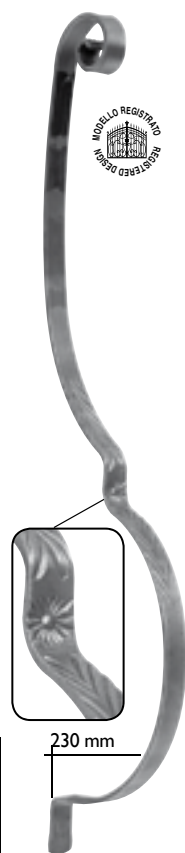
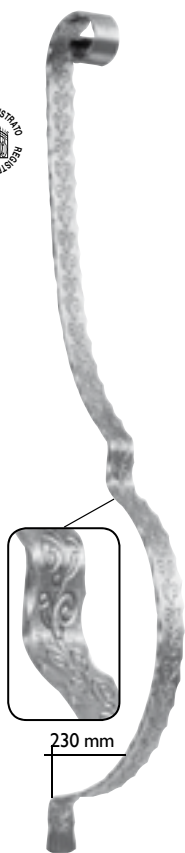

230 mm

230 mm

230 mm

230 mm

230 mm

230 mm

	Cod.art./Art.no.	Cod.art./Art.no.	Cod.art./Art.no.	Cod.art./Art.no.	Cod.art./Art.no.	Cod.art./Art.no.
Sez./Sec.	H 1000 mm	H 1000 mm	H 1000 mm	H 1000 mm	H 1000 mm	H 1000 mm
▧ 30 x 8 mm	-	-	1791/1	1791/3	44/13	44/11
▧ 40 x 8 mm	1791/5	1791/6	1791/2	1791/4	44/14	44/12

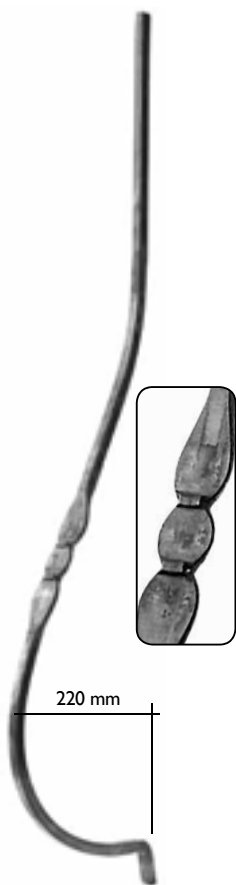

Art. 586/14
 Φ 12 x 12 mm
 H 900 mm



Art. 586/16
 Φ 14 mm
 H 1000 mm



Art. 586/17
 Φ 14 mm
 H 1000 mm

Forgiati
*Hot
 forged*



Art. 1783/1
 Φ 14 x 14 mm
 H 1000 mm



Art. 1783/2
 Φ 14 x 14 mm
 H 1000 mm

Art. 586/15
 Φ 14 x 14 mm
 H 900 mm

Art. 586/6
 Φ 12 x 12 mm
 H 1000 mm

Art. 586/7
 Φ 14 x 14 mm
 H 1000 mm

Art. 586/12
 Φ 12 mm
 H 1000 mm

Art. 586/13
 Φ 14 mm
 H 1000 mm



Art. 1275/3
 \square 40 x 4 mm
 H 605 mm
 L 310 mm



Art. 1275/1
 \square 40 x 4 mm
 H 1150 mm
 L 425 mm



ARTEFERRO



ARTEFERRO

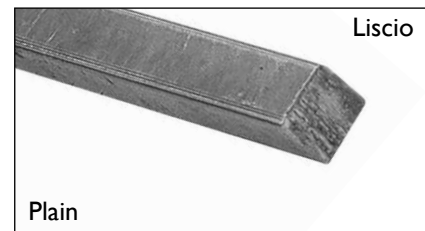

Liscio

Plain

	Cod.art./Art.no.	Cod.art./Art.no.	Cod.art./Art.no.	Cod.art./Art.no.
Altezza/Height	∅ 12 x 12 mm	∅ 14 x 14 mm	∅ 12 x 12 mm	∅ 14 x 14 mm
H 830 mm	587/1	587/3	587/21	587/23
H 1000 mm	587/2	587/4	587/22	587/24
H 1200 mm	587/5	587/8	587/25	587/28
H 1500 mm	587/6	587/9	587/26	587/29
H 1800 mm	587/7	587/10	587/27	587/30



Spigolato

Hammered on edges

H 830 mm	587/11	587/13	587/31	587/33
H 1000 mm	587/12	587/14	587/32	587/34
H 1200 mm	587/15	587/18	587/35	587/38
H 1500 mm	587/16	587/19	587/36	587/39
H 1800 mm	587/17	587/20	587/37	587/40



H 1000 mm
Art. 586/8
 ∅ 12 x 12 mm
Art. 586/9
 ∅ 14 x 14 mm
Art. 586/10
 ∅ 12 mm
Art. 586/11
 ∅ 14 mm

Art. 586/18
 ∅ 14 x 14 mm
 H 1000 mm

Art. 586/19
 ∅ 14 x 14 mm
 H 1000 mm

Art. 586/20
 ∅ 14 x 14 mm
 H 1000 mm



ARTEFERRO

BARRE SAGOMATE (Pance) - SHAPED BARS

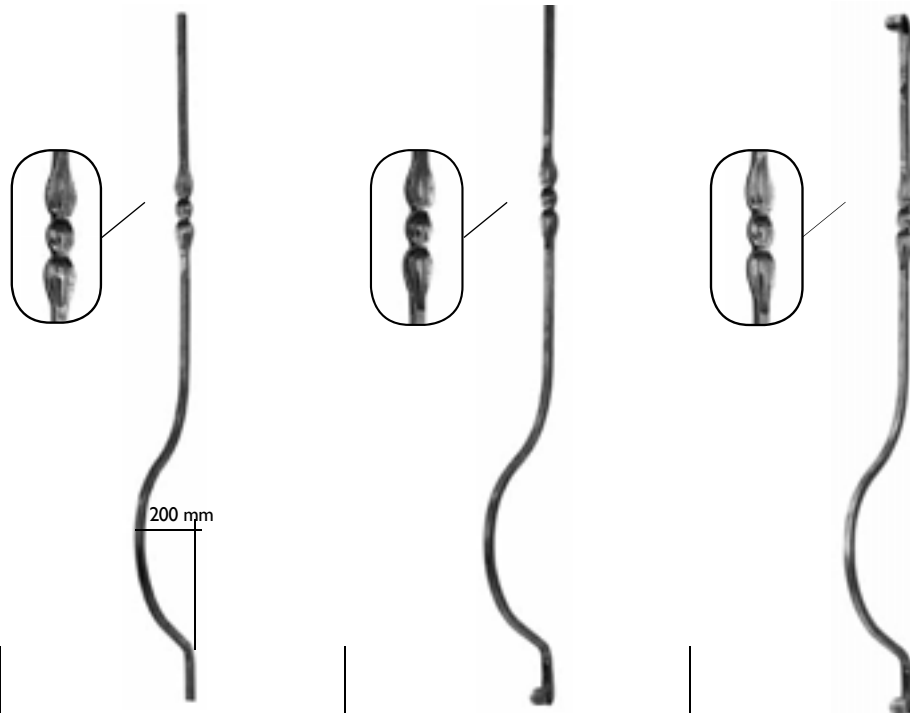

	Cod.art./Art.no.	Cod.art./Art.no.	Cod.art./Art.no.	Cod.art./Art.no.	Cod.art./Art.no.	Cod.art./Art.no.
Altezza/Height	Φ 12 x 12 mm	Φ 14 x 14 mm	Φ 12 x 12 mm	Φ 14 x 14 mm	Φ 12 x 12 mm	Φ 14 x 14 mm
H 1000 mm	1265/11	1265/15	1265/29	1265/33	1265/47	1265/51
H 1200 mm	1265/12	1265/16	1265/30	1265/34	1265/48	1265/52
H 1500 mm	1265/13	1265/17	1265/31	1265/35	1265/49	1265/53
H 1800 mm	1265/14	1265/18	1265/32	1265/36	1265/50	1265/54

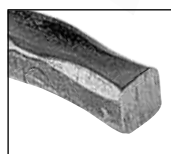

H 1000 mm	1267/11	1267/15	1267/29	1267/33	1267/47	1267/51
H 1200 mm	1267/12	1267/16	1267/30	1267/34	1267/48	1267/52
H 1500 mm	1267/13	1267/17	1267/31	1267/35	1267/49	1267/53
H 1800 mm	1267/14	1267/18	1267/32	1267/36	1267/50	1267/54



H 1000 mm	1268/11	1268/15	1268/29	1268/33	1268/47	1268/51
H 1200 mm	1268/12	1268/16	1268/30	1268/34	1268/48	1268/52
H 1500 mm	1268/13	1268/17	1268/31	1268/35	1268/49	1268/53
H 1800 mm	1268/14	1268/18	1268/32	1268/36	1268/50	1268/54



Altezza/Height	Cod.art./Art.no.
H 830 mm	134/29
H 1000 mm	134/30
H 1200 mm	134/37
H 1500 mm	134/38
H 1800 mm	134/39

Altezza/Height	Cod.art./Art.no.
H 830 mm	134/31
H 1000 mm	134/32
H 1200 mm	134/40
H 1500 mm	134/41
H 1800 mm	134/42



Altezza/Height	Cod.art./Art.no.
H 830 mm	134/33
H 1000 mm	134/34
H 1200 mm	134/43
H 1500 mm	134/44
H 1800 mm	134/45

Altezza/Height	Cod.art./Art.no.
H 830 mm	134/35
H 1000 mm	134/36
H 1200 mm	134/46
H 1500 mm	134/47
H 1800 mm	134/48



Altezza/Height	Cod.art./Art.no.
H 820 mm	70/D/6
H 900 mm	70/D/7
H 1200 mm	70/D/8



ARTEFERRO

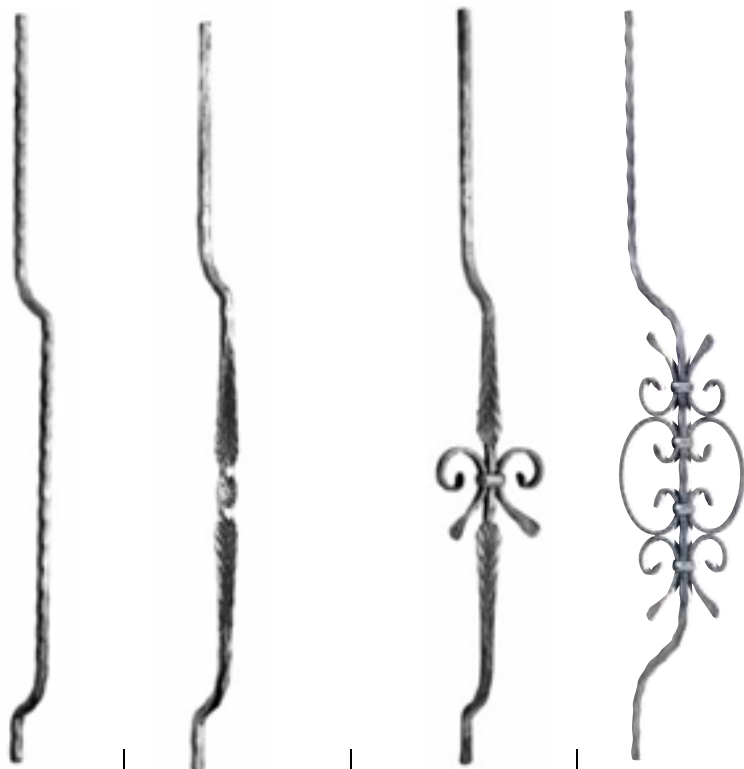

L 140 mm

L 225 mm

Altezza/Height	Sez./Sec.	Cod.art./Art.no.	Cod.art./Art.no.	Cod.art./Art.no.	Cod.art./Art.no.
H 900 mm	Φ 12 x 12 mm	64/H/1	64/H/3	64/H/5	64/H/7
	Φ 14 x 14 mm	64/H/2	64/H/4	64/H/6	64/H/8
H 1200 mm	Φ 12 x 12 mm	64/H/11	64/H/13	64/H/15	64/H/17
	Φ 14 x 14 mm	64/H/12	64/H/14	64/H/16	64/H/18



Art. 64/D/1
 Φ 12 x 12 mm
 H 900 mm
 L 105 mm



Art. 64/D/2
 Φ 12 x 12 mm
 H 900 mm
 L 137 mm

Φ 14 x 14 mm
Art. 1271/1
 H 1200 mm
Art. 1271/2
 H 1400 mm
Art. 1271/3
 H 1600 mm
Art. 1271/4
 H 1800 mm

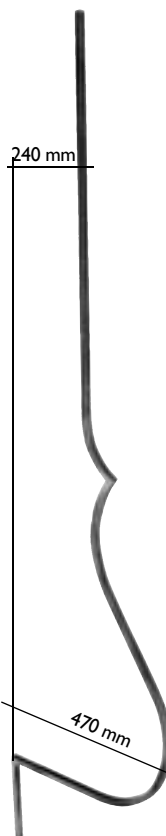

Φ 14 x 14 mm
Art. 1271/5
 H 1200 mm
Art. 1271/6
 H 1400 mm
Art. 1271/7
 H 1600 mm
Art. 1271/8
 H 1800 mm

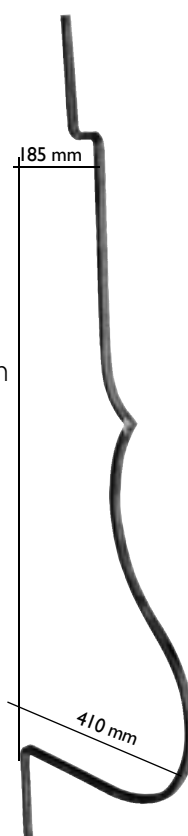

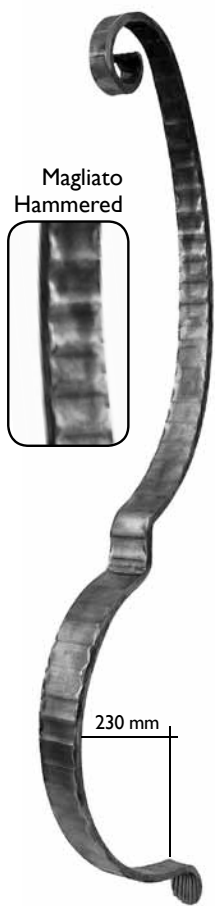

Art. 109/2
 □ 60 x 8 mm
 H 1000 mm

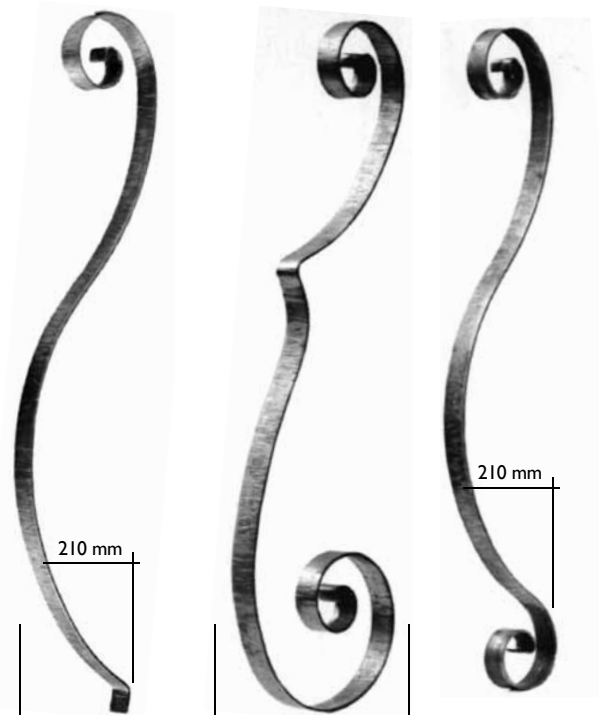

	Cod.art./Art.no.	Cod.art./Art.no.	Cod.art./Art.no.
Sez./Sec.	H 1000 mm	H 1000 mm	H 950 mm
□ 25 x 4 mm	45/15	45/9	45/1
□ 30 x 5 mm	45/17	-	45/3
□ 40 x 4 mm	45/19	45/11	45/5
□ 50 x 4 mm	45/21	45/13	45/7
□ 25 x 4 mm	45/16	45/10	45/2
□ 30 x 5 mm	45/18	-	45/4
□ 40 x 4 mm	45/20	45/12	45/6
□ 50 x 4 mm	45/22	45/14	45/8

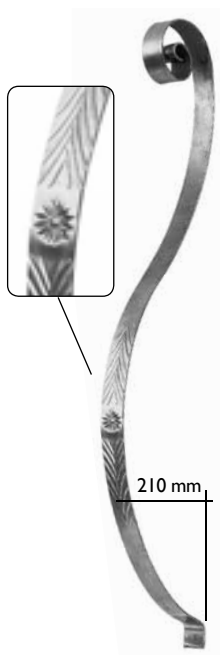

H 910 mm
Art. 1785/4
 □ 30 x 5 mm
Art. 1785/5
 □ 40 x 4 mm



□ 30 x 4 mm
Art. 1785/1
 H 900 mm
Art. 1785/2
 H 1000 mm



□ 30 x 4 mm
Art. 1785/3
 H 820 mm



Art. 46/10
 □ 50 x 3 mm
 H 870 mm



Art. 46/12
 □ 50 x 3 mm
 H 900 mm



Art. 46/11
 □ 50 x 3 mm
 H 900 mm

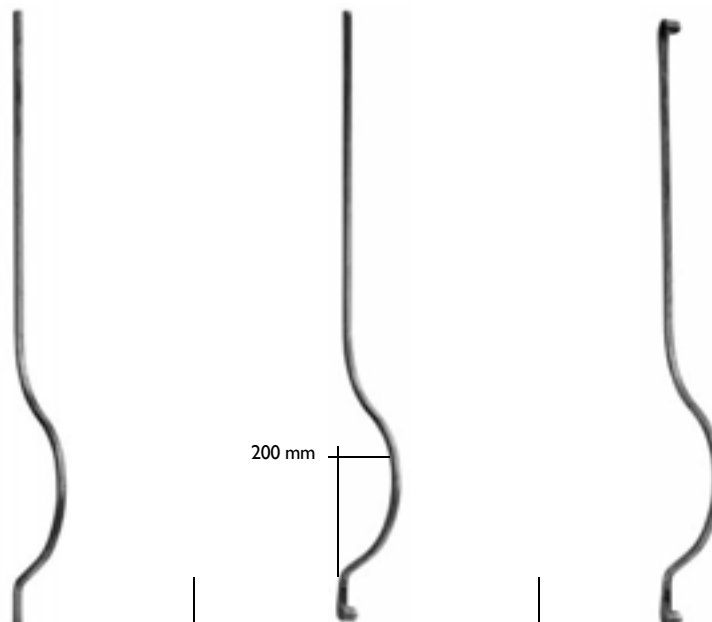

	Cod.art./Art.no.	Cod.art./Art.no.	Cod.art./Art.no.	Cod.art./Art.no.	Cod.art./Art.no.	Cod.art./Art.no.
Altezza/Height	Φ 12 x 12 mm	Φ 14 x 14 mm	Φ 12 x 12 mm	Φ 14 x 14 mm	Φ 12 x 12 mm	Φ 14 x 14 mm
H 830 mm	1265/1	1265/6	1265/19	1265/24	1265/37	1265/42
H 1000 mm	1265/2	1265/7	1265/20	1265/25	1265/38	1265/43
H 1200 mm	1265/3	1265/8	1265/21	1265/26	1265/39	1265/44
H 1500 mm	1265/4	1265/9	1265/22	1265/27	1265/40	1265/45
H 1800 mm	1265/5	1265/10	1265/23	1265/28	1265/41	1265/46

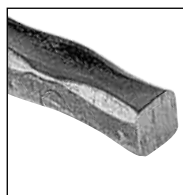

H 830 mm	1267/1	1267/6	1267/19	1267/24	1267/37	1267/42
H 1000 mm	1267/2	1267/7	1267/20	1267/25	1267/38	1267/43
H 1200 mm	1267/3	1267/8	1267/21	1267/26	1267/39	1267/44
H 1500 mm	1267/4	1267/9	1267/22	1267/27	1267/40	1267/45
H 1800 mm	1267/5	1267/10	1267/23	1267/28	1267/41	1267/46



H 830 mm	1268/1	1268/6	1268/19	1268/24	1268/37	1268/42
H 1000 mm	1268/2	1268/7	1268/20	1268/25	1268/38	1268/43
H 1200 mm	1268/3	1268/8	1268/21	1268/26	1268/39	1268/44
H 1500 mm	1268/4	1268/9	1268/22	1268/27	1268/40	1268/45
H 1800 mm	1268/5	1268/10	1268/23	1268/28	1268/41	1268/46

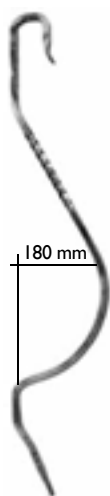

Art. 46/9
Φ 12 x 12 mm
H 900 mm



Art. 1264/1
Φ 12 x 12 mm
H 480 mm
Art. 1264/2
Φ 14 x 14 mm
H 480 mm



Art. 1264/3
Φ 12 x 12 mm
H 480 mm
Art. 1264/4
Φ 14 x 14 mm
H 480 mm

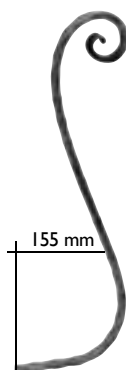

Art. 1264/5
Φ 12 x 12 mm
H 510 mm

Altezza/Height	Cod.art./Art.no.
Φ 12 x 12 mm	
H 900 mm	1274/1
H 1000 mm	1274/2
H 1200 mm	1274/3
H 1400 mm	1274/4
H 1600 mm	1274/5
H 1800 mm	1274/6

Art. 746/1
Ghisa
Cast iron

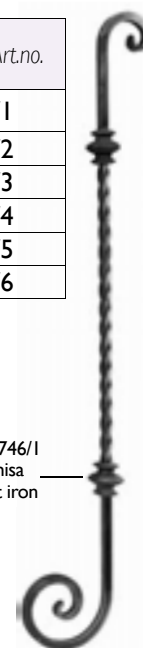

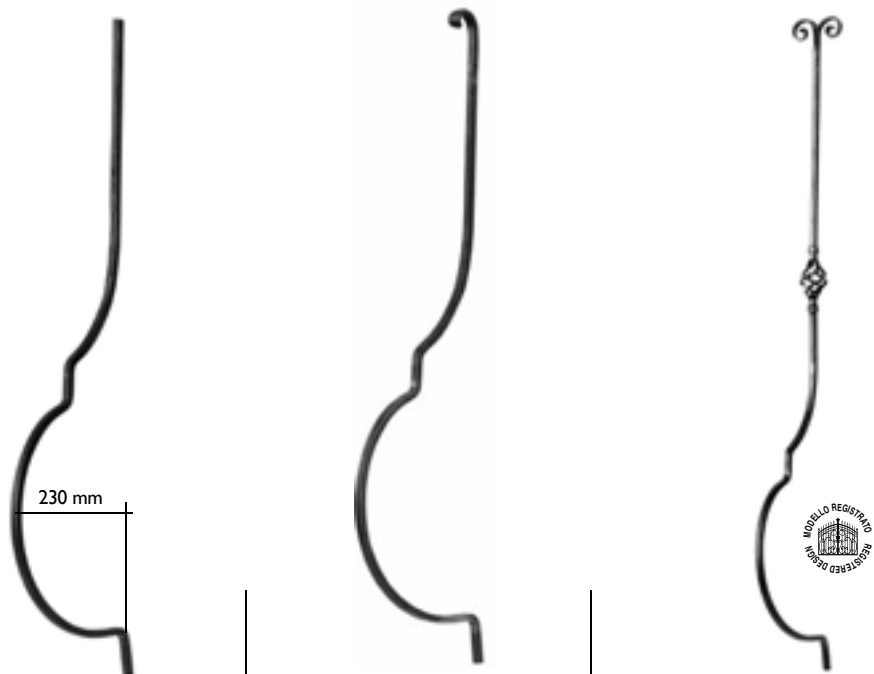

	Cod.art./Art.no.	Cod.art./Art.no.	Cod.art./Art.no.	Cod.art./Art.no.	Cod.art./Art.no.	Cod.art./Art.no.
Altezza/Height	∅ 12 x 12 mm	∅ 14 x 14 mm	∅ 12 x 12 mm	∅ 14 x 14 mm	∅ 12 x 12 mm	∅ 14 x 14 mm
H 830 mm	1270/19	1270/24	-	-	-	-
H 1000 mm	1270/20	1270/25	1270/29	1270/33	-	-
H 1200 mm	1270/21	1270/26	1270/30	1270/34	1273/1	1273/5
H 1400 mm	1273/25	1273/27	-	-	1273/2	1273/6
H 1500 mm	1270/22	1270/27	1270/31	1270/35	-	-
H 1600 mm	1273/26	1273/28	-	-	1273/3	1273/7
H 1800 mm	1270/23	1270/28	1270/32	1270/36	1273/4	1273/8

H 830 mm	1270/1	1270/6	-	-	-	-
H 1000 mm	1270/2	1270/7	1270/11	1270/15	-	-
H 1200 mm	1270/3	1270/8	1270/12	1270/16	1273/17	1273/21
H 1400 mm	1273/39	1273/41	-	-	1273/18	1273/22
H 1500 mm	1270/4	1270/9	1270/13	1270/17	-	-
H 1600 mm	1273/40	1273/42	-	-	1273/19	1273/23
H 1800 mm	1270/5	1270/10	1270/14	1270/18	1273/20	1273/24

H 830 mm	-	-	-	-	-	-
H 1000 mm	1273/29	1273/34	-	-	-	-
H 1200 mm	1273/30	1273/35	-	-	1273/9	1273/13
H 1400 mm	1273/31	1273/36	-	-	1273/10	1273/14
H 1500 mm	-	-	-	-	-	-
H 1600 mm	1273/32	1273/37	-	-	1273/11	1273/15
H 1800 mm	1273/33	1273/38	-	-	1273/12	1273/16

Art. 153/1
∅ 12 mm
H 900 mm
L 230 mm

Art. 142/4
∅ 20 x 4 mm
H 800 mm

Art. 589/3
∅ 20 x 8 mm
H 900 mm

Liscio - plain
Art. 589/1
∅ 12 x 12 mm
H 900 mm

Spigolato
Hammered
on edges
Art. 589/2
∅ 12 x 12 mm
H 900 mm

Art. 1264/6
∅ 16 x 16 mm
fori - holes
∅ 18 mm
120 x 700 mm
base con foro
base with hole
∅ 16 mm

Art. 64/1
∅ 25 x 4 mm
H 850 mm



RICCI GRANDI - BIG SCROLLS

COMPENDIUM 2011

Art. 1309/5 Art. 1314/1
Art. 1808/3 Art. 1298/1

FORGIATI - HOT FORGEDS

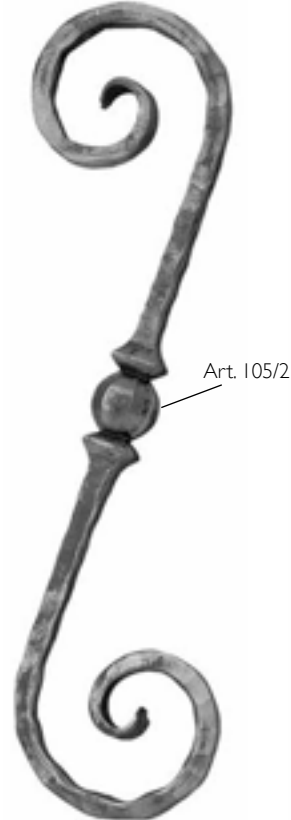
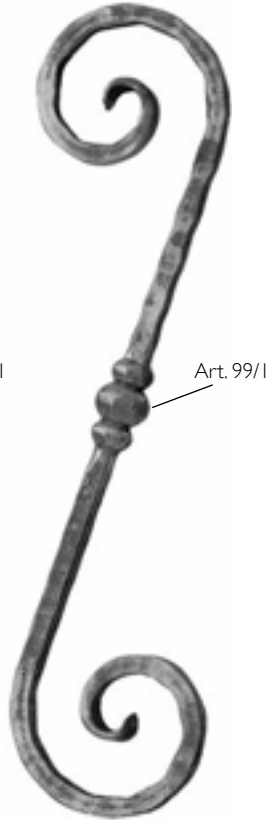
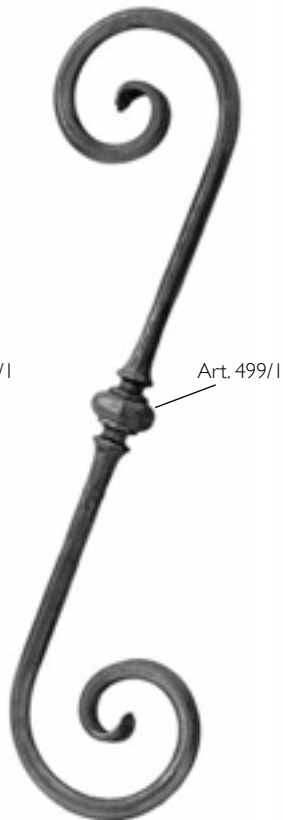
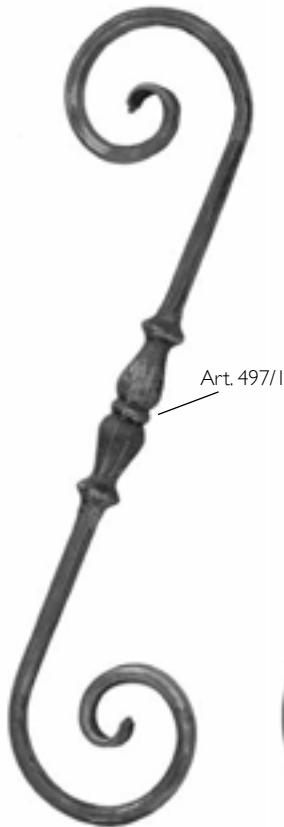

Art. 1309/1
 Ø 12 mm
 H 450 mm
 L 110 mm

Art. 1309/2
 Ø 12 mm
 H 450 mm
 L 110 mm

Art. 1309/3
 Ø 12 x 12 mm
 H 450 mm
 L 110 mm

Art. 1309/4
 Ø 12 x 12 mm
 H 450 mm
 L 110 mm

Art. 1309/5
 H 450 mm
 L 110 mm



RICCI GRANDI - BIG SCROLLS

ARTEFERRO



Art. 1314/1
□ 60 x 20 mm
H 370 mm
L 500 mm



Art. 1314/2
□ 60 x 20 mm
H 260 mm
L 330 mm

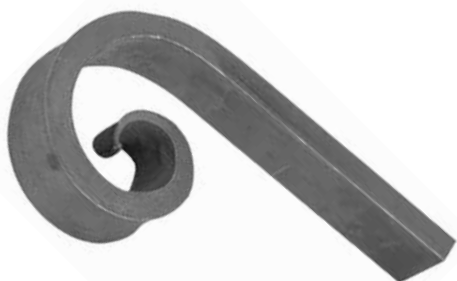

Art. 1314/3
□ 60 x 20 mm
H 160 mm
L 320 mm



FUCINATI A CALDO - HOT FORGED SCROLLS



Art. 1315/1
 □ 25 x 12 mm
 H 640 mm
 L 260 mm



Art. 1808/3
 □ 25 x 12 mm
 H 640 mm
 L 260 mm



Art. 1808/4
 □ 25 x 12 mm
 H 305 mm
 L 135 mm



Art. 6092/3
 ∅ 20 x 20 mm
 H 370 mm
 L 110 mm



Art. 6112/2
 □ 30 x 20 mm
 H 350 mm
 L 150 mm



Art. 6092/1
 □ 20 x 15 mm
 H 410 mm
 L 130 mm



Art. 6092/2
 □ 30 x 15 mm
 H 500 mm
 L 150 mm

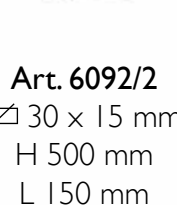

Art. 6092/5
 ∅ 20 x 20 mm
 H 700 mm
 L 300 mm



Art. 6092/4
 ∅ 20 x 20 mm
 H 500 mm
 L 220 mm

Art. 6112/4
 ∅ 20 x 20 mm
 H 250 mm
 L 150 mm



Art. 1809/6
 ∅ 30 x 30 mm
 H 800 mm
 L 550 mm

Art. 1809/5
 ∅ 30 x 30 mm
 H 650 mm
 L 330 mm

RICCI GRANDI - BIG SCROLLS



ARTEFERRO

RICCI GRANDI - BIG SCROLLS

Art. GD264/4

∅ 14 x 8 mm
H 390 mm
L 120 mm



Art. GD264/3

∅ 14 x 8 mm
H 500 mm
L 315 mm



Art. GD264/2

∅ 14 x 8 mm
H 560 mm
L 315 mm



Art. GD264/1

∅ 14 x 8 mm
H 710 mm
L 320 mm



**RICCIO
BATTUTO A CALDO**
HOT FORGED ENDS

Art. GD264/5

∅ 14 x 8 mm
H 180 mm
L 75 mm



Art. 3002/7

∅ 14 x 14 mm
H 170 mm
L 105 mm



Art. 3002/6

∅ 14 x 14 mm
H 530 mm
L 215 mm

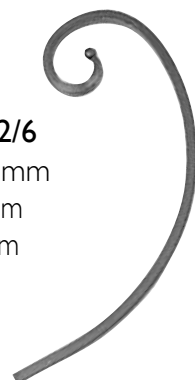

ARTEFERRO

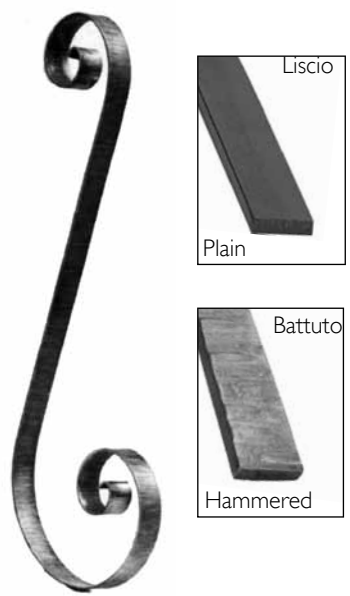

H 720 x 250 mm
Art. 75/11 \sphericalangle 20 x 4 mm
Art. 75/13 \sphericalangle 25 x 4 mm
Art. 75/15 \sphericalangle 30 x 5 mm
Art. 75/17 \sphericalangle 40 x 4 mm
Art. 75/19 \sphericalangle 50 x 4 mm

H 720 x 250 mm
Art. 75/12 \sphericalangle 20 x 4 mm
Art. 75/14 \sphericalangle 25 x 4 mm
Art. 75/16 \sphericalangle 30 x 5 mm
Art. 75/18 \sphericalangle 40 x 4 mm
Art. 75/20 \sphericalangle 50 x 4 mm



Art. 88/Q/4
 \varnothing 12 x 12 mm
 H 450 mm
 L 120 mm

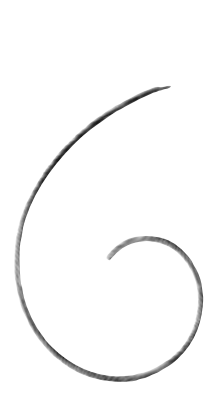

Art. 688/2
 \varnothing 12 mm
 H 300 mm
 L 400 mm
Art. 688/3
 \varnothing 12 mm
 H 550 mm
 L 350 mm



Art. 88/L/4
 \varnothing 12 x 12 mm
 H 560 mm
 L 80 mm

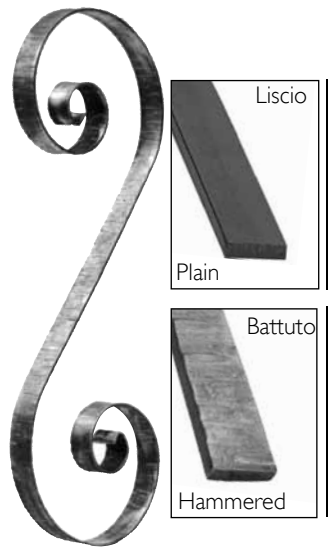

H 720 x 220 mm
Art. 75/1 \sphericalangle 20 x 4 mm
Art. 75/3 \sphericalangle 25 x 4 mm
Art. 75/5 \sphericalangle 30 x 5 mm
Art. 75/7 \sphericalangle 40 x 4 mm
Art. 75/9 \sphericalangle 50 x 4 mm

H 720 x 220 mm
Art. 75/2 \sphericalangle 20 x 4 mm
Art. 75/4 \sphericalangle 25 x 4 mm
Art. 75/6 \sphericalangle 30 x 5 mm
Art. 75/8 \sphericalangle 40 x 4 mm
Art. 75/10 \sphericalangle 50 x 4 mm



Art. 72/4
 \varnothing 12 x 12 mm
 H 600 mm
 L 280 mm



ARTEFERRO

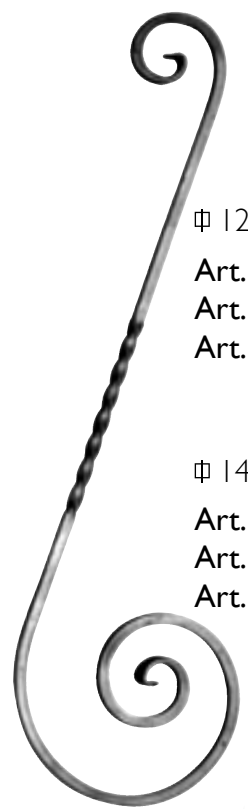

\varnothing 12 x 12 mm
Art. 78/B/7 H 820 mm
Art. 78/B/8 H 900 mm
Art. 78/B/9 H 1200 mm

\varnothing 14 x 14 mm
Art. 78/B/10 H 820 mm
Art. 78/B/11 H 900 mm
Art. 78/B/12 H 1200 mm



\varnothing 12 x 12 mm
Art. 71/1 H 720 mm
Art. 71/2 H 820 mm
Art. 71/4 H 1200 mm
Art. 71/6 H 1800 mm

\varnothing 12 x 12 mm
Art. 71/3 H 900 mm
Art. 71/5 H 1500 mm

L 250 mm



Art. 645/5
 \varnothing 8 x 8 mm
 H 900 mm
 L 120 mm



ARTEFERRO



H 720 mm - L 120 mm

- Art. 79/7 \sphericalangle 16 x 4 mm
- Art. 79/8 \sphericalangle 20 x 4 mm
- Art. 79/9 \sphericalangle 20 x 6 mm
- Art. 79/10 Φ 8 x 8 mm



Φ 12 x 12 mm

- Art. 72/1 720 x 145 mm
- Art. 72/2 820 x 145 mm
- Art. 72/3 900 x 145 mm



\sphericalangle 20 x 4 mm

- Art. 72/7 720 x 190 mm
- Art. 72/8 820 x 190 mm
- Art. 72/9 900 x 190 mm

\sphericalangle 20 x 6 mm

- Art. 72/10 720 x 190 mm
- Art. 72/11 820 x 190 mm
- Art. 72/12 900 x 190 mm



Art. 1310/7

Φ 14 mm
H 530 mm
L 225 mm



Art. 1275/2

\sphericalangle 40 x 4 mm
H 415 mm
L 145 mm



Art. 1275/4

\sphericalangle 40 x 4 mm
H 180 mm
L 130 mm



\sphericalangle 14 x 14 mm - L 270 mm

Altezza/Height	Cod.art./Art.no.
1000 mm	1298/1
1200 mm	1298/2
1500 mm	1298/3



\sphericalangle 14 x 14 mm - L 270 mm

Altezza/Height	Cod.art./Art.no.
1000 mm	1298/4
1200 mm	1298/5
1500 mm	1298/6



Φ 14 mm - L 155 mm

Altezza/Height	Cod.art./Art.no.
1000 mm	1310/1
1200 mm	1310/2
1500 mm	1310/3



Φ 14 mm - L 285 mm

Altezza/Height	Cod.art./Art.no.
1000 mm	1310/4
1200 mm	1310/5
1500 mm	1310/6

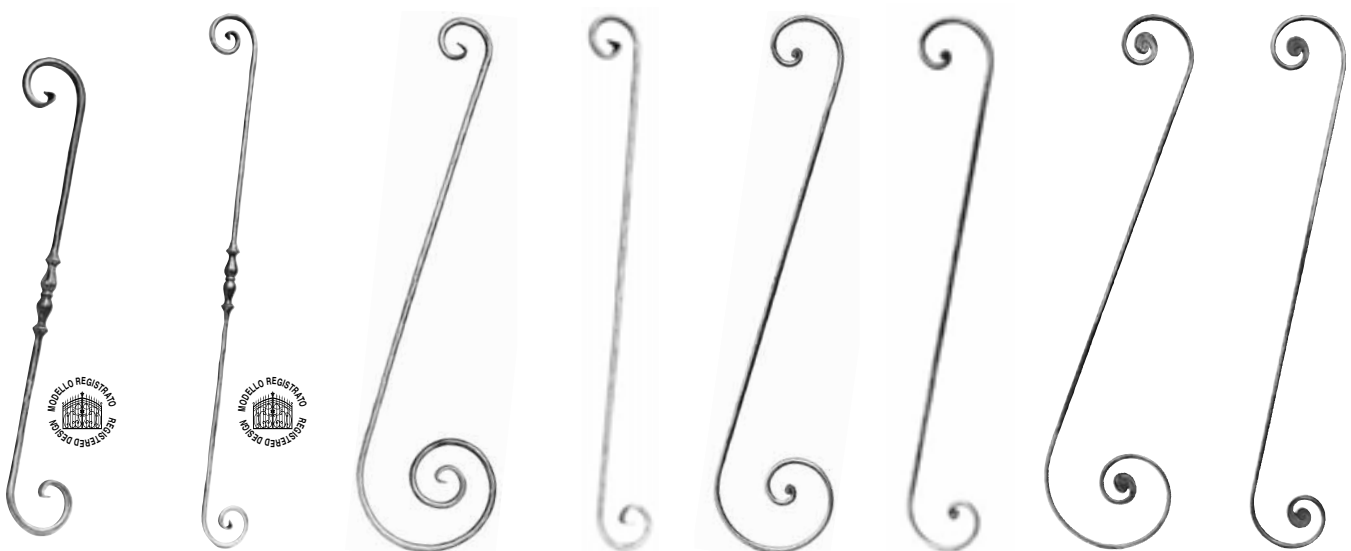

Art. 498/1 Ø 12 mm H 650 mm Forgiati a caldo/Hot forged	Art. 498/2 Ø 900 mm H 900 mm	Art. 646/1 Ø 12 mm H 900 mm L 250 mm	Art. 646/2 Ø 12 mm H 900 L 100 mm	Art. 648/4 Ø 10 mm H 900 L 200 mm	Art. 648/1 Ø 10 mm H 900 L 120 mm	Art. 642/2 Ø 10 mm H 900 mm L 220 mm	Art. 642/1 Ø 10 mm H 900 mm L 130 mm
-------------------------------------------------------------------------	-------------------------------------------	------------------------------------------------------	---------------------------------------------------	---------------------------------------------------	---------------------------------------------------	------------------------------------------------------	------------------------------------------------------



Art. 88/C/3 20 x 4 mm H 820 mm L 235 mm	Art. 92/D/3 12 x 6 mm H 550 mm L 112 mm	Art. 92/D/4 12 x 6 mm H 550 mm L 112 mm	Art. 1298/7 attorcigliato/twisted 14 x 14 mm H 500 mm L 150 mm	Art. 1298/8 attorcigliato/twisted 14 x 14 mm H 560 mm L 240 mm	Art. 1292/1 Ø 10 mm H 900 mm L 230 mm	Art. 1292/2 Ø 10 mm H 900 mm L 230 mm	Art. 1292/3 Ø 10 mm H 900 mm L 230 mm
---------------------------------------------------------	---------------------------------------------------------	---------------------------------------------------------	-----------------------------------------------------------------------------------	-----------------------------------------------------------------------------------	-------------------------------------------------------	-------------------------------------------------------	-------------------------------------------------------

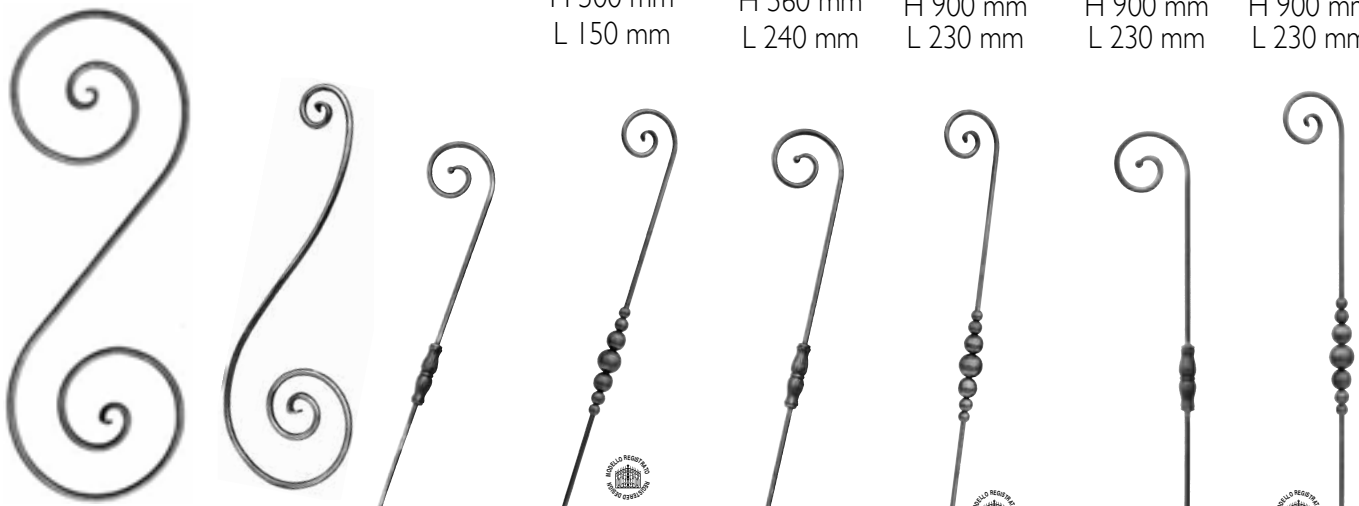

Art. 634/1 Ø 14 mm L 340 mm	Art. 540/1 Ø 12 mm L 250 mm	Art. 596/3 Ø 12 mm H 900 mm L 250 mm	Art. 1213/1 Ø 12 mm H 1000 mm L 250 mm	Art. 596/2 Ø 12 mm H 900 mm L 150 mm	Art. 1213/2 Ø 12 mm H 1000 mm L 150 mm	Art. 596/1 Ø 12 mm H 900 mm L 150 mm	Art. 1213/3 Ø 12 mm H 1000 mm L 150 mm
------------------------------------------	------------------------------------------	------------------------------------------------------	--------------------------------------------------------	------------------------------------------------------	--------------------------------------------------------	------------------------------------------------------	--------------------------------------------------------

spigolato/hammered



Ø 12 mm
Art. 152/1
 H 720 mm
 L 200 mm
Art. 152/2
 H 830 mm
 L 200 mm
Art. 152/3
 H 900 mm
 L 200 mm



Ø 12 mm
Art. 152/8
 H 720 mm
 L 130 mm
Art. 152/9
 H 830 mm
 L 130 mm
Art. 152/10
 H 900 mm
 L 130 mm



Ø 12 mm
Art. 152/5
 H 720 mm
 L 130 mm
Art. 152/6
 H 830 mm
 L 130 mm
Art. 152/7
 H 900 mm
 L 130 mm



Art. 92/C/1
 12 x 6 mm
 H 620 mm
 L 230 mm

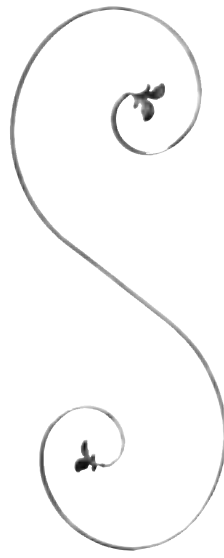

Art. 92/C/2
 12 x 6 mm
 H 890 mm
 L 350 mm



Art. 1808/1
 25 x 12 mm
 H 700 mm
 L 180 mm



Art. 1808/2
 25 x 12 mm
 H 700 mm
 L 250 mm

Forgiati a caldo/Hot forged



Ø 16 x 16 mm



Art. 1811/3
 H 610 mm
 L 160 mm

Art. 1811/4
 H 635 mm
 L 160 mm



Art. 1811/7
 H 610 mm
 L 160 mm

Art. 1811/8
 H 635 mm
 L 160 mm



Ø 12 x 12 mm



Art. 1811/1
 H 445 mm
 L 160 mm



Art. 1811/5
 H 445 mm
 L 160 mm



Ø 16 x 16 mm



Art. 1811/2
 H 475 mm
 L 120 mm



Art. 1811/6
 H 475 mm
 L 120 mm

Ø 16 x 16 mm



Art. 1811/9
 H 720 mm
 L 280 mm



Art. 639/1
 H 720 mm
 L 280 mm

Ø 20 x 20 mm

Art. 1811/12
 H 470 mm
 L 255 mm

Art. 1811/10
 H 750 mm
 L 335 mm

Art. 1811/11
 H 790 mm
 L 335 mm

Art. 639/2
 H 470 mm
 L 255 mm

Art. 639/3
 H 750 mm
 L 335 mm

Art. 639/4
 H 790 mm
 L 335 mm



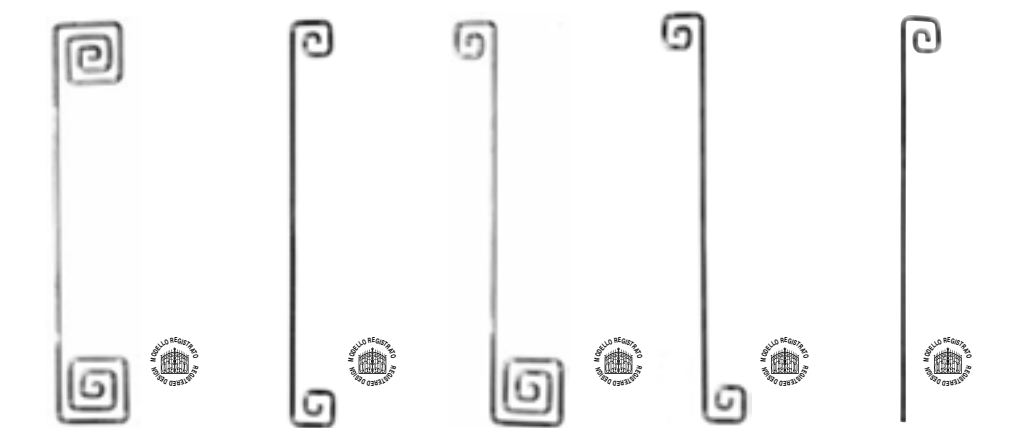

Art. 1146/1 Φ 12 x 12 mm H 1000 mm L 185 mm
Art. 1146/2 Φ 12 x 12 mm H 1000 mm L 110 mm
Art. 1146/3 Φ 12 x 12 mm H 1000 mm L 280 mm
Art. 1146/4 Φ 12 x 12 mm H 1000 mm L 205 mm
Art. 1146/5 Φ 12 x 12 mm H 1000 mm L 110 mm

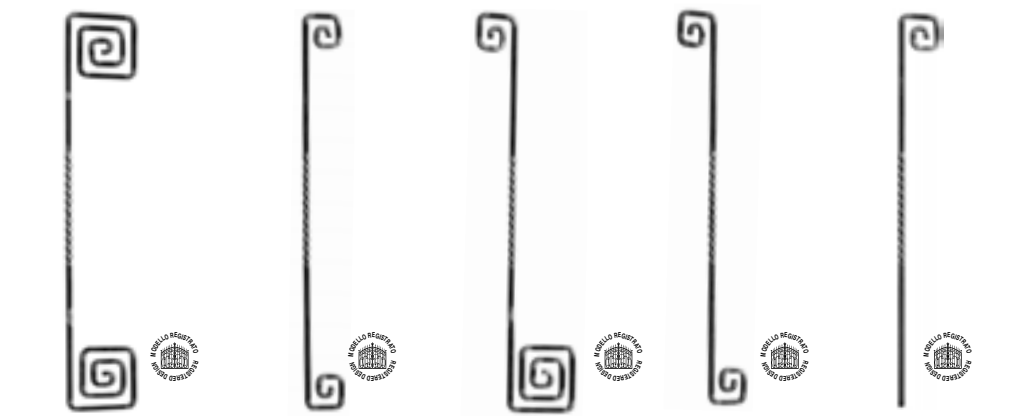

Art. 1147/1 Φ 12 x 12 mm H 1000 mm L 185 mm
Art. 1147/2 Φ 12 x 12 mm H 1000 mm L 110 mm
Art. 1147/3 Φ 12 x 12 mm H 1000 mm L 280 mm
Art. 1147/4 Φ 12 x 12 mm H 1000 mm L 205 mm
Art. 1147/5 Φ 12 x 12 mm H 1000 mm L 110 mm

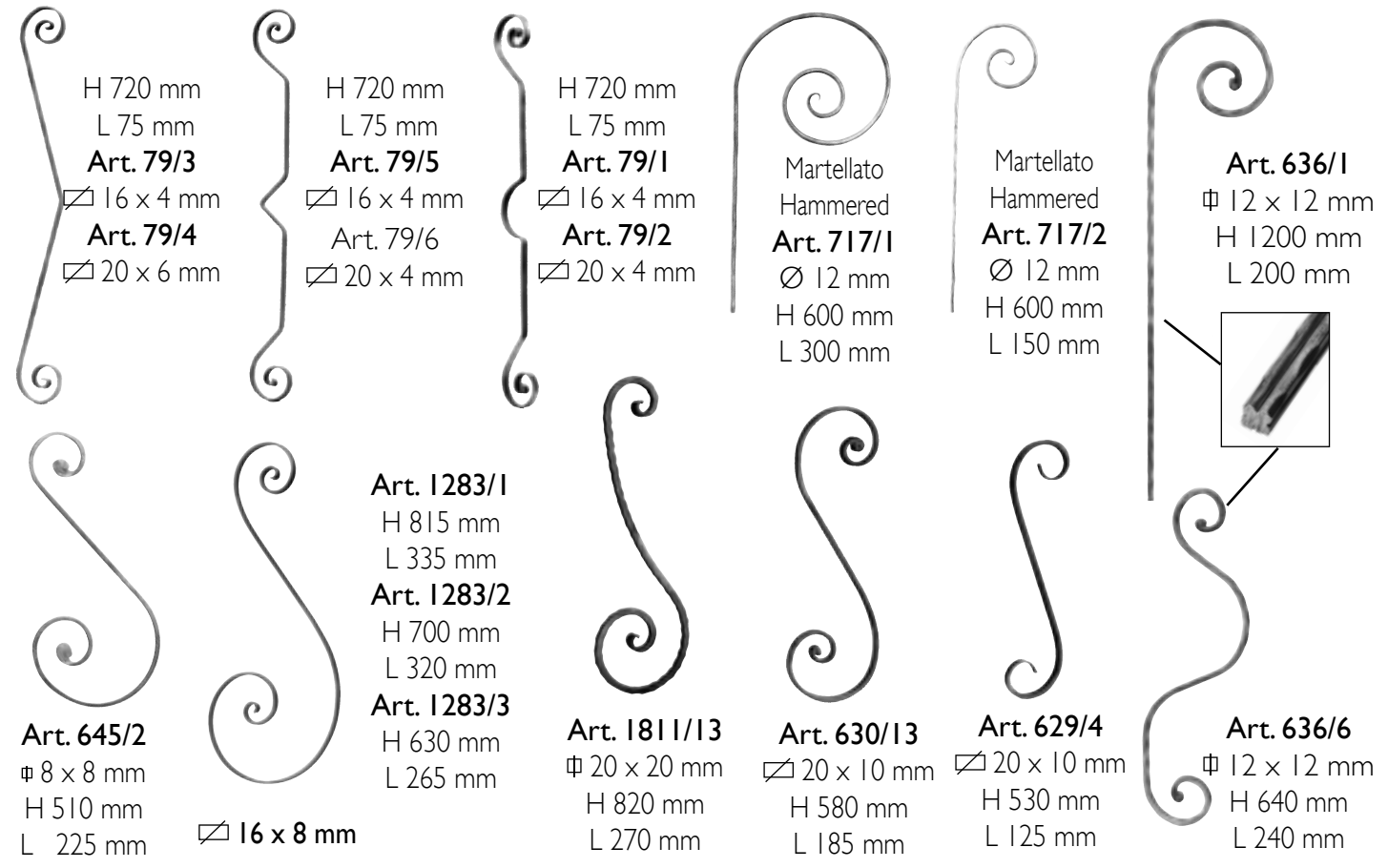

Art. 79/3 H 720 mm L 75 mm ∇ 16 x 4 mm
Art. 79/4 ∇ 20 x 6 mm
Art. 79/5 H 720 mm L 75 mm ∇ 16 x 4 mm
Art. 79/6 ∇ 20 x 4 mm
Art. 79/1 H 720 mm L 75 mm ∇ 16 x 4 mm
Art. 79/2 ∇ 20 x 4 mm
Art. 717/1 Martellato Hammered Φ 12 mm H 600 mm L 300 mm
Art. 717/2 Martellato Hammered Φ 12 mm H 600 mm L 150 mm
Art. 636/1 Φ 12 x 12 mm H 1200 mm L 200 mm
Art. 645/2 Φ 8 x 8 mm H 510 mm L 225 mm
Art. 1283/1 H 815 mm L 335 mm
Art. 1283/2 H 700 mm L 320 mm
Art. 1283/3 H 630 mm L 265 mm
Art. 1811/13 Φ 20 x 20 mm H 820 mm L 270 mm
Art. 630/13 ∇ 20 x 10 mm H 580 mm L 185 mm
Art. 629/4 ∇ 20 x 10 mm H 530 mm L 125 mm
Art. 636/6 Φ 12 x 12 mm H 640 mm L 240 mm



ARTEFERRO

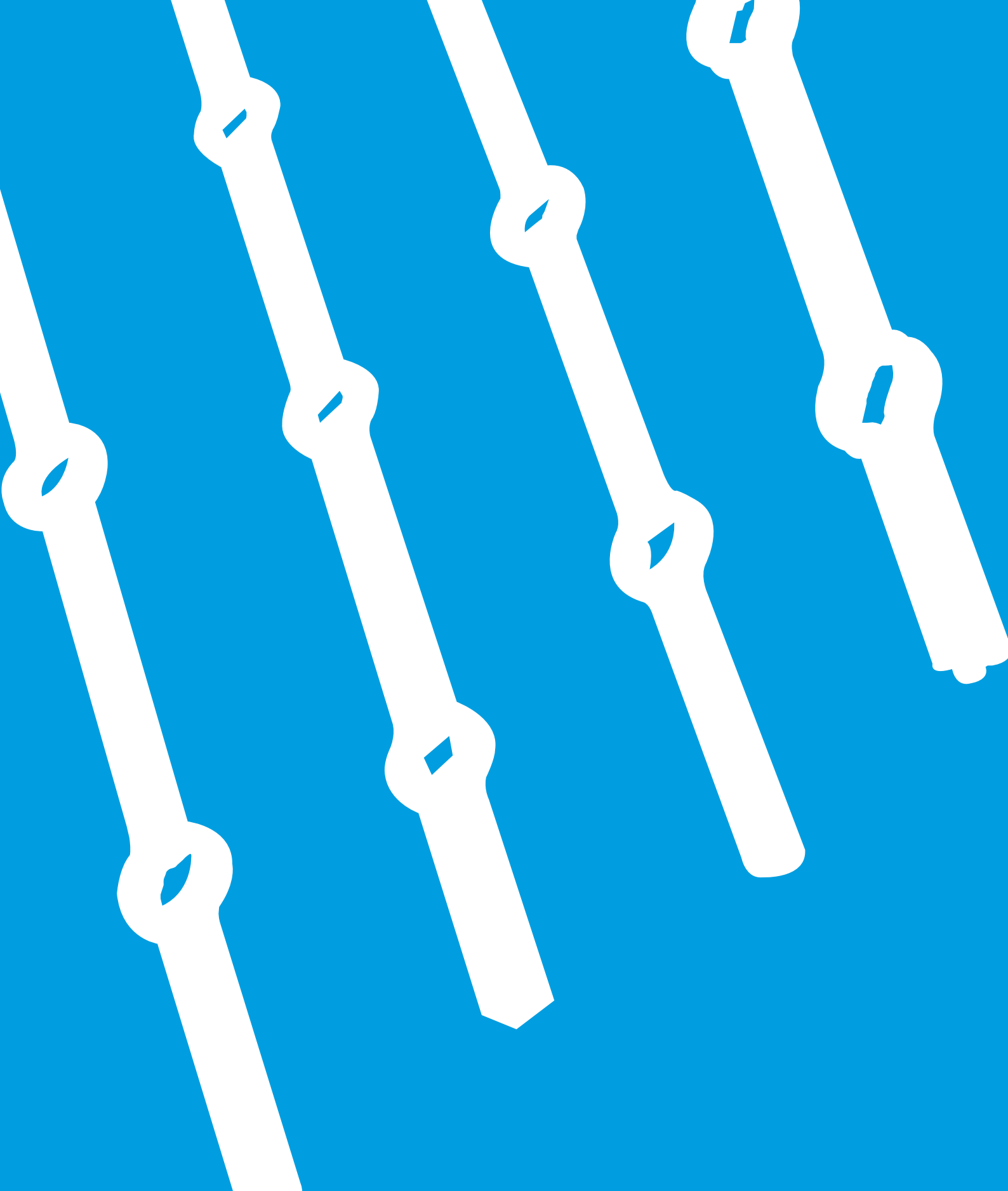

BARRE FORATE - PIERCED BARS

COMPENDIUM 2011

Art. 1361/5
Art. 1360/6
Art. 42/8
Art. 42/1

BARRE FORATE A CALDO - HOT PIERCED BARS



Sezione Section	Cod.art. Art.no.	Interasse Pitch	Foro Hole	Luce Distance	Numero Fori Holes Number
Ø 12 mm	1360/6	120 mm	Ø 12 mm	108 mm	16
Ø 14 mm	42/1	140 mm	Ø 14 mm	126 mm	14
	42/A/1	124 mm	Ø 14 mm	110 mm	14
Ø 16 mm	42/2	150 mm	Ø 16 mm	134 mm	13
	42/A/2	126 mm	Ø 16 mm	110 mm	14
Ø 18 mm	42/3	160 mm	Ø 18 mm	142 mm	12
	42/A/3	128 mm	Ø 18 mm	110 mm	14
Ø 20 mm	42/4	170 mm	Ø 20 mm	150 mm	11
	42/A/4	130 mm	Ø 20 mm	110 mm	14
Ø 22 mm	42/5	170 mm	Ø 22 mm	148 mm	11
Ø 25 mm	42/6	180 mm	Ø 25 mm	155 mm	10
Ø 30 mm	42/7	200 mm	Ø 30 mm	170 mm	9



Sezione Section	Cod.art. Art.no.	Interasse Pitch	Foro Hole	Luce Distance	Numero Fori Holes Number
Ø 14 mm	606/1	140 mm	Ø 14 mm	126 mm	14
Ø 16 mm	606/2	150 mm	Ø 16 mm	134 mm	13
Ø 18 mm	606/3	160 mm	Ø 18 mm	142 mm	12
Ø 20 mm	606/4	170 mm	Ø 20 mm	150 mm	11

Cod.art. Art.no.	Da abbinare con To couple with
606/1	598/14
606/2	598/15
606/3	598/16
606/4	598/17



Sezione Section	Cod.art. Art.no.	Interasse Pitch	Foro Hole	Luce Distance	Numero Fori Holes Number
Ø 14 mm	607/1	140 mm	Ø 28 x 14 mm	126 mm	14
Ø 16 mm	607/2	150 mm	Ø 32 x 16 mm	134 mm	13
Ø 18 mm	607/3	160 mm	Ø 34 x 18 mm	142 mm	12
Ø 20 mm	607/4	170 mm	Ø 38 x 20 mm	150 mm	11

BARRE FORATE A CALDO - HOT PIERCED BARS

L 2000 mm

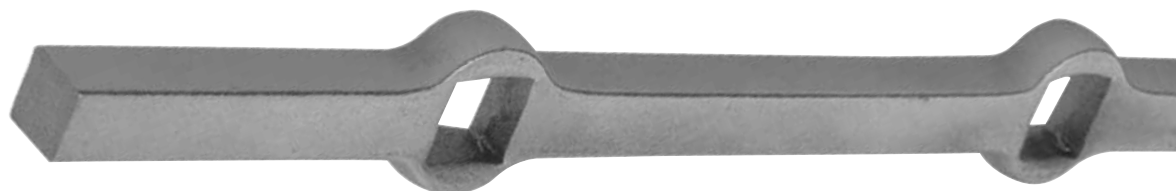

Sezione Section	Cod.art. Art.no.	Interasse Pitch	Foro Hole	Luce Distance	Numero Fori Holes Number
Φ 12 x 12 mm	1360/7	120 mm	Φ 12 x 12 mm	108 mm	16
Φ 14 x 14 mm	42/8	140 mm	Φ 14 x 14 mm	126 mm	14
	42/A/5	124 mm	Φ 14 x 14 mm	110 mm	14
Φ 16 x 16 mm	42/9	150 mm	Φ 16 x 16 mm	134 mm	13
	42/A/6	126 mm	Φ 16 x 16 mm	110 mm	14
Φ 18 x 18 mm	42/10	160 mm	Φ 18 x 18 mm	142 mm	12
	42/A/7	128 mm	Φ 18 x 18 mm	110 mm	14
	42/A/17	122 mm	Φ 12 x 12 mm	110 mm	14
	42/A/18	124 mm	Φ 14 x 14 mm	110 mm	14
Φ 20 x 20 mm	42/11	170 mm	Φ 20 x 20 mm	150 mm	11
	42/A/8	130 mm	Φ 20 x 20 mm	110 mm	14
Φ 22 x 22 mm	42/12	170 mm	Φ 22 x 22 mm	148 mm	11
Φ 25 x 25 mm	42/13	180 mm	Φ 25 x 25 mm	165 mm	10
Φ 30 x 30 mm	42/14	220 mm	Φ 30 x 30 mm	190 mm	9

L 2000 mm

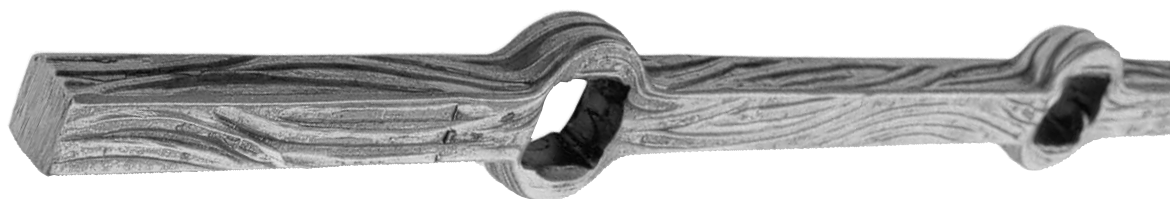

Sezione Section	Cod.art. Art.no.	Interasse Pitch	Foro Hole	Luce Distance	Numero Fori Holes Number
Φ 14 x 14 mm	605/1	140 mm	Φ 14 x 14 mm	126 mm	14
Φ 16 x 16 mm	605/2	150 mm	Φ 16 x 16 mm	134 mm	13
Φ 18 x 18 mm	605/3	160 mm	Φ 18 x 18 mm	142 mm	12
Φ 20 x 20 mm	605/4	170 mm	Φ 20 x 20 mm	150 mm	11

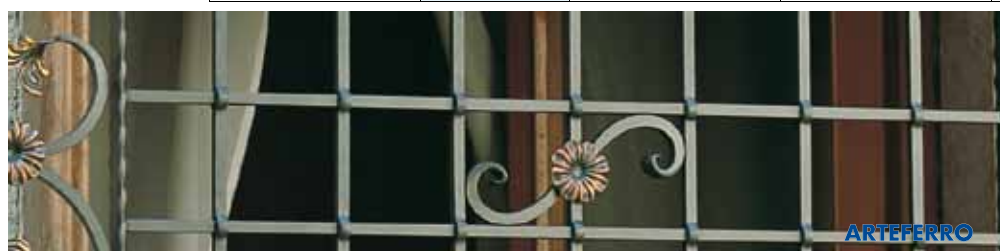

Cod.art. Art.no.	Da abbinare con To couple with
605/1	623/6
605/2	623/7
605/3	623/8
605/4	623/9

L 2000 mm



Sezione Section	Cod.art. Art.no.	Interasse Pitch	Foro Hole	Luce Distance	Numero Fori Holes Number
Φ 14 x 14 mm	1845/20	140 mm	∇ 24 x 15 mm		11
Φ 16 x 16 mm	1845/21	150 mm	∇ 30 x 17 mm		10
Φ 18 x 18 mm	1845/22	160 mm	∇ 31 x 19 mm		10
Φ 20 x 20 mm	1845/23	170 mm	∇ 33 x 21 mm		9



L 2000 mm

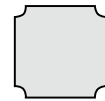

Sezione Section	Cod.art. Art.no.	Interasse Pitch	Foro Hole	Luce Distance	Numero Fori Holes Number
Φ 12 x 12 mm	I360/1	120 mm	Φ 12 x 12 mm	108 mm	16
Φ 14 x 14 mm	I360/2	140 mm	Φ 14 x 14 mm	126 mm	14
Φ 16 x 16 mm	I360/3	150 mm	Φ 16 x 16 mm	134 mm	13
Φ 18 x 18 mm	I360/4	160 mm	Φ 18 x 18 mm	142 mm	12
Φ 20 x 20 mm	I360/5	170 mm	Φ 20 x 20 mm	150 mm	11

Cod.art. Art.no.	Da abbinare con To couple with
I360/1	118/1
I360/2	118/2
I360/3	118/4
I360/4	118/5
I360/5	118/6



L 2000 mm

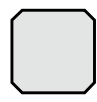

Sezione Section	Cod.art. Art.no.	Interasse Pitch	Foro Hole	Luce Distance	Numero Fori Holes Number
Φ 12 x 12 mm	GD124/9	120 mm	Φ 12 x 12 mm	108 mm	16
Φ 14 x 14 mm	GD124/10	140 mm	Φ 14 x 14 mm	126 mm	14
Φ 16 x 16 mm	GD124/11	150 mm	Φ 16 x 16 mm	134 mm	13
Φ 18 x 18 mm	GD124/12	160 mm	Φ 18 x 18 mm	142 mm	12
Φ 20 x 20 mm	GD124/13	170 mm	Φ 20 x 20 mm	150 mm	11
Φ 22 x 22 mm	GD124/14	170 mm	Φ 22 x 22 mm	148 mm	11
Φ 25 x 25 mm	GD124/15	180 mm	Φ 25 x 25 mm	155 mm	10
Φ 30 x 30 mm	GD124/16	200 mm	Φ 30 x 30 mm	170 mm	9

Cod.art. Art.no.	Da abbinare con To couple with	Da abbinare con To couple with	Da abbinare con To couple with
	L 2000 mm	L 3000 mm	L 6000 mm
GD124/9	118/A/44	GD124/17	GD124/25
GD124/10	118/A/17	GD124/18	GD124/26
GD124/11	118/A/18	GD124/19	GD124/27
GD124/12	118/A/19	GD124/20	GD124/28
GD124/13	118/A/20	GD124/21	GD124/29
GD124/14	118/A/21	GD124/22	GD124/30
GD124/15	118/A/22	GD124/23	GD124/31
GD124/16	118/A/23	GD124/24	GD124/32



L 2000 mm

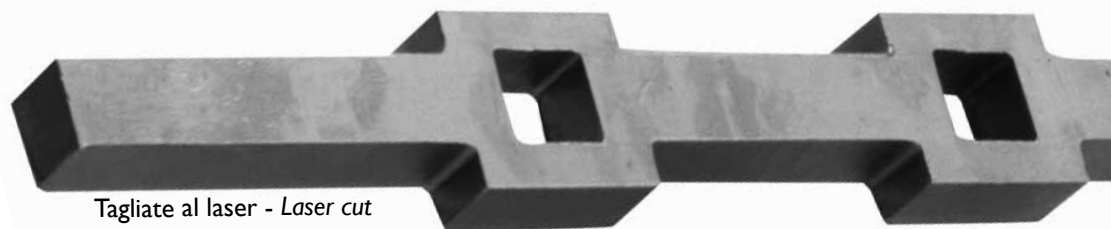

Tagliate al laser - Laser cut

Sezione Section	Cod.art. Art.no.	Interasse Pitch	Foro Hole	Luce Distance	Numero Fori Holes Number
Φ 14 x 14 mm	1845/6	125 mm	Φ 15 x 15 mm	110 mm	15
Φ 14 x 14 mm	1845/7	145 mm	Φ 15 x 15 mm	130 mm	12
Φ 16 x 16 mm	1845/8	127 mm	Φ 17 x 17 mm	110 mm	15
Φ 16 x 16 mm	1845/9	147 mm	Φ 17 x 17 mm	130 mm	12
Φ 25 x 25 mm	1845/10	136 mm	Φ 26 x 26 mm	110 mm	14



ARTEFERRO

L 2000 mm



Sezione Section	Cod.art. Art.no.	Interasse Pitch	Foro Hole	Luce Distance	Numero Fori Holes Number
Φ 12 x 12 mm	1361/5	140 mm	Φ 12 x 12 mm		14
Φ 14 x 14 mm	1361/6	150 mm	Φ 14 x 14 mm		13
Φ 15 x 15 mm	1361/7	160 mm	Φ 15 x 15 mm		12
Φ 17 x 17 mm	1361/8	170 mm	Φ 17 x 17 mm		11



Sezione Section	Da abbinare con To couple with
Φ 12 x 12 mm	626/10
Φ 14 x 14 mm	626/11
Φ 15 x 15 mm	626/12
Φ 17 x 17 mm	626/13

L 2000 mm



Sezione Section	Cod.art. Art.no.	Interasse Pitch	Foro Hole	Luce Distance	Numero Fori Holes Number
Φ 12 x 12 mm	1361/1	140 mm	Φ 12 x 12 mm		14
Φ 14 x 14 mm	1361/2	150 mm	Φ 14 x 14 mm		13
Φ 15 x 15 mm	1361/3	160 mm	Φ 15 x 15 mm		12
Φ 17 x 17 mm	1361/4	170 mm	Φ 17 x 17 mm		11

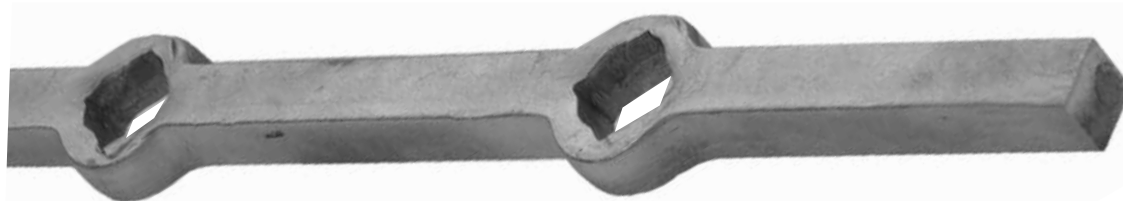

L 2000 mm



Sezione Section	Cod.art. Art.no.	Interasse Pitch	Foro Hole	Luce Distance	Numero Fori Holes Number
Φ 14 x 14 mm	42/22	140 mm	Φ 14 x 14 mm		14
	42/A/13	124 mm	Φ 14 x 14 mm		14
Φ 16 x 16 mm	42/23	150 mm	Φ 16 x 16 mm		13
	42/A/14	126 mm	Φ 16 x 16 mm		14
Φ 18 x 18 mm	42/24	160 mm	Φ 18 x 18 mm		12
	42/A/15	128 mm	Φ 18 x 18 mm		14
Φ 20 x 20 mm	42/25	170 mm	Φ 20 x 20 mm		11
	42/A/16	130 mm	Φ 20 x 20 mm		14
Φ 22 x 22 mm	42/26	170 mm	Φ 22 x 22 mm		11
Φ 25 x 25 mm	42/27	180 mm	Φ 25 x 25 mm		10
Φ 30 x 30 mm	42/28	200 mm	Φ 30 x 30 mm		9

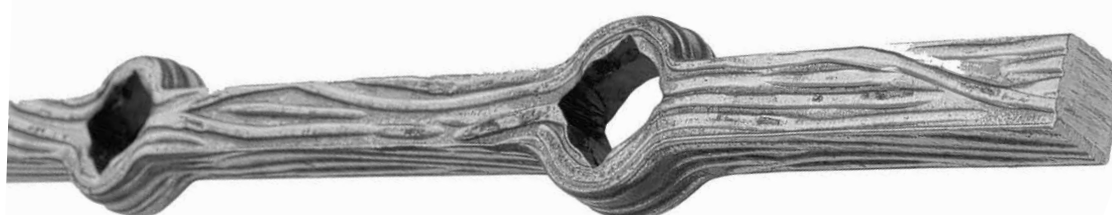

L 2000 mm



Sezione Section	Cod.art. Art.no.	Interasse Pitch	Foro Hole	Luce Distance	Numero Fori Holes Number
Φ 14 x 14 mm	605/5	140 mm	Φ 14 x 14 mm		14
Φ 16 x 16 mm	605/6	150 mm	Φ 16 x 16 mm		13
Φ 18 x 18 mm	605/7	160 mm	Φ 18 x 18 mm		12
Φ 20 x 20 mm	605/8	170 mm	Φ 20 x 20 mm		11



ARTEFERRO

L 2000 mm



Tagliate al laser - Laser cut

Sezione Section	Cod.art. Art.no.	Interasse Pitch	Foro Hole	Luce Distance	Numero Fori Holes Number
Φ 14 × 14 mm	1845/1		Φ 15 × 15 mm	110 mm	14
Φ 14 × 14 mm	1845/2		Φ 15 × 15 mm	130 mm	13
Φ 16 × 16 mm	1845/3		Φ 17 × 17 mm	110 mm	12
Φ 16 × 16 mm	1845/4		Φ 17 × 17 mm	130 mm	11
Φ 25 × 25 mm	1845/5		Φ 26 × 26 mm	110 mm	14

L 2000 mm



Sezione Section	Cod.art. Art.no.	Interasse Pitch	Foro Hole	Luce Distance	Numero Fori Holes Number
Φ 14 × 14 mm	42/15	140 mm	Φ 14 × 14 mm		14
	42/A/9	124 mm	Φ 14 × 14 mm	110 mm	14
Φ 16 × 16 mm	42/16	150 mm	Φ 16 × 16 mm		13
	42/A/10	126 mm	Φ 16 × 16 mm	110 mm	14
Φ 18 × 18 mm	42/17	160 mm	Φ 18 × 18 mm		12
	42/A/11	128 mm	Φ 18 × 18 mm	110 mm	14
Φ 20 × 20 mm	42/18	170 mm	Φ 20 × 20 mm		11
	42/A/12	130 mm	Φ 20 × 20 mm	110 mm	14
Φ 22 × 22 mm	42/19	170 mm	Φ 22 × 22 mm		11
Φ 25 × 25 mm	42/20	180 mm	Φ 25 × 25 mm		10
Φ 30 × 30 mm	42/21	200 mm	Φ 30 × 30 mm		9

L 2000 mm



Sezione Section	Cod.art. Art.no.	Interasse Pitch	Foro Hole	Luce Distance	Numero Fori Holes Number
Φ 14 × 14 mm	1845/16		∇ 18 × 15 mm	140 mm	11
Φ 16 × 16 mm	1845/17		∇ 32 × 17 mm	150 mm	10
Φ 18 × 18 mm	1845/18		∇ 34 × 19 mm	160 mm	9
Φ 20 × 20 mm	1845/19		∇ 38 × 21 mm	170 mm	9



L 2000 mm



Sezione Section	Cod.art. Art.no.	Interasse Pitch	Foro Hole	Luce Distance	Numero Fori Holes Number
Φ 14 x 14 mm	I845/24	155 mm	Ø 15 mm	140 mm	11
Φ 16 x 16 mm	I845/25	167 mm	Ø 17 mm	150 mm	10
Φ 18 x 18 mm	I845/26	179 mm	Ø 19 mm	160 mm	9
Φ 20 x 20 mm	I845/27	191 mm	Ø 21 mm	170 mm	9

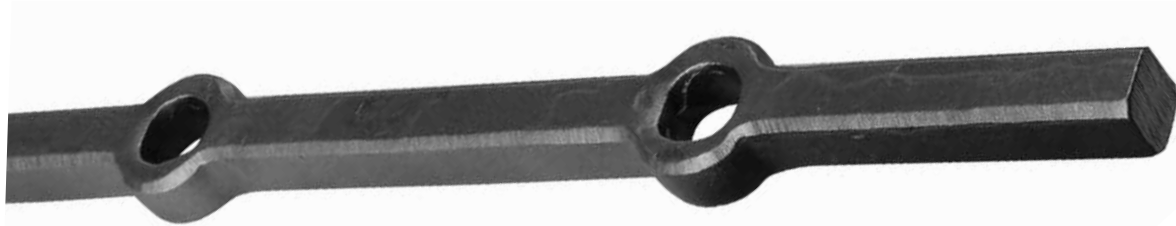

L 2000 mm



Sezione Section	Cod.art. Art.no.	Interasse Pitch	Foro Hole	Luce Distance	Numero Fori Holes Number
Φ 12 x 12 mm	GD124/1	120 mm	Ø 12 mm	108 mm	16
Φ 14 x 14 mm	GD124/2	140 mm	Ø 14 mm	126 mm	14
Φ 16 x 16 mm	GD124/3	150 mm	Ø 16 mm	134 mm	13
Φ 18 x 18 mm	GD124/4	160 mm	Ø 18 mm	142 mm	12
Φ 20 x 20 mm	GD124/5	170 mm	Ø 20 mm	150 mm	11
Φ 22 x 22 mm	GD124/6	170 mm	Ø 22 mm	148 mm	11
Φ 25 x 25 mm	GD124/7	180 mm	Ø 25 mm	155 mm	10
Φ 30 x 30 mm	GD124/8	200 mm	Ø 30 mm	170 mm	9



L 2000 mm



Tagliate al laser - Laser cut

Sezione Section	Cod.art. Art.no.	Interasse Pitch	Foro Hole	Luce Distance	Numero Fori Holes Number
Φ 14 x 14 mm	I845/11	95 mm	Ø 15 mm	110 mm	15
Φ 14 x 14 mm	I845/12	115 mm	Ø 15 mm	130 mm	12
Φ 16 x 16 mm	I845/13	93 mm	Ø 17 mm	110 mm	15
Φ 16 x 16 mm	I845/14	113 mm	Ø 17 mm	130 mm	12
Φ 25 x 25 mm	I845/15	116 mm	Ø 26 mm	110 mm	14

L 2000 mm
circa-approx.



A RICHIESTA
Disponibili qualsiasi lunghezza,
foro e sezione
UPON REQUEST
Available in any length, hole and section

Sezione Section	Foro Hole	Interasse Pitch	Luce Distance	Cod.art./Art.no.	Numero Fori Holes number	Lunghezza Length
☒ 30 x 8 mm	Ø 13 mm	112 mm	100 mm	1853/105	17	2004 mm
		127 mm	115 mm	1853/106	15	2020 mm
		142 mm	130 mm	1853/107	13	1976 mm
	Ø 15 mm	114 mm	100 mm	1853/108	16	1924 mm
		129 mm	115 mm	1853/109	14	1921 mm
		144 mm	130 mm	1853/110	13	2002 mm
	Ø 17 mm	116 mm	100 mm	1853/111	16	1956 mm
		131 mm	115 mm	1853/112	14	1949 mm
		146 mm	130 mm	1853/113	13	2028 mm
☒ 30 x 10 mm	Ø 13 mm	112 mm	100 mm	1853/114	17	2004 mm
		127 mm	115 mm	1853/115	15	2020 mm
		142 mm	130 mm	1853/116	13	1976 mm
	Ø 15 mm	114 mm	100 mm	1853/117	16	1924 mm
		129 mm	115 mm	1853/118	14	1921 mm
		144 mm	130 mm	1853/119	13	2002 mm
	Ø 17 mm	116 mm	100 mm	1853/120	16	1956 mm
		131 mm	115 mm	1853/121	14	1949 mm
		146 mm	130 mm	1853/122	13	2028 mm
☒ 35 x 8 mm	Ø 13 mm	112 mm	100 mm	1853/123	17	2004 mm
		127 mm	115 mm	1853/124	15	2020 mm
		142 mm	130 mm	1853/125	13	1976 mm
	Ø 15 mm	114 mm	100 mm	1853/126	16	1924 mm
		129 mm	115 mm	1853/127	14	1921 mm
		144 mm	130 mm	1853/128	13	2002 mm
	Ø 17 mm	116 mm	100 mm	1853/129	16	1956 mm
		131 mm	115 mm	1853/130	14	1949 mm
		146 mm	130 mm	1853/131	13	2028 mm
☒ 35 x 10 mm	Ø 13 mm	112 mm	100 mm	1853/132	17	2004 mm
		127 mm	115 mm	1853/133	15	2020 mm
		142 mm	130 mm	1853/134	13	1976 mm
	Ø 15 mm	114 mm	100 mm	1853/135	16	1924 mm
		129 mm	115 mm	1853/136	14	1921 mm
		144 mm	130 mm	1853/137	13	2002 mm
	Ø 17 mm	116 mm	100 mm	1853/138	16	1956 mm
		131 mm	115 mm	1853/139	14	1949 mm
		146 mm	130 mm	1853/140	13	2028 mm
☒ 40 x 8 mm	Ø 13 mm	112 mm	100 mm	1853/141	17	2004 mm
		127 mm	115 mm	1853/142	15	2020 mm
		142 mm	130 mm	1853/143	13	1976 mm
	Ø 15 mm	114 mm	100 mm	1853/144	16	1924 mm
		129 mm	115 mm	1853/145	14	1921 mm
		144 mm	130 mm	1853/146	13	2002 mm
	Ø 17 mm	116 mm	100 mm	1853/147	16	1956 mm
		131 mm	115 mm	1853/148	14	1949 mm
		146 mm	130 mm	1853/149	13	2028 mm
☒ 40 x 10 mm	Ø 13 mm	112 mm	100 mm	1853/150	17	2004 mm
		127 mm	115 mm	1853/151	15	2020 mm
		142 mm	130 mm	1853/152	13	1976 mm
	Ø 15 mm	114 mm	100 mm	1853/153	16	1924 mm
		129 mm	115 mm	1853/154	14	1921 mm
		144 mm	130 mm	1853/155	13	2002 mm
	Ø 17 mm	116 mm	100 mm	1853/156	16	1956 mm
		131 mm	115 mm	1853/157	14	1949 mm
		146 mm	130 mm	1853/158	13	2028 mm

L 2000 mm
circa-*approx.*



A RICHIESTA
Disponibili qualsiasi lunghezza,
foro e sezione
UPON REQUEST
Available in any length, hole and section

Sezione Section	Foro Hole	Interasse Pitch	Luce Distance	Cod.art./Art.no.	Numero Fori Holes number	Lunghezza Length
30 x 8 mm	13 x 13 mm	112 mm	100 mm	1853/1	17	2004 mm
		127 mm	115 mm	1853/2	15	2020 mm
		142 mm	130 mm	1853/3	13	1976 mm
	15 x 15 mm	114 mm	100 mm	608/6	16	1924 mm
		129 mm	115 mm	1853/4	14	1921 mm
		144 mm	130 mm	608/5	13	2002 mm
	17 x 17 mm	116 mm	100 mm	1853/5	16	1956 mm
		131 mm	115 mm	1853/6	14	1949 mm
		146 mm	130 mm	1853/7	13	2028 mm
30 x 10 mm	13 x 13 mm	112 mm	100 mm	1853/8	17	2004 mm
		127 mm	115 mm	1853/9	15	2020 mm
		142 mm	130 mm	1853/10	13	1976 mm
	15 x 15 mm	114 mm	100 mm	1853/11	16	1924 mm
		129 mm	115 mm	1853/12	14	1921 mm
		144 mm	130 mm	1853/13	13	2002 mm
	17 x 17 mm	116 mm	100 mm	1853/14	16	1956 mm
		131 mm	115 mm	1853/15	14	1949 mm
		146 mm	130 mm	1853/16	13	2028 mm
35 x 8 mm	13 x 13 mm	112 mm	100 mm	1853/17	17	2004 mm
		127 mm	115 mm	1853/18	15	2020 mm
		142 mm	130 mm	1853/19	13	1976 mm
	15 x 15 mm	114 mm	100 mm	1853/20	16	1924 mm
		129 mm	115 mm	1853/21	14	1921 mm
		144 mm	130 mm	1853/22	13	2002 mm
	17 x 17 mm	116 mm	100 mm	1853/23	16	1956 mm
		131 mm	115 mm	1853/24	14	1949 mm
		146 mm	130 mm	1853/25	13	2028 mm
35 x 10 mm	13 x 13 mm	112 mm	100 mm	1853/26	17	2004 mm
		127 mm	115 mm	1853/27	15	2020 mm
		142 mm	130 mm	1853/28	13	1976 mm
	15 x 15 mm	114 mm	100 mm	1853/29	16	1924 mm
		129 mm	115 mm	1853/30	14	1921 mm
		144 mm	130 mm	1853/31	13	2002 mm
	17 x 17 mm	116 mm	100 mm	1853/32	16	1956 mm
		131 mm	115 mm	1853/33	14	1949 mm
		146 mm	130 mm	1853/34	13	2028 mm
40 x 8 mm	13 x 13 mm	112 mm	100 mm	1853/35	17	2004 mm
		127 mm	115 mm	1853/36	15	2020 mm
		142 mm	130 mm	1853/37	13	1976 mm
	15 x 15 mm	114 mm	100 mm	608/8	16	1924 mm
		129 mm	115 mm	1853/38	14	1921 mm
		144 mm	130 mm	608/7	13	2002 mm
	17 x 17 mm	116 mm	100 mm	1853/39	16	1956 mm
		132 mm	115 mm	1853/40	14	1949 mm
		146 mm	130 mm	1853/41	13	2028 mm
40 x 10 mm	13 x 13 mm	112 mm	100 mm	1853/42	17	2004 mm
		127 mm	115 mm	1853/43	15	2020 mm
		142 mm	130 mm	1853/44	13	1976 mm
	15 x 15 mm	114 mm	100 mm	1853/45	16	1924 mm
		129 mm	115 mm	1853/46	14	1921 mm
		144 mm	130 mm	1853/47	13	2002 mm
	17 x 17 mm	116 mm	100 mm	1853/48	16	1956 mm
		131 mm	115 mm	1853/49	14	1949 mm
		146 mm	130 mm	1853/50	13	2028 mm

A RICHIESTA
Disponibili qualsiasi lunghezza,
foro e sezione
UPON REQUEST
Available in any length, hole and section

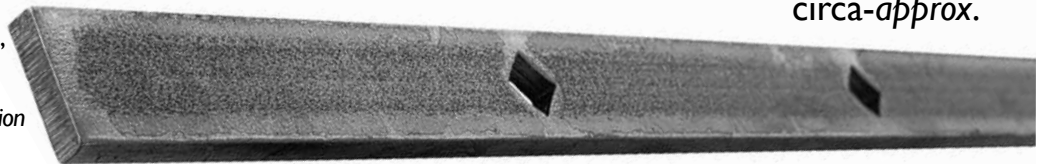





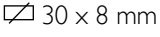

Sezione Section	Foro Hole	Interasse Pitch	Luce Distance	Cod.art./Art.no.	Numero Fori Holes number
30 x 8 mm	13 x 13 mm	112 mm	100 mm	1853/51	16
		127 mm	115 mm	1853/52	14
		142 mm	130 mm	1853/53	13
	15 x 15 mm	114 mm	100 mm	1853/54	16
		129 mm	115 mm	1853/55	14
		144 mm	130 mm	1853/56	12
	17 x 17 mm	116 mm	100 mm	1853/57	16
		131 mm	115 mm	1853/58	14
		146 mm	130 mm	1853/59	12
30 x 10 mm	13 x 13 mm	112 mm	100 mm	1853/60	16
		127 mm	115 mm	1853/61	14
		142 mm	130 mm	1853/62	13
	15 x 15 mm	114 mm	100 mm	1853/63	16
		129 mm	115 mm	1853/64	14
		144 mm	130 mm	1853/65	12
	17 x 17 mm	116 mm	100 mm	1853/66	16
		132 mm	115 mm	1853/67	14
		146 mm	130 mm	1853/68	12
35 x 8 mm	13 x 13 mm	112 mm	100 mm	1853/69	16
		127 mm	115 mm	1853/70	14
		142 mm	130 mm	1853/71	13
	15 x 15 mm	114 mm	100 mm	1853/72	16
		129 mm	115 mm	1853/73	14
		144 mm	130 mm	1853/74	12
	17 x 17 mm	116 mm	100 mm	1853/75	16
		131 mm	115 mm	1853/76	14
		146 mm	130 mm	1853/77	12
35 x 10 mm	13 x 13 mm	112 mm	100 mm	1853/78	16
		127 mm	115 mm	1853/79	14
		142 mm	130 mm	1853/80	13
	15 x 15 mm	114 mm	100 mm	1853/81	16
		129 mm	115 mm	1853/82	14
		144 mm	130 mm	1853/83	12
	17 x 17 mm	116 mm	100 mm	1853/84	16
		131 mm	115 mm	1853/85	14
		146 mm	130 mm	1853/86	12
40 x 8 mm	13 x 13 mm	112 mm	100 mm	1853/87	16
		127 mm	115 mm	1853/88	14
		142 mm	130 mm	1853/89	13
	15 x 15 mm	114 mm	100 mm	1853/90	16
		129 mm	115 mm	1853/91	14
		144 mm	130 mm	1853/92	12
	17 x 17 mm	116 mm	100 mm	1853/93	16
		131 mm	115 mm	1853/94	14
		146 mm	130 mm	1853/95	12
40 x 10 mm	13 x 13 mm	112 mm	100 mm	1853/96	16
		127 mm	115 mm	1853/97	14
		142 mm	130 mm	1853/98	13
	15 x 15 mm	114 mm	100 mm	1853/99	16
		129 mm	115 mm	1853/100	14
		144 mm	130 mm	1853/101	12
	17 x 17 mm	116 mm	100 mm	1853/102	16
		132 mm	115 mm	1853/103	14
		146 mm	130 mm	1853/104	12

L 2000 mm
circa-*approx.*

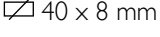

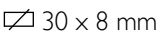
A RICHIESTA
Disponibili qualsiasi lunghezza,
foro e sezione
UPON REQUEST
Available in any length, hole and section

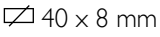
Sezione Section	Foro Hole	Interasse Pitch	Luce Distance	Cod.art./Art.no.	Numero Fori Holes number	Lunghezza Lenght
 FORO HOLE  30 x 8 mm	Φ 13 x 13 mm	112 mm	100 mm	1853/159	17	2004 mm
		127 mm	115 mm	1853/160	15	2020 mm
		142 mm	130 mm	1853/161	13	1976 mm
	Φ 15 x 15 mm	114 mm	100 mm	1853/162	16	1924 mm
		129 mm	115 mm	1853/163	14	1921 mm
		147 mm	130 mm	1853/164	13	2002 mm
	Φ 17 x 17 mm	116 mm	100 mm	1853/165	16	1956 mm
		131 mm	115 mm	1853/166	14	1949 mm
		146 mm	130 mm	1853/167	13	2028 mm
 FORO HOLE  40 x 8 mm	Φ 13 x 13 mm	112 mm	100 mm	1853/168	17	2004 mm
		127 mm	115 mm	1853/169	15	2020 mm
		142 mm	130 mm	1853/170	13	1976 mm
	Φ 15 x 15 mm	114 mm	100 mm	1853/171	16	1924 mm
		129 mm	115 mm	1853/172	14	1921 mm
		147 mm	130 mm	1853/173	13	2002 mm
	Φ 17 x 17 mm	116 mm	100 mm	1853/174	16	1956 mm
		131 mm	115 mm	1853/175	14	1949 mm
		146 mm	130 mm	1853/176	13	2028 mm
 FORO HOLE  30 x 8 mm	Φ 13 x 13 mm	112 mm	100 mm	1853/177	17	2004 mm
		127 mm	115 mm	1853/178	15	2020 mm
		142 mm	130 mm	1853/179	13	1976 mm
	Φ 15 x 15 mm	114 mm	100 mm	1853/180	16	1924 mm
		129 mm	115 mm	1853/181	14	1921 mm
		147 mm	130 mm	1853/182	13	2002 mm
	Φ 17 x 17 mm	116 mm	100 mm	1853/183	16	1956 mm
		131 mm	115 mm	1853/184	14	1949 mm
		146 mm	130 mm	1853/185	13	2028 mm
 FORO HOLE  40 x 8 mm	Φ 13 x 13 mm	112 mm	100 mm	1853/186	17	2004 mm
		127 mm	115 mm	1853/187	15	2020 mm
		142 mm	130 mm	1853/188	13	1976 mm
	Φ 15 x 15 mm	114 mm	100 mm	1853/189	16	1924 mm
		129 mm	115 mm	1853/190	14	1921 mm
		147 mm	130 mm	1853/191	13	2002 mm
	Φ 17 x 17 mm	116 mm	100 mm	1853/192	16	1956 mm
		131 mm	115 mm	1853/193	14	1949 mm
		146 mm	130 mm	1853/194	13	2028 mm



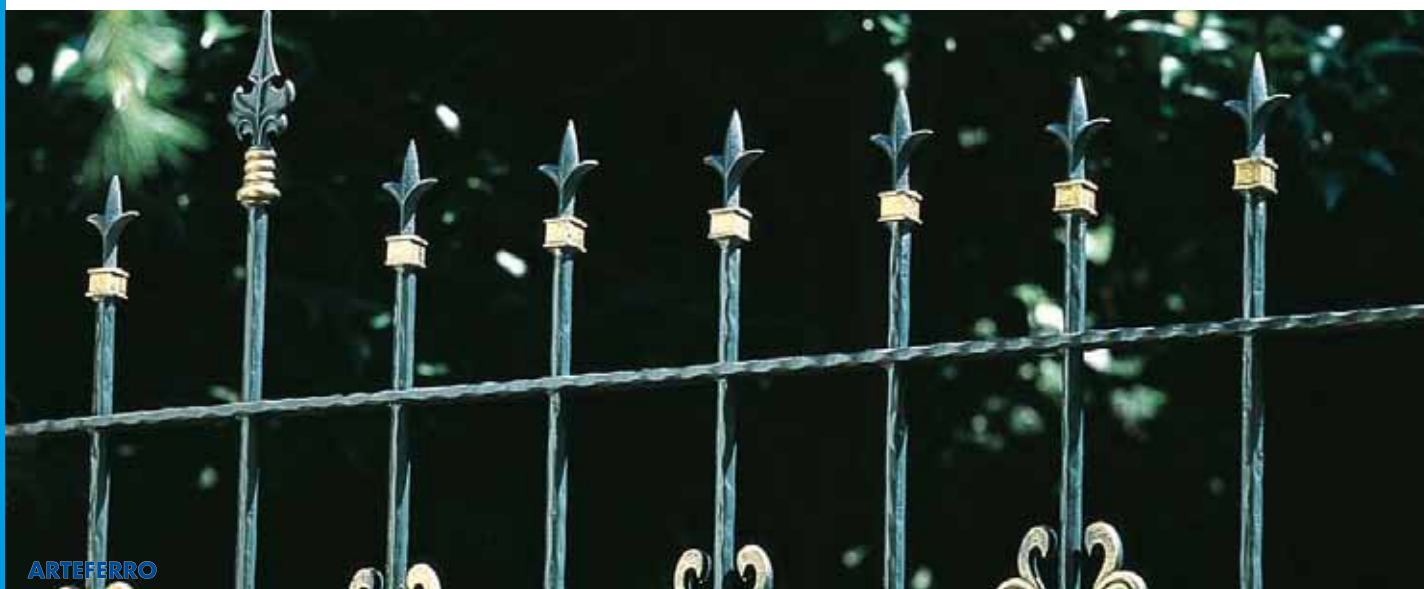



BARRE FORATE - PIERCED BARS

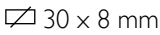

ARTEFERRO

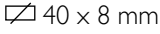
A RICHIESTA
Disponibili qualsiasi lunghezza,
foro e sezione
UPON REQUEST
Available in any length, hole and section

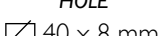

Sezione Section	Foro Hole	Interasse Pitch	Luce Distance	Cod.art./Art.no.	Numero Fori Holes number	Lunghezza Length
 FORO HOLE  30 x 8 mm	Φ 13 x 13 mm	112 mm	100 mm	1853/195	17	2004 mm
		127 mm	115 mm	1853/196	15	2020 mm
		142 mm	130 mm	1853/197	13	1976 mm
	Φ 15 x 15 mm	114 mm	100 mm	1853/198	16	1924 mm
		129 mm	115 mm	1853/199	14	1921 mm
		147 mm	130 mm	1853/200	13	2002 mm
	Φ 17 x 17 mm	116 mm	100 mm	1853/201	16	1956 mm
		131 mm	115 mm	1853/202	14	1949 mm
		146 mm	130 mm	1853/203	13	2028 mm
 FORO HOLE  40 x 8 mm	Φ 13 x 13 mm	112 mm	100 mm	1853/204	17	2004 mm
		127 mm	115 mm	1853/205	15	2020 mm
		142 mm	130 mm	1853/206	13	1976 mm
	Φ 15 x 15 mm	114 mm	100 mm	1853/207	16	1924 mm
		129 mm	115 mm	1853/208	14	1921 mm
		147 mm	130 mm	1853/209	13	2002 mm
	Φ 17 x 17 mm	116 mm	100 mm	1853/210	16	1956 mm
		131 mm	115 mm	1853/211	14	1949 mm
		146 mm	130 mm	1853/212	13	2028 mm
 FORO HOLE  30 x 8 mm	Φ 13 x 13 mm	112 mm	100 mm	1853/213	17	2004 mm
		127 mm	115 mm	1853/214	15	2020 mm
		142 mm	130 mm	1853/215	13	1976 mm
	Φ 15 x 15 mm	114 mm	100 mm	1853/216	16	1924 mm
		129 mm	115 mm	1853/217	14	1921 mm
		147 mm	130 mm	1853/218	13	2002 mm
	Φ 17 x 17 mm	116 mm	100 mm	1853/219	16	1956 mm
		131 mm	115 mm	1853/220	14	1949 mm
		146 mm	130 mm	1853/221	13	2028 mm
 FORO HOLE  40 x 8 mm	Φ 13 x 13 mm	112 mm	100 mm	1853/222	17	2004 mm
		127 mm	115 mm	1853/223	15	2020 mm
		142 mm	130 mm	1853/224	13	1976 mm
	Φ 15 x 15 mm	114 mm	100 mm	1853/225	16	1924 mm
		129 mm	115 mm	1853/226	14	1921 mm
		147 mm	130 mm	1853/227	13	2002 mm
	Φ 17 x 17 mm	116 mm	100 mm	1853/228	16	1956 mm
		131 mm	115 mm	1853/229	14	1949 mm
		146 mm	130 mm	1853/230	13	2028 mm





L 2000 mm
circa-*approx.*

Sezione Section	Foro Hole	Interasse Pitch	Luce Distance	Cod.art./Art.no.	Numero Fori Holes Number
30 x 15 mm	18 x 18 mm	140 mm	122 mm	1360/10	14
30 x 20 mm	18 x 18 mm	140 mm	122 mm	1360/11	14



L 2000 mm
circa-*approx.*

Sezione Section	Foro Hole	Interasse Pitch	Luce Distance	Cod.art./Art.no.	Numero Fori Holes Number
30 x 15 mm	Ø 20 mm	140 mm	120 mm	1360/8	14
30 x 20 mm	Ø 20 mm	140 mm	120 mm	1360/9	14



L 2000 mm
circa-*approx.*

Sezione Section	Foro Hole	Interasse Pitch	Luce Distance	Cod.art./Art.no.	Numero Fori Holes Number
40 x 8 mm	15 x 15 mm		120 mm	1360/12	13
40 x 8 mm	17 x 17 mm		120 mm	1360/13	15

L 2000 mm
circa-*approx.*

Barre con ribattini stampati - Bars with stamped rivets



Sezione Section	Ribattino Rivet	Interasse Pitch 112 mm	Interasse Pitch 122 mm	Interasse Pitch 127 mm	Interasse Pitch 132 mm
		Cod.art./Art.no.	Cod.art./Art.no.	Cod.art./Art.no.	Cod.art./Art.no.
30 x 8 mm	Ø 11 mm	1852/1	1852/2	1852/3	1852/4
40 x 8 mm	Ø 16 mm	1852/5	1852/6	1852/7	1852/8

Barre con ribattini stampati - Bars with stamped rivets

L 2000 mm
circa-*approx.*



Sezione Section	Ribattino Rivet	Interasse Pitch 112 mm	Interasse Pitch 122 mm	Interasse Pitch 127 mm	Interasse Pitch 132 mm
		Cod.art./Art.no.	Cod.art./Art.no.	Cod.art./Art.no.	Cod.art./Art.no.
25 x 6 mm	Ø 16 mm	1852/9	1852/10	1852/11	1852/12
25 x 8 mm	Ø 16 mm	1852/13	1852/14	1852/15	1852/16
30 x 6 mm	Ø 16 mm	1852/17	1852/18	1852/19	1852/20

L 2000 mm
circa-*approx.*

Barre con ribattini stampati - Bars with stamped rivets



Sezione Section	Ribattino Rivet	Interasse Pitch 112 mm	Interasse Pitch 122 mm	Interasse Pitch 127 mm	Interasse Pitch 132 mm
		Cod.art./Art.no.	Cod.art./Art.no.	Cod.art./Art.no.	Cod.art./Art.no.
25 x 6 mm	Ø 16 mm	1852/25	1852/26	1852/27	1852/28
25 x 8 mm	Ø 16 mm	1852/29	1852/30	1852/31	1852/32
30 x 6 mm	Ø 16 mm	1852/33	1852/34	1852/35	1852/36
30 x 8 mm	Ø 16 mm	1852/37	1852/38	1852/39	1852/40



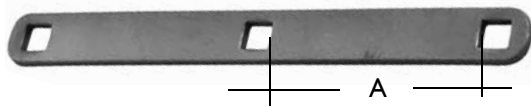

Cod.art./Art.no.	Sezione Section	Foro Hole	Luce A Distance A	Luce B Distance B	Lunghezza Length
GD128/49	25 x 6 mm	12 x 12 mm	100 mm	-	250 mm
GD128/57	25 x 6 mm	Ø 14 mm	100 mm	-	260 mm
GD128/53	30 x 6 mm	14 x 14 mm	100 mm	-	260 mm
GD128/61	30 x 6 mm	Ø 14 mm	100 mm	-	260 mm

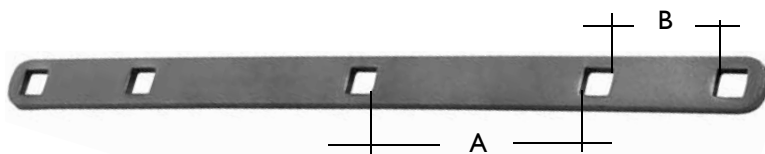

Cod.art./Art.no.	Sezione Section	Foro Hole	Luce A Distance A	Luce B Distance B	Lunghezza Length
GD128/50	25 x 6 mm	12 x 12 mm	100 mm	50 mm	375 mm
GD128/58	25 x 6 mm	Ø 14 mm	100 mm	50 mm	375 mm
GD128/54	30 x 6 mm	14 x 14 mm	100 mm	50 mm	385 mm
GD128/62	30 x 6 mm	Ø 14 mm	100 mm	50 mm	385 mm

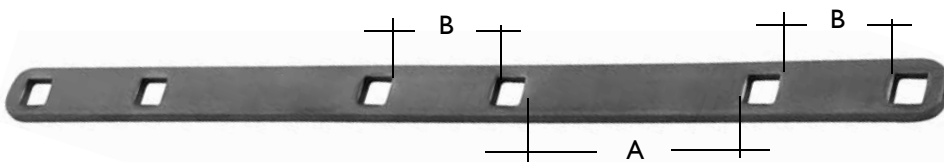

Cod.art./Art.no.	Sezione Section	Foro Hole	Luce A Distance A	Luce B Distance B	Lunghezza Length
GD128/61	25 x 6 mm	12 x 12 mm	100 mm	50 mm	435 mm
GD128/59	25 x 6 mm	Ø 14 mm	100 mm	50 mm	435 mm
GD128/55	30 x 6 mm	14 x 14 mm	100 mm	50 mm	450 mm
GD128/63	30 x 6 mm	Ø 14 mm	100 mm	50 mm	450 mm

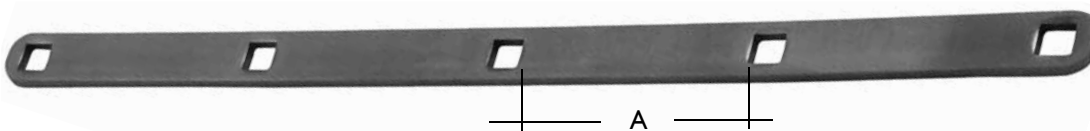

Cod.art./Art.no.	Sezione Section	Foro Hole	Luce A Distance A	Luce B Distance B	Lunghezza Length
GD128/52	25 x 6 mm	12 x 12 mm	100 mm	-	475 mm
GD128/60	25 x 6 mm	Ø 14 mm	100 mm	-	475 mm
GD128/56	30 x 6 mm	14 x 14 mm	100 mm	-	485 mm
GD128/64	30 x 6 mm	Ø 14 mm	100 mm	-	485 mm

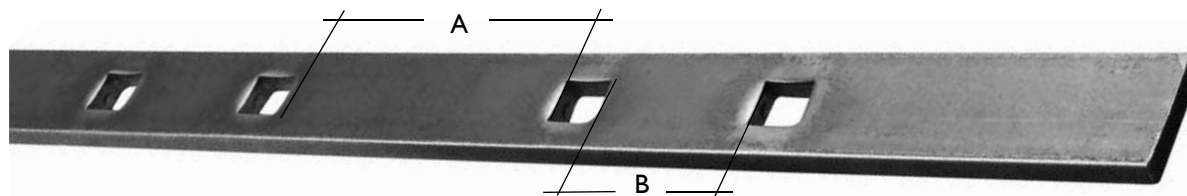

Cod.art./Art.no.	Sezione Section	Foro Hole	Luce A Distance A	Numero spazi A No. of A spaces	Luce B Distance B	Numero spazi B No. of B spaces	Lunghezza Length
GD128/1	25 x 8 mm	13 x 13 mm	100 mm	11	65 mm	10	2000 mm
GD128/25		Ø 13 mm	100 mm	11	65 mm	10	2000 mm
GD128/2		13 x 13 mm	115 mm	10	70 mm	9	2000 mm
GD128/26		Ø 13 mm	115 mm	10	70 mm	9	2000 mm
GD128/3		15 x 15 mm	130 mm	9	75 mm	8	2000 mm
GD128/27		Ø 15 mm	130 mm	9	75 mm	8	2000 mm
GD128/13		15 x 15 mm	100 mm	11	60 mm	10	2000 mm
GD128/37		Ø 15 mm	100 mm	11	60 mm	10	2000 mm
GD128/14		15 x 15 mm	115 mm	10	65 mm	9	2000 mm
GD128/38		Ø 15 mm	115 mm	10	65 mm	9	2000 mm
GD128/15		15 x 15 mm	130 mm	9	70 mm	8	2000 mm
GD128/39		Ø 15 mm	130 mm	9	70 mm	8	2000 mm
GD128/4		30 x 8 mm	13 x 13 mm	100 mm	11	65 mm	10
GD128/28	Ø 13 mm		100 mm	11	65 mm	10	2000 mm
GD128/5	13 x 13 mm		115 mm	10	70 mm	9	2000 mm
GD128/29	Ø 13 mm		115 mm	10	70 mm	9	2000 mm
GD128/6	15 x 15 mm		130 mm	9	75 mm	8	2000 mm
GD128/30	Ø 15 mm		130 mm	9	75 mm	8	2000 mm
GD128/16	15 x 15 mm		100 mm	11	60 mm	10	2000 mm
GD128/40	Ø 15 mm		100 mm	11	60 mm	10	2000 mm
GD128/17	15 x 15 mm		115 mm	10	65 mm	9	2000 mm
GD128/41	Ø 15 mm		115 mm	10	65 mm	9	2000 mm
GD128/18	15 x 15 mm		130 mm	9	70 mm	8	2000 mm
GD128/42	Ø 15 mm		130 mm	9	70 mm	8	2000 mm
GD128/7	35 x 8 mm		13 x 13 mm	100 mm	11	65 mm	10
GD128/31		Ø 13 mm	100 mm	11	65 mm	10	2000 mm
GD128/8		13 x 13 mm	115 mm	10	70 mm	9	2000 mm
GD128/32		Ø 13 mm	115 mm	10	70 mm	9	2000 mm
GD128/9		15 x 15 mm	130 mm	9	75 mm	8	2000 mm
GD128/33		Ø 15 mm	130 mm	9	75 mm	8	2000 mm
GD128/19		15 x 15 mm	100 mm	11	60 mm	10	2000 mm
GD128/43		Ø 15 mm	100 mm	11	60 mm	10	2000 mm
GD128/20		15 x 15 mm	115 mm	10	65 mm	9	2000 mm
GD128/44		Ø 15 mm	115 mm	10	65 mm	9	2000 mm
GD128/21		15 x 15 mm	130 mm	9	70 mm	8	2000 mm
GD128/45		Ø 15 mm	130 mm	9	70 mm	8	2000 mm
GD128/10		40 x 8 mm	13 x 13 mm	100 mm	11	65 mm	10
GD128/34	Ø 13 mm		100 mm	11	65 mm	10	2000 mm
GD128/11	13 x 13 mm		115 mm	10	70 mm	9	2000 mm
GD128/35	Ø 13 mm		115 mm	10	70 mm	9	2000 mm
GD128/12	15 x 15 mm		130 mm	9	75 mm	8	2000 mm
GD128/36	Ø 15 mm		130 mm	9	75 mm	8	2000 mm
GD128/22	15 x 15 mm		100 mm	11	60 mm	10	2000 mm
GD128/46	Ø 15 mm		100 mm	11	60 mm	10	2000 mm
GD128/23	15 x 15 mm		115 mm	10	65 mm	9	2000 mm
GD128/47	Ø 15 mm		115 mm	10	65 mm	9	2000 mm
GD128/24	15 x 15 mm		130 mm	9	70 mm	8	2000 mm
GD128/48	Ø 15 mm		130 mm	9	70 mm	8	2000 mm

foro/hole
Ø 14 mm

Art. 608/1
interasse/pitch 130 mm
n. 13 fori/holes

Art. 608/2
interasse/pitch 100 mm
n. 13 fori/holes



foro/hole
Ø 14 x 14 mm

Art. 608/3
interasse / pitch 130 mm
n. 13 fori/holes

Art. 608/4
interasse / pitch 100 mm
n. 15 fori/holes



Art. 611/12

L 1850 mm
n. 13 borchie/bushes

Art. 611/11

L 1590 mm
n. 11 borchie / bushes

Art. 611/10

L 1330 mm
n. 9 borchie / bushes

Art. 611/9

L 1070 mm
n. 7 borchie / bushes

Art. 611/8

L 810 mm
n. 5 borchie / bushes

Art. 611/7

L 550 mm
n. 3 borchie / bushes



SECUFER®

vedi anche pagina 348
see also page 348

Ø 14 x 14 mm





Art. 614/4
 \varnothing 14 x 14 mm
 interasse/pitch 125 mm
 L 2000 mm
 n. 15 borchie / bushes



Art. 611/1
 L 570 mm
 n. 3 borchie/bushes

Art. 611/2
 L 830 mm
 n. 5 borchie/bushes

Art. 611/3
 L 1090 mm
 n. 7 borchie/bushes

Art. 611/4
 L 1350 mm
 n. 9 borchie/bushes

Art. 611/5
 L 1610 mm
 n. 11 borchie/bushes

Art. 611/6
 L 1870 mm
 n. 13 borchie/bushes

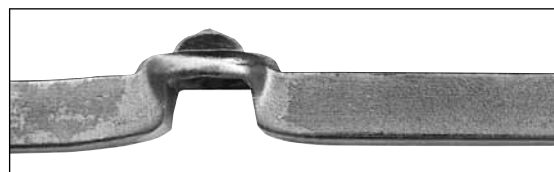





Art. 614/6
 \varnothing 14 x 14 mm
 interasse/pitch 125 mm
 L 2000 mm
 n. 15 borchie / bushes

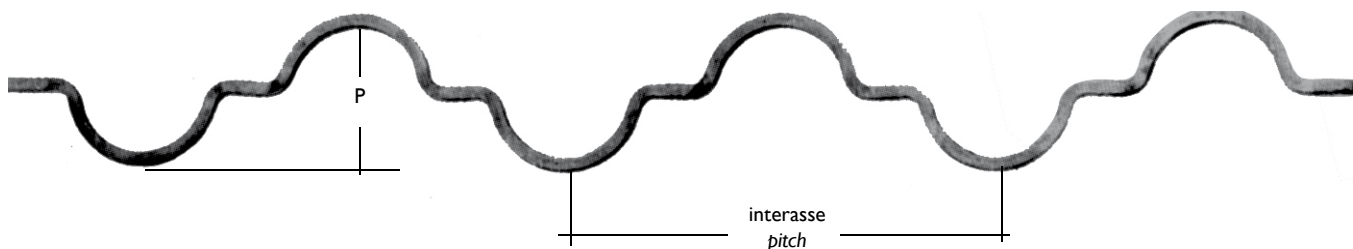

BARRE FORATE - PIERCED BARS

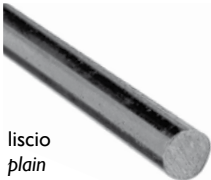
ARTEFERRO



	Sezione Section	Cod.art./Art.no.	interasse Pitch	P	Lunghezza Length
 liscio plain	⌀ 8 x 8 mm	38/1	240 mm	84 mm	1600 mm
	▧ 12 x 6 mm	38/2	240 mm	80 mm	1600 mm
	⌀ 10 x 10 mm	38/3	250 mm	95 mm	1600 mm
	⌀ 12 x 12 mm	38/4	260 mm	100 mm	1600 mm
	⌀ 10 mm	1846/1	180 mm	100 mm	2000 mm
 spigolato hammered on edges	⌀ 12 x 12 mm	621/1	260 mm	100 mm	1600 mm
 corteccia three bark effect	⌀ 12 x 12 mm	1358/1	260 mm	100 mm	1600 mm
	⌀ 12 x 12 mm	1358/2	260 mm	100 mm	1600 mm
	⌀ 12 x 12 mm	620/1	260 mm	100 mm	1600 mm

L 6000 mm - interasse/pitch 178 mm  STAMPATE SULLO SPIGOLO STAMPED ON EDGE

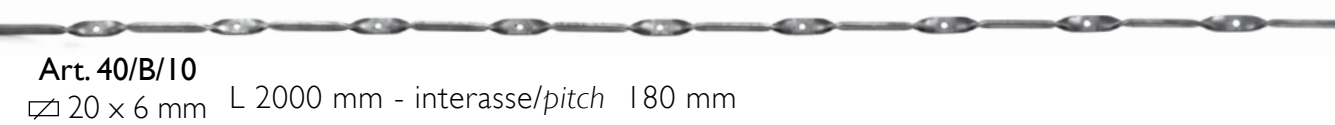
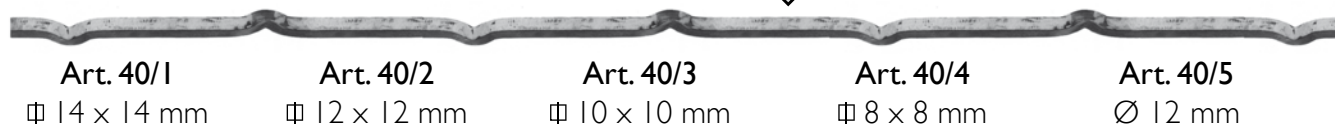

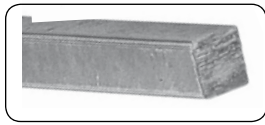

Art. 39/1 - $\Phi 8 \times 8$ mm - L 1600 mm
Lato interno - *Internal square* A = 120 mm

Art. 39/2 - $\Phi 8 \times 8$ mm - L 1600 mm
Lato interno - *Internal square* A = 160 mm

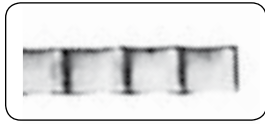

Art. 597/5 - $\square 16 \times 8$ mm - L 1600 mm

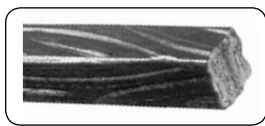
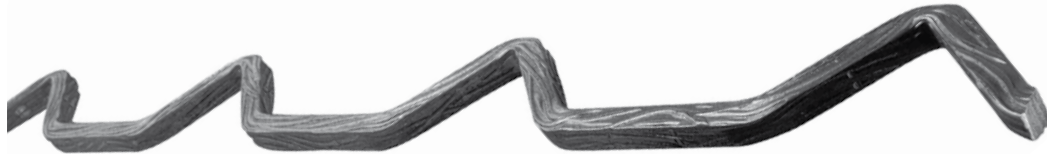

Art. 1356/2 - $\Phi 12 \times 12$ mm - L 1750 mm
A = 75 mm - B = 220 mm

Art. 1358/3 - $\Phi 12 \times 12$ mm - L 1600 mm
A = 75 mm - B = 220 mm

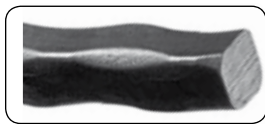

Art. 1356/1 - $\Phi 12 \times 12$ mm - L 1750 mm
A = 75 mm - B = 220 mm

Art. 1358/4 - $\Phi 12 \times 12$ mm - L 1600 mm
A = 75 mm - B = 220 mm

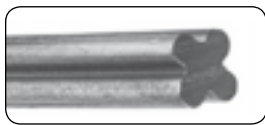

Art. 1356/3 - $\Phi 12 \times 12$ mm - L 1750 mm
A = 75 mm - B = 220 mm

Art. 1358/5 - $\Phi 12 \times 12$ mm - L 1600 mm
A = 75 mm - B = 220 mm

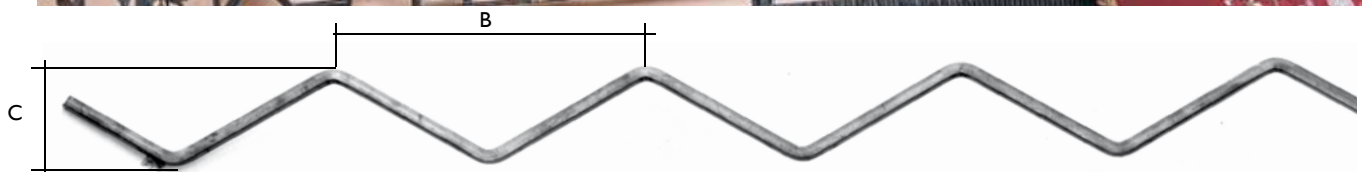
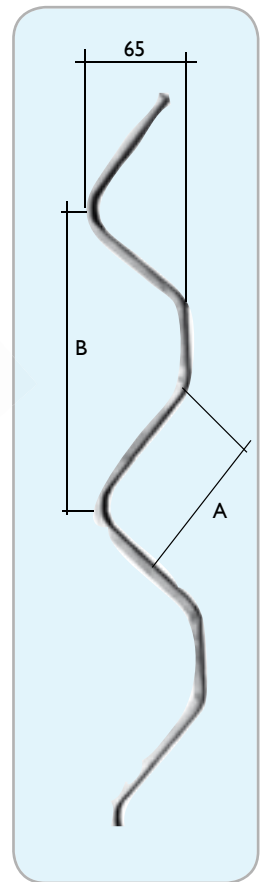

Art. 40/B/3
 $\Phi 12 \times 12$ mm
Art. 40/B/4
 $\Phi 8 \times 8$ mm

Art. 40/B/5
 $\square 12 \times 6$ mm
Art. 40/B/6
 $\Phi 10 \times 10$ mm

Art. 40/B/7
 $\Phi 14 \times 14$ mm

L 2000 mm
B = 300 mm
C = 91 mm

A

Art. 41/2
 $\square 30 \times 8$ mm
 L 2000 mm



B

Art. 41/3
 $\square 30 \times 8$ mm
 L 2000 mm

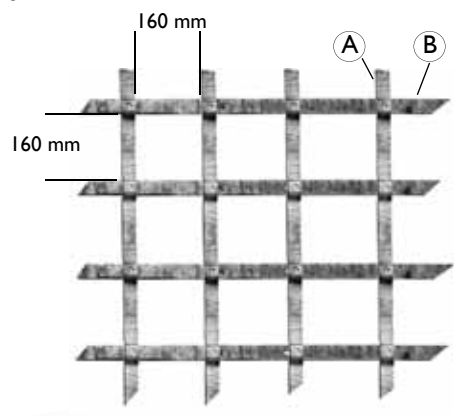

Art. 135/3
 $\Phi 16 \times 16$ mm
 H 650 mm
 foro hole 16×16 mm

fori - holes $\Phi 14 \times 14$ mm

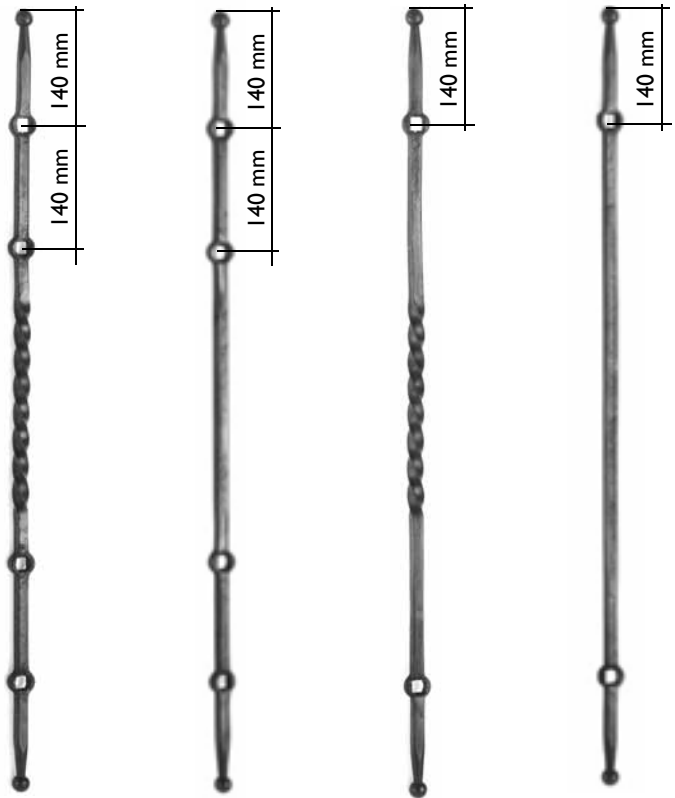

Art. 42/B/1 $\Phi 14 \times 14$ mm H 900 mm
Art. 42/B/2 $\Phi 14 \times 14$ mm H 900 mm
Art. 42/B/3 $\Phi 14 \times 14$ mm H 700 mm
Art. 42/B/4 $\Phi 14 \times 14$ mm H 700 mm

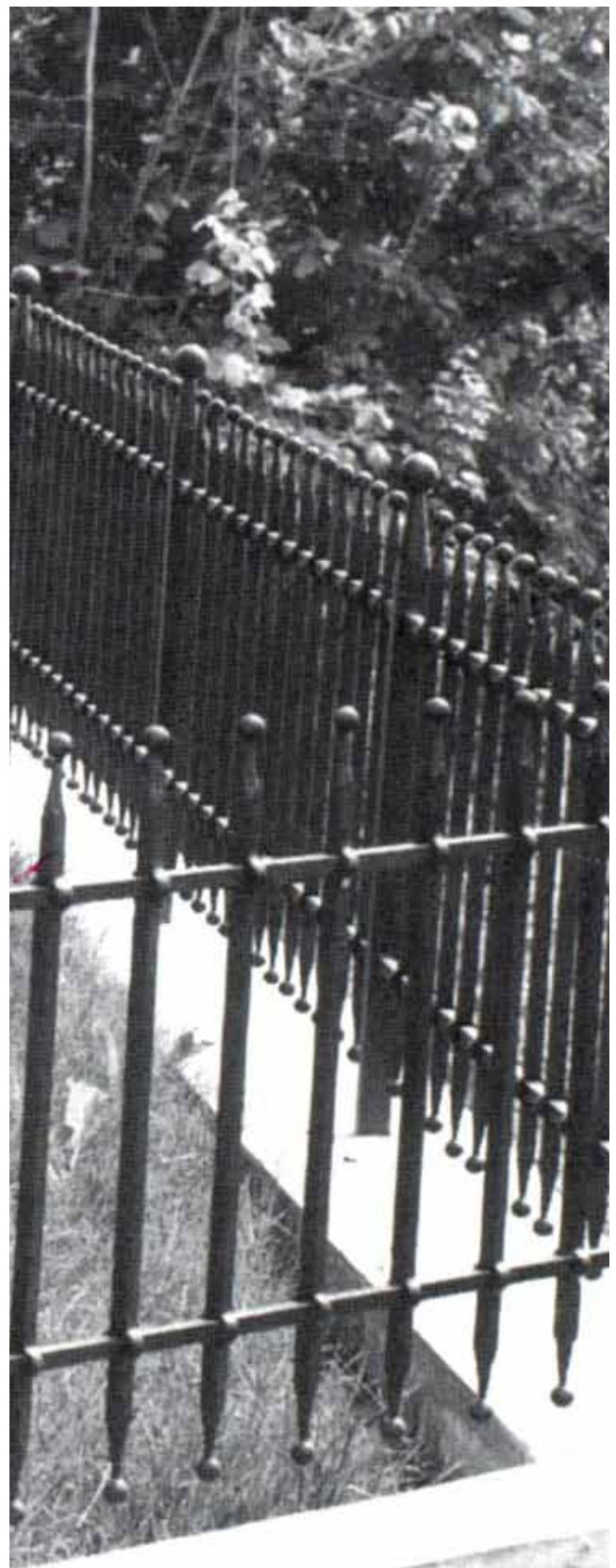

ARTEFERRO

PIANTONI FORATI a CALDO *HOT PIERCED NEWEL POSTS*

Foro/Hole per/for \varnothing 30 mm

PRODUCIBILI ANCHE SU MISURA E CON FORI OVALI
DIFFERENT SIZES AND WITH OVAL HOLES ON DEMAND



H 1100 mm	H 1200 mm	H 1200 mm	H 1200 mm
Art. 200/1	Art. 200/11	Art. 200/13	Art. 200/15
\varnothing 40 x 40 mm	\varnothing 40 x 40 mm	\varnothing 40 x 40 mm	\varnothing 40 x 40 mm
Art. 200/3	Art. 200/12	Art. 200/14	Art. 200/16
\varnothing 30 x 30 mm	\varnothing 30 x 30 mm	\varnothing 30 x 30 mm	\varnothing 30 x 30 mm

H 1100 mm	H 1100 mm
Art. 200/8	Art. 200/6
\varnothing 40 x 40 mm	\varnothing 40 x 40 mm
Art. 200/9	Art. 200/7
\varnothing 30 x 30 mm	\varnothing 30 x 30 mm

sfera/sphere \varnothing 80 mm
Art. 200/7
 \varnothing 30 x 30 mm
sfera/sphere \varnothing 70 mm



BARRE FORATE - PIERCED BARS

PRODUCIBILI ANCHE SU MISURA E CON FORI OVALI
DIFFERENT SIZES AND WITH OVAL HOLES ON DEMAND



interasse/pitch 450 mm

fori/holes Ø 31 mm

H 1100 mm
Art. 200/4
Ø 40 mm
Art. 200/5
Ø 30 mm



interasse/pitch 320 mm

fori/holes Ø 31 mm

H 1200 mm
Art. 200/17
Ø 40 mm
Art. 200/18
Ø 30 mm



interasse/pitch 450 mm

fori/holes Ø 31 mm

H 1200 mm
Art. 200/19
Ø 40 mm
Art. 200/20
Ø 30 mm



interasse/pitch 320 mm

fori/holes Ø 31 mm

H 1200 mm
Art. 200/21
Ø 40 mm
Art. 200/22
Ø 30 mm

BARRE FORATE - PIERCED BARS



ARTEFERRO



PALETTI PER RECINZIONE - PICKETS FOR FENCING

COMPENDIUM 2011

Art. 1133/13
Art. 1260/2
Art. 1259/21
Art. 1766/5
Art. 1754/10



ARTEFERRO

QUALSIASI ALTEZZA
SU RICHIESTA

SPECIAL HEIGHT
UPON REQUEST

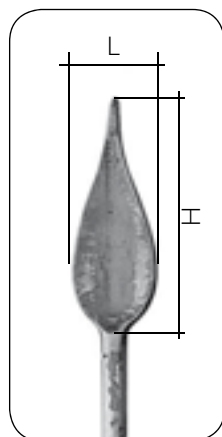

Sez./Sect.	H	L
12 mm	115 mm	43 mm
14 mm	128 mm	50 mm

QUALSIASI
ALTEZZA
SU RICHIESTA

SPECIAL HEIGHT
UPON REQUEST

H	Cod.art./Art.no. Ø 12 x 12 mm	Cod.art./Art.no. Ø 14 x 14 mm	Cod.art./Art.no. Ø 12 x 12 mm	Cod.art./Art.no. Ø 14 x 14 mm	Cod.art./Art.no. Ø 12 x 12 mm	Cod.art./Art.no. Ø 14 x 14 mm
200 mm	129/10	129/9	-	-	-	-
800 mm	130/31	130/36	-	-	-	-
900 mm	130/32	130/37	-	-	-	-
1000 mm	130/33	130/38	1263/27	1263/28	-	-
1200 mm	130/34	130/39	1263/29	1263/30	-	-
1500 mm	130/35	130/40	1263/31	1263/32	-	-

H	Ø 12 mm	Ø 14 mm	Ø 12 mm	Ø 14 mm	Ø 12 x 12 mm	Ø 14 x 14 mm
200 mm	1385/7	1385/8	-	-	-	-
800 mm	-	-	-	-	-	-
900 mm	-	-	-	-	-	-
1000 mm	1262/37	1262/38	1262/43	1262/44	-	-
1200 mm	1262/39	1262/40	1262/45	1262/46	-	-
1500 mm	1262/41	1262/42	1262/47	1262/48	-	-

H	Ø 12 x 12 mm	Ø 14 x 14 mm	Ø 12 x 12 mm	Ø 14 x 14 mm	Ø 12 x 12 mm	Ø 14 x 14 mm
200 mm	-	-	-	-	-	-
800 mm	-	-	-	-	-	-
900 mm	-	-	-	-	-	-
1000 mm	1261/31	1261/32	1261/19	1261/20	1261/25	1261/26
1200 mm	1261/33	1261/34	1261/21	1261/22	1261/27	1261/28
1500 mm	1261/35	1261/36	1261/23	1261/24	1261/29	1261/30

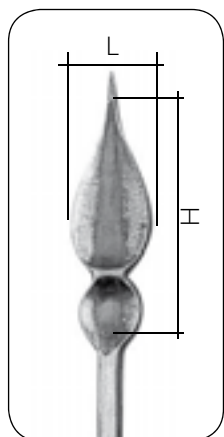

QUALSIASI
ALTEZZA
SU RICHIESTA

SPECIAL HEIGHT
UPON REQUEST

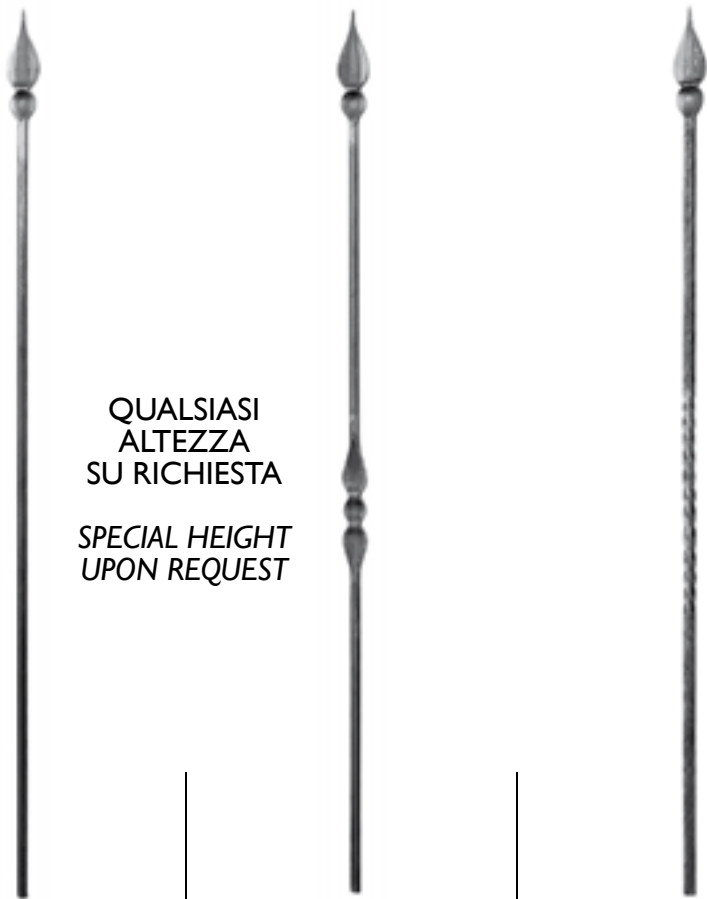

Sez./Sect.	H	L
12 mm	145 mm	43 mm
14 mm	156 mm	50 mm



H	Cod.art./Art.no. Ø 12 x 12 mm	Cod.art./Art.no. Ø 14 x 14 mm	Cod.art./Art.no. Ø 12 x 12 mm	Cod.art./Art.no. Ø 14 x 14 mm	Cod.art./Art.no. Ø 12 x 12 mm	Cod.art./Art.no. Ø 14 x 14 mm
200 mm	129/8	129/7	-	-	-	-
800 mm	130/1	130/6	134/17	134/20	-	-
900 mm	130/2	130/7	-	-	-	-
1000 mm	130/3	130/8	134/18	134/21	-	-
1200 mm	130/4	130/9	134/19	134/22	-	-
1500 mm	130/5	130/10	1263/25	1263/26	-	-



H	Ø 12 mm	Ø 14 mm	Ø 12 mm	Ø 14 mm	Ø 12 x 12 mm	Ø 14 x 14 mm
200 mm	1385/4	1385/5	-	-	-	-
800 mm	-	-	-	-	-	-
900 mm	-	-	-	-	-	-
1000 mm	1262/25	1262/26	1262/31	1262/32	-	-
1200 mm	1262/27	1262/28	1262/33	1262/34	-	-
1500 mm	1262/29	1262/30	1262/35	1262/36	-	-



H	Ø 12 x 12 mm	Ø 14 x 14 mm	Ø 12 x 12 mm	Ø 14 x 14 mm	Ø 12 x 12 mm	Ø 14 x 14 mm
200 mm	-	-	-	-	-	-
800 mm	-	-	-	-	-	-
900 mm	-	-	-	-	-	-
1000 mm	1261/49	1261/50	1261/37	1261/38	1261/43	1261/44
1200 mm	1261/51	1261/52	1261/3	1261/40	1261/45	1261/46
1500 mm	1261/53	1261/54	1261/41	1261/42	1261/47	1261/48



H	Ø 12 x 12 mm	Ø 14 x 14 mm	Ø 12 x 12 mm	Ø 14 x 14 mm	Ø 12 x 12 mm	Ø 14 x 14 mm
200 mm	-	-	-	-	-	-
800 mm	-	-	-	-	-	-
900 mm	-	-	-	-	-	-
1000 mm	1261/67	1261/68	1261/55	1261/56	1261/61	1261/62
1200 mm	1261/69	1261/70	1261/57	1261/58	1261/63	1261/64
1500 mm	1261/71	1261/72	1261/59	1261/60	1261/65	1261/66

PALETTI per RECINZIONE - PICKETS for FENCINGS



ARTEFERRO

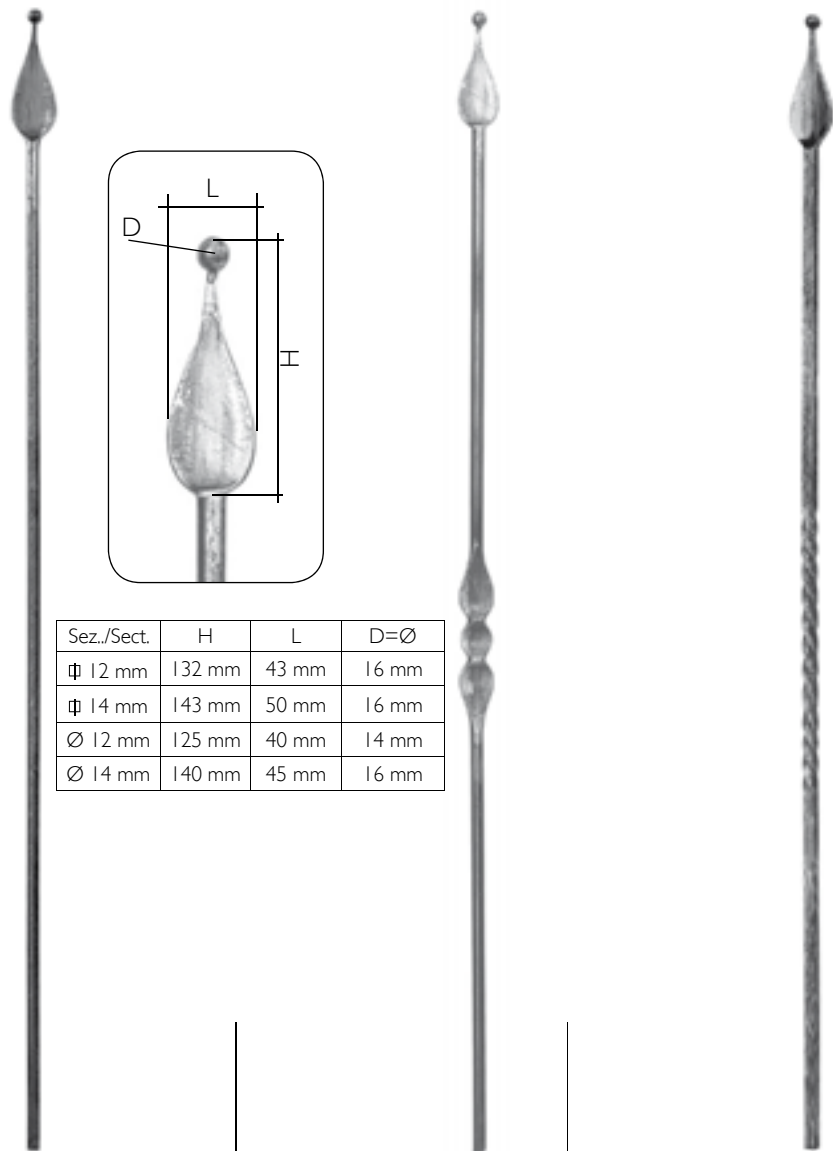

Sez./Sect.	H	L	D=Ø
Φ 12 mm	132 mm	43 mm	16 mm
Φ 14 mm	143 mm	50 mm	16 mm
Ø 12 mm	125 mm	40 mm	14 mm
Ø 14 mm	140 mm	45 mm	16 mm

QUALSIASI ALTEZZA
SU RICHIESTA

SPECIAL HEIGHT
UPON REQUEST



H	Cod.art./Art.no.	Cod.art./Art.no.	Cod.art./Art.no.	Cod.art./Art.no.	Cod.art./Art.no.	Cod.art./Art.no.
200 mm	Φ 12 x 12 mm	Φ 14 x 14 mm	Φ 12 x 12 mm	Φ 14 x 14 mm	Φ 12 x 12 mm	Φ 14 x 14 mm
800 mm	-	-	-	-	-	-
900 mm	-	-	-	-	-	-
1000 mm	1263/13	1263/14	1263/19	1263/20	-	-
1200 mm	1263/15	1263/16	1263/21	1263/22	-	-
1500 mm	1263/17	1263/18	1263/23	1263/24	-	-

H	Cod.art./Art.no.	Cod.art./Art.no.	Cod.art./Art.no.	Cod.art./Art.no.	Cod.art./Art.no.	Cod.art./Art.no.
200 mm	Ø 12 mm	Ø 14 mm	Ø 12 mm	Ø 14 mm	Φ 12 x 12 mm	Φ 14 x 14 mm
800 mm	-	-	-	-	-	-
900 mm	-	-	-	-	-	-
1000 mm	1262/13	1262/14	1262/19	1262/20	-	-
1200 mm	1262/15	1262/16	1262/21	1262/22	-	-
1500 mm	1262/17	1262/18	1262/23	1262/24	-	-

H	Cod.art./Art.no.	Cod.art./Art.no.	Cod.art./Art.no.	Cod.art./Art.no.	Cod.art./Art.no.	Cod.art./Art.no.
200 mm	Φ 12 x 12 mm	Φ 14 x 14 mm	Φ 12 x 12 mm	Φ 14 x 14 mm	Φ 12 x 12 mm	Φ 14 x 14 mm
800 mm	-	-	-	-	-	-
900 mm	-	-	-	-	-	-
1000 mm	1260/31	1260/32	1260/19	1260/20	1260/25	1260/26
1200 mm	1260/33	1260/34	1260/21	1260/22	1260/27	1260/28
1500 mm	1260/35	1260/36	1260/23	1260/24	1260/29	1260/30

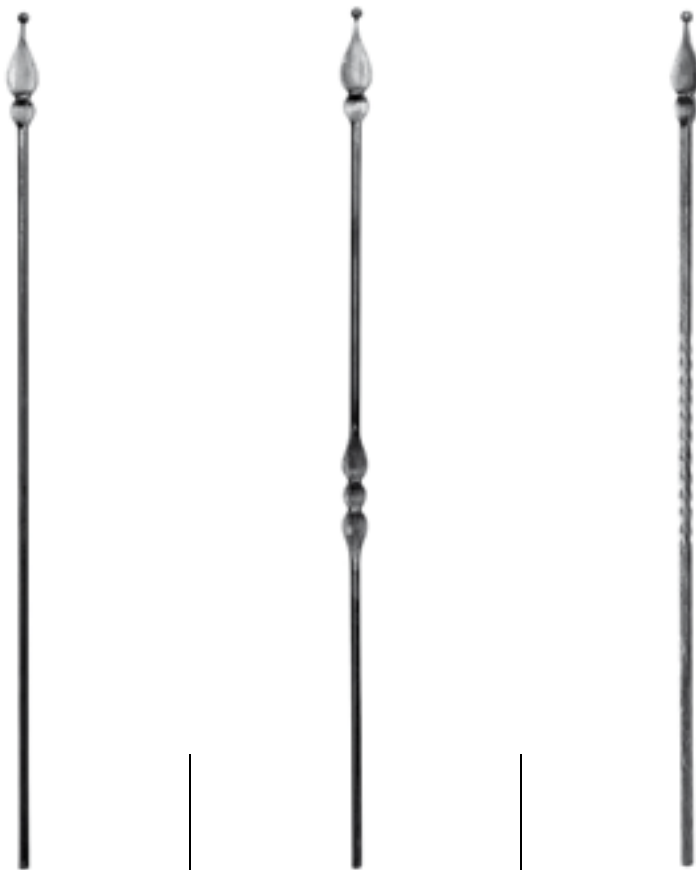
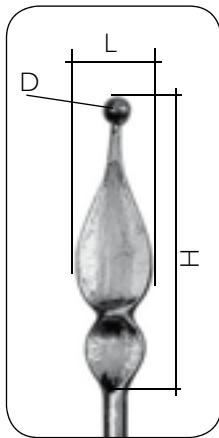

Sez./Sect.	H	L	D=Ø
Φ 12 mm	155 mm	43 mm	16 mm
Φ 14 mm	163 mm	50 mm	16 mm
Ø 12 mm	150 mm	40 mm	14 mm
Ø 14 mm	163 mm	45 mm	16 mm

**QUALSIASI ALTEZZA
SU RICHIESTA**

**SPECIAL HEIGHT
UPON REQUEST**



	Cod.art./Art.no.	Cod.art./Art.no.	Cod.art./Art.no.	Cod.art./Art.no.	Cod.art./Art.no.	Cod.art./Art.no.
H	Φ 12 x 12 mm	Φ 14 x 14 mm	Φ 12 x 12 mm	Φ 14 x 14 mm	Φ 12 x 12 mm	Φ 14 x 14 mm
200 mm	722/3	722/4	-	-	-	-
800 mm	-	-	-	-	-	-
900 mm	-	-	-	-	-	-
1000 mm	1263/1	1263/2	1263/7	1263/8	-	-
1200 mm	1263/3	1263/4	1263/9	1263/10	-	-
1500 mm	1263/5	1263/6	1263/11	1263/12	-	-

	Cod.art./Art.no.	Cod.art./Art.no.	Cod.art./Art.no.	Cod.art./Art.no.	Cod.art./Art.no.	Cod.art./Art.no.
H	Ø 12 mm	Ø 14 mm	Ø 12 mm	Ø 14 mm	Φ 12 x 12 mm	Φ 14 x 14 mm
200 mm	1385/10	1385/11	-	-	-	-
800 mm	-	-	-	-	-	-
900 mm	-	-	-	-	-	-
1000 mm	1262/1	1262/2	1262/7	1262/8	-	-
1200 mm	1262/3	1262/4	1262/9	1262/10	-	-
1500 mm	1262/5	1262/6	1262/11	1262/12	-	-

	Cod.art./Art.no.	Cod.art./Art.no.	Cod.art./Art.no.	Cod.art./Art.no.	Cod.art./Art.no.	Cod.art./Art.no.
H	Φ 12 x 12 mm	Φ 14 x 14 mm	Φ 12 x 12 mm	Φ 14 x 14 mm	Φ 12 x 12 mm	Φ 14 x 14 mm
200 mm	-	-	-	-	-	-
800 mm	-	-	-	-	-	-
900 mm	-	-	-	-	-	-
1000 mm	1260/49	1260/50	1260/37	1260/38	1260/43	1260/44
1200 mm	1260/51	1260/52	1260/39	1260/40	1260/45	1260/46
1500 mm	1260/53	1260/54	1260/41	1260/42	1260/47	1260/48

	Cod.art./Art.no.	Cod.art./Art.no.	Cod.art./Art.no.	Cod.art./Art.no.	Cod.art./Art.no.	Cod.art./Art.no.
H	Φ 12 x 12 mm	Φ 14 x 14 mm	Φ 12 x 12 mm	Φ 14 x 14 mm	Φ 12 x 12 mm	Φ 14 x 14 mm
200 mm	-	-	-	-	-	-
800 mm	-	-	-	-	-	-
900 mm	-	-	-	-	-	-
1000 mm	1260/67	1260/68	1260/55	1260/56	1260/61	1260/62
1200 mm	1260/69	1260/70	1260/57	1260/58	1260/63	1260/64
1500 mm	1260/71	1260/72	1260/59	1260/60	1260/65	1260/66

PALETTI per RECINZIONE - PICKETS for FENCINGS

QUALSIASI ALTEZZA
SU RICHIESTA

ANY HEIGHT
ON REQUEST

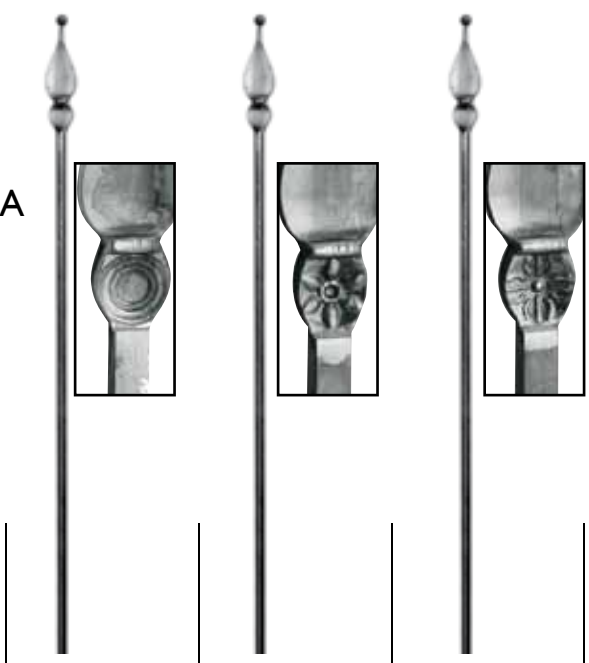

H	Sez.Sect	Cod.art./Art.no.	Cod.art./Art.no.	Cod.art./Art.no.
800 mm	Φ 12 x 12 mm	1765/12	1765/27	1765/42
	Φ 14 x 14 mm	1765/17	1765/32	1765/47
	Φ 16 x 16 mm	1765/22	1765/37	1765/52
1000 mm	Φ 12 x 12 mm	1765/13	1765/28	1765/43
	Φ 14 x 14 mm	1765/18	1765/33	1765/48
	Φ 16 x 16 mm	1765/23	1765/38	1765/53
1200 mm	Φ 12 x 12 mm	1765/14	1765/29	1765/44
	Φ 14 x 14 mm	1765/19	1765/34	1765/49
	Φ 16 x 16 mm	1765/24	1765/39	1765/54
1500 mm	Φ 12 x 12 mm	1765/15	1765/30	1765/45
	Φ 14 x 14 mm	1765/20	1765/35	1765/50
	Φ 16 x 16 mm	1765/25	1765/40	1765/55

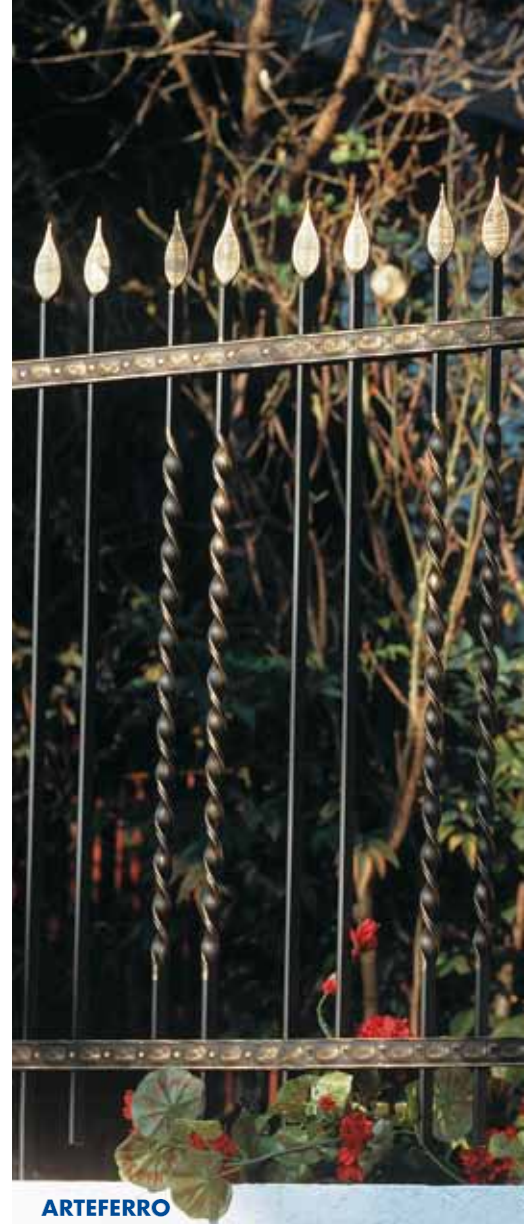

ARTEFERRO

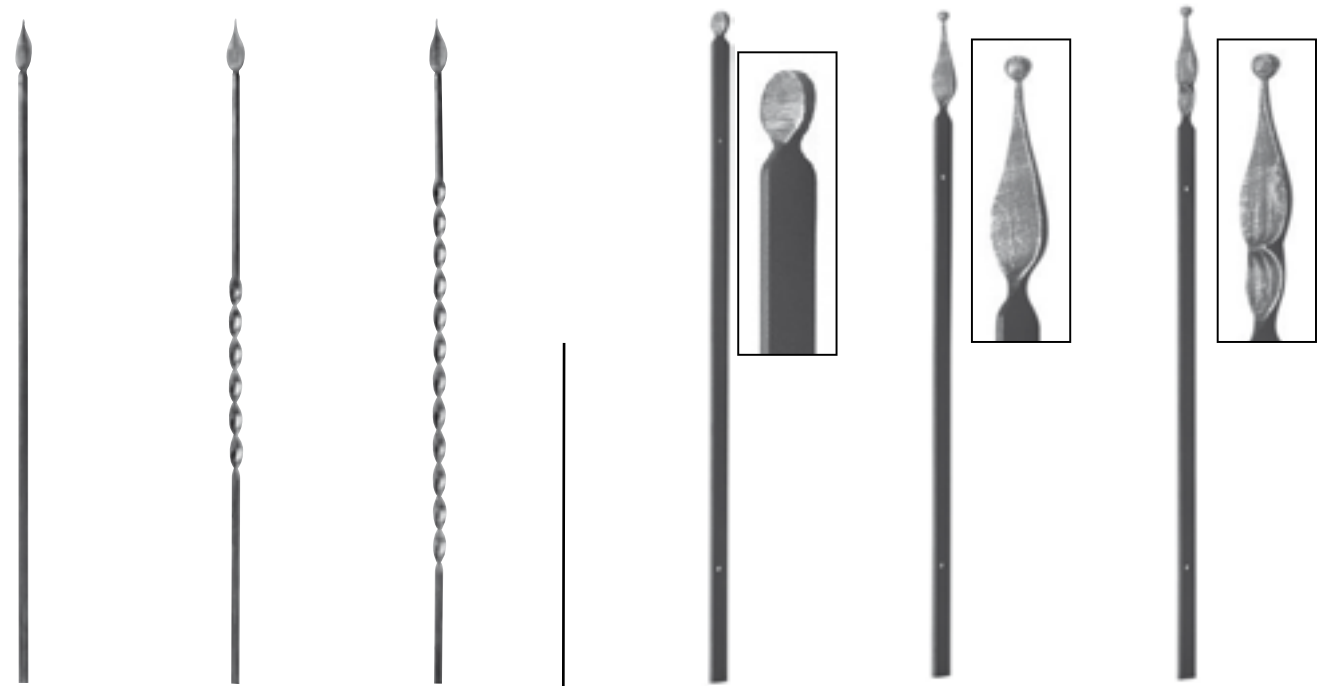

Art. 1765/9 ∅ 20 x 6 mm H 1000 mm	Art. 1765/7 ∅ 20 x 6 mm H 1000 mm	Art. 1765/5 ∅ 20 x 6 mm H 1000 mm
Art. 1765/10 ∅ 20 x 6 mm H 1200 mm	Art. 1765/8 ∅ 20 x 6 mm H 1200 mm	Art. 1765/6 ∅ 20 x 6 mm H 1200 mm

Art. 6352/3 ∅ 30 x 8 mm H 1000 mm	Art. 6355/3 ∅ 30 x 8 mm H 1000 mm	Art. 6356/3 ∅ 30 x 8 mm H 1000 mm
Art. 6352/4 ∅ 30 x 8 mm H 1200 mm	Art. 6355/4 ∅ 30 x 8 mm H 1200 mm	Art. 6356/4 ∅ 30 x 8 mm H 1200 mm



QUALSIASI ALTEZZA
SU RICHIESTA

SPECIAL HEIGHT
UPON REQUEST



	Cod.art./Art.no.	Cod.art./Art.no.	Cod.art./Art.no.	Cod.art./Art.no.	Cod.art./Art.no.	Cod.art./Art.no.
H	Φ 12 x 12 mm	Φ 14 x 14 mm	Φ 12 x 12 mm	Φ 14 x 14 mm	Φ 12 x 12 mm	Φ 14 x 14 mm
200 mm	129/12	-	-	-	-	-
230 mm	-	129/11	-	-	-	-
800 mm	130/41	130/46	-	-	-	-
900 mm	130/42	130/47	-	-	-	-
1000 mm	130/43	130/48	-	-	-	-
1200 mm	130/44	130/49	-	-	-	-
1500 mm	130/45	130/50	-	-	-	-
H	Φ 12 x 12 mm	Φ 14 x 14 mm	Φ 12 x 12 mm	Φ 14 x 14 mm	Φ 12 x 12 mm	Φ 14 x 14 mm
200 mm	-	-	-	-	-	-
800 mm	-	-	-	-	-	-
900 mm	-	-	-	-	-	-
1000 mm	1261/13	1261/14	1261/1	1261/2	1261/7	1261/8
1200 mm	1261/15	1261/16	1261/3	1261/4	1261/9	1261/10
1500 mm	1261/17	1261/18	1261/5	1261/6	1261/11	1261/12



QUALSIASI ALTEZZA
SU RICHIESTA

SPECIAL HEIGHT
UPON REQUEST



	Cod.art./Art.no.	Cod.art./Art.no.	Cod.art./Art.no.	Cod.art./Art.no.	Cod.art./Art.no.	Cod.art./Art.no.
H	Φ 12 x 12 mm	Φ 14 x 14 mm	Φ 12 x 12 mm	Φ 14 x 14 mm	Φ 12 x 12 mm	Φ 14 x 14 mm
1000 mm	1260/13	1260/14	1260/1	1260/2	1260/7	1260/8
1200 mm	1260/15	1260/16	1260/3	1260/4	1260/9	1260/10
1500 mm	1260/17	1260/18	1260/5	1260/6	1260/11	1260/12

NOVITÀ - NOVELTIES



Sez. / Sect.	H	Cod.art. Art.no.	Cod.art. Art.no.	Cod.art. Art.no.	Cod.art. Art.no.	Cod.art. Art.no.	Cod.art. Art.no.
Ø 12 mm	150 mm	1764/22	-	1764/1	-	-	-
	1000 mm	1764/25	1764/34	1764/4	1764/13	-	-
	1200 mm	1764/28	1764/37	1764/7	1764/16	-	-
	1500 mm	1764/31	1764/40	1764/10	1764/19	-	--
Ø 14 mm	150 mm	1764/23	-	1764/2	-	-	-
	1000 mm	1764/26	1764/35	1764/5	1764/14	-	-
	1200 mm	1764/29	1764/38	1764/8	1764/17	-	-
	1500 mm	1764/32	1764/41	1764/11	1764/20	-	-
Ø 16 mm	150 mm	1764/24	-	1764/3	-	-	-
	1000 mm	1764/27	1764/36	1764/6	1764/15	-	-
	1200 mm	1764/30	1764/39	1764/9	1764/18	-	-
	1500 mm	1764/33	1764/42	1764/12	1764/21	-	-
Ø 12 x 12 mm	150 mm	1764/73	-	1764/43	-	-	-
	1000 mm	1764/76	1764/85	1764/46	1764/55	1764/94	1764/64
	1200 mm	1764/79	1764/88	1764/49	1764/58	1764/97	1764/67
	1500 mm	1764/82	1764/91	1764/52	1764/61	1764/100	1764/70
Ø 14 x 14 mm	150 mm	1764/74	-	1764/44	-	-	-
	1000 mm	1764/77	1764/86	1764/47	1764/56	1764/95	1764/65
	1200 mm	1764/80	1764/89	1764/50	1764/59	1764/98	1764/68
	1500 mm	1764/83	1764/92	1764/53	1764/62	1764/101	1764/71
Ø 16 x 16 mm	150 mm	1764/75	-	1764/45	-	-	-
	1000 mm	1764/78	1764/87	1764/48	1764/57	1764/96	1764/66
	1200 mm	1764/81	1764/90	1764/51	1764/60	1764/99	1764/69
	1500 mm	1764/84	1764/93	1764/54	1764/63	1764/102	1764/72

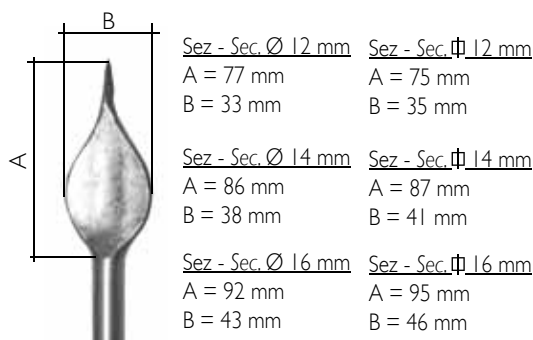

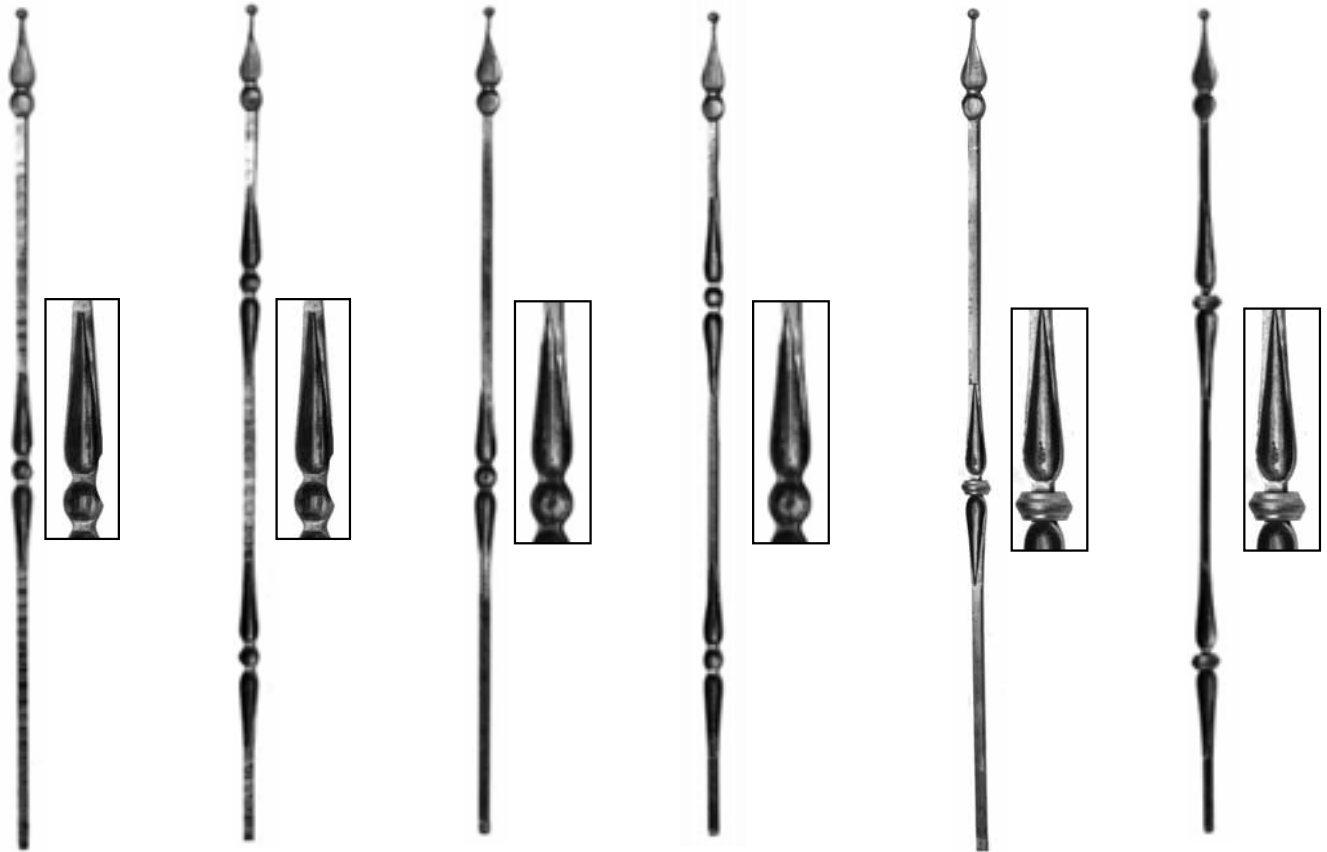

Art. 128/D/1
 Φ 14 x 14 mm
 H 1200 mm

Art. 128/D/2
 Φ 14 x 14 mm
 H 1200 mm

Art. 128/D/5
 Φ 14 x 14 mm
 H 1200 mm

Art. 128/D/3
 Φ 14 x 14 mm
 H 1200 mm

Art. 128/D/6
 Φ 14 x 14 mm
 H 1200 mm

Art. 128/D/4
 Φ 14 x 14 mm
 H 1200 mm



QUALSIASI ALTEZZA
 SU RICHIESTA

ANY HEIGHT
 ON REQUEST

	Cod.art./Art.no.	Cod.art./Art.no.	Cod.art./Art.no.	Cod.art./Art.no.	Cod.art./Art.no.	Cod.art./Art.no.
H	Φ 12 x 12 mm	Φ 14 x 14 mm	Φ 12 x 12 mm	Φ 14 x 14 mm	Φ 12 x 12 mm	Φ 14 x 14 mm
800 mm	130/51	130/56	130/21	130/26	130/11	130/16
900 mm	130/52	130/57	130/22	130/27	130/12	130/17
1000 mm	130/53	130/58	130/23	130/8	130/13	130/18
1200 mm	130/54	130/59	130/24	130/29	130/14	130/19
1500 mm	130/55	130/60	130/25	130/30	130/15	130/20

Art. 1080/9
 Φ 12 mm
 H 1000 mm

Art. 1080/10
 Φ 12 x 12 mm
 H 1000 mm

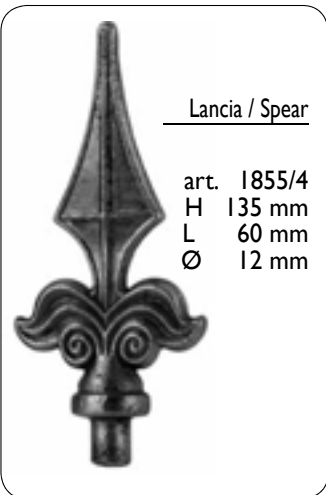

Lancia / Spear

art. 1855/4
 H 135 mm
 L 60 mm
 Ø 12 mm



Sez. / Sect.	H	Cod.art./Art.no.
Ø 12 mm	H 1000 mm	1855/23
	H 1200 mm	1855/24

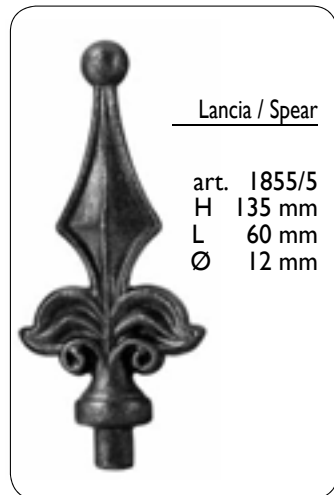

Lancia / Spear

art. 1855/5
 H 135 mm
 L 60 mm
 Ø 12 mm



Sez. / Sect.	H	Cod.art./Art.no.
Ø 12 mm	H 1000 mm	1855/25
	H 1200 mm	1855/26

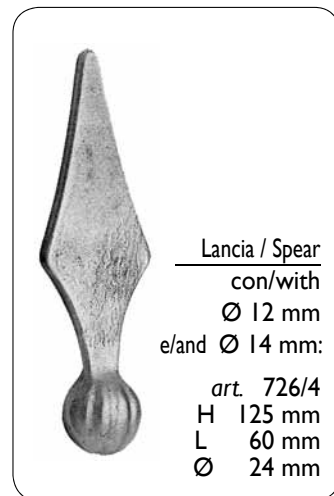

Lancia / Spear

con/with
 Ø 12 mm
 e/and Ø 14 mm:
 art. 726/4
 H 125 mm
 L 60 mm
 Ø 24 mm



Sez. / Sect.	H	Cod.art./Art.no.
Ø 12 mm	H 1000 mm	726/20
	H 1200 mm	726/22
Ø 14 mm	H 1000 mm	726/21
	H 1200 mm	726/23



ARTEFERRO

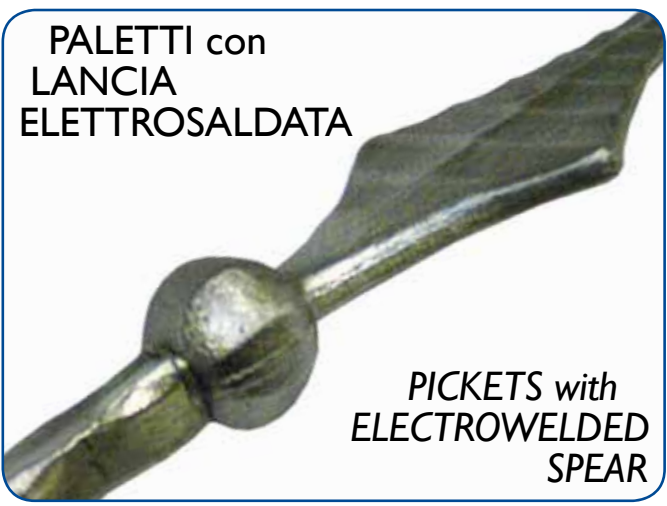

PALETTI con
 LANCIA
 ELETTROSALDATA

PICKETS with
 ELECTROWELDED
 SPEAR



Lancia / Spear

con/with Ø 12 mm
e/and Ø 14 mm

Art.1855/1

H 128 mm
L 65 mm
Ø 24 mm

con/with Ø 14 mm
e/and Ø 16 mm

Art.1855/2

H 140 mm
L 70 mm
Ø 25 mm

con/with Ø 18 mm
e/and Ø 20 mm

Art.1855/3

H 170 mm
L 86 mm
Ø 32 mm



Lancia / Spear

con/with Ø 12 mm

Art.727/3

H 110 mm
L 55 mm
Ø 25 mm

con/with Ø 14 mm

Art.727/2

H 125 mm
L 65 mm
Ø 30 mm

con/with Ø 12 mm

Art.727/1

H 140 mm
L 70 mm
Ø 32 mm

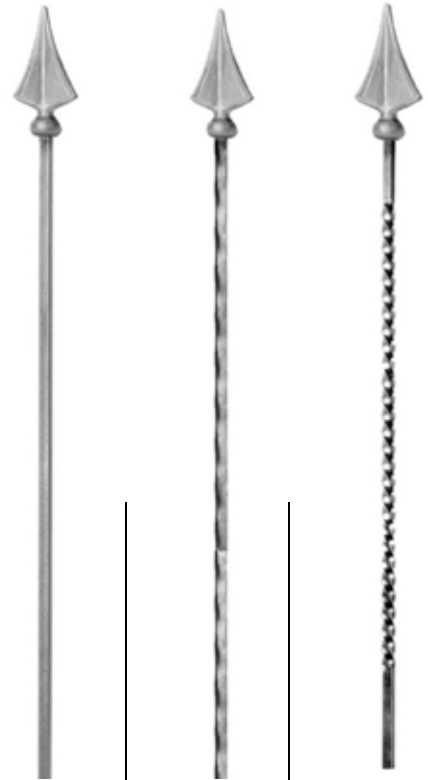

Sez. / Sect.	H	Cod.art./Art.no.
Ø 12 mm	H 1000 mm	1855/11
	H 1200 mm	1855/13
Ø 14 mm	H 1000 mm	1855/12
	H 1200 mm	1855/14
Ø 14 mm	H 1000 mm	1855/15
	H 1200 mm	1855/17
Ø 16 mm	H 1000 mm	1855/16
	H 1200 mm	1855/18
Ø 18 mm	H 1000 mm	1855/19
	H 1200 mm	1855/21
Ø 20 mm	H 1000 mm	1855/20
	H 1200 mm	1855/22

Sez. / Sect.	H	Cod.art./Art.no.	Cod.art./Art.no.	Cod.art./Art.no.
		Liscio / Plain	Spig./Hamm.	Spig./Hamm.
Ø 12 x 12 mm	H 1000 mm	727/24	727/25	727/26
	H 1200 mm	727/27	727/28	727/29
Ø 14 x 14 mm	H 1000 mm	727/18	727/19	727/20
	H 1200 mm	727/21	727/22	727/23
Ø 16 x 16 mm	H 1000 mm	727/12	727/13	727/14
	H 1200 mm	727/15	727/16	727/17

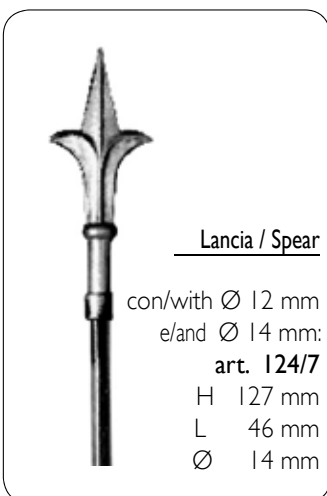

Lancia / Spear

con/with Ø 12 mm
e/and Ø 14 mm:

art. 124/7

H 127 mm
L 46 mm
Ø 14 mm



PALETTI con LANCIA ELETTROSALDATA

PICKETS with ELECTROWELDED SPEAR

Sez. / Sect.	H	Cod.art./Art.no.
Ø 12 mm	H 1000 mm	124/11
	H 1200 mm	124/13
Ø 14 mm	H 1000 mm	124/12
	H 1200 mm	124/14



Lancia / Spear

con/with Ø 12 mm
e/and Ø 14 mm:

art. 727/11

H 120 mm
L 35 mm
Ø 30 mm

con/with Ø 12 mm
e/and Ø 14 mm:

art. 727/10

H 150 mm
L 40 mm
Ø 33 mm



Sez. / Sect.	H	Cod.art./Art.no.
Ø 12 mm	H 1000 mm	727/34
	H 1200 mm	727/36
Ø 14 mm	H 1000 mm	727/35
	H 1200 mm	727/37
Ø 18 mm	H 1000 mm	727/30
	H 1200 mm	727/32
Ø 20 mm	H 1000 mm	727/31
	H 1200 mm	727/33

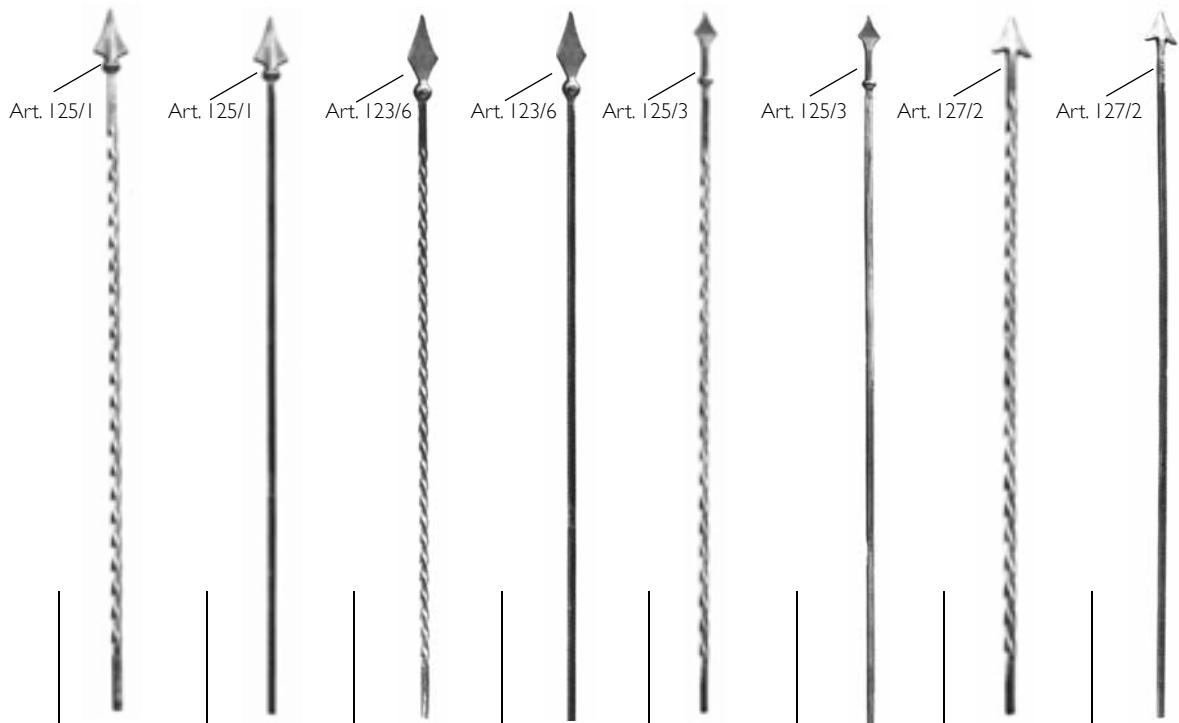

	Cod.art. Art.no.	Cod.art. Art.no.	Cod.art. Art.no.	Cod.art. Art.no.	Cod.art. Art.no.	Cod.art. Art.no.	Cod.art. Art.no.	Cod.art. Art.no.
H	Φ 14 x 14 mm	Φ 14 x 14 mm	Φ 14 x 14 mm	Φ 14 x 14 mm	Φ 12 x 12 mm	Φ 12 x 12 mm	Φ 12 x 12 mm	Φ 12 x 12 mm
800 mm	132/1	132/6	132/14	132/19	132/27	132/32	131/46	131/51
900 mm	132/2	132/7	132/15	132/20	132/28	132/33	131/47	131/52
1000 mm	132/3	132/8	132/16	132/21	132/29	132/34	131/48	131/53
1200 mm	132/4	132/9	132/17	132/22	132/30	132/35	131/49	131/54
1500 mm	132/5	132/10	132/18	132/23	132/31	132/36	131/50	131/55

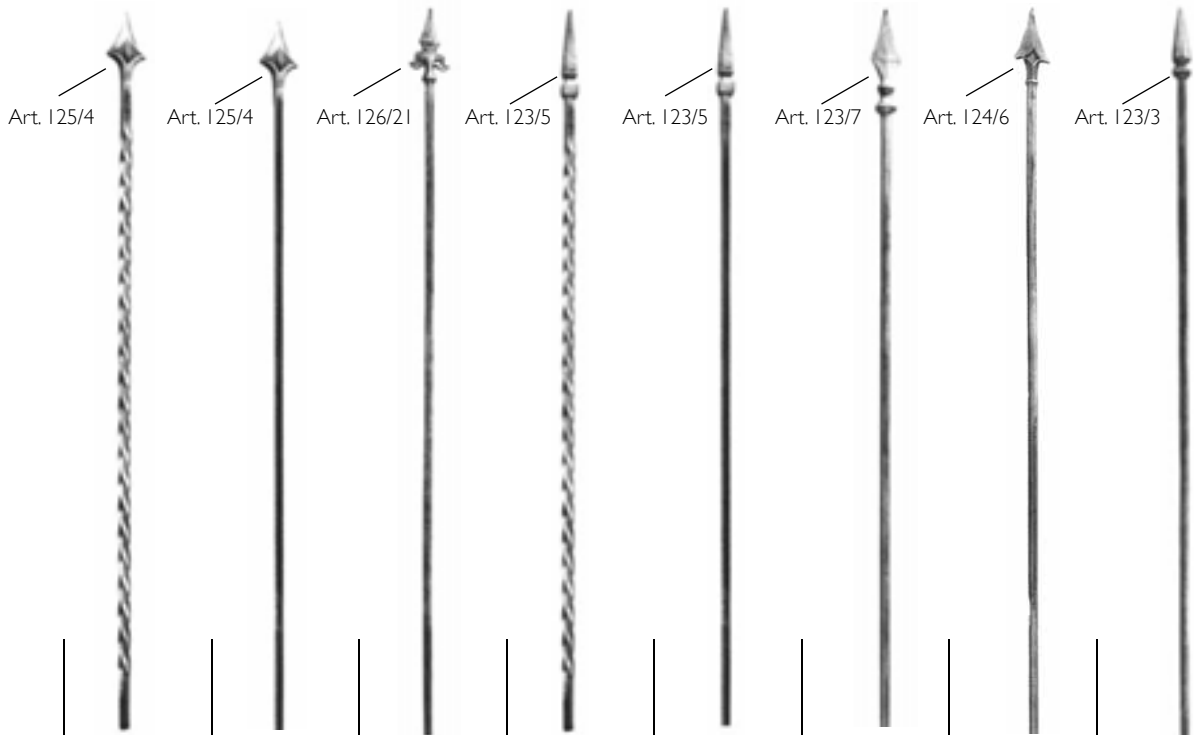

	Cod.art. Art.no.	Cod.art. Art.no.	Cod.art. Art.no.	Cod.art. Art.no.	Cod.art. Art.no.	Cod.art. Art.no.	Cod.art. Art.no.	Cod.art. Art.no.
H	Φ 16 x 16 mm	Φ 16 x 16 mm	Ø 16 mm	Φ 16 x 16 mm	Φ 16 x 16 mm	Ø 18 mm	Ø 16 mm	Ø 18 mm
800 mm	131/31	131/34	131/43	131/37	131/40	131/56	132/37	132/11
900 mm	131/32	131/35	131/44	131/38	131/41	131/57	132/38	132/12
1000 mm	131/33	131/36	131/45	131/39	131/42	131/58	132/39	132/13

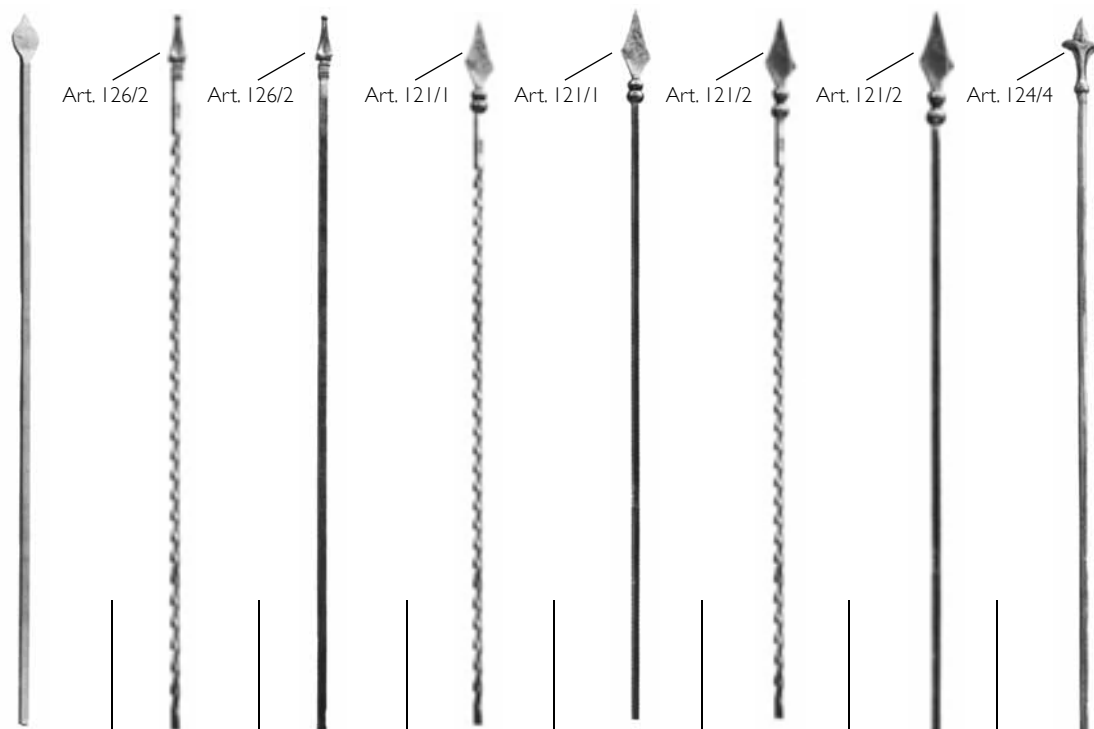

	Cod.art. Art.no.	Cod.art. Art.no.	Cod.art. Art.no.	Cod.art. Art.no.	Cod.art. Art.no.	Cod.art. Art.no.	Cod.art. Art.no.	Cod.art. Art.no.
H	Φ 12 x 12 mm	Φ 14 x 14 mm	Φ 14 x 14 mm	Φ 12 x 12 mm	Φ 12 x 12 mm	Φ 12 x 12 mm	Φ 12 x 12 mm	Ø 16 mm
800 mm	130/66	131/1	131/6	131/11	131/16	131/21	131/26	-
900 mm	130/67	131/2	131/7	131/12	131/17	131/22	131/27	-
1000 mm	130/68	131/3	131/8	131/13	131/18	131/23	131/28	132/24
1200 mm	130/69	131/4	131/9	131/14	131/19	131/24	131/29	132/25
1500 mm	130/70	131/5	131/10	131/15	131/20	131/25	131/30	132/26



	Cod.art. Art.no.	Cod.art. Art.no.	Cod.art. Art.no.	Cod.art. Art.no.	Cod.art. Art.no.	Cod.art. Art.no.	Cod.art. Art.no.	Cod.art. Art.no.
H	Φ 12 x 12 mm	Φ 14 x 14 mm	Φ 12 x 12 mm	Φ 14 x 14 mm	Φ 12 x 12 mm	Φ 14 x 14 mm	Φ 12 x 12 mm	Φ 14 x 14 mm
900 mm	132/A/1	132/A/4	132/A/7	132/A/10	132/A/13	132/A/16	132/A/19	132/A/22
1200 mm	132/A/2	132/A/5	132/A/8	132/A/11	132/A/14	132/A/17	132/A/20	132/A/23
1500 mm	132/A/3	132/A/6	132/A/9	132/A/12	132/A/15	132/A/18	132/A/21	132/A/24

CAPOSALDI - NEWEL POSTS

Art. 42/B/5
 Φ 25 x 25 mm
 H 1000 mm

Art. 42/B/7
 Φ 30 x 30 mm
 H 1000 mm

Art. 42/B/6
 Φ 25 x 25 mm
 H 1200 mm

Art. 42/B/8
 Φ 30 x 30 mm
 H 1200 mm

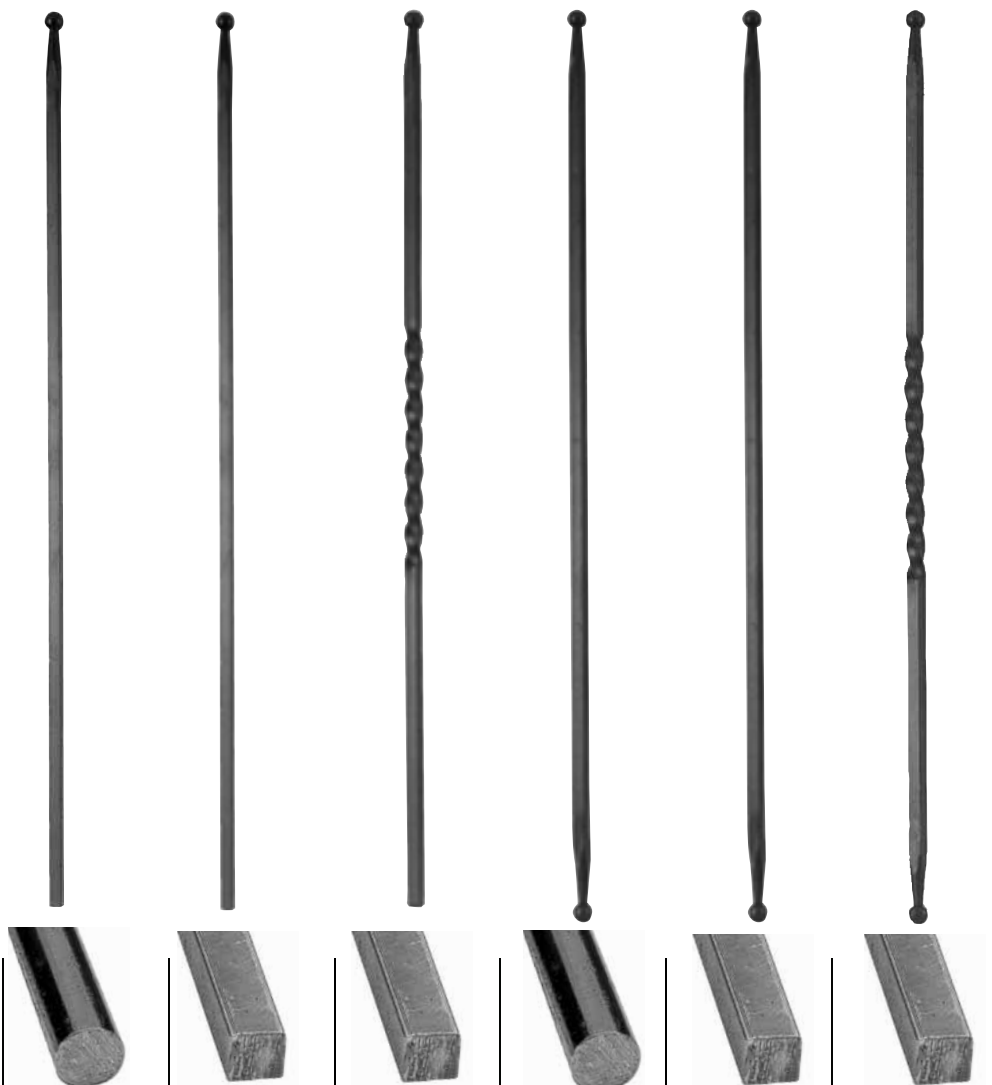

H	Sez./Sect./ Φ -diam.	Cod.art./Art.no.	Cod.art./Art.no.	Cod.art./Art.no.	Cod.art./Art.no.	Cod.art./Art.no.	Cod.art./Art.no.
200 mm	12 mm	118/C/66	118/C/63	-	-	-	-
	14 mm	118/C/67	118/C/64	-	-	-	-
	16 mm	118/C/68	118/C/65	-	-	-	-
700 mm	12 mm	118/C/45	118/C/9	118/C/5	118/C/37	118/C/21	118/C/14
	14 mm	118/C/48	118/C/11	118/C/7	118/C/40	118/C/3	118/C/1
	16 mm	118/C/48/T16	-	118/C/7/Q16	118/C/40/T16	118/C/106	118/C/11/Q16
900 mm	12 mm	118/C/46	118/C/10	118/C/6	118/C/38	118/C/22	118/C/15
	14 mm	118/C/49	118/C/12	118/C/8	118/C/41	118/C/4	118/C/2
	16 mm	118/C/49/T16	118/C/34	118/C/29	118/C/43	118/C/24	118/C/17
1000 mm	12 mm	118/C/47	118/C/33	118/C/28	118/C/39	118/C/23	118/C/16
	14 mm	118/C/50	118/C/32	118/C/27	118/C/42	118/C/20	118/C/13
	16 mm	118/C/51	118/C/35	118/C/30	118/C/44	118/C/25	118/C/18
1200 mm	12 mm	118/C/58	118/C/53	118/C/28/1200	118/C/39/1200	118/C/23/1200	118/C/16/1200
	14 mm	118/C/60	118/C/55	118/C/27/1200	118/C/42/1200	118/C/20/1200	118/C/13/1200
	16 mm	118/C/52	118/C/36	118/C/31	118/C/44/1200	118/C/26	118/C/19
1500 mm	12 mm	118/C/59	118/C/54	-	-	-	-
	14 mm	118/C/61	118/C/56	-	-	-	-
	16 mm	118/C/62	118/C/57	-	-	-	-

**QUALSIASI
 ALTEZZA
 SU RICHIESTA
 SPECIAL HEIGHT
 UPON REQUEST**

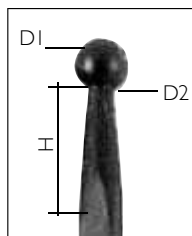

Sez./Sect.	Φ 12 mm	Φ 14 mm	Φ 16 mm	Φ 12 mm	Φ 14 mm	Φ 16 mm
H	31 mm	37 mm	45 mm	28 mm	28 mm	25,6 mm
D1	16 mm	18 mm	20 mm	12 mm	16 mm	18 mm
D2	7,6 mm	9,8 mm	9,9 mm	6,1 mm	6,9 mm	9,7 mm

A richiesta anche con pallina piccola / Upon request with little sphere

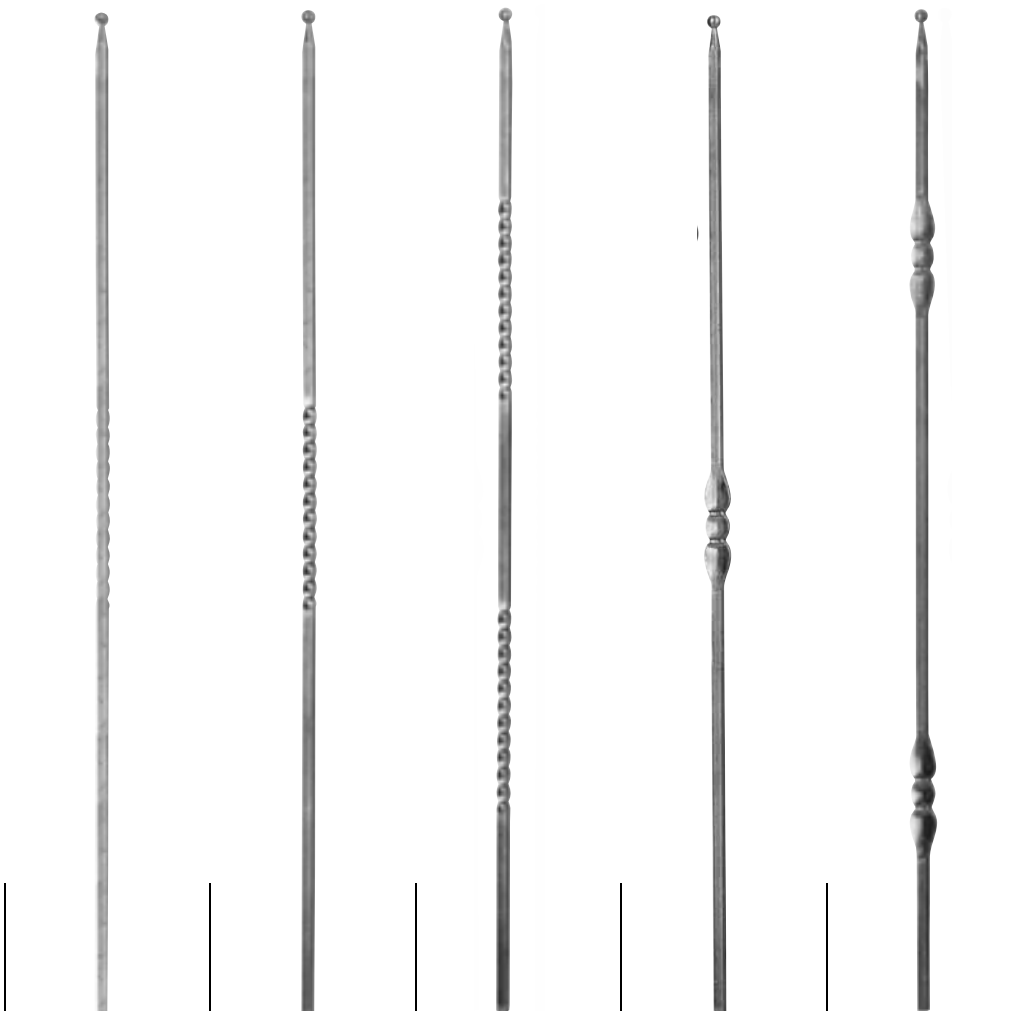

H	Sez-Sect.	Cod.art./Art.no.	Cod.art./Art.no.	Cod.art./Art.no.	Cod.art./Art.no.	Cod.art./Art.no.
1000 mm	Φ 12 x 12 mm	1759/36	1759/27	1759/19	1759/10	1759/1
	Φ 14 x 14 mm	1759/39	1759/30	1759/22	1759/13	1759/4
	Φ 16 x 16 mm	1759/42	1759/33	1759/24	1759/16	1759/7
1200 m	Φ 12 x 12 mm	1759/37	1759/28	1759/20	1759/11	1759/2
	Φ 14 x 14 mm	1759/40	1759/31	1759/48	1759/14	1759/5
	Φ 16 x 16 mm	1759/43	1759/34	1759/25	1759/17	1759/8
1500 m	Φ 12 x 12 mm	1759/38	1759/29	1759/21	1759/12	1759/3
	Φ 14 x 14 mm	1759/41	1759/32	1759/23	1759/15	1759/6
	Φ 16 x 16 mm	1759/44	1759/35	1759/26	1759/18	1759/9

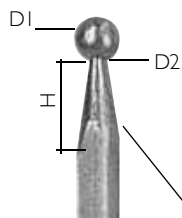

Sez./Sect.	Φ 12 mm	Φ 14 mm	Φ 16 mm	Ø 12 mm	Ø 14 mm	Ø 16 mm
H	36 mm	45,5 mm	45,5 mm			
D1	16 mm	18 mm	21 mm			
D2	7,5 mm	6,4 mm	11,6 mm			

Dimensione delle sfere
Spheres dimension:
 Φ 12 x 12 mm
 Sfera/Sphere Ø 16 mm
 Φ 14 x 14 mm
 Sfera/Sphere Ø 18 mm
 Φ 16 x 16 mm
 Sfera/Sphere Ø 21 mm



PALETTI per RECINZIONE - PICKETS for FENCINGS

NOVITÀ NOVELTIES

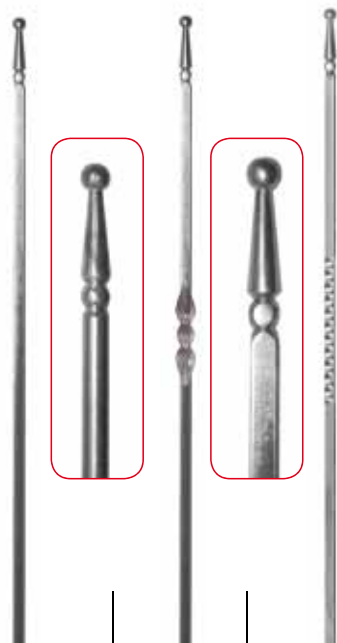
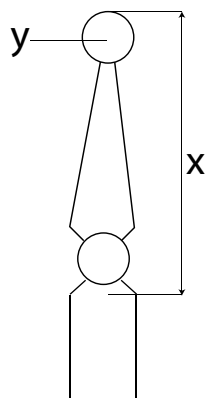

Sez. / Sect.	H	Art.	Art.	Art.
Ø 12 mm x = 68 mm y = Ø 13 mm	150 mm	1758/1	-	-
	1000 mm	1758/2	1758/5	-
	1200 mm	1758/3	1758/6	-
	1500 mm	1758/4	1758/7	-
Ø 14 mm x = 80 mm y = Ø 16 mm	150 mm	1758/8	-	-
	1000 mm	1758/9	1758/12	-
	1200 mm	1758/10	1758/13	-
	1500 mm	1758/11	1758/14	-
Ø 16 mm x = 91 mm y = Ø 18 mm	150 mm	1758/15	-	-
	1000 mm	1758/16	1758/19	-
	1200 mm	1758/17	1758/20	-
	1500 mm	1758/18	1758/21	-
Ø 18 mm	150 mm	-	-	-
	1000 mm	-	-	-
	1200 mm	-	-	-
	1500 mm	-	-	-

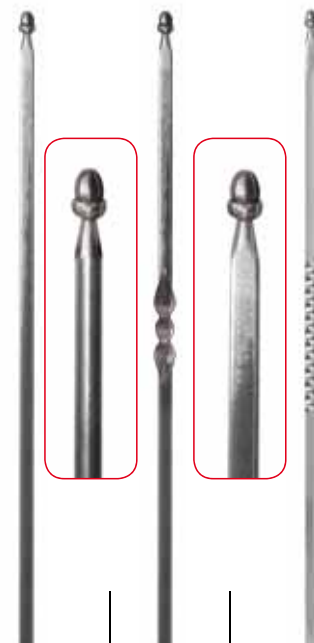
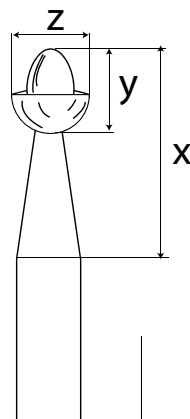

Sez. / Sect.	H	Art.	Art.	Art.
Ø 12 mm x = 66 mm y = Ø 21 mm z = Ø 15 mm	150 mm	1757/1	-	-
	1000 mm	1757/2	1757/5	-
	1200 mm	1757/3	1757/6	-
	1500 mm	1757/4	1757/7	-
Ø 14 mm x = 55 mm y = Ø 23 mm z = Ø 16 mm	150 mm	1757/8	-	-
	1000 mm	1757/9	1757/12	-
	1200 mm	1757/10	1757/13	-
	1500 mm	1757/11	1757/14	-
Ø 16 mm x = 55 mm y = Ø 24 mm z = Ø 18 mm	150 mm	1757/15	-	-
	1000 mm	1757/16	1757/19	-
	1200 mm	1757/17	1757/20	-
	1500 mm	1757/18	1757/21	-
Ø 18 mm x = 60 mm y = Ø 29 mm z = Ø 20 mm	150 mm	1757/22	-	-
	1000 mm	1757/23	1757/26	-
	1200 mm	1757/24	1757/27	-
	1500 mm	1757/25	1757/28	-

Ø 10 x 10 mm x = 68 mm y = Ø 13 mm	150 mm	1758/22	-	-
	1000 mm	1758/23	1758/26	1758/29
	1200 mm	1758/24	1758/27	1758/30
	1500 mm	1758/25	1758/28	1758/31
Ø 12 x 12 mm x = 80 mm y = Ø 16 mm	150 mm	1758/32	-	-
	1000 mm	1758/33	1758/36	1758/39
	1200 mm	1758/34	1758/37	1758/40
	1500 mm	1758/35	1758/38	1758/41
Ø 14 x 14 mm x = 91 mm y = Ø 18 mm	150 mm	1758/42	-	-
	1000 mm	1758/43	1758/46	1758/49
	1200 mm	1758/44	1758/47	1758/50
	1500 mm	1758/45	1758/48	1758/51
Ø 16 x 16 mm	150 mm	-	-	-
	1000 mm	-	-	-
	1200 mm	-	-	-
	1500 mm	-	-	-
Ø 14 x 8 mm	150 mm	1758/52	-	-
	1000 mm	1758/53	1758/56	1758/59
	1200 mm	1758/54	1758/57	1758/60
	1500 mm	1758/55	1758/58	1758/61

Ø 10 x 10 mm x = 66 mm y = Ø 21 mm z = Ø 14 mm	150 mm	1757/29	-	-
	1000 mm	1757/30	1757/33	1757/36
	1200 mm	1757/31	1757/34	1757/37
	1500 mm	1757/32	1757/35	1757/38
Ø 12 x 12 mm x = 55 mm y = Ø 23 mm z = Ø 16 mm	150 mm	1757/39	-	-
	1000 mm	1757/40	1757/43	1757/46
	1200 mm	1757/41	1757/44	1757/47
	1500 mm	1757/42	1757/45	1757/48
Ø 14 x 14 mm x = 55 mm y = Ø 24 mm z = Ø 18 mm	150 mm	1757/49	-	-
	1000 mm	1757/50	1757/53	1757/56
	1200 mm	1757/51	1757/54	1757/57
	1500 mm	1757/52	1757/55	1757/58
Ø 16 x 16 mm x = 60 mm y = Ø 29 mm z = Ø 20 mm	150 mm	1757/59	-	-
	1000 mm	1757/60	1757/63	1757/66
	1200 mm	1757/61	1757/64	1757/67
	1500 mm	1757/62	1757/65	1757/68
Ø 14 x 8 mm	150 mm	1757/69	-	-
	1000 mm	1757/70	1757/73	1757/76
	1200 mm	1757/71	1757/74	1757/77
	1500 mm	1757/72	1757/75	1757/78



	Cod.art. Art.no.	Cod.art. Art.no.	Cod.art. Art.no.	Cod.art. Art.no.	Cod.art. Art.no.	Cod.art. Art.no.	Cod.art. Art.no.	Cod.art. Art.no.
H	Ø 12 mm	Ø 14 mm	Ø 12 mm	Ø 14 mm	Ø 12 mm	Ø 14 mm	Ø 12 mm	Ø 14 mm
1000 mm	1259/21	1259/22	1259/5	1259/6	1258/21	1258/22	1258/5	1258/6
1200 mm	1259/23	1259/24	1259/7	1259/8	1258/23	1258/24	1258/7	1258/8



	Cod.art. Art.no.	Cod.art. Art.no.	Cod.art. Art.no.	Cod.art. Art.no.	Cod.art. Art.no.	Cod.art. Art.no.	Cod.art. Art.no.	Cod.art. Art.no.
H	Ø 12 mm	Ø 14 mm	Ø 12 mm	Ø 14 mm	Ø 12 mm	Ø 14 mm	Ø 12 mm	Ø 14 mm
1000 mm	1259/17	1259/18	-	-	1258/17	1258/18	-	-
1200 mm	1259/19	1259/20	-	-	1258/19	1258/20	-	-



	Cod.art. Art.no.	Cod.art. Art.no.	Cod.art. Art.no.	Cod.art. Art.no.	Cod.art. Art.no.	Cod.art. Art.no.	Cod.art. Art.no.	Cod.art. Art.no.
H	Ø 12 mm	Ø 14 mm	Ø 12 mm	Ø 14 mm	Ø 12 mm	Ø 14 mm	Ø 12 mm	Ø 14 mm
1000 mm	1259/13	1259/14	-	-	1258/13	1258/14	-	-
1200 mm	1259/15	1259/16	-	-	1258/15	1258/16	-	-

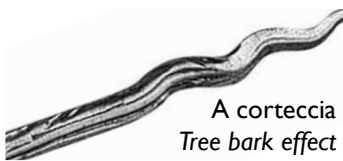

	Cod.art. Art.no.	Cod.art. Art.no.	Cod.art. Art.no.	Cod.art. Art.no.	Cod.art. Art.no.	Cod.art. Art.no.	Cod.art. Art.no.	Cod.art. Art.no.
H	Ø 12 mm	Ø 14 mm	Ø 12 mm	Ø 14 mm	Ø 12 mm	Ø 14 mm	Ø 12 mm	Ø 14 mm
1000 mm	-	-	1259/1	1259/2	-	-	1258/1	1258/2
1200 mm	-	-	1259/3	1259/4	-	-	1258/3	1258/4



	Cod.art. Art.no.	Cod.art. Art.no.	Cod.art. Art.no.	Cod.art. Art.no.	Cod.art. Art.no.	Cod.art. Art.no.	Cod.art. Art.no.	Cod.art. Art.no.
H	Ø 12 mm	Ø 14 mm	Ø 12 mm	Ø 14 mm	Ø 12 mm	Ø 14 mm	Ø 12 mm	Ø 14 mm
1000 mm	1259/9	1259/10	-	-	1258/9	1258/10	-	-
1200 mm	1259/11	1259/12	-	-	1258/11	1258/12	-	-

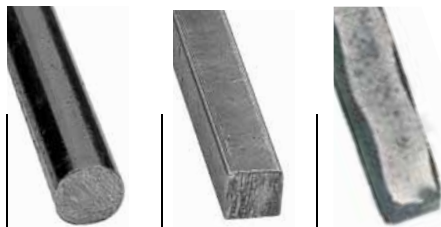

H	Sez.Sect	Cod.art./Art.no.	Cod.art./Art.no.	Cod.art./Art.no.
300 mm	12 mm	132/C/18	132/C/12	-
	14 mm	132/C/19	132/C/13	-
	16 mm	132/C/20	132/C/14	-
	18 mm	-	-	-
	20 mm	132/C/21	132/C/15	-
	22 mm	-	-	-
	25 mm	132/C/22	132/C/16	-
	30 mm	132/C/23	132/C/17	-
900 mm	12 mm	132/C/1	132/B/37	132/B/46
	14 mm	132/C/4	132/B/40	132/B/49
	16 mm	132/C/7	132/B/43	132/B/52
	18 mm	-	-	-
	20 mm	-	-	-
	22 mm	-	-	-
	25 mm	-	-	-
	30 mm	-	-	-
1000 mm	12 mm	-	-	-
	14 mm	132/D/11	132/D/1	-
	16 mm	132/D/13	132/D/3	-
	18 mm	132/D/15	132/D/5	-
	20 mm	132/D/18	132/D/8	-
	22 mm	-	-	-
	25 mm	-	-	-
	30 mm	-	-	-
1200 mm	12 mm	132/C/2	132/B/38	132/B/47
	14 mm	132/C/5	132/B/41	132/B/50
	16 mm	132/C/8	132/B/44	132/B/53
	18 mm	-	-	-
	20 mm	-	-	-
	22 mm	-	-	-
	25 mm	-	-	-
	30 mm	-	-	-
1500 mm	12 mm	132/C/3	132/B/39	132/B/48
	14 mm	132/C/6	132/B/42	132/B/51
	16 mm	132/C/9	132/B/45	132/B/54
	18 mm	132/D/16	132/D/6	-
	20 mm	132/D/19	132/D/9	-
	22 mm	132/C/28	-	-
	25 mm	132/C/10	132/C/25	-
	30 mm	-	-	-
2000 mm	12 mm	-	-	-
	14 mm	132/D/12	132/D/2	-
	16 mm	132/D/14	132/D/4	-
	18 mm	132/D/17	132/D/7	132/B/83
	20 mm	132/D/20	132/D/10	132/B/84
	22 mm	132/C/29	-	-
	25 mm	-	-	-
	30 mm	-	-	-



ARTEFERRO



QUALSIASI ALTEZZA
SU RICHIESTA

SPECIAL HEIGHT
UPON REQUEST



H	Sez.Sect	Cod.art./Art.no.	Cod.art./Art.no.
900 mm	12 mm	132/B/55	132/B/64
	14 mm	132/B/58	132/B/67
	16 mm	132/B/61	132/B/70
1200 mm	12 mm	132/B/56	132/B/65
	14 mm	132/B/59	132/B/68
	16 mm	132/B/62	132/B/71
1500 mm	12 mm	132/B/57	132/B/66
	14 mm	132/B/60	132/B/69
	16 mm	132/B/63	132/B/72
2000 mm	18 mm	132/B/85	132/B/87
	20 mm	132/B/86	132/B/88

QUALSIASI ALTEZZA
SU RICHIESTA

SPECIAL HEIGHT
UPON REQUEST

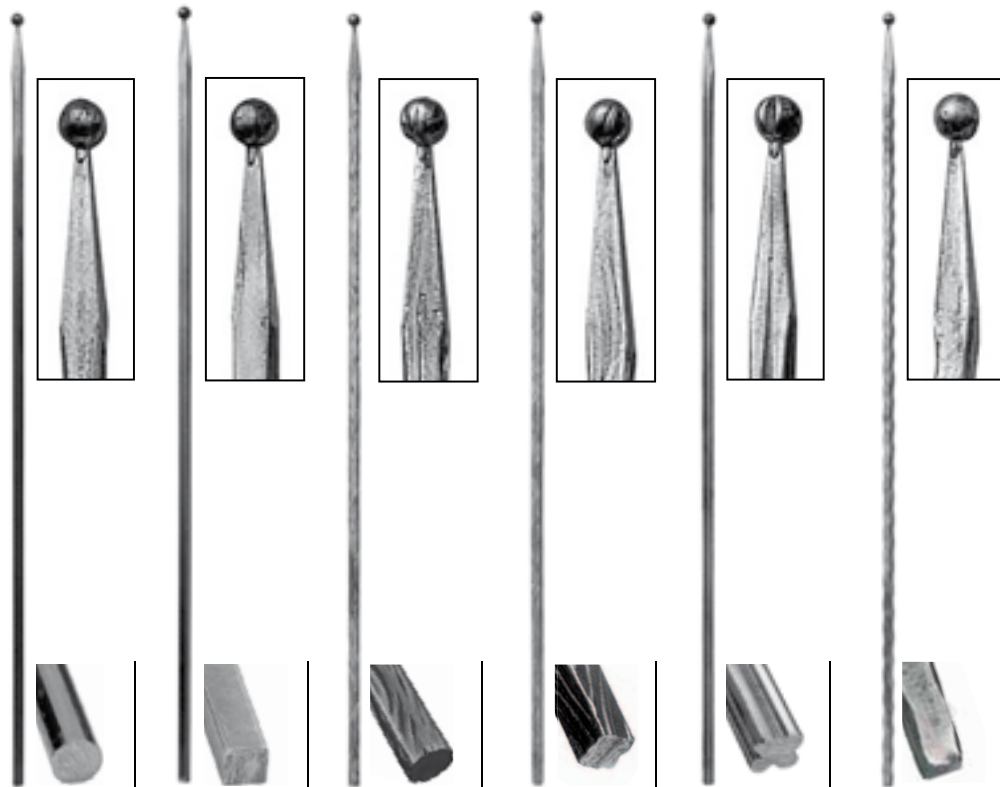

H	Sez.Sect	Cod.art./Art.no.	Cod.art./Art.no.	Cod.art./Art.no.	Cod.art./Art.no.	Cod.art./Art.no.	Cod.art./Art.no.
1000 mm	12 x 12 mm	1254/5	1254/21	1254/1	1254/13	1254/9	1254/17
	14 x 14 mm	1254/6	1254/22	1254/2	1254/14	1254/10	1254/18
1200 mm	Φ 12 x 12 mm	1254/7	1254/23	1254/3	1254/15	1254/11	1254/19
	Φ 14 x 14 mm	1254/8	1254/24	1254/4	1254/16	1254/12	1254/20



ARTEFERRO



- | | | |
|-----------------------------------------------|-----------------------------------------------|-----------------------------------------------|
| Art. 1148/32
40 x 40 x 3,5 mm
H 1000 mm | Art. 1148/30
40 x 40 x 3,5 mm
H 1000 mm | Art. 1148/28
40 x 40 x 3,5 mm
H 1000 mm |
| Art. 1148/33
50 x 50 x 5 mm
H 1000 mm | Art. 1148/31
50 x 50 x 5 mm
H 1000 mm | Art. 1148/29
50 x 50 x 5 mm
H 1000 mm |

PALETTI per RECINZIONE - PICKETS for FENCINGS



Dimensione delle medaglie
 Medal dimension:
 Ø 12 x 12 mm
 Medaglia/Medal
 Ø 32 mm
 Ø 14 x 14 mm
 Medaglia/Medal
 Ø 35 mm
 Ø 16 x 16 mm
 Medaglia/Medal
 Ø 42 mm

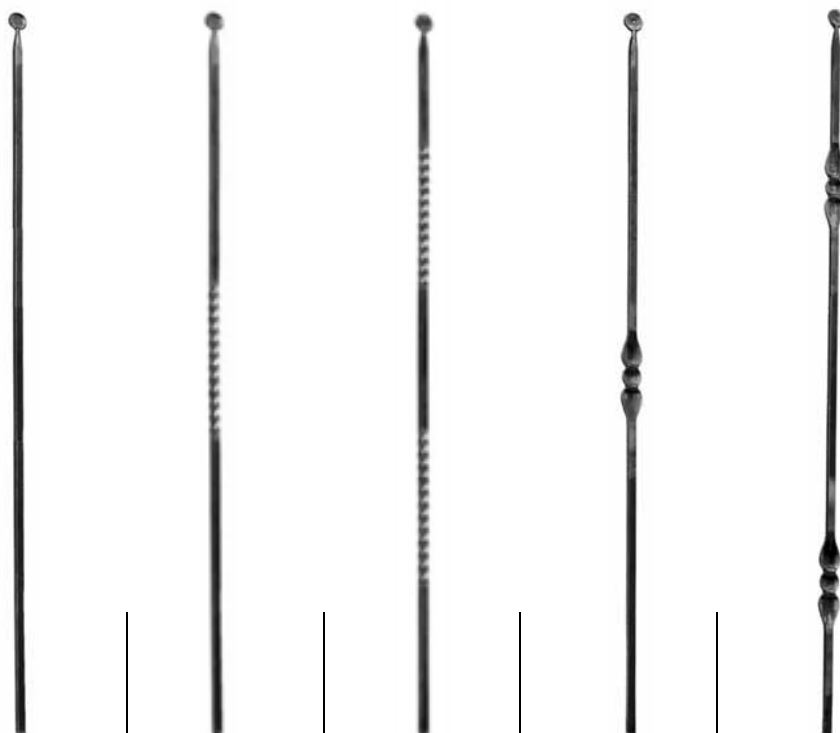

H	Sez-Sect.	Cod.art./Art.no.	Cod.art./Art.no.	Cod.art./Art.no.	Cod.art./Art.no.	Cod.art./Art.no.
1000 mm	Ø 12 x 12 mm	1754/36	1754/27	1754/19	1754/10	1754/1
	Ø 14 x 14 mm	1754/39	1754/30	1754/22	1754/13	1754/4
	Ø 16 x 16 mm	1754/42	1754/33	1754/24	1754/16	1754/7
1200 mm	Ø 12 x 12 mm	1754/37	1754/28	1754/20	1754/11	1754/2
	Ø 14 x 14 mm	1754/40	1754/31	1754/48	1754/14	1754/5
	Ø 16 x 16 mm	1754/43	1754/34	1754/25	1754/17	1754/8
1500 mm	Ø 12 x 12 mm	1754/38	1754/29	1754/21	1754/12	1754/3
	Ø 14 x 14 mm	1754/41	1754/32	1754/23	1754/15	1754/6
	Ø 16 x 16 mm	1754/44	1754/35	1754/26	1754/18	1754/9



Art. 179/1
 Ø 14 x 14 mm
 H 1200 mm

Art. 179/2
 Ø 14 x 14 mm
 H 2500 mm

QUALSIASI ALTEZZA
 SU RICHIESTA

SPECIAL HEIGHT
 UPON REQUEST

H	Sez-Sect.	Cod.art./Art.no.	Cod.art./Art.no.
800 mm	Ø 12 x 12 mm	1756/43	1756/37
	Ø 14 x 14 mm	1756/46	1756/40
1000 mm	Ø 12 x 12 mm	1756/44	1756/38
	Ø 14 x 14 mm	1756/47	1756/41
1200 mm	Ø 12 x 12 mm	1756/45	1756/39
	Ø 14 x 14 mm	1756/48	1756/42

QUALSIASI ALTEZZA
SU RICHIESTA

SPECIAL HEIGHT
UPON REQUEST

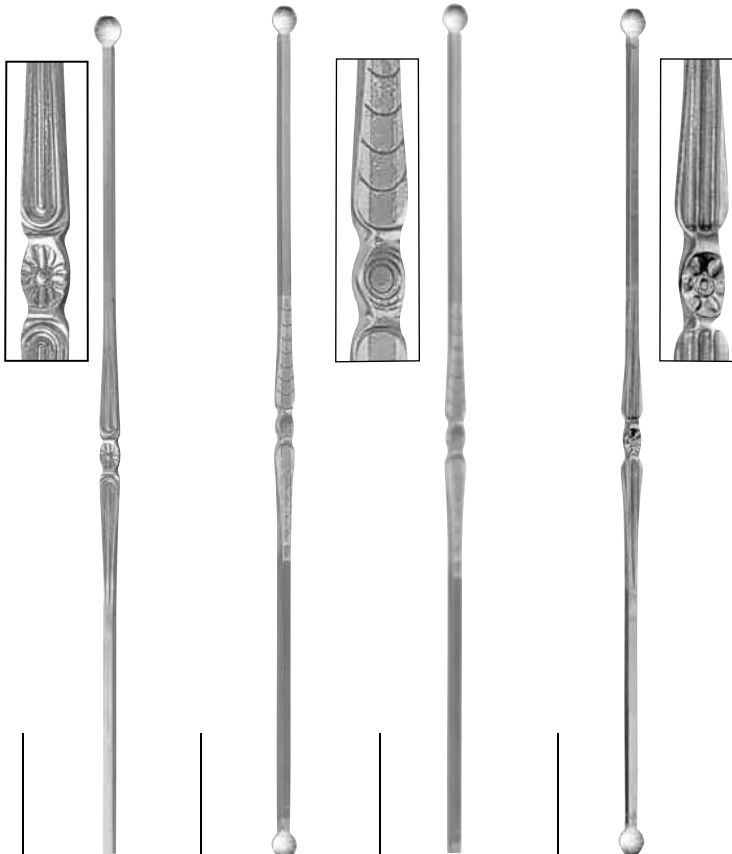

H	Sez-Sect.	Cod.art./Art.no.	Cod.art./Art.no.	Cod.art./Art.no.	Cod.art./Art.no.	Cod.art./Art.no.	Cod.art./Art.no.
1000 mm	Φ 12 × 12 mm	1756/1	1756/7	1756/13	1756/19	1756/25	1756/31
	Φ 14 × 14 mm	1756/4	1756/10	1756/16	1756/22	1756/28	1756/34
1000 mm	Φ 12 × 12 mm	1756/2	1756/8	1756/14	1756/20	1756/26	1756/32
	Φ 14 × 14 mm	1756/5	1756/11	1756/17	1756/23	1756/29	1756/35
1200 mm	Φ 12 × 12 mm	1756/3	1756/9	1756/15	1756/21	1756/27	1756/33
	Φ 14 × 14 mm	1756/6	1756/12	1756/18	1756/24	1756/30	1756/36

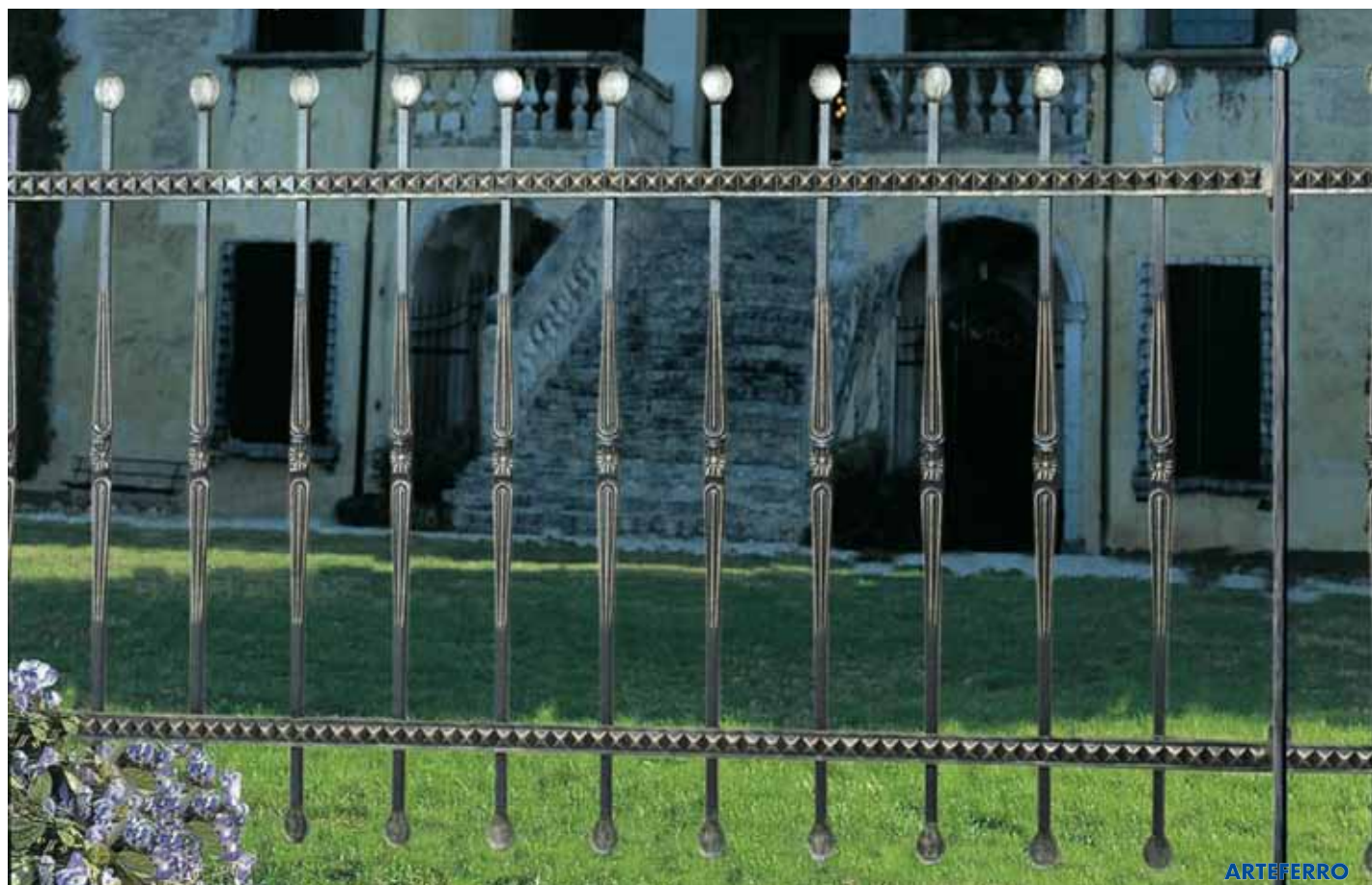

PALETTI per RECINZIONE - PICKETS for FENCINGS

ARTEFERRO

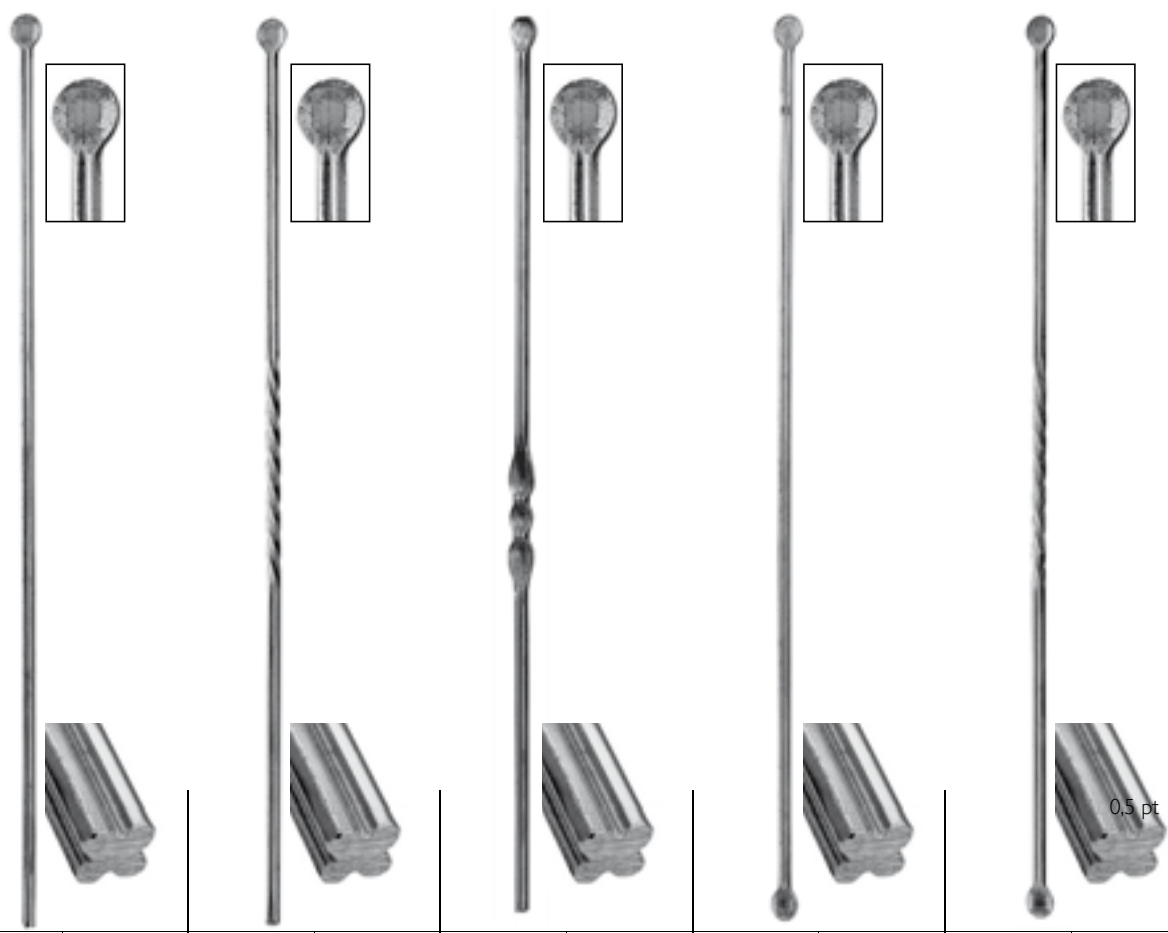

	Cod.art. Art.no.	Cod.art. Art.no.	Cod.art. Art.no.	Cod.art. Art.no.	Cod.art. Art.no.	Cod.art. Art.no.	Cod.art. Art.no.	Cod.art. Art.no.	Cod.art. Art.no.	Cod.art. Art.no.
H	Φ 12 mm	Φ 14 mm	Φ 12 mm	Φ 14 mm	Φ 12 mm	Φ 14 mm	Φ 12 mm	Φ 14 mm	Φ 12 mm	Φ 14 mm
1000 mm	1252/1	1252/2	1252/5	1252/6	1252/9	1252/10	1252/13	1252/14	1252/17	1252/18
1200 mm	1252/3	1252/4	1252/7	1252/8	1252/11	1252/12	1252/15	1252/16	1252/19	1252/20

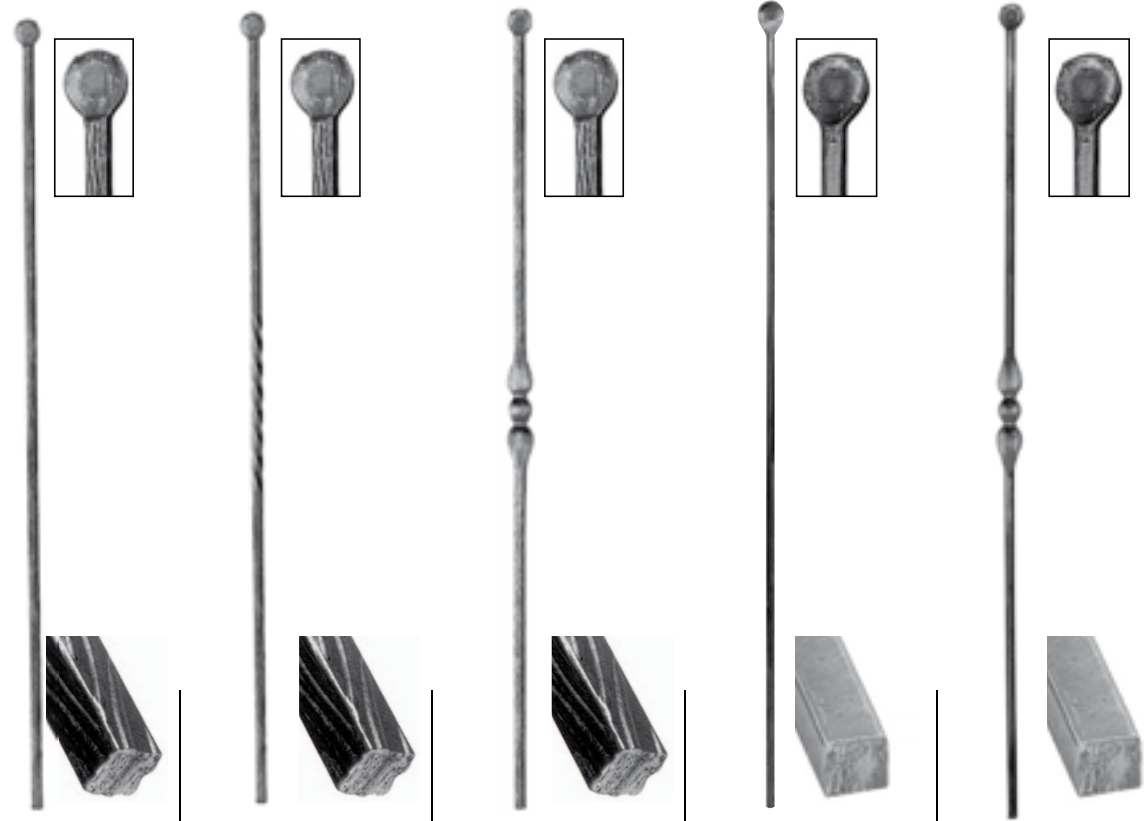

	Cod.art. Art.no.	Cod.art. Art.no.	Cod.art. Art.no.	Cod.art. Art.no.	Cod.art. Art.no.	Cod.art. Art.no.	Cod.art. Art.no.	Cod.art. Art.no.	Cod.art. Art.no.	Cod.art. Art.no.
H	Φ 12 mm	Φ 14 mm	Φ 12 mm	Φ 14 mm	Φ 12 mm	Φ 14 mm	Φ 12 mm	Φ 14 mm	Φ 12 mm	Φ 14 mm
1000 mm	1253/1	1253/2	1253/5	1253/6	1253/9	1253/10	GD43/1	1253/14	1253/17	1253/18
1200 mm	1253/3	1253/4	1253/7	1253/8	1253/11	1253/12	1253/15	1253/16	1253/19	1253/20

CAPOSALDI - NEWEL POSTS



ARTEFERRO

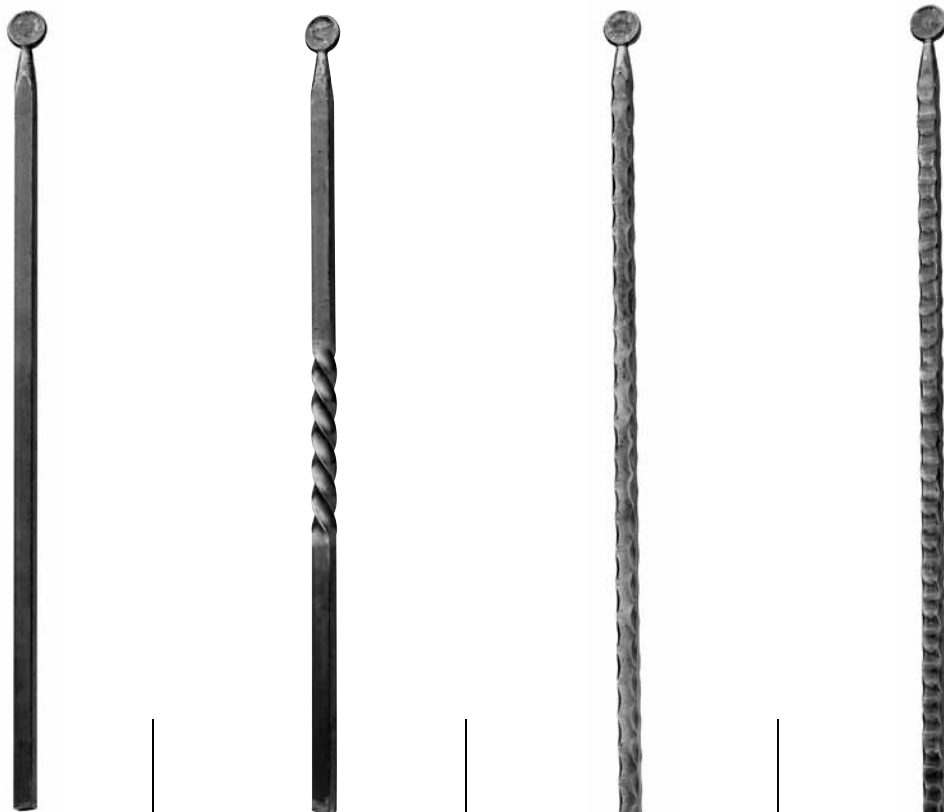

	Cod.art./Art.no.	Cod.art./Art.no.	Cod.art./Art.no.	Cod.art./Art.no.	Cod.art./Art.no.	Cod.art./Art.no.	Cod.art./Art.no.	Cod.art./Art.no.
H	Φ 25 x 25 mm	Φ 30 x 30 mm	Φ 25 x 25 mm	Φ 30 x 30 mm	Φ 25 x 25 mm	Φ 30 x 30 mm	Φ 25 x 25 mm	Φ 30 x 30 mm
1000 mm	1766/1	1766/3	1766/5	1766/7	1766/9	1766/11	1766/13	1766/15
1200 mm	1766/2	1766/4	1766/6	1766/8	1766/10	1766/12	1766/14	1766/16
1500 mm	GD111/1	-	-	-	-	-	-	-



ARTEFERRO

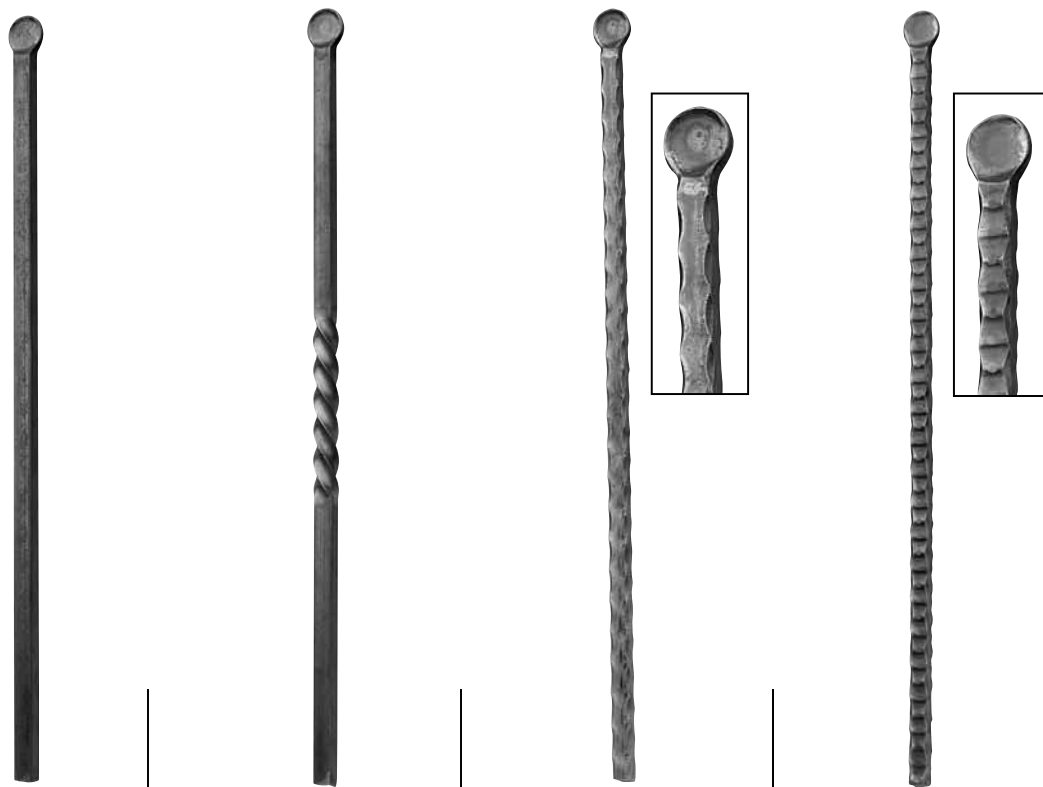

	Cod.art./Art.no.	Cod.art./Art.no.	Cod.art./Art.no.	Cod.art./Art.no.	Cod.art./Art.no.	Cod.art./Art.no.	Cod.art./Art.no.	Cod.art./Art.no.
H	Φ 25 x 25 mm	Φ 30 x 30 mm	Φ 25 x 25 mm	Φ 30 x 30 mm	Φ 25 x 25 mm	Φ 30 x 30 mm	Φ 25 x 25 mm	Φ 30 x 30 mm
1000 mm	1766/17	1766/19	1766/21	1766/23	1766/25	1766/27	1766/29	1766/31
1200 mm	1766/18	1766/20	1766/22	1766/24	1766/26	1766/28	1766/30	1766/32

PALETTI per RECINZIONE - PICKETS for FENCINGS

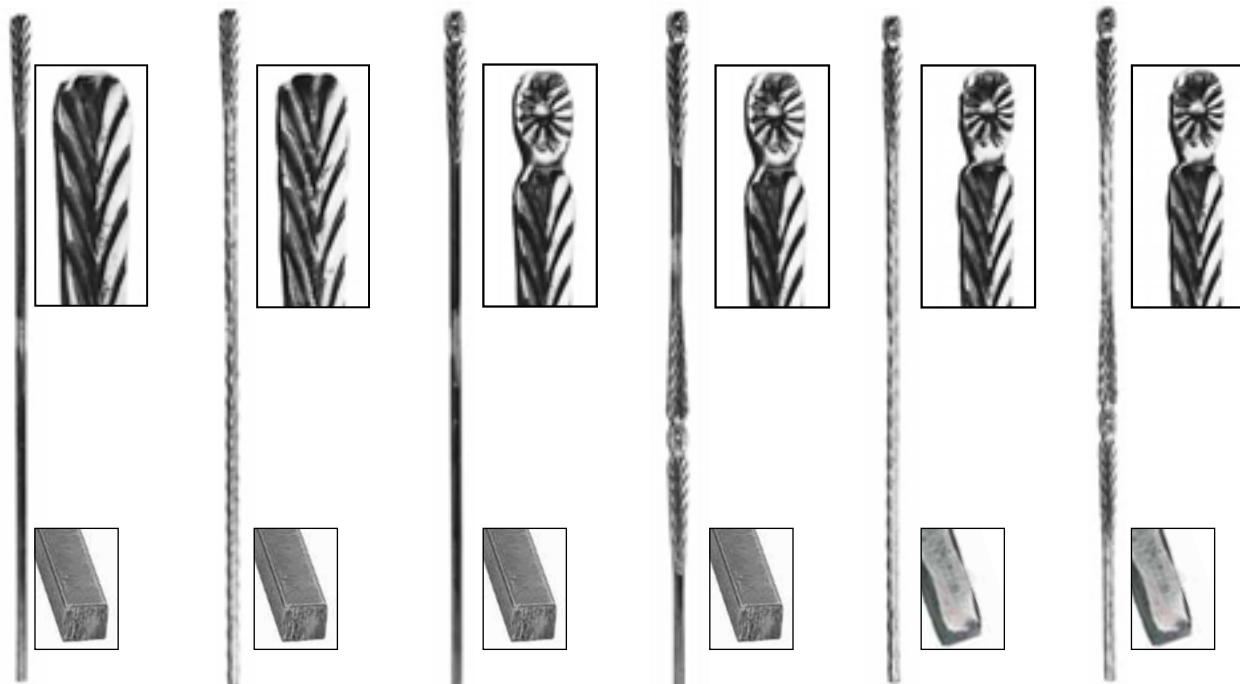

Art. 574/1
 Ø 14 mm
 H 900 mm

Art. 574/4
 Φ 12 x 12 mm
 H 900 mm

Art. 574/2
 Ø 14 mm
 H 900 mm

Art. 574/3
 Ø 14 mm
 H 900 mm

Art. 574/6
 Φ 12 x 12 mm
 H 900 mm

Art. 574/8
 Φ 12 x 12 mm
 H 900 mm

Art. 574/5
 Φ 14 x 14 mm
 H 900 mm

Art. 574/7
 Φ 14 x 14 mm
 H 900 mm

Art. 574/9
 Φ 14 x 14 mm
 H 900 mm

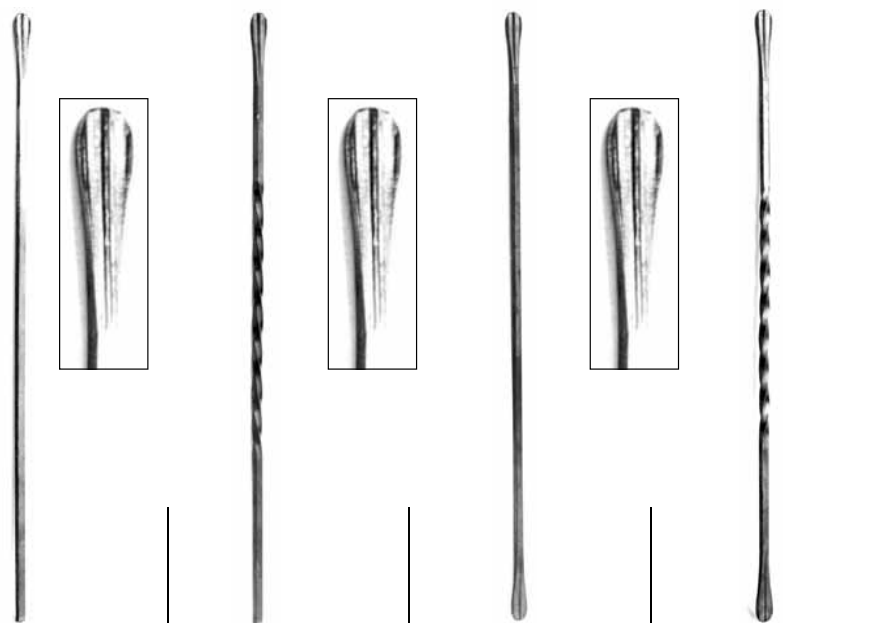

H	Sez.Sect	Cod.art./Art.no.	Cod.art./Art.no.	Cod.art./Art.no.	Cod.art./Art.no.
900 mm	Φ 12 x 12 mm	132/B/1	132/B/28	132/B/19	132/B/10
	Φ 14 x 14 mm	132/B/4	132/B/31	132/B/22	132/B/13
	Φ 16 x 16 mm	132/B/7	132/B/34	132/B/25	132/B/16
1200 mm	Φ 12 x 12 mm	132/B/2	132/B/29	132/B/20	132/B/11
	Φ 14 x 14 mm	132/B/5	132/B/32	132/B/23	132/B/14
	Φ 16 x 16 mm	132/B/8	132/B/35	132/B/26	132/B/17
1500 mm	Φ 12 x 12 mm	132/B/3	132/B/30	132/B/21	132/B/12
	Φ 14 x 14 mm	132/B/6	132/B/33	132/B/24	132/B/15
	Φ 16 x 16 mm	132/B/9	132/B/36	132/B/27	132/B/18
2000 mm	Φ 18 x 18 mm	132/B/73	132/B/79	132/B/77	132/B/75
	Φ 20 x 20 mm	132/B/74	132/B/80	132/B/78	132/B/76

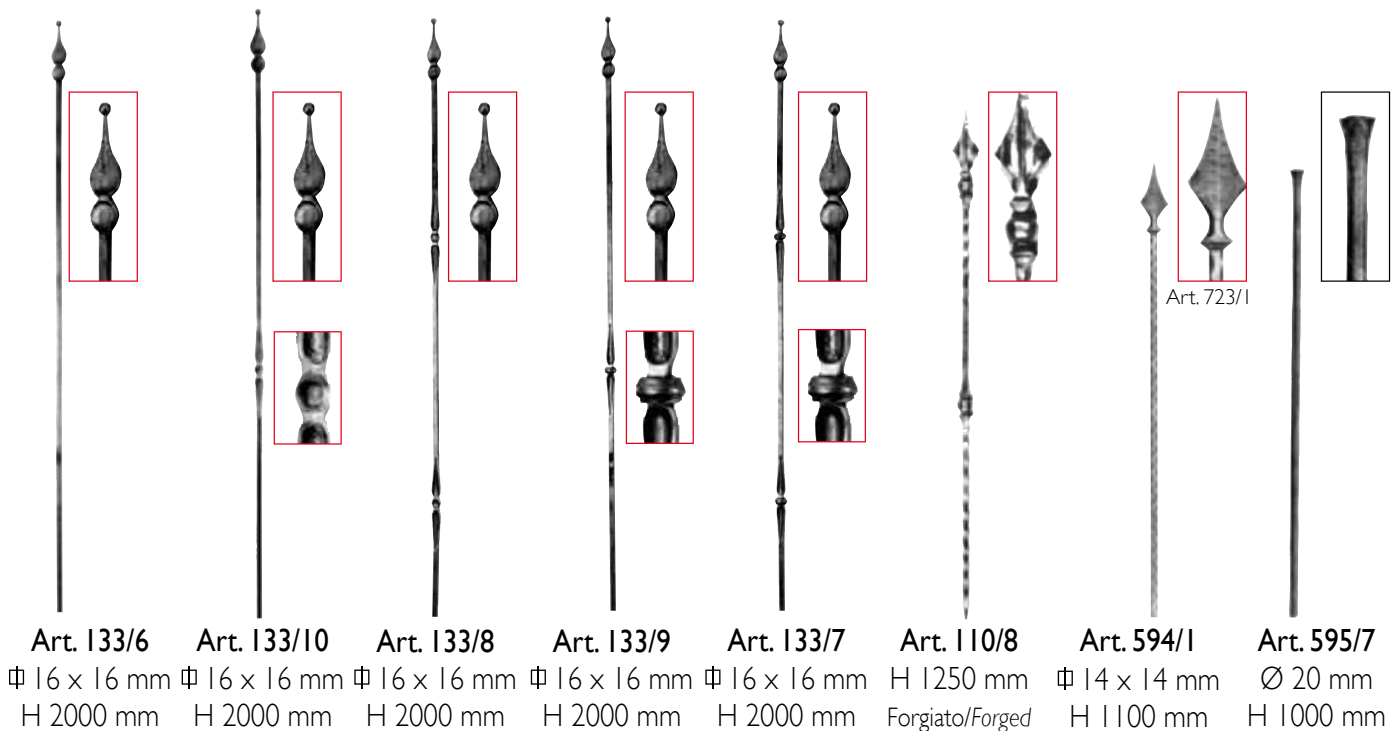

Art. 133/6 **Art. 133/10** **Art. 133/8** **Art. 133/9** **Art. 133/7** **Art. 110/8** **Art. 594/1** **Art. 595/7**
 Ø 16 x 16 mm Ø 16 x 16 mm Ø 16 x 16 mm Ø 16 x 16 mm Ø 16 x 16 mm H 1250 mm Ø 14 x 14 mm Ø 20 mm
 H 2000 mm H 2000 mm H 2000 mm H 2000 mm H 2000 mm Forgiato/Forged H 1100 mm H 1000 mm

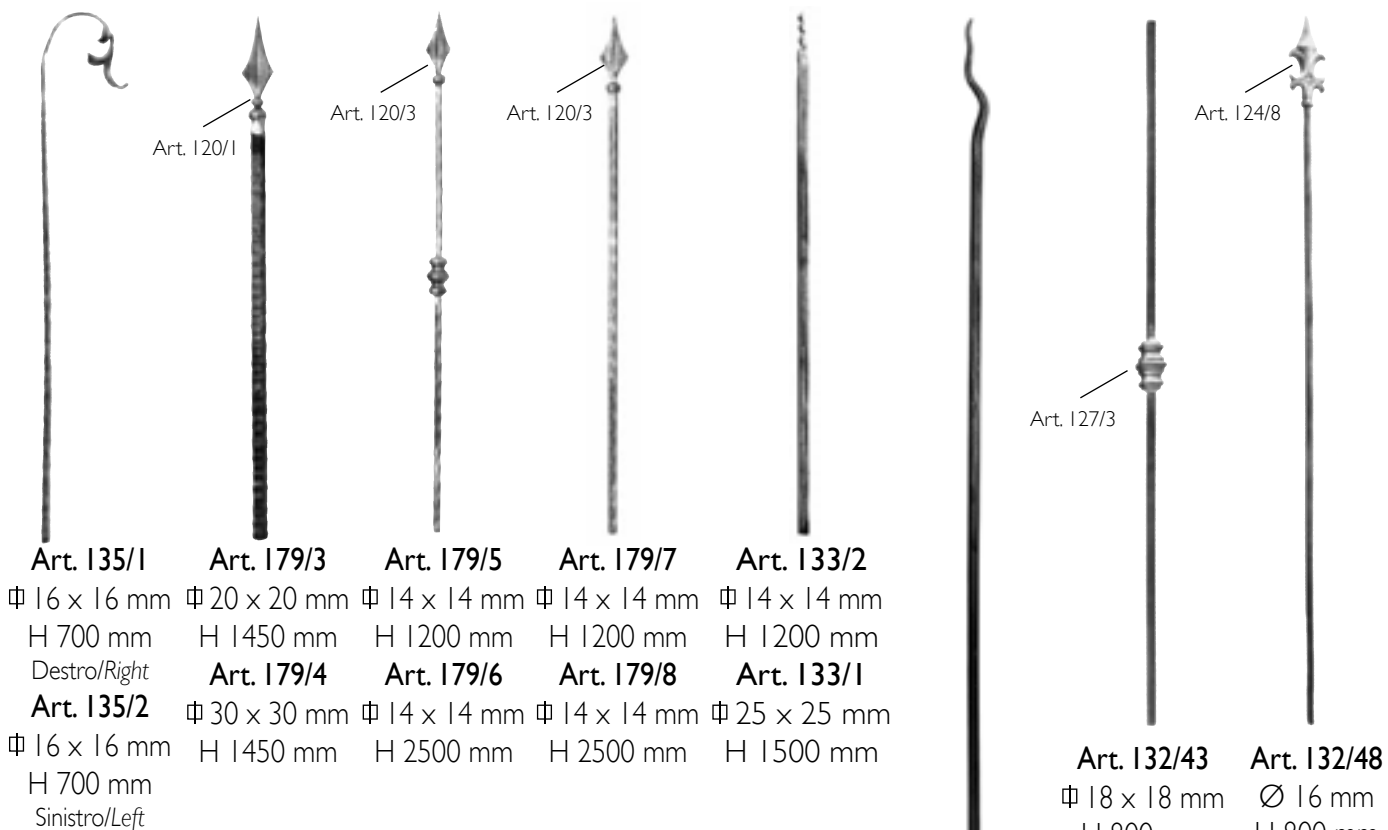

Art. 120/1 **Art. 120/3** **Art. 120/3** **Art. 127/3** **Art. 124/8**
Art. 135/1 **Art. 179/3** **Art. 179/5** **Art. 179/7** **Art. 133/2**
 Ø 16 x 16 mm Ø 20 x 20 mm Ø 14 x 14 mm Ø 14 x 14 mm Ø 14 x 14 mm
 H 700 mm H 1450 mm H 1200 mm H 1200 mm H 1200 mm
Destro/Right **Art. 179/4** **Art. 179/6** **Art. 179/8** **Art. 133/1**
Art. 135/2 Ø 30 x 30 mm Ø 14 x 14 mm Ø 14 x 14 mm Ø 25 x 25 mm
 H 700 mm H 1450 mm H 2500 mm H 2500 mm H 1500 mm
Sinistro/Left



Art. 1256/3 **Art. 132/43** **Art. 132/48**
 Ø 14 mm Ø 18 x 18 mm Ø 16 mm
 H 1000 mm H 800 mm H 800 mm
Art. 1256/1 **Art. 132/44** **Art. 132/49**
 Ø 20 mm Ø 18 x 18 mm Ø 16 mm
 H 1200 mm H 900 mm H 900 mm
Art. 1256/4 **Art. 132/45** **Art. 132/50**
 Ø 14 mm Ø 18 x 18 mm Ø 16 mm
 H 1200 mm H 1000 mm H 1000 mm
Art. 1256/2 **Art. 132/46** **Art. 132/51**
 Ø 20 mm Ø 18 x 18 mm Ø 16 mm
 H 1500 mm H 1500 mm H 1500 mm



QUALSIASI
ALTEZZA
SU RICHIESTA
SPECIAL HEIGHT
UPON REQUEST

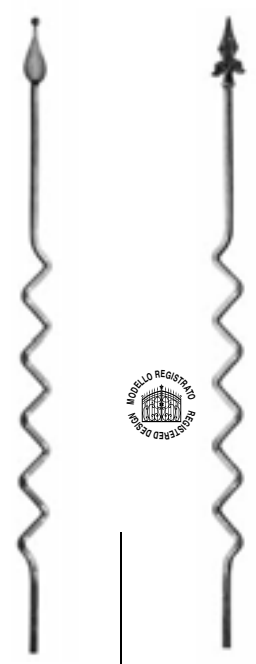

- Art. 134/23**
Φ 12 x 12 mm
H 800 mm
- Art. 134/26**
Φ 14 x 14 mm
H 800 mm
- Art. 134/24**
Φ 12 x 12 mm
H 1000 mm
- Art. 134/27**
Φ 14 x 14 mm
H 1000 mm
- Art. 134/25**
Φ 12 x 12 mm
H 1200 mm
- Art. 134/28**
Φ 14 x 14 mm
H 1200 mm
- Art. 134/A/11**
☐ 12 x 6 mm
H 1200 mm
- Art. 134/A/13**
Φ 12 x 12 mm
H 1200 mm
- Art. 134/A/15**
Φ 14 x 14 mm
H 1200 mm
- Art. 134/A/12**
☐ 12 x 6 mm
H 1500 mm
- Art. 134/A/14**
Φ 12 x 12 mm
H 1500 mm
- Art. 134/A/16**
Φ 14 x 14 mm
H 1500 mm
- Art. 1722/2**
Ø 10 mm
H 800 mm
- Art. 1722/3**
Ø 10 mm
H 1000 mm
- Art. 1722/4**
Ø 10 mm
H 1200 mm
- Art. 132/40**
Ø 16 mm
H 1000 mm
- Art. 132/41**
Ø 16 mm
H 1200 mm
- Art. 132/42**
Ø 16 mm
H 1500 mm

H	Sez.Sect	Cod.art./Art.no.	Cod.art./Art.no.
60 x 1000 mm	Φ 12 x 12 mm	1133/1	1133/13
	Φ 14 x 14 mm	1133/2	1133/14
	Ø 12 mm	1133/3	1133/15
	Ø 14 mm	1133/4	1133/16
60 x 1200 mm	Φ 12 x 12 mm	1133/5	1133/17
	Φ 14 x 14 mm	1133/6	1133/18
	Ø 12 mm	1133/7	1133/19
	Ø 14 mm	1133/8	1133/20
60 x 1500 mm	Φ 12 x 12 mm	1133/9	1133/21
	Φ 14 x 14 mm	1133/10	1133/22
	Ø 12 mm	1133/11	1133/23
	Ø 14 mm	1133/12	1133/24

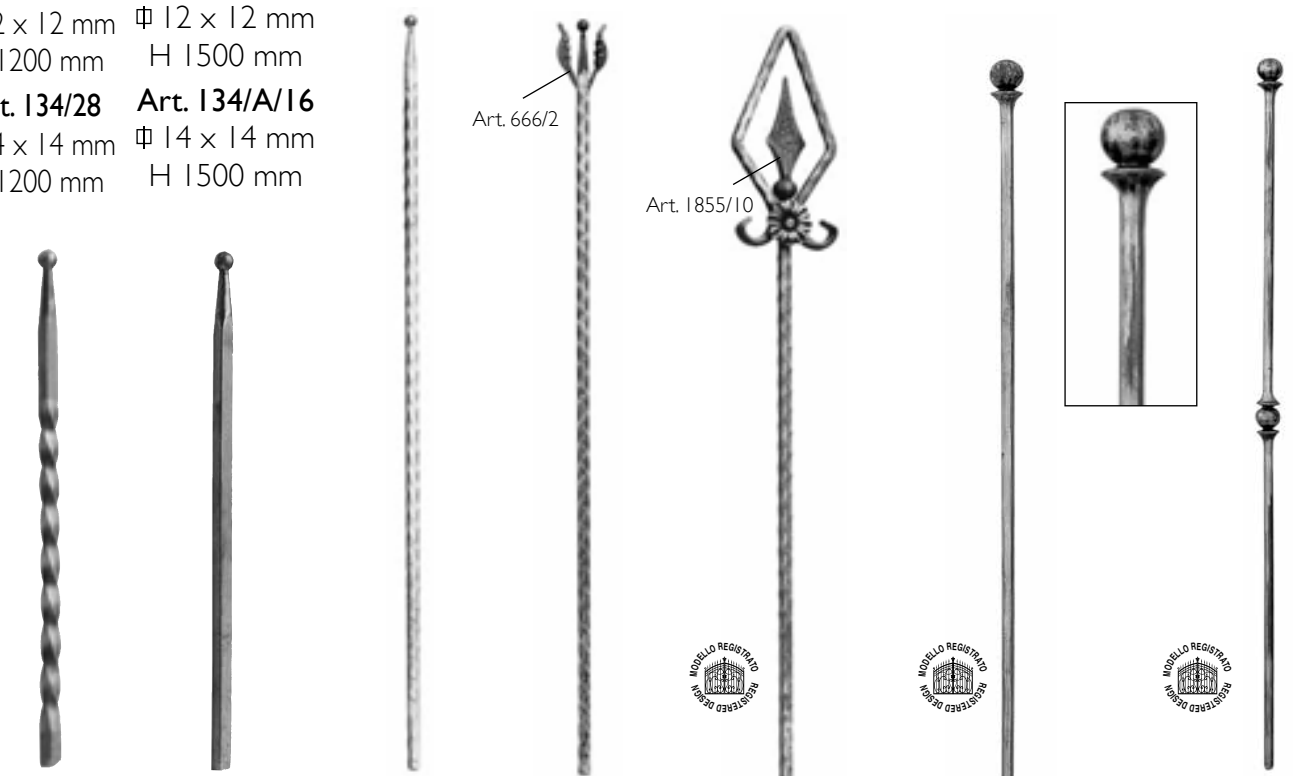

- Art. 88/Q/3**
Φ 12 x 12 mm
H 410 mm
- Art. 88/Q/2**
Φ 12 x 12 mm
H 370 mm
- Art. 594/4**
Φ 14 x 14 mm
H 1000 mm
- Art. 666/2**
Φ 14 x 14 mm
H 1100 mm
- Art. 1855/10**
Φ 14 x 14 mm
H 1100 mm
- Art. 594/3**
Φ 14 x 14 mm
H 1100 mm
- Art. 1184/1**
Ø 14 mm
H 100 mm
- Art. 1184/2**
Ø 14 mm
H 100 mm





Art. 593/9
 \varnothing 14 x 14 mm
 H 900 mm

Art. 1256/5
 \varnothing 25 mm
 H 900 mm

Art. 1256/6
 \varnothing 25 mm
 H 1300 mm



spigolato - hammered on edges



Art. 593/8
 \varnothing 14 x 14 mm
 H 900 mm

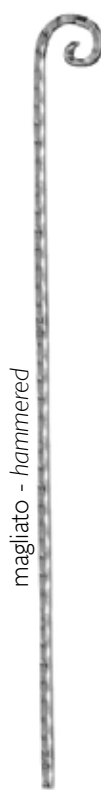

magliato - hammered

Art. 6048/5
 \varnothing 14 x 14 mm
 H 1000 mm



spigolato
 hammered on edges



Art. 595/18
 \varnothing 12 x 12 mm
 H 900 mm

Art. 595/19
 \varnothing 14 x 14 mm
 H 900 mm

Art. 595/6
 \varnothing 20 x 20 mm
 H 1100 mm

Art. 179/9
 \varnothing 30 x 30 mm
 H 2500 mm



Art. 595/16
 \varnothing 12 x 12 mm
 H 900 mm

Art. 595/17
 \varnothing 14 x 14 mm
 H 900 mm

Art. 595/5
 \varnothing 20 x 20 mm
 H 1100 mm

Art. 179/10
 \varnothing 30 x 30 mm
 H 2500 mm



Art. 180/49
 \varnothing 40 x 6 mm
 H 2500 mm

ARTEFERRO

PALETTI per RECINZIONE - PICKETS for FENCINGS

SECUFER®

vedi anche pagina 314

see also page 314



ARTEFERRO



Art. 610/25
 Φ 12 x 12 mm
 H 600 mm



Art. 610/4
 Φ 12 x 12 mm
 H 600 mm



Art. 610/11
 Φ 12 x 12 mm
 H 600 mm



Art. 610/18
 Φ 12 x 12 mm
 H 600 mm

Art. 610/26
 Φ 12 x 12 mm
 H 1000 mm

Art. 610/5
 Φ 12 x 12 mm
 H 1000 mm

Art. 610/12
 Φ 12 x 12 mm
 H 1000 mm

Art. 610/19
 Φ 12 x 12 mm
 H 1000 mm

Art. 610/27
 Φ 12 x 12 mm
 H 1200 mm

Art. 610/6
 Φ 12 x 12 mm
 H 1200 mm

Art. 610/13
 Φ 12 x 12 mm
 H 1200 mm

Art. 610/20
 Φ 12 x 12 mm
 H 1200 mm

Art. 610/28
 Φ 12 x 12 mm
 H 1500 mm

Art. 610/7
 Φ 12 x 12 mm
 H 1500 mm

Art. 610/14
 Φ 12 x 12 mm
 H 1500 mm

Art. 610/21
 Φ 12 x 12 mm
 H 1500 mm



Art. 610/29
 Φ 12 x 12 mm
 H 1000 mm



Art. 610/8
 Φ 12 x 12 mm
 H 1000 mm



Art. 610/15
 Φ 12 x 12 mm
 H 1000 mm



Art. 610/22
 Φ 12 x 12 mm
 H 1000 mm



TUBO - TUBE

Art. 613/1
 Φ 50 x 50 mm
 H 1100 mm
 Base 100 x 100 mm



TUBO - TUBE

Art. 613/2
 Φ 50 x 50 mm
 H 700 mm
 Base 100 x 100 mm

Art. 610/30
 Φ 12 x 12 mm
 H 1200 mm

Art. 610/9
 Φ 12 x 12 mm
 H 1200 mm

Art. 610/16
 Φ 12 x 12 mm
 H 1200 mm

Art. 610/23
 Φ 12 x 12 mm
 H 1200 mm

Art. 610/31
 Φ 12 x 12 mm
 H 1500 mm

Art. 610/10
 Φ 12 x 12 mm
 H 1500 mm

Art. 610/17
 Φ 12 x 12 mm
 H 1500 mm

Art. 610/24
 Φ 12 x 12 mm
 H 1500 mm

PALETTI per RECINZIONE - PICKETS for FENCINGS



CIMASE - OVERTHROWS

COMPENDIUM 2010



Art. 654/1
 Ø 30 x 8 mm
 H 1500 mm
 L 370 mm



Art. 653/1
 Ø 30 x 8 mm
 H 900 mm
 L 410 mm



Art. 653/2
 Ø 30 x 8 mm
 H 650 mm
 L 270 mm



Art. 653/4
 Ø 30 x 8 mm
 H 1500 mm
 L 360 mm



Art. 653/3
 Ø 30 x 8 mm
 H 1500 mm
 L 240 mm



Art. 654/2
 ▧ 30 × 8 mm
 H 1500 mm
 L 310 mm



Art. 654/4
 ▧ 30 × 8 mm
 H 1500 mm
 L 310 mm



Art. 654/3
 ▧ 30 × 8 mm
 H 1500 mm
 L 340 mm

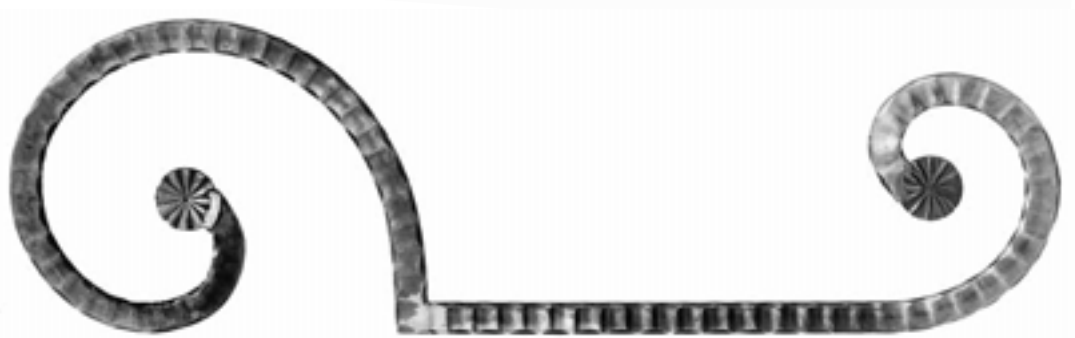

Art. 653/5
 ▧ 30 × 8 mm
 H 1500 mm
 L 310 mm



Art. 654/5
 Ø 60 mm
 ▧ 6 mm

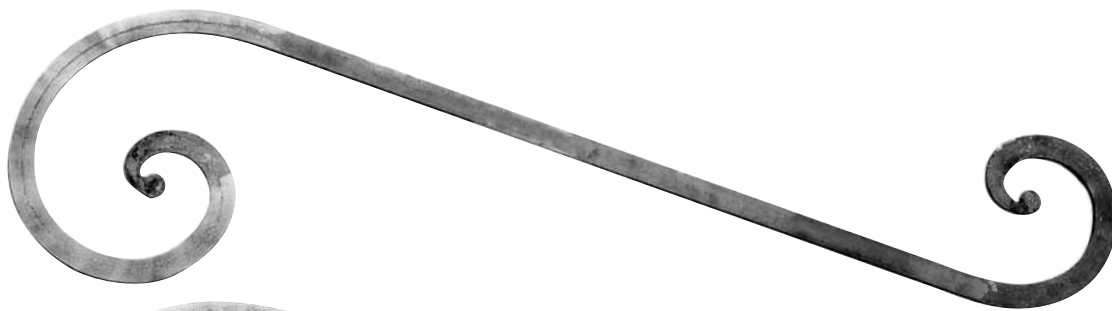

Art. 1311/1
 □ 35 × 8 mm
 H 420 mm
 L 1500 mm



Art. 1311/4
 □ 35 × 8 mm
 H 420 mm
 L 1000 mm



Art. 1311/3
 □ 35 × 8 mm
 H 240 mm
 L 1000 mm



Art. 1311/2
 □ 35 × 8 mm
 H 420 mm
 L 1500 mm



L 2000 mm
 H 500 mm



Art. 1827/5
 □ 30 × 8 mm
Art. 1827/6
 □ 40 × 8 mm

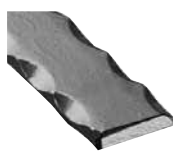

Art. 1827/1
 □ 30 × 8 mm
Art. 1827/2
 □ 40 × 8 mm

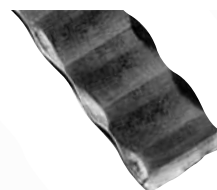

Art. 1827/3
 □ 30 × 8 mm
Art. 1827/4
 □ 40 × 8 mm



L 1200 mm
 H 250 mm



Art. 1827/11
 □ 30 × 8 mm
Art. 1827/12
 □ 40 × 8 mm

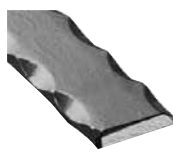

Art. 1827/7
 □ 30 × 8 mm
Art. 1827/8
 □ 40 × 8 mm

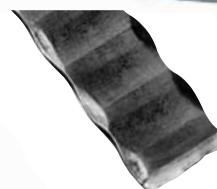

Art. 1827/9
 □ 30 × 8 mm
Art. 1827/10
 □ 40 × 8 mm



Art. NEW0013

Ø 16 x 6 mm
H 200 mm
L 770 mm



Art. NEW0014

Ø 16 x 6 mm
H 220 mm
L 830 mm

Art. NEW0015

Ø 16 x 6 mm
H 320 mm
L 1100 mm



Art. I281/2

Ø 16 x 8 mm
H 445 mm
L 1225 mm



Art. I281/1

Ø 16 x 8 mm
H 445 mm
L 1300 mm



Art. I16/D/2

Ø 20 x 6 mm
H 450 mm
L 1280 mm





Art. 116/D/1
□ 20 x 6 mm
H 450 mm
L 1280 mm



Art. 116/E/1
□ 20 x 8 mm
H 350 mm
L 1000 mm



Art. 696/1
□ 16 x 8 mm
H 280 mm
L 920 mm



Art. 116/E/2
□ 12 x 6 mm
H 240 mm
L 1030 mm



Art. 116/E/6
□ 30 x 8 mm
H 280 mm
L 810 mm





Art. 1281/3
 ☒ 16 x 8 mm
 H 340 mm - L 830 mm



Art. 1279/3
 ☒ 20 x 6 mm
 L 450 mm - H 190 mm



Art. 1279/4
 ☒ 20 x 6 mm
 H 235 mm - L 720 mm



Art. 116/D/3
 ⌀ 12 x 12 mm
 H 230 mm - L 820 mm



Art. 1280/1
 ☒ 20 x 6 mm
 H 300 mm - L 900 mm

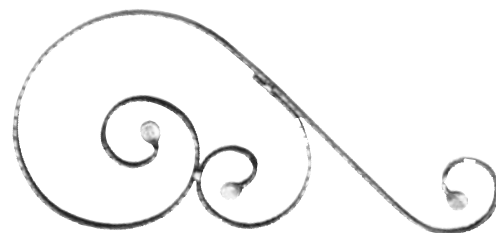

Art. 34/A/1
 ☒ 12 x 6 mm
 H 280 mm - L 580 mm

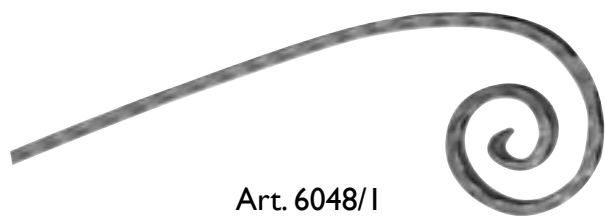

Art. 6048/1
 ☒ 30 x 20 mm
 H 200 mm - L 800 mm



Art. 6048/3
 ☒ 30 x 20 mm
 H 150 mm - L 800 mm



Art. 1281/4
 ☒ 16 x 8 mm
 H 260 mm - L 760 mm

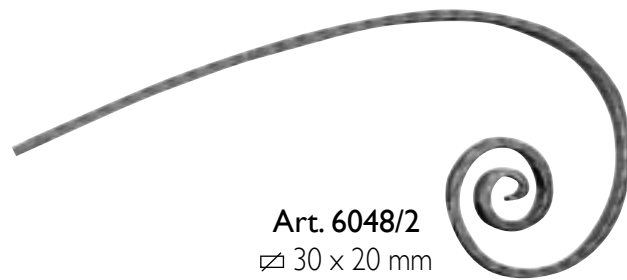

Art. 6048/2
 ☒ 30 x 20 mm
 H 300 mm - L 800 mm

Art. 116/D/4
 ☒ 30 x 8 mm
 H 1500 x L 460 mm

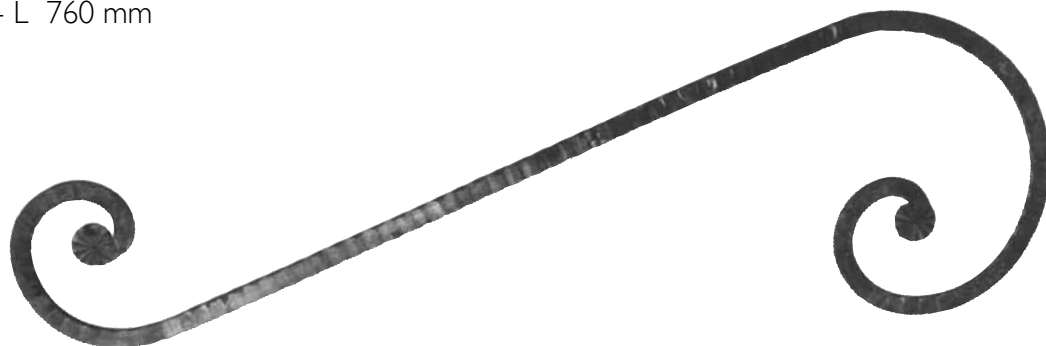



ARTEFERRO



Art. 116/E/4
 Ø 12 x 6 mm
 H 220 mm
 L 700 mm



Art. 116/E/3
 Ø 20 x 8 mm
 H 300 mm
 L 800 mm



Art. 1280/3
 Ø 12 x 6 mm
 H 195 mm
 L 490 mm



Art. 1280/2
 Ø 12 x 6 mm
 H 210 mm
 L 745 mm



Art. 1281/7
 Ø 20 x 8 mm
 H 250 mm
 L 750 mm



Art. 1281/8
 Ø 20 x 8 mm
 H 250 mm
 L 750 mm



Art. 1281/13
 □ 20 × 8 mm
 H 290 mm
 L 980 mm



Art. 1281/14
 □ 20 × 8 mm
 H 240 mm
 L 800 mm



Art. 1312/1
 ∅ 30 × 30 mm
 H 380 mm
 L 1400 mm

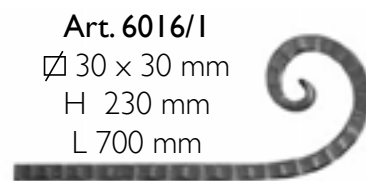

Art. 6016/1
 □ 30 × 30 mm
 H 230 mm
 L 700 mm



Art. 1281/9
 □ 20 × 8 mm
 H 310 mm
 L 850 mm



Art. 1281/10
 □ 20 × 8 mm
 H 310 mm
 L 850 mm



Art. 1281/5
 □ 20 × 8 mm
 H 430 mm
 L 1230 mm



Art. 1281/6
 □ 20 × 8 mm
 H 430 mm
 L 1230 mm



Art. 1281/11
 □ 20 × 8 mm
 H 310 mm
 L 1100 mm



Art. 1281/12
 □ 20 × 8 mm
 H 310 mm
 L 1100 mm



Art. NEW0077
 ∅ 35 x 8 mm
 H 400 mm
 L 1200 mm



Art. NEW0080
 ∅ 35 x 8 mm
 H 400 mm
 L 1300 mm



Art. NEW0079
 ∅ 35 x 8 mm
 H 250 mm
 L 700 mm



Art. NEW0078
 ∅ 35 x 8 mm
 H 570 mm
 L 2000 mm



Art. NEW0081
 ∅ 35 x 8 mm
 H 400 mm
 X 130 mm
 L 2100 mm



Art. NEW0082
 ∅ 35 x 8 mm
 H 400 mm
 X 130 mm
 L 2000 mm





BORCHIE E PIGNE BUSHES AND BASKETS

COMPENDIUM 2011

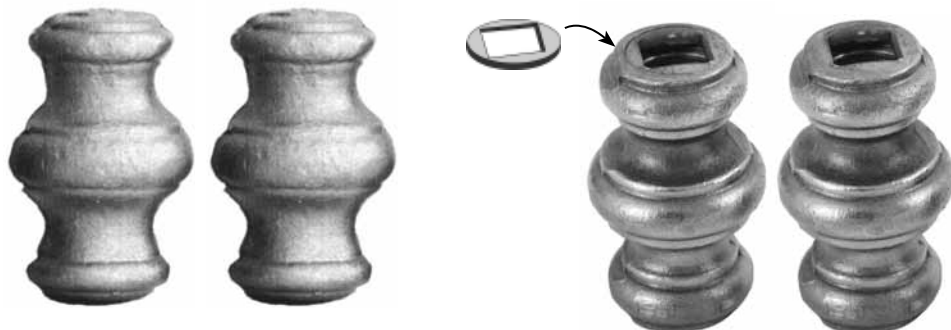
Art. 127/11
Art. 128/6
Art. 159/3





	foro hole 	FERRO STAMPATO STAMPED STEEL	FERRO FUSO CAST STEEL	foro hole 	FERRO STAMPATO STAMPED STEEL con inserto with insert	FERRO FUSO CAST STEEL senza inserto without insert
		Cod.art./Art.no.	Cod.art./Art.no.		Cod.art./Art.no.	Cod.art./Art.no.
H 65 mm Ø 40 mm	Senza Foro / Without hole	128/3				
	12 mm	128/6	747/18	12 x 12 mm	126/F/1	747/12
	14 mm	128/7	747/19	14 x 14 mm		
	16 mm	128/8	747/20	16 x 16 mm		
H 68 mm Ø 45 mm	Senza Foro / Without hole	128/4				
	12 mm			12 x 12 mm	126/F/2	1392/1
	14 mm			14 x 14 mm	126/F/3	747/13
	16 mm	128/9		16 x 16 mm		
	18 mm	128/10		18 x 18 mm		
	20 mm	128/11		20 x 20 mm		
H 78 mm Ø 50 mm	Senza Foro / Without hole	128/5				
	12 mm			12 x 12 mm		
	14 mm			14 x 14 mm	126/F/4	1392/2
	16 mm	128/12		16 x 16 mm	126/F/5	747/14
	18 mm	128/13		18 x 18 mm		
	20 mm	128/14		20 x 20 mm		
	22 mm	128/15		22 x 22 mm		

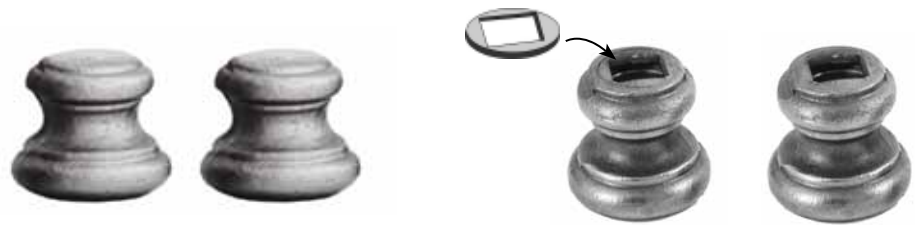

ARTEFERRO



	foro hole 	FERRO STAMPATO STAMPED STEEL	FERRO FUSO CAST STEEL	foro hole 	FERRO STAMPATO STAMPED STEEL con inserto with insert	FERRO FUSO CAST STEEL senza inserto without insert
		Cod.art./Art.no.	Cod.art./Art.no.		Cod.art./Art.no.	Cod.art./Art.no.
H 39 mm Ø 40 mm	Senza Foro / Without hole	128/16				
	12 mm	128/17	747/21	12 x 12 mm	126/F/6	747/15
	14 mm	128/18	747/22	14 x 14 mm		
	16 mm	128/19	747/23	16 x 16 mm		
H 44 mm Ø 45 mm	Senza Foro / Without hole	128/20				
	12 mm			12 x 12 mm	126/F/7	1392/3
	14 mm			14 x 14 mm	126/F/8	747/16
	16 mm	128/21		16 x 16 mm		
	18 mm	128/22		18 x 18 mm		
	20 mm	128/23		20 x 20 mm		
H 46 mm Ø 50 mm	Senza Foro / Without hole	128/24				
	12 mm			12 x 12 mm		
	14 mm			14 x 14 mm	126/F/9	1392/4
	16 mm	128/25		16 x 16 mm	126/F/10	747/17
	18 mm	128/26		18 x 18 mm		
	20 mm	128/27		20 x 20 mm		
	22 mm	128/28		22 x 22 mm		





	foro hole 	FERRO STAMPATO STAMPED STEEL con inserto with insert	FERRO FUSO CAST STEEL senza inserto without insert	FERRO FUSO CAST STEEL
		Cod.art./Art.no.	Cod.art./Art.no.	Cod.art./Art.no.
H 67 mm L 40 mm	Senza Foro / Without hole	127/5	1391/18	
	12 x 12 mm	127/7	1391/7	
	14 x 14 mm	127/8	1391/8	
	16 x 16 mm	127/9	1391/9	
H 65 mm L 40 mm	12 x 12 mm			1391/4
	14 x 14 mm			1391/5
	16 x 16 mm			1391/6
H 88 mm L 45 mm	Senza Foro / Without hole	127/3	1391/17	
	14 x 14 mm	127/10	1391/10	
	16 x 16 mm	127/11	1391/11	



ARTEFERRO



	foro hole 	FERRO STAMPATO STAMPED STEEL con inserto with insert	FERRO FUSO CAST STEEL senza inserto without insert	FERRO FUSO CAST STEEL
		Cod.art./Art.no.	Cod.art./Art.no.	Cod.art./Art.no.
H 38 mm L 40 mm	Senza Foro / Without hole	127/6	1391/20	
	12 x 12 mm	127/12	Art. 1391/12	
	14 x 14 mm	127/13	Art. 1391/13	
	16 x 16 mm	127/14	Art. 1391/14	
H 40 mm L 40 mm	12 x 12 mm			1391/1
	14 x 14 mm			1391/2
	16 x 16 mm			1391/3
H 45 mm L 45 mm	Senza Foro / Without hole	127/4	1391/19	
	14 x 14 mm	127/15	1391/15	
	16 x 16 mm	127/16	1391/16	



Ø 40 mm - H 23 mm

foro
hole



Sezione - Section	Cod.art./Art.no.
12 x 12 mm	128/38
14 x 14 mm	128/2
16 x 16 mm	128/39

foro
hole



Sezione - Section	Cod.art./Art.no.
Ø 12 mm	128/36
Ø 14 mm	128/1
Ø 16 mm	128/37



Ø 40 mm - H 24 mm

foro
hole



Sezione - Section	Cod.art./Art.no.
12 x 12 mm	1393/25
14 x 14 mm	1393/26

foro
hole



Sezione - Section	Cod.art./Art.no.
Ø 12 mm	1393/27
Ø 14 mm	1393/28

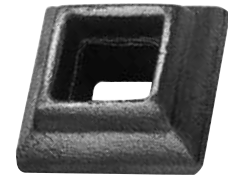

L 55 mm - H 25 mm

foro
hole



Sezione - Section	Cod.art./Art.no.
12 x 12 mm	1393/19
20 x 20 mm	1393/18



FERRO FUSO
CAST STEEL
senza inserto
without insert

H 45 mm - L 40 mm

Sezione - Section	Cod.art./Art.no.
12 x 12 mm	1391/21
14 x 14 mm	1391/22
16 x 16 mm	1391/23



ARTEFERRO



con inserto
with insert



Stampata a caldo
Hot stamped

Ø 45 mm - H 54 mm

foro
hole



Sezione - Section	Cod.art./Art.no.
Senza Foro Without hole	126/F/12
12 x 12 mm	126/F/13
14 x 14 mm	126/F/14

senza inserto
without insert



Ferro fuso
Cast steel

Ø 45 mm - H 54 mm

foro
hole



Sezione - Section	Cod.art./Art.no.
Senza Foro Without hole	1392/5
12 x 12 mm	1392/6
14 x 14 mm	1392/7



Stampata a caldo
Hot stamped

Ø 45 mm - H 54 mm

foro
hole





Sezione - Section	Cod.art./Art.no.
12 mm	739/1
14 mm	739/2
16 mm	739/3



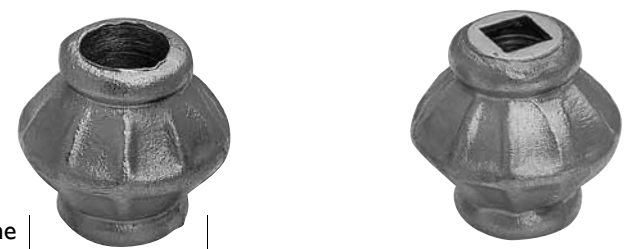

foro per sezione hole for 	H 120 mm Ø 32 mm	H 63 mm Ø 32 mm
	Cod.art./Art.no.	Cod.art./Art.no.
Senza Foro / Without hole		Art. 128/C/15
Ø 12 mm	Art. 128/C/9	Art. 128/C/12
Ø 14 mm	Art. 128/C/10	Art. 128/C/13
Ø 16 mm	Art. 128/C/11	Art. 128/C/14



foro per sezione hole for 	H 65 mm Ø 60 mm	foro per sezione hole for 	FERRO FUSO CAST STEEL H 65 mm Ø 60 mm
	Cod.art./Art.no.		Cod.art./Art.no.
Senza Foro / Without hole		14 x 14 mm	Art. 1393/23
Ø 16 mm	Art. 1393/20	16 x 16 mm	Art. 1393/24
Ø 20 mm	Art. 1393/21		
Ø 24 mm	Art. 1393/22		



foro per sezione hole for 	H 78 mm Ø 69 mm	H 50 mm Ø 69 mm
	Cod.art./Art.no.	Cod.art./Art.no.
Senza Foro / Without hole	Art. 128/C/3	Art. 741/6
Ø 20 mm	Art. 128/C/4	Art. 741/1
Ø 25 mm	Art. 128/C/5	Art. 741/2
Ø 30 mm	Art. 128/C/6	Art. 741/3
Ø 35 mm	Art. 128/C/7	Art. 741/4
Ø 40 mm	Art. 128/C/8	Art. 741/5
foro per sezione hole for 		
	Cod.art./Art.no.	
25 x 25 mm	Art. 741/7	
30 x 30 mm	Art. 741/8	



Art. 697/5
Ø 16 mm
foro /hole Ø 8 mm



Art. 697/7
Ø 12 mm
foro /hole Ø 6 mm

Art. 697/8
Ø 12 mm
foro /hole Ø 5 mm



Art. 1854/1
Ø 35 mm
H 40 mm
foro per sezione
hole for Ø 12 mm

Art. 1854/2
Ø 35 mm
H 40 mm
foro per sezione
hole for Ø 14 mm



Art. 1854/3
Ø 35 mm
H 40 mm
foro per sezione
hole for □ 12 mm



**GHISA MALLEABILE SALDABILE, MA NON ZINCABILE
MALLEABLE WELDABLE CAST IRON, GALVANIZING IS NOT RECOMMENDED**



Art. 746/6

H 40 mm
L 38 mm

foro per sezione/hole for
 \varnothing 14 x 14 mm



Art. 746/5

H 65 mm
L 40 mm

foro per sezione/hole for
 \varnothing 14 x 14 mm

Art. 1390/5

H 65 mm
L 40 mm

foro per sezione/hole for
 \varnothing 16 x 16 mm



Art. 1390/1

H 17 mm
L 38 mm

foro per sezione/hole for
 \varnothing 17 x 17 mm



Art. 746/1

H 45 mm
L 40 mm

foro per sezione/hole for
 \varnothing 12 x 12 mm



Art. 746/2

H 50 mm
L 55 mm

foro per sezione/hole for
 \varnothing 20 x 20 mm



Art. 746/3

H 48 mm
L 48 mm

foro per sezione/hole for
 \varnothing 16 x 16 mm



Art. 1390/4

H 40 mm
L 60 x 40 mm

foro per sezione/hole for
 \square 28 x 8 mm



Art. 1390/3

H 48 mm
L 50 mm

foro per sezione/hole for
 \varnothing 16 x 16 mm



Art. 1390/2

H 45 mm
L 48 mm

foro per sezione/hole for
 \varnothing 16 x 16 mm



Art. 746/4

H 30 mm
L 48 mm

foro per sezione/hole for
 \varnothing 16 x 16 mm



Art. 747/3

H 20 mm
L 35 mm

foro per sezione/hole for
 \varnothing 16 x 16 mm

**GHISA MALLEABILE SALDABILE, MA NON ZINCABILE
MALLEABLE WELDABLE CAST IRON, GALVANIZING IS NOT RECOMMENDED**



Art. 747/5
H 185 mm
Ø 40 mm
foro per sezione/hole for
Φ 16 x 16 mm



Art. 747/6
H 130 mm
Ø 40 mm
foro per sezione/hole for
Φ 16 x 16 mm



Art. 747/7
H 75 mm
Ø 40 mm
foro per sezione/hole for
Φ 16 x 16 mm



Art. 747/1
H 260 mm
Ø 50 mm
foro per sezione/hole for
Φ 16 x 16 mm



Art. 747/4
H 20 mm
Ø 33 mm
foro per sezione/hole for
Ø 16 mm



Art. 747/10
H 70 mm
Ø 40 mm
foro per sezione/hole for
Φ 14 x 14 mm



Art. 1491/3
H 28 mm
L 40 mm
foro per sezione/hole for
Φ 12 x 12 mm



H 115 mm
Ø 40 mm
Art. 747/8
foro per sezione/hole for
Φ 14 x 14 mm

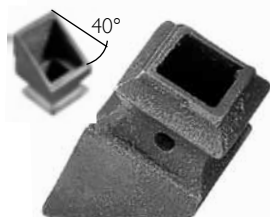

Art. 1491/1
H 50 mm
L 30 mm

Art. 1491/2
H 50 mm
L 30 mm

Art. 747/9
foro per sezione/hole for
Φ 12 x 12 mm

foro per sezione/hole for
Φ 12 x 12 mm

foro per sezione/hole for
Φ 14 x 14 mm

Art. 1491/4
H 28 mm
L 40 mm
foro per sezione/hole for
Φ 14 x 14 mm

Art. 1491/5
H 45 mm
L 70 mm
foro per sezione/hole for
Φ 27 x 27 mm



Art. 747/2
H 110 mm
L 35 mm
foro per sezione/hole for
Φ 16 x 16 mm

BORCHIE TORNITE CON FORI CIECHI Ø 12,3 mm (Profondità/width 10 mm)
LATHED BUSHES WITH BLIND HOLES Ø 12,3 mm (width 10 mm)



Art. GD265/1
 H 87 mm
 Ø 25 mm

Art. GD265/4
 H 88 mm
 Ø 33 mm

Art. GD265/5
 H 108 mm
 Ø 27 mm

Art. GD265/2
 H 112 mm
 Ø 25 mm

Art. GD265/3
 H 120 mm
 Ø 30 mm



BORCHIE e PIGNE - BUSHES and BASKETS

ARTEFERRO



Art. 1389/1
33 x 200 mm
Ø 12 x 12 mm



Art. 1389/2
53 x 200 mm
Ø 12 x 12 mm



Art. 1389/3
53 x 200 mm
Ø 12 mm



Art. 1389/4
30 x 150 mm
Ø 12 x 12 mm



Art. 1389/5
30 x 150 mm
Ø 12 x 12 mm



Art. 1389/6
30 x 150 mm
Ø 12 mm



Art. 738/1
37 x 150 mm
Ø 12 mm



Art. 738/2
35 x 120 mm
Ø 12 mm



Art. 738/3
45 x 120 mm
Ø 12 mm



Art. 738/4
35 x 120 mm
Ø 12 mm



Art. 738/5
50 x 170 mm
Ø 14 x 14 mm



Art. 738/6
50 x 170 mm
Ø 14 x 14 mm



Art. 738/7
40 x 170 mm
Ø 12 mm



Art. 738/8
42 x 120 mm
Ø 12 mm



Art. 738/9
40 x 120 mm
Ø 12 mm

BORCHIE
MAGLIATE

FORGED BUSHES

Ø = diameter



Art. 738/10
70 x 150 mm
Ø 30 mm



Art. 738/11
70 x 150 mm
Ø 30 mm



Art. 154/1

H 120 mm
Ø 30 mm

foro per sezione
hole for Ø 12 mm

Art. 154/A/3

H 180 mm
Ø 40 mm

foro per sezione
hole for Ø 16 mm



Art. 154/A/4

H 85 mm
Ø 30 mm

foro per sezione
hole for

Ø 12 mm



Art. 154/3

H 105 mm
Ø 30 mm

foro per sezione
hole for Ø 12 mm



Art. 154/4

H 140 mm
Ø 30 mm

foro per sezione
hole for

Ø 12 mm



Art. 154/5

H 100 mm
Ø 30 mm

foro per sezione
hole for

Ø 12 mm



Art. 155/7

H 30 mm
Ø 30 mm

foro per sezione
hole for

Ø 12 mm

Art. 154/A/8

H 45 mm
Ø 40 mm

foro per sezione
hole for

Ø 16 mm



Art. 154/B/3

H 120 mm
Ø 40 mm

foro per sezione
hole for Ø 14 mm

Art. 154/B/4

H 120 mm
Ø 40 mm

foro per sezione
hole for

Ø 16 mm



Art. 154/B/5

H 95 mm
Ø 40 mm

foro per sezione
hole for

Ø 14 mm

Art. 154/B/6

H 95 mm
Ø 40 mm

foro per sezione
hole for

Ø 16 mm



Art. 155/4

H 20 mm
Ø 30 mm

foro per sezione
hole for

Ø 12 mm

Art. 154/A/7

H 25 mm
Ø 40 mm

foro per sezione
hole for

Ø 16 mm



Art. 1793/7

H 83 mm
Ø 50 mm

foro per sezione
hole for

Ø 22 mm



Art. 1793/8

H 65 mm
Ø 50 mm

foro per sezione
hole for

Ø 22 mm



Art. 154/A/1

H 105 mm
Ø 40 mm
foro / hole
Ø 14 mm

Art. 154/A/5

H 105 mm
Ø 40 mm
foro / hole
Ø 16 mm

Art. 154/B/1

H 105 mm
Ø 40 mm
foro / hole
Ø 12 mm

Art. 155/2

H 65 mm
Ø 30 mm
foro / hole
Ø 12 mm



Art. 154/2

H 150 mm
Ø 30 mm
foro per sezione
hole for
Ø 12 mm



Art. 155/6

H 65 mm
Ø 30 mm
hole for
Ø 13 mm



Art. 155/1

H 85 mm
Ø 30 mm
foro per sezione
hole for
Ø 12 mm



Art. 154/A/2

H 75 mm
Ø 40 mm
foro per sezione
hole for
Ø 14 mm

Art. 154/A/6

H 75 mm
Ø 40 mm
foro per sezione
hole for
Ø 16 mm

Art. 154/B/2

H 75 mm
Ø 40 mm
foro per sezione
hole for
Ø 12 mm



Art. 155/5

H 85 mm
Ø 30 mm
foro per sezione
hole for
Ø 12 mm

Art. 155/3

H 50 mm
Ø 30 mm
foro per sezione
hole for
Ø 12 mm



ARTEFERRO



Art. 1243/1
H 180 mm
Ø 30 mm
foro/hole
Ø 12 mm



Art. 1243/2
H 140 mm
Ø 30 mm
foro/hole
Ø 12 mm



Art. 1243/3
H 60 mm
Ø 30 mm
foro/hole
Ø 12 mm



Art. 1243/4
H 150 mm
Ø 30 mm
foro/hole
Ø 12 mm



H 63 mm
Ø 35 mm

Art. 126/F/11
senza foro
Without hole

Art. 739/4
foro/hole Ø 12 mm

Art. 739/5
foro/hole Ø 14 mm

Art. 739/6
foro/hole Ø 16 mm



Art. 726/10
H 100 mm
base Ø 12 mm

Art. 726/11
H 125 mm
base Ø 15 mm



ARTEFERRO

Ø = diameter



Art. 1243/8
H 70 mm
Ø 30 mm
foro/hole
Ø 12 mm



Art. 1243/7
H 100 mm
Ø 30 mm
foro/hole
Ø 12 mm



Art. 1243/6
H 185 mm
Ø 30 mm
foro/hole
Ø 12 mm



Art. 1243/5
H 330 mm
Ø 30 mm
foro/hole
Ø 12 mm



Art. 1243/9
H 155 mm
Ø 30 mm
foro/hole
Ø 12 mm



Art. 1243/10
H 145 mm
Ø 30 mm
foro/hole
Ø 12 mm



Art. 1243/11
H 155 mm
Ø 30 mm
foro/hole
Ø 12 mm



Art. 1243/12
H 90 mm
Ø 30 mm
foro/hole
Ø 12 mm

Borchie Forgiate
Hand Forged Bushes



H 40 mm
Ø 45 mm
Art. 737/1
foro/hole
Ø 16 mm

Art. 737/2
foro/hole
Ø 18 mm

Art. 737/3
foro/hole
Ø 20 mm



H 68 mm
Ø 45 mm
Art. 737/4
foro/hole
Ø 16 mm

Art. 737/5
foro/hole
Ø 18 mm

Art. 737/6
foro/hole
Ø 20 mm



Art. 737/7
H 40 mm
L 42 mm



Art. 737/8
H 85 mm
L 42 mm

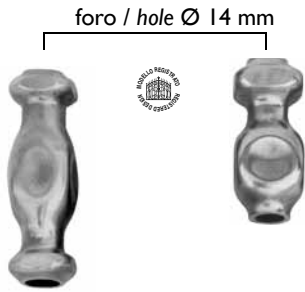

Art. 742/1
H 105 mm
34 x 34 mm
sp/thick 2 mm

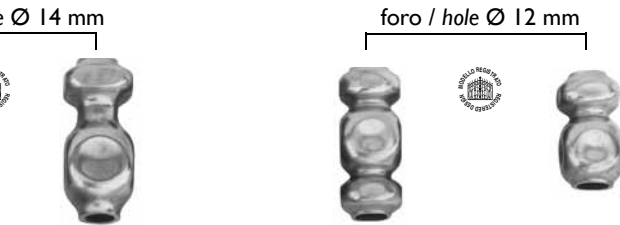

Art. 742/2
H 75 mm
34 x 34 mm
sp/thick 2 mm

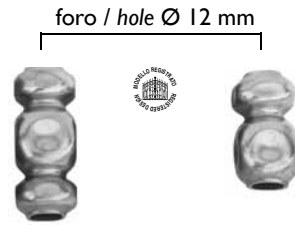

Art. 742/3
H 65 mm
25 x 25 mm
sp/thick 2 mm

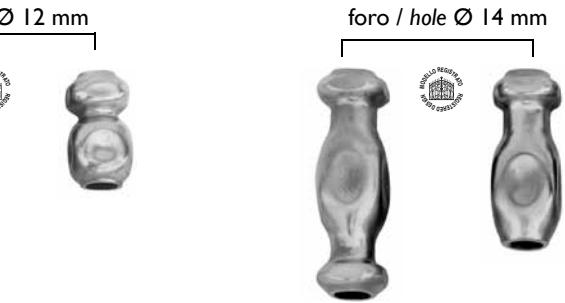

Art. 742/4
H 50 mm
25 x 25 mm
sp/thick 2 mm

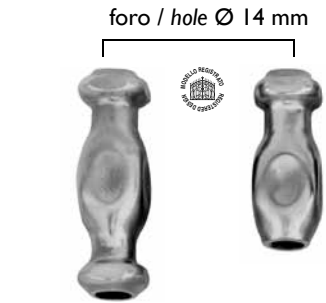

Art. 742/5
H 120 mm
34 x 34 mm
sp/thick 2 mm



Art. 742/6
H 90 mm
34 x 34 mm
sp/thick 2 mm

BORCHIE IN TUBO RIGATO
FORO Ø 13 mm

GROOVED STEEL TUBE BUSHING
HOLE Ø 13 mm

Ø = diameter



Art. 1244/4
H 150 mm
Ø 30 mm



Art. 1244/1
H 180 mm
Ø 30 mm



Art. 1244/2
H 140 mm
Ø 30 mm



Art. 1244/3
H 60 mm
Ø 30 mm



Art. 1244/8
H 70 mm
Ø 30 mm



Art. 1244/7
H 100 mm
Ø 30 mm



Art. 1244/6
H 185 mm
Ø 30 mm



Art. 1244/5
H 330 mm
Ø 30 mm



Art. 1244/9
H 140 mm
Ø 30 mm



Art. 1244/10
H 85 mm
Ø 30 mm



Art. 1244/11
H 100 mm
Ø 30 mm



Art. 1244/12
H 120 mm
Ø 30 mm



Art. 1244/13
H 85 mm
Ø 30 mm



Art. 1244/14
H 65 mm
Ø 30 mm



Art. 1244/15
H 30 mm
Ø 30 mm



Art. 1244/16
H 155 mm
Ø 30 mm



Art. 1244/17
H 145 mm
Ø 30 mm



Art. 1244/18
H 155 mm
Ø 30 mm



Art. 1244/19
H 90 mm
Ø 30 mm



Art. 1244/20
H 150 mm
Ø 30 mm



Art. 1244/21
H 105 mm
Ø 30 mm



Art. 1244/22
H 65 mm
Ø 30 mm



Art. 1244/23
H 50 mm
Ø 30 mm

Ø = diameter



	Cod.art./Art.no.	Cod.art./Art.no.	Cod.art./Art.no.	Cod.art./Art.no.
H 55 mm Ø 35 mm	1393/14 foro per sezione hole for Ø 12 mm	1393/15 foro per sezione hole for Ø 14 mm	1393/16 foro per sezione hole for Ø12 x 12 mm	1393/17 foro per sezione hole for Ø14 x 14 mm
H 75 mm Ø 50 mm	1393/10 foro per sezione hole for Ø 18 mm	1393/11 foro per sezione hole for Ø 20 mm	1393/12 foro per sezione hole for Ø14 x 14 mm	1393/13 foro per sezione hole for Ø16 x 16 mm

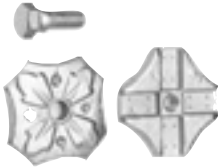

Ø 65 mm
Art. 698/1
Art. 001/N
zincato/galvanized



Art. 852/3
H 13 mm
Ø 19 mm
foro/hole Ø 8 mm

H 95 mm - Ø 50 mm
Art. 128/B/1
senza foro/without hole
Art. 128/B/2
foro/hole Ø 20 mm



Ø = diameter

**VETRO
GLASS**

Ø 84 mm



Art. 478/3
Blu - Blue



Art. 478/4
Verde - Green



Art. 478/5
Giallo - Yellow



Art. 478/6
Rosso - Red

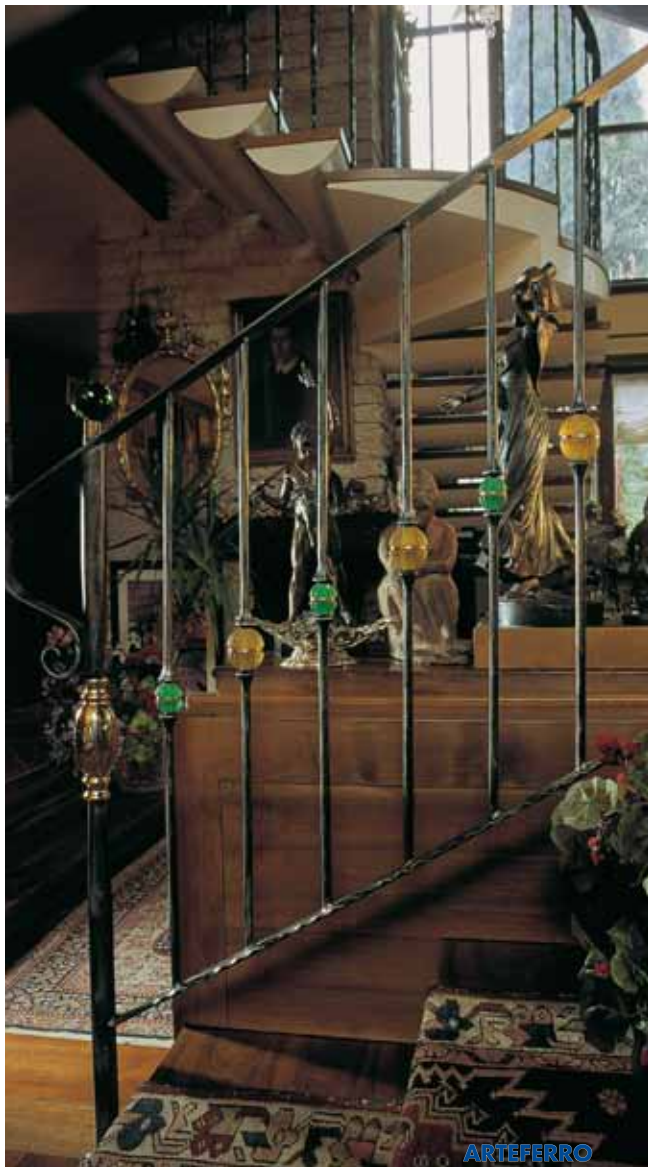

Art. 745/2
Ø 46 mm
foro / hole
Ø 12 mm



Art. 745/3
Ø 52 mm
foro/hole
Ø 12 mm



Art. 745/4
Ø 57 mm
foro/hole
Ø 16 mm



Art. 745/5
Ø 57 mm
foro/hole
Ø 16 mm

**BORCHIE in
LEGNO
WOOD
BUSHES**



Art. 745/1
Ø 97 mm



Art. 745/7
H 130 mm
Ø 64 mm
foro/hole
Ø 20 mm



Art. 745/8
H 165 mm
Ø 70 mm
foro/hole
Ø 20 mm



Art. 745/9
H 165 mm
Ø 70 mm
foro/hole
Ø 20 mm



Art. 745/6
H 74 mm
Ø 97 mm
foro/hole
Ø 20 mm



Art. 745/10
H 205 mm
Ø 63 mm
foro/hole
Ø 20 mm



Art. 745/11
H 205 mm
Ø 63 mm
foro/hole
Ø 20 mm



Cod.art./Art.no.	Ø	H	A	B
159/1	35 mm	90 mm	8 × 8 mm	4 × 4 mm
159/2	55 mm	110 mm	10 × 10 mm	5 × 5 mm
159/3	60 mm	125 mm	12 × 12 mm	6 × 6 mm
159/4	60 mm	125 mm	14 × 14 mm	7 × 7 mm
159/5	65 mm	145 mm	16 × 16 mm	8 × 8 mm
159/6	80 mm	165 mm	20 × 20 mm	10 × 10 mm
159/7	95 mm	180 mm	24 × 24 mm	12 × 12 mm
159/9	100 mm	220 mm	30 × 30 mm	15 × 15 mm
159/10	130 mm	280 mm	40 × 40 mm	20 × 20 mm



Cod.art./Art.no.	Ø	H	A	B
158/B/1	55 mm	130 mm	12 × 12 mm	4 × 4 mm
158/B/2	60 mm	145 mm	15 × 15 mm	5 × 5 mm
158/B/3	80 mm	170 mm	21 × 21 mm	7 × 7 mm
158/B/4	95 mm	220 mm	24 × 24 mm	8 × 8 mm
158/B/5	95 mm	270 mm	30 × 30 mm	10 × 10 mm

Ø = diameter

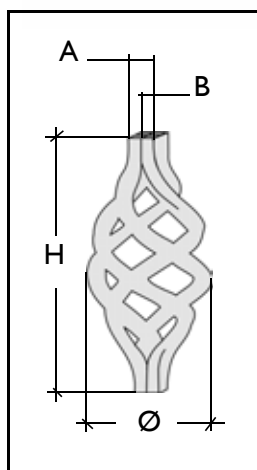

Cod.Art./ Art. no.	Ø	H	A	B
1163/1	35 mm	90 mm	8 × 8 mm	Ø 4 mm
1163/2	55 mm	110 mm	10 × 10 mm	Ø 5 mm
1163/3	55 mm	125 mm	12 × 12 mm	Ø 6 mm
1163/4	60 mm	125 mm	14 × 14 mm	Ø 7 mm
1163/5	70 mm	145 mm	16 × 16 mm	Ø 8 mm
1163/6	75 mm	165 mm	20 × 20 mm	Ø 10 mm
1163/7	100 mm	180 mm	24 × 24 mm	Ø 12 mm
1163/8	110 mm	220 mm	30 × 30 mm	Ø 15 mm



Art. 1163/10
Ø 70 mm
B = 8 x 8 mm

Art. 1163/11
Ø 115 mm
B = 12 x 12 mm

Ø = diameter



Art. 158/B/7
Ø 70 mm
B = 8 x 8 mm



Art. 158/B/6
Ø 70 mm
B = 8 x 8 mm



Art. 1163/12
Ø 90 mm
B = 6 x 6 mm



Art. 158/B/8
Ø 40 mm
H 125 mm
A = 12 x 12 mm
B = 6 x 6 mm



Art. 1163/9
Ø 70 mm
B = Ø 6 mm

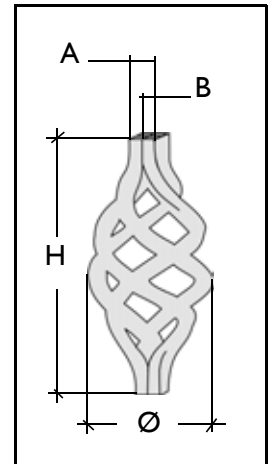

Art. 1164/3
Ø 80 mm
H 180 mm
A = Ø 20 mm
B = 10 x 10 mm
Foro/Hole Ø 10 mm



Art. 1164/2
Ø 70 mm
B = 6 x 6 mm
Foro/Hole Ø 6 mm

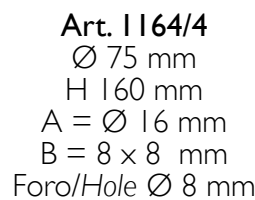

Art. 1164/4
Ø 75 mm
H 160 mm
A = Ø 16 mm
B = 8 x 8 mm
Foro/Hole Ø 8 mm



Art. 1164/1
Ø 90 mm
B = 6 x 6 mm
Foro/Hole Ø 6 mm





ARTEFERRO



TERMINALI DI COLONNA COLUMN TERMINALS COMPENDIUM 2011

Art. 749/17
Art. 1854/5
Art. 1854/4



Art. 749/7
 Ø 28 mm
 H 55 mm

Art. 749/8
 Ø 43 mm
 H 85 mm

Art. 749/9
 Ø 55 mm
 H 120 mm

Art. 749/10
 Ø 70 mm
 H 150 mm

Art. 749/11
 Ø 90 mm
 H 190 mm



Art. 749/12
 Ø 30 mm
 H 60 mm

Art. 749/13
 Ø 45 mm
 H 85 mm

Art. 749/14
 Ø 47 mm
 H 125 mm

Art. 749/15
 Ø 60 mm
 H 150 mm

Art. 749/16
 Ø 90 mm
 H 200 mm



Art. 749/17
 Φ 25 x 25 mm
 H 60 mm

Art. 749/18
 Φ 40 x 40 mm
 H 85 mm

Art. 749/19
 Φ 60 x 60 mm
 H 125 mm

Art. 749/20
 Φ 80 x 80 mm
 H 150 mm

Art. 749/21
 Φ 100 x 100 mm
 H 200 mm



Art. 128/31
 Ø 100 mm
 H 180 mm

Art. 128/35
 Ø 50 mm
 H 90 mm



Art. 749/4
 Ø 27 mm
 H 65 mm

Art. 749/5
 Ø 40 mm
 H 85 mm

Art. 749/6
 Ø 55 mm
 H 120 mm



ARTEFERRO

CAPPELLOTTI E COPERCHI IN LAMIERA D'ACCIAIO PER TUBI
PRESSED STEEL POST CAPS

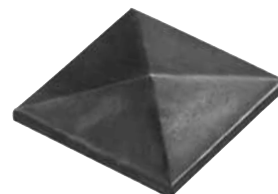

LAMIERA d'ACCIAIO PUNTATA
 SHEET METAL CAP SPOT WELDED

Sezione Section	Cod.art. Art.no.	Altezza Height
Φ 30 x 30 mm	● 167/15	
Φ 40 x 40 mm	● 167/16	
Φ 50 x 50 mm	1858/1	70 mm
Φ 60 x 60 mm	1858/2	84 mm
Φ 70 x 70 mm	1858/3	98 mm
Φ 80 x 80 mm	1858/4	115 mm
Φ 100 x 100 mm	1858/5	136 mm
Φ 120 x 120 mm	1858/6	164 mm
Φ 150 x 150 mm	1858/7	192 mm

Cod.art. Art.no.	Altezza Height
-	
-	
-	
-	
-	
167/11	115 mm
167/12	136 mm
167/13	164 mm
167/14	192 mm

Cod.art. Art.no.
167/3
167/4
167/5
167/6
-
167/7
167/8
167/9
167/10

● Forgiati a caldo
 Hot stamped solid steel



Sfera vuota - Hollow sphere

Art. 1165/6

Φ 35 x 35 mm
 Ø 40 mm

Art. 1165/5

Φ 45 x 45 mm
 Ø 50 mm

Art. 1165/4

Φ 55 x 55 mm
 Ø 60 mm

Art. 1165/3

Φ 65 x 65 mm
 Ø 70 mm

Art. 1165/2

Φ 85 x 85 mm
 Ø 90 mm

Art. 1165/1

Φ 105 x 105 mm
 Ø 100 mm



H 300 mm



Sezione Section	Cod.art. Art.no.	Cod.art. Art.no.	Cod.art. Art.no.	Cod.art. Art.no.
Φ 14 x 14 mm	178/19	178/21	178/23	178/25
Φ 30 x 30 mm	178/20	178/22	178/24	178/26
Φ 40 x 40 mm	178/29	178/30	178/31	178/32
∇ 30 x 20 mm	-	-	178/28	178/27
∇ 40 x 20 mm	-	-	178/34	178/33

TERMINALI DI COLONNA - COLUMN TERMINALS



Forgiato
a mano
*Hand
forged*

H 300 mm
Art. 178/35
Φ 40 mm
Art. 178/36
Φ 30 mm
Art. 178/37
Φ 35 mm



H 300 mm
Art. 593/7
40 x 6 mm



H 300 mm
Art. 593/6
40 x 8 mm



H 300 mm
Art. 593/1
30 x 20 mm
Art. 593/2
Φ 25 mm
Art. 593/3
Φ 30 mm



H 300 mm
Art. 593/5
40 x 8 mm



H 300 mm
Art. 593/4
40 x 6 mm



H 300 mm
Art. 593/10
50 x 6 mm
Art. 593/11
60 x 6 mm



Art. 158/B/9
Φ 105 mm
H 200 mm



Art. 158/B/10
85 x 85 mm
H 200 mm



Art. 749/3
Ø 50 mm
H 190 mm



Art. 128/29
Ø 50 mm
H 105 mm



Art. 128/33
Ø 28 mm
H 80 mm



Art. 128/C/1
Ø 160 mm
H 360 mm



Art. 128/C/2
Ø 160 mm
H 405 mm

Art. 158/B/11
12 x 12 mm
H 185 mm

Art. 128/32
Ø 100 mm
H 200 mm

Art. 128/30
Ø 50 mm
H 100 mm

Art. 128/34
Ø 100 mm
H 200 mm

GHISA - CAST IRON



Art. 1854/4
Ø 32 mm
H 400 mm



Art. 1854/5
Ø 32 mm
H 570 mm



Art. 1854/6
Ø 40 mm
H 680 mm



ARTEFERRO



SFERE - SPHERES

COMPENDIUM 2011

Art. 116/F/1
Art. 116/F/2
Art. 116/F/3
Art. 116/F/4



Diametro Diameter	SFERE LISCE STAMPATE a caldo HOT STAMPED SPHERES	SFERE FORGIATE a mano HAND FORGED SPHERES	SFERE VUOTE HOLLOW SPHERES
	Cod.art./Art.no.	Cod.art./Art.no.	Cod.art./Art.no.
Ø 16 mm	-	117/1	-
Ø 20 mm	116/F/1	117/2	1394/1 Foro/Hole Ø 6 mm Spessore/Thickness 2 mm
Ø 22 mm	-	-	1394/2 Foro/Hole Ø 6 mm Spessore/Thickness 2 mm
Ø 25 mm	116/F/2	117/3	1394/3 Foro/Hole Ø 6 mm Spessore/Thickness 2 mm
Ø 30 mm	116/F/3	117/4	1394/4 Foro/Hole Ø 6 mm Spessore/Thickness 2 mm
Ø 35 mm	123/1	117/5	1394/5 Foro/Hole Ø 7 mm Spessore/Thickness 2 mm
Ø 40 mm	116/F/4	117/6	1394/6 Foro/Hole Ø 7 mm Spessore/Thickness 2 mm
Ø 45 mm	-	-	1394/7 Foro/Hole Ø 8 mm Spessore/Thickness 2 mm
Ø 50 mm	116/F/5	117/7	1394/8 Foro/Hole Ø 9 mm Spessore/Thickness 2 mm
Ø 55 mm	-	-	1394/9 Foro/Hole Ø 9 mm Spessore/Thickness 2 mm
Ø 60 mm	116/F/6	117/8	1394/10 Foro/Hole Ø 10 mm Spessore/Thickness 2 mm
Ø 70 mm	116/F/7	117/9	1394/11 Foro/Hole Ø 10 mm Spessore/Thickness 2 mm
Ø 80 mm	116/F/8	113/12	1394/12 Foro/Hole Ø 11 mm Spessore/Thickness 2 mm
Ø 90 mm	116/F/9	-	1394/13 Spessore/Thickness 2 mm
Ø 100 mm	116/F/10	113/11	1394/14 Spessore/Thickness 2 mm
Ø 110 mm	-	-	1394/15 Spessore/Thickness 2,5 mm
Ø 120 mm	116/F/17	117/15	1394/16 Spessore/Thickness 2 mm
Ø 130 mm	-	-	1394/17 Spessore/Thickness 2 mm
Ø 140 mm	-	-	1394/18 Spessore/Thickness 2 mm
Ø 150 mm	116/F/19	117/16	1394/19 Spessore/Thickness 2 mm
Ø 200 mm	-	-	1394/20 Spessore/Thickness 1,5 mm



Diametro Diameter	SFERE VUOTE SALDATE HOLLOW SPHERES WELDED Foro/Hole 12,5 mm Spessore/Thickness 2 mm	SFERE MEZZE VUOTE HOLLOW HALF SPHERES Foro/Hole 12,5 mm Spessore/Thickness 2 mm	MEZZE SFERE HALF SPHERES
	Cod.art./Art.no.	Cod.art./Art.no.	Cod.art./Art.no.
Ø 25 mm	1394/25	1395/10 H = 12 mm	-
Ø 30 mm	1394/24	1395/9 H = 15 mm	3002/13 H = 15 mm
Ø 35 mm	-	-	819/14 H = 17,5 mm
Ø 40 mm	1394/23	1395/8 H = 20 mm	819/13 H = 20 mm
Ø 50 mm	1394/22	1395/7 H = 25 mm	819/12 H = 25 mm
Ø 55 mm	-	1395/6 H = 27 mm	-
Ø 60 mm	1394/21	-	-



SFERE VUOTE NON SALDATE
HOLLOW SPHERES NOT WELDED

Spessore/Thickness 3 mm

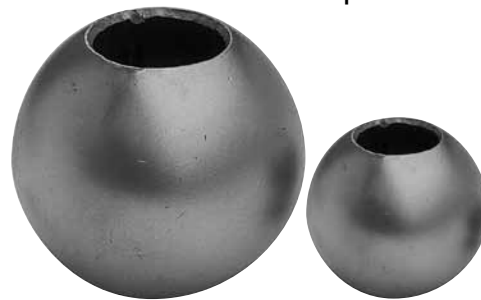

Art. 1395/5

Ø 25 mm

H 22 mm

Foro/Hole Ø 6 mm

Art. 1395/2

Ø 50 mm

H 45 mm

Foro/Hole Ø 16 mm

Art. 1395/4

Ø 30 mm

H 28 mm

Foro/Hole Ø 6 mm

Art. 1395/1

Ø 80 mm

H 70 mm

Foro/Hole Ø 35 mm

Art. 1395/3

Ø 40 mm

H 35 mm

Foro/Hole Ø 12,5 mm

ARTEFERRO



SFERE DIAMANTATE
HOT FORGED
FACETED SPHERES

Art. 116/F/11

Ø 20 mm

Art. 116/F/12

Ø 25 mm

Art. 116/F/13

Ø 30 mm

Art. 116/F/14

Ø 35 mm

Art. 116/F/15

Ø 40 mm

Art. 116/F/16

Ø 50 mm

Art. 116/F/18

Ø 60 mm



SFERE FORGIATE OVALI
OVAL FORGED SPHERES

Art. 1396/3

Ø 40 mm

H 60 mm

Art. 1396/5

Ø 28 mm

H 38 mm

Art. 1396/4

Ø 30 mm

H 50 mm

Art. 1396/2

Ø 55 mm

H 75 mm

Art. 1396/1

Ø 65 mm

H 95 mm



SFERE FORGIATE
SCHIACCIATE
FORGED PRESSED
SPHERES

Art. 202/7

Ø 40 mm

H 25 mm

Art. 202/6

Ø 45 mm

H 28 mm

Art. 202/5

Ø 60 mm

H 35 mm

Art. 202/4

Ø 70 mm

H 40 mm

Art. 202/3

Ø 80 mm

H 51 mm

Art. 202/2

Ø 90 mm

H 57 mm

Art. 202/1

Ø 110 mm

H 67 mm

SFERA in VETRO / GLASS SPHERES
Foro/Hole 18 mm



Ø 50 mm

Art. 531/2 - Blu/Blue

Art. 531/3 - Verde/Green

Art. 531/4 - Giallo/Yellow

Art. 531/5 - Rosso/Red



Art. 1218/3

Cristallo lucido / Glass

Ø 50 mm - Foro/Hole Ø 11 mm



Art. 1218/4

Cristallo lucido rosso / Red glass

Ø 42 mm

Bussola con foro fil. Ø 6 mm

Brass with threaded hole Ø 6 mm



Art. 1218/5

Cristallo lucido verde / Green glass

Ø 35 mm - H 25 mm - Foro/Hole Ø 11 mm



Art. 1214/1

Rosa satinato

Satin pink

Ø 40 mm

H 20 mm

Foro/Hole

Ø 11 mm



Art. 1214/2

Verde satinato

Satin green



Art. 1214/3

Giallo satinato

Satin yellow

Ø 55 mm

H 28 mm

Foro/Hole

Ø 11 mm



Art. 1214/4

Blu satinato

Blue satin

Ø 55 mm - Foro/Hole 19,5 mm

Sfera in ceramica dipinta a mano
Hand painted ceramic spheres

Granito rosso
michelangelo

Michelangelo
red granite

Marmo
di carrara bianco

White carrara
marble

Marmo nero totale
Total black marble



Art. 533/5



Art. 533/6

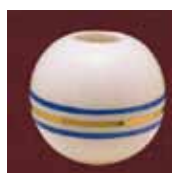

Art. 533/7



Art. 533/8



Art. 535/4



Art. 535/5



Art. 535/6

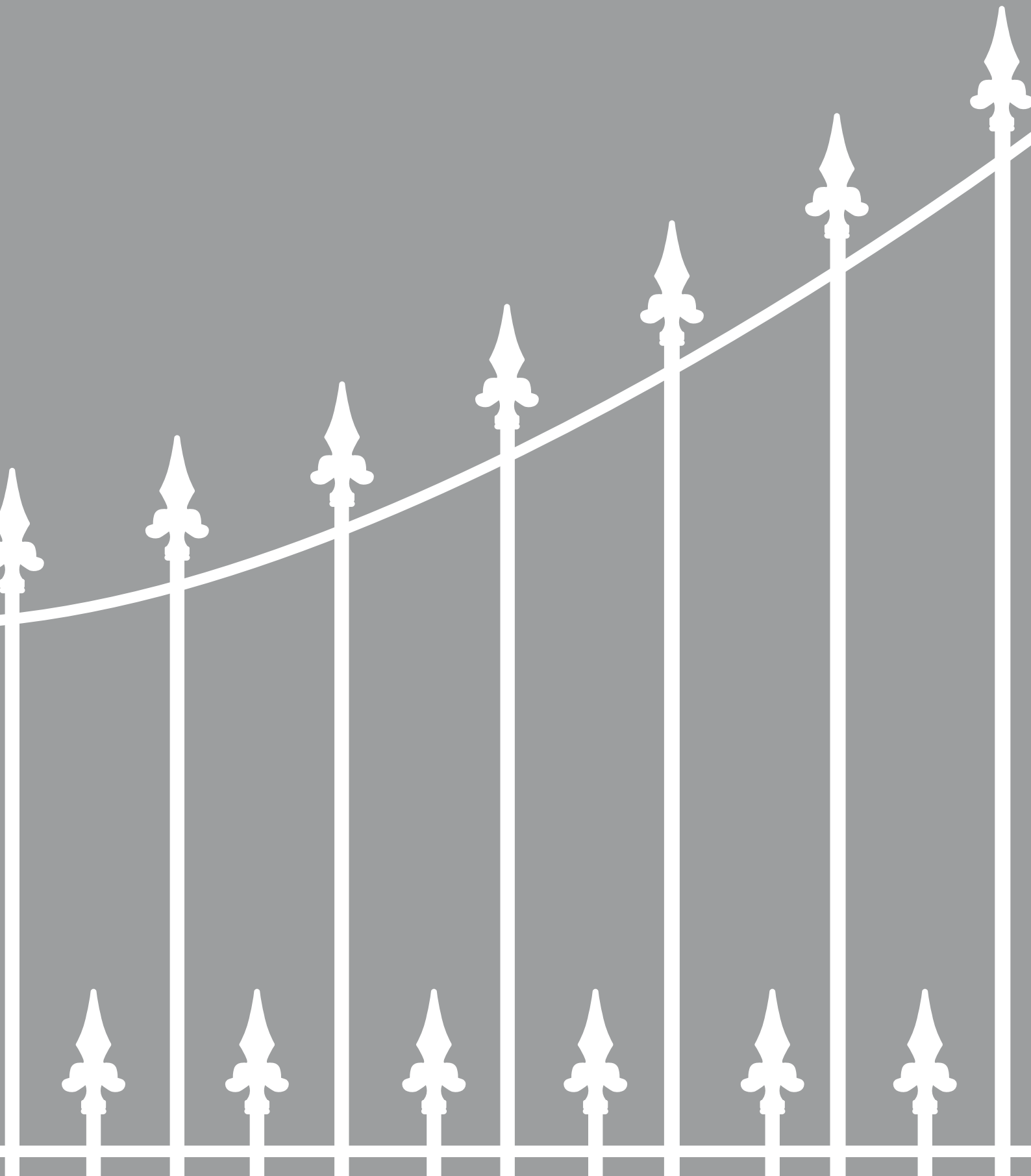

LANCE - SPEAR POINTS

COMPENDIUM 2011

LANCE STAMPATE - HOT STAMPED SPEARS



Art. 125/1
 Ø 35 mm
 H 125 mm



Art. 125/2
 Ø 14 x 14 mm
 H 135 mm



Art. 727/10
 Ø 33 mm
 L 40 mm
 H 150 mm
Art. 727/11
 Ø 30 mm
 L 35 mm
 H 120 mm



Art. 727/1
 Ø 32 mm
 H 140 mm
 L 70 mm
Art. 727/2
 Ø 30 mm
 H 125 mm
 L 65 mm
Art. 727/3
 Ø 25 mm
 H 110 mm
 L 55 mm



Art. 1386/12
 Ø 32 mm
 H 125 mm
 L 60 mm
Art. 1386/13
 Ø 25 mm
 H 110 mm
 L 55 mm



ARTEFERRO



Art. 126/8
 Ø 20 mm
 H 112 mm
Art. 126/21
 Ø 25 mm
 H 135 mm



Art. 124/1
 Ø 12 mm
 H 125 mm
Art. 124/2
 Ø 15 mm
 H 160 mm
Art. 124/9
 Ø 20 mm
 H 190 mm

Art. 731/2
 Ø 15 mm
 H 160 mm
 L 74 mm
**GHISA
 CAST IRON**



Art. 1386/9
 Ø 26 mm
 H 140 mm
 L 70 mm
Art. 1386/10
 Ø 21,5 mm
 H 115 mm
 L 60 mm



Art. 1386/7
 Ø 16 mm
 H 155 mm
 L 70 mm
Art. 1386/8
 Ø 12 mm
 H 130 mm
 L 60 mm

LANCE STAMPATE - HOT STAMPED SPEARS



Art. 124/7
 Ø 14 mm
 H 127 mm



Art. 124/3
 Ø 12 mm
 H 125 mm

Art. 124/4
 Ø 15 mm
 H 160 mm

Art. 124/5
 Ø 16,5 mm
 H 190 mm



Art. 126/B/1
 Ø 19 mm
 H 195 mm
 L 82 mm

Art. 126/B/2
 Ø 16 mm
 H 160 mm
 L 68 mm

Art. 126/B/3
 Ø 13 mm
 H 130 mm
 L 54 mm



Art. 1387/1
 Ø 23 x 23 mm
 H 75 mm



Art. 1387/2
 Ø 27 x 27 mm
 H 100 mm



Art. 1387/3
 Ø 20 x 20 mm
 H 90 mm



Art. 726/6
 Ø 22 mm
 H 120 mm

Art. 726/7
 Ø 26 mm
 H 135 mm



Art. 126/B/6
 Ø 20 mm
 L 45 mm
 H 80 mm

Art. 126/B/7
 Ø 25 mm
 L 125 mm
 H 64 mm

Art. 126/B/8
 Ø 38 mm
 L 140 mm
 H 80 mm



Art. 1855/3
 Ø 32 mm
 H 170 mm
 L 86 mm

Art. 1855/2
 Ø 25 mm
 H 140 mm
 L 70 mm

Art. 1855/1
 Ø 24 mm
 H 128 mm
 L 65 mm



Art. 727/7
 Ø 40 x 40 mm
 H 200 mm
 L 120 mm

Art. 727/8
 Ø 32 x 32 mm
 H 160 mm
 L 90 mm

Art. 727/9
 Ø 25 x 25 mm
 H 120 mm
 L 70 mm



ARTEFERRO



Art. 725/3
 Ø 18 x 18 mm
 H 285 mm



Art. 725/2
 Ø 32 mm
 H 225 mm



Art. 725/5
 base Ø 27 mm
 L 43 mm
 H 220 mm



Art. 726/8
 Ø 28 mm
 H 142 mm
Art. 726/9
 Ø 35 mm
 H 190 mm



Art. 126/B/9
 Ø 22 mm
 L 66 mm
 H 165 mm



Art. 126/C/5
 Ø 25 mm
 L 44 mm
 H 125 mm

Art. 126/C/4
 Ø 33 mm
 L 57 mm
 H 140 mm

Art. 126/C/3
 Ø 40 mm
 L 70 mm
 H 190 mm



ARTEFERRO



ARTEFERRO



Art. 725/1
 Ø 30 mm
 H 165 mm



Art. 725/4
 base Ø 50 mm
 H 235 mm



Art. 727/6
 Ø 24 mm
 L 60 mm
 H 160 mm

Art. 727/5
 Ø 27 mm
 L 70 mm
 H 185 mm

Art. 727/4
 Ø 30 mm
 L 80 mm
 H 210 mm



Art. 126/E/1
 Ø 15 mm
 L 55 mm
 H 150 mm



Art. 1855/4
 Ø 12 mm
 L 60 mm
 H 135 mm



Art. 1855/5
 Ø 12 mm
 L 60 mm
 H 135 mm



Art. 126/A/1
 Ø 15 mm
 L 68 mm
 H 150 mm

LANCE STAMPATE - HOT STAMPED SPEARS



Art. 122/6
 Ø 30 mm
 H 195 mm
 borchia in tubo
 tubolar boss
 Ø 12 mm



Art. 123/6
 Ø 35 mm
 H 180 mm



Art. 126/9
 Ø 20 mm
 H 90 mm



Art. 726/4
 Ø 24 mm
 H 125 mm



Art. 127/1
 Ø 10 x 10 mm
 H 70 mm
Art. 127/2
 Ø 12 x 12 mm
 H 70 mm



Art. 126/C/2
 Ø 12 x 12 mm
 H 140 mm
 L 60 mm



Art. 126/6
 Ø 34 mm
 H 190 mm

Art. 126/19
 Ø 25 mm
 H 140 mm

Art. 126/20
 Ø 30 mm
 H 160 mm



Art. 122/3
 Ø 10 x 4 mm
 H 90 mm



Art. 123/4
 Ø 15 x 10 mm
 H 140 mm



Art. 122/1
 Ø 20 x 8 mm
 H 160 mm



Art. 122/2
 Ø 10 x 4 mm
 H 145 mm



Art. 126/7
 H 90 mm
 L 70 mm

LANCE FORGIATE - HOT FORGED SPEARS



Art. 121/1
 Ø 30 mm
 H 180 mm



Art. 121/2
 Ø 35 mm
 H 205 mm









Art. 121/3
 Ø 35 mm
 H 180 mm





Art. 723/3
 Ø 40 mm
 H 200 mm



Art. 723/2
 Ø 25 mm
 H 115 mm

Forgiate a caldo Hot forged						
Sezione/Section	Cod.art./Art.no.	Cod.art./Art.no.	Cod.art./Art.no.	Cod.art./Art.no.	Cod.art./Art.no.	Cod.art./Art.no.
Φ 12 x 12 mm	129/10 H 165 mm	722/5 H 150 mm	129/8 H 200 mm	722/3 H 200 mm	129/12 H 200 mm	722/1 H 200 mm
Φ 14 x 14 mm	129/9 H 180 mm	722/6 H 170 mm	129/7 H 200 mm	722/4 H 220 mm	129/11 H 230 mm	722/2 H 230 mm
Φ 16 x 16 mm	129/16 H 170 mm	722/7 H 210 mm	129/19 H 220 mm	128/D/9 H 240 mm	129/20 H 230 mm	722/8 H 240 mm
Ø 12 mm	1385/7 H 200 mm	1385/13 H 200 mm	1385/4 H 200 mm	1385/10 H 200 mm		
Ø 14 mm	1385/8 H 200 mm	1385/14 H 200 mm	1385/5 H 200 mm	1385/11 H 200 mm		
Ø 16 mm	1385/9 H 200 mm	1385/15 H 200 mm	1385/46 H 200 mm	1385/12 H 200 mm		

Stampate a freddo Cold stamped			
Sezione/Section	Cod.art./Art.no.	Cod.art./Art.no.	Cod.art./Art.no.
Φ 12 x 12 mm	1765/11 H 200 mm	1765/26 H 200 mm	1765/41 H 200 mm
Φ 14 x 14 mm	1765/16 H 200 mm	1765/31 H 200 mm	1765/46 H 200 mm
Φ 16 x 16 mm	1765/21 H 200 mm	1765/36 H 200 mm	1765/51 H 200 mm

Stampate a caldo Hot stamped	
Sezione/Section	Cod.art./Art.no.
Φ 12 x 12 mm	1386/5 42 x 120 mm
Φ 14 x 14 mm	1386/6 46 x 140 mm
Φ 16 x 16 mm	

**Forgiate a caldo
Hot forged**

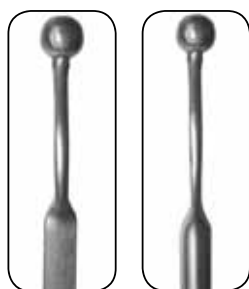

Art. 1764/1
Sez - Sec. Ø 12 mm

A = 80 mm
B = 35 mm
C = Ø 6 mm
D = Ø 14 mm

Art. 1764/3
Sez - Sec. Φ 12 mm

A = 85 mm
B = 35 mm
C = Ø 6 mm
D = Ø 14 mm

Art. 1764/2
Sez - Sec. Ø 14 mm

A = 85 mm
B = 37 mm
C = Ø 7 mm
D = Ø 16 mm

Art. 1764/4
Sez - Sec. Φ 14 mm

A = 85 mm
B = 39 mm
C = Ø 7 mm
D = Ø 18 mm

Art. 1764/3
Sez - Sec. Ø 16 mm

A = 100 mm
B = 42 mm
C = Ø 7 mm
D = Ø 18 mm

Art. 1764/5
Sez - Sec. Φ 16 mm

A = 105 mm
B = 46 mm
C = Ø 7 mm
D = Ø 21 mm

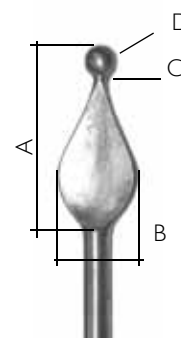

**Forgiate a caldo
Hot forged**

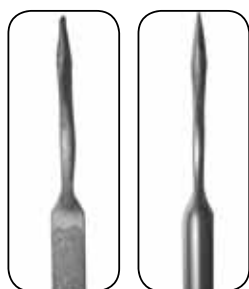

Art. 1764/22
Sez - Sec. Ø 12 mm

A = 77 mm
B = 33 mm

Art. 1764/23
Sez - Sec. Ø 14 mm

A = 86 mm
B = 38 mm

Art. 1764/24
Sez - Sec. Ø 16 mm

A = 92 mm
B = 43 mm

Art. 1764/73
Sez - Sec. Φ 12 mm

A = 75 mm
B = 35 mm

Art. 1764/74
Sez - Sec. Φ 14 mm

A = 87 mm
B = 41 mm

Art. 1764/75
Sez - Sec. Φ 16 mm

A = 95 mm
B = 46 mm

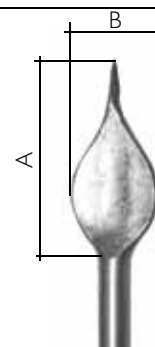

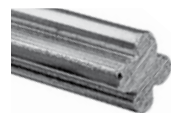
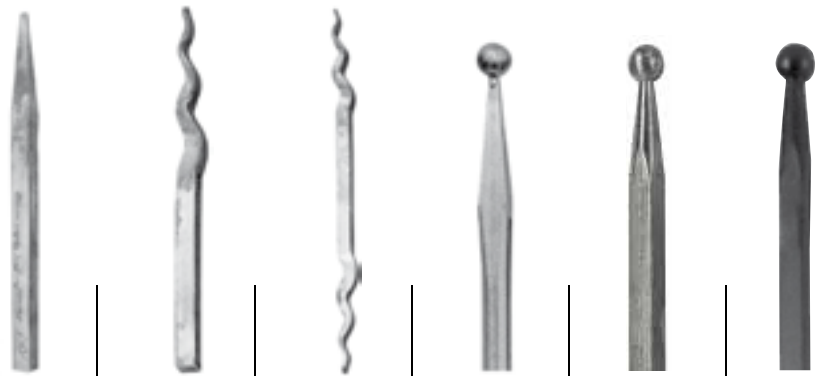

Sezione Section	Cod.art. Art.no.	Cod.art. Art.no.	Cod.art. Art.no.	Cod.art. Art.no.	Cod.art. Art.no.	Cod.art. Art.no.
	H 300 mm	H 300 mm	H 300 mm	H 200 mm	H 200 mm	H 200 mm
12 mm	132/C/12	1381/1	1381/10	1382/21	1759/45	118/C/63
14 mm	132/C/13	1381/2	1381/11	1382/22	1759/46	118/C/64
16 mm	132/C/14	1381/3	1381/12	-	1759/47	C118/C/65
18 mm	-	-	-	-	-	-
20 mm	132/C/15	-	-	-	-	-
22 mm	-	-	-	-	-	-
25 mm	132/C/16	-	-	-	1382/2	-
30 mm	132/C/17	-	-	-	1382/3	-
40 mm	-	-	-	-	1382/1	-
12 mm	132/C/18	1381/7	1381/16	1382/13	-	118/C/66
14 mm	132/C/19	1381/8	1381/17	1382/14	-	118/C/67
16 mm	132/C/20	1381/9	1381/18	-	-	118/C/68
18 mm	132/C/30	-	-	-	-	-
20 mm	132/C/21	-	-	-	-	-
22 mm	132/C/31	-	-	-	-	-
25 mm	132/C/22	-	-	-	1382/4	-
30 mm	132/C/23	-	-	-	1382/5	-
40 mm	-	-	-	-	-	-
12 mm	-	-	-	1382/19	-	-
14 mm	-	-	-	1382/20	-	-
16 mm	-	-	-	-	-	-
18 mm	-	-	-	-	-	-
20 mm	-	-	-	-	-	-
22 mm	-	-	-	-	-	-
25 mm	-	-	-	-	1382/6	-
30 mm	-	-	-	-	1382/7	-
40 mm	-	-	-	-	1382/8	-
12 mm	-	1381/4	1381/13	1382/17	-	-
14 mm	-	1381/5	1381/14	1382/18	-	-
16 mm	-	1381/6	1381/15	-	-	-
25 mm	-	-	-	-	1382/9	-
30 mm	-	-	-	-	1382/10	-
40 mm	-	-	-	-	-	-
12 mm	-	-	-	1382/11	-	-
14 mm	-	-	-	1382/12	-	-
16 mm	-	-	-	-	-	-
12 mm	-	-	-	1382/15	-	-
14 mm	-	-	-	1382/16	-	-
16 mm	-	-	-	-	-	-



ARTEFERRO



Art. 1766/39
 \varnothing 25 x 25 mm
 H 300 mm
Art. 1766/40
 \varnothing 30 x 30 mm
 H 300 mm



Art. 1766/41
 \varnothing 25 x 25 mm
 H 300 mm
Art. 1766/42
 \varnothing 30 x 30 mm
 H 300 mm



Art. 1766/43
 \varnothing 25 x 25 mm
 H 300 mm
Art. 1766/44
 \varnothing 30 x 30 mm
 H 300 mm



Art. 129/6
 \varnothing 12 x 12 mm
 H 100 mm
Art. 129/5
 \varnothing 14 x 14 mm
 H 110 mm



Art. 1766/33
 \varnothing 25 x 25 mm
 H 300 mm
Art. 1764/34
 \varnothing 30 x 30 mm
 H 300 mm



Art. 1766/35
 \varnothing 25 x 25 mm
 H 300 mm
Art. 1766/36
 \varnothing 30 x 30 mm
 H 300 mm



Art. 1766/37
 \varnothing 25 x 25 mm
 H 300 mm
Art. 1766/38
 \varnothing 30 x 30 mm
 H 300 mm



Art. 1754/45
 \varnothing 12 x 12 mm
 H 200 mm
 Medaglia / Medal
 \varnothing 32 mm
Art. 1754/46
 \varnothing 14 x 14 mm
 H 200 mm
 Medaglia / Medal
 \varnothing 35 mm
Art. 1754/47
 \varnothing 16 x 16 mm
 H 200 mm
 Medaglia / Medal
 \varnothing 42 mm



Art. 1765/1
 \varnothing 30 x 8 mm
 H 250 mm



Art. 129/17
 \varnothing 20 x 20 mm
Art. 129/18
 \varnothing 30 x 30 mm

LANCIE - SPEAR POINTS



Art. 121/4
 Ø 33 mm
 H 130 mm



Art. 123/3
 Ø 32 mm
 H 130 mm



Art. 723/4
 Ø 30 mm
 H 130 mm



Art. 723/5
 Ø 28 mm
 H 160 mm



Art. 723/6
 Ø 40 mm
 H 160 mm



Art. 121/6
 Ø 30 x 30 mm
 H 186 mm



Art. 121/8
 Ø 30 x 30 mm
 H 153 mm



Art. 126/18
 Ø 40 x 40 mm
 H 150 mm



Art. 121/5
 Ø 25 x 25 mm
 H 160 mm



Art. 123/5
 Ø 25 x 25 mm
 H 160 mm



Art. 126/2
 Ø 20 x 20 mm
 H 130 mm



Art. 126/1
 Ø 10 x 10 mm
 H 140 mm



Art. 1386/1
 Ø 40 x 40 mm
 H 150 mm

Art. 1386/2
 Ø 32 x 32 mm
 H 135 mm

Art. 1386/3
 Ø 25 x 25 mm
 H 125 mm

Art. 1386/4
 Ø 20 x 20 mm
 H 100 mm



Art. 724/1
 Ø 35 mm
 H 295 mm



ARTEFERRO



ARTEFERRO



Art. 120/3
Ø 30 mm
H 170 mm



Art. 120/2
Ø 35 mm
H 200 mm



Art. 120/1
Ø 40 mm
H 220 mm



Art. 122/B/1
Ø 35 mm
H 170 mm



Art. 1854/9
Ø 32 mm
H 180 mm



Art. 1854/8
Ø 30 mm
H 160 mm



Art. 1854/7
Ø 28 mm
H 160 mm

LANCE STAMPATE - HOT STAMPED SPEARS



Art. 1855/7
Ø 31 mm
H 180 mm
L 60 mm

Art. 1855/6
Ø 26 mm
L 48 mm
H 150 mm



Art. 122/A/1
Ø 35 mm
H 200 mm



Art. 726/3
Ø 30 mm
H 180 mm



Art. 1855/8
Ø 40 mm
H 220 mm



Art. 1855/9
Ø 35 mm
H 200 mm



Art. 1855/10
Ø 35 mm
H 200 mm



Art. 126/13
 Ø 16 mm
 L 64 mm
 H 170 mm



Art. 126/C/9
 Ø 40 mm
 L 80 mm
 H 150 mm



Art. 126/B/4
 Ø 20 mm
 L 70 mm
 H 130 mm



Art. 124/6
 Ø 15 mm
 H 155 mm



Art. 1386/11
 Ø 16 mm
 L 65 mm
 H 150 mm



Art. 126/5
 Ø 20 x 20 mm
 H 160 mm

Art. 126/14
 Ø 14 mm
 L 55 mm
 H 140 mm



Art. 726/5
 Ø 13 mm
 L 48 mm
 H 140 mm



Art. 126/C/1
 Ø 24 mm
 L 70 mm
 H 155 mm



Art. 126/E/2
 Ø 16 mm
 L 90 mm
 H 160 mm



Art. 126/B/5
 Ø 50 mm
 L 85 mm
 H 165 mm



Art. 726/19
 Ø 14 x 14 mm
 L 80 mm
 H 140 mm



Art. 726/12
 Ø 18 mm
 H 110 mm

Art. 124/8
 Ø 15 mm
 H 215 mm



Art. 726/13
 Ø 23 mm
 H 140 mm



Art. 110/9
 Ø 43 mm
 H 210 mm



Art. 129/15
 Ø 32 mm
 H 180 mm



Art. 123/7
 Ø 40 mm
 H 200 mm



Art. 126/17
 Ø 25 x 25 mm
 H 290 mm

forgiata
 hot forged

LANCE in GHISA MALLEABILE Saldabile - Non Zincabile
Malleable, Weldable CAST IRON SPEARS Galvanizing is not recommended



Art. 735/1
 ϕ 14 x 14 mm
 L 27 mm
 H 140 mm
 Foro-Hole ϕ 14 mm



Art. 735/2
 ϕ 14 x 14 mm
 L 20 mm
 H 115 mm
 Foro-Hole ϕ 14 mm



Art. 735/3
 ϕ 14 x 14 mm
 L 25 mm
 H 155 mm
 Foro-Hole ϕ 14 mm



Art. 736/1
 ϕ 14 x 14 mm
 L 28 mm
 H 140 mm
 Foro-Hole ϕ 14 mm



Art. 736/2
 ϕ 14 x 14 mm
 L 25 mm
 H 140 mm
 Foro-Hole ϕ 14 mm



Art. 736/3
 ϕ 14 mm
 L 30 mm
 H 140 mm
 Foro-Hole ϕ 14 mm



Art. 731/4
 ϕ 15 mm
 L 68 mm
 H 150 mm



Art. 731/3
 ϕ 15 mm
 L 55 mm
 H 150 mm



Art. 731/1
 ϕ 16 mm
 L 64 mm
 H 170 mm



Art. 734/1
 ϕ 14 mm
 L 25 mm
 H 135 mm
 Foro-Hole ϕ 14 mm



Art. 733/1
 ϕ 20 x 20 mm
 L 35 mm
 H 155 mm
 Foro-Hole ϕ 20 mm



Art. 731/5
 ϕ 12 x 12 mm
 L 23 mm
 H 110 mm
 Foro-Hole ϕ 12 mm



Art. 732/1
 ϕ 12 x 12 mm
 L 23 mm
 H 135 mm
 Foro-Hole ϕ 12 mm

Art. 734/2
 ϕ 12 mm
 L 25 mm
 H 100 mm
 Foro-Hole ϕ 12 mm

Art. 733/2
 ϕ 25 x 25 mm
 L 45 mm
 H 205 mm
 Foro-Hole ϕ 25 mm



ARTEFERRO

Art. 731/6
 ϕ 16 x 16 mm
 L 25 mm
 H 110 mm
 Foro-Hole ϕ 16 mm

Art. 732/2
 ϕ 16 x 16 mm
 L 25 mm
 H 135 mm
 Foro-Hole ϕ 16 mm

Art. 734/3
 ϕ 14 x 14 mm
 L 24 mm
 H 103 mm
 Foro-Hole ϕ 14 mm

Art. 733/3
 ϕ 12 x 12 mm
 L 23 mm
 H 110 mm
 Foro-Hole ϕ 12 mm

Art. 731/7
 ϕ 18 x 18 mm
 L 30 mm
 H 110 mm
 Foro-Hole ϕ 18 mm

Art. 732/3
 ϕ 18 x 18 mm
 L 25 mm
 H 135 mm
 Foro-Hole ϕ 18 mm

Art. 733/4
 ϕ 16 x 16 mm
 L 25 mm
 H 110 mm
 Foro-Hole ϕ 16 mm

Art. 733/5
 ϕ 18 x 18 mm
 L 30 mm
 H 110 mm
 Foro-Hole ϕ 18 mm



Art. 574/14
 \varnothing 12 x 12 mm
 H 250 mm
Art. 574/15
 \varnothing 14 x 14 mm
 H 250 mm



Art. 574/12
 \varnothing 12 x 12 mm
 H 250 mm
Art. 574/13
 \varnothing 14 x 14 mm
 H 250 mm



Art. 88/L/2
 \varnothing 14 x 8 mm
 H 135 mm



Art. 751/6
 \varnothing 12 x 6 mm
 H 300 mm



Art. 1722/1
 \varnothing 10 mm
 H 150 mm



Art. 89/4
 \varnothing 8 x 8 mm
 H 55 mm



Art. 1846/2
 \varnothing 10 mm
 H 140 mm

Art. 751/7
 \varnothing 16 x 4 mm
 H 300 mm

Art. 751/8
 \varnothing 20 x 4 mm
 H 300 mm

Art. 751/9
 \varnothing 20 x 6 mm
 H 300 mm



Art. 574/11
 \varnothing 14 mm
 H 250 mm



Art. 574/10
 \varnothing 14 mm
 H 250 mm



Art. 751/4
 \varnothing 18 mm
 H 195 mm



Art. 129/14
 \varnothing 12 x 12 mm
 H 200 mm



ARTEFERRO



ARTEFERRO



Art. 129/1
 ϕ 14 x 14 mm
 H 200 mm



Art. 129/3
 ϕ 14 x 14 mm
 H 190 mm



Art. 1380/1
 ϕ 20 mm
 H 250 mm



Art. 44/1
 ϕ 14 x 14 mm
 H 200 mm

Art. 44/4
 ϕ 20 x 20 mm
 H 200 mm

Art. 129/2
 ϕ 12 x 12 mm
 H 190 mm

Art. 129/4
 ϕ 12 x 12 mm
 H 180 mm

Art. 1380/2
 ϕ 14 mm
 H 250 mm

Art. 44/2
 ϕ 16 x 16 mm
 H 200 mm

Art. 44/5
 ϕ 22 x 22 mm
 H 200 mm

Art. 44/3
 ϕ 18 x 18 mm
 H 200 mm

Art. 44/6
 ϕ 25 x 25 mm
 H 200 mm

Art. 44/7
 ϕ 30 x 30 mm
 H 200 mm



Art. 723/1
 ϕ 30 x 30 mm
 L 130 mm
 H 165 mm



Art. 126/D/1
 ϕ 18 x 18 mm
 L 60 mm
 H 155 mm

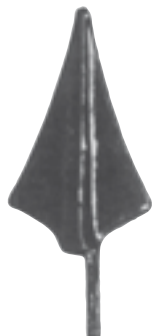

Art. 190/5
 L 62 mm
 H 144 mm



Art. 125/4
 ϕ 20 mm
 H 130 mm



Art. 125/3
 ϕ 35 mm
 H 150 mm



Art. 726/1
 ϕ 12 x 12 mm
 H 185 mm



Art. 726/2
 ϕ 12 x 12 mm
 H 165 mm



Art. 1765/2
 ϕ 30 x 8 mm
 H 250 mm



Art. 1765/3
 ϕ 30 x 8 mm
 H 250 mm



Art. 1765/4
 ϕ 20 x 6 mm
 H 200 mm



Art. 126/C/6
 ϕ 23 mm
 70 x 160 mm



Art. 126/C/7
 ϕ 18 mm
 H 125 mm



Art. 122/4
 ϕ 28 mm
 H 35 mm

Art. 122/5
 ϕ 30 mm
 H 55 mm



Art. 123/2
 ϕ 40 mm
 H 60 mm



Art. 726/18
 ϕ 17 x 17 mm
 L 50 mm
 H 170 mm



Art. 1385/1
 ϕ 12 x 12 mm
 H 150 mm
 L 30 mm

Art. 1385/2
 ϕ 14 x 14 mm
 H 150 mm
 L 35 mm

Art. 1385/3
 ϕ 16 x 16 mm
 H 150 mm
 L 40 mm

LANCE - SPEAR POINTS

LANCE - SPEAR POINTS

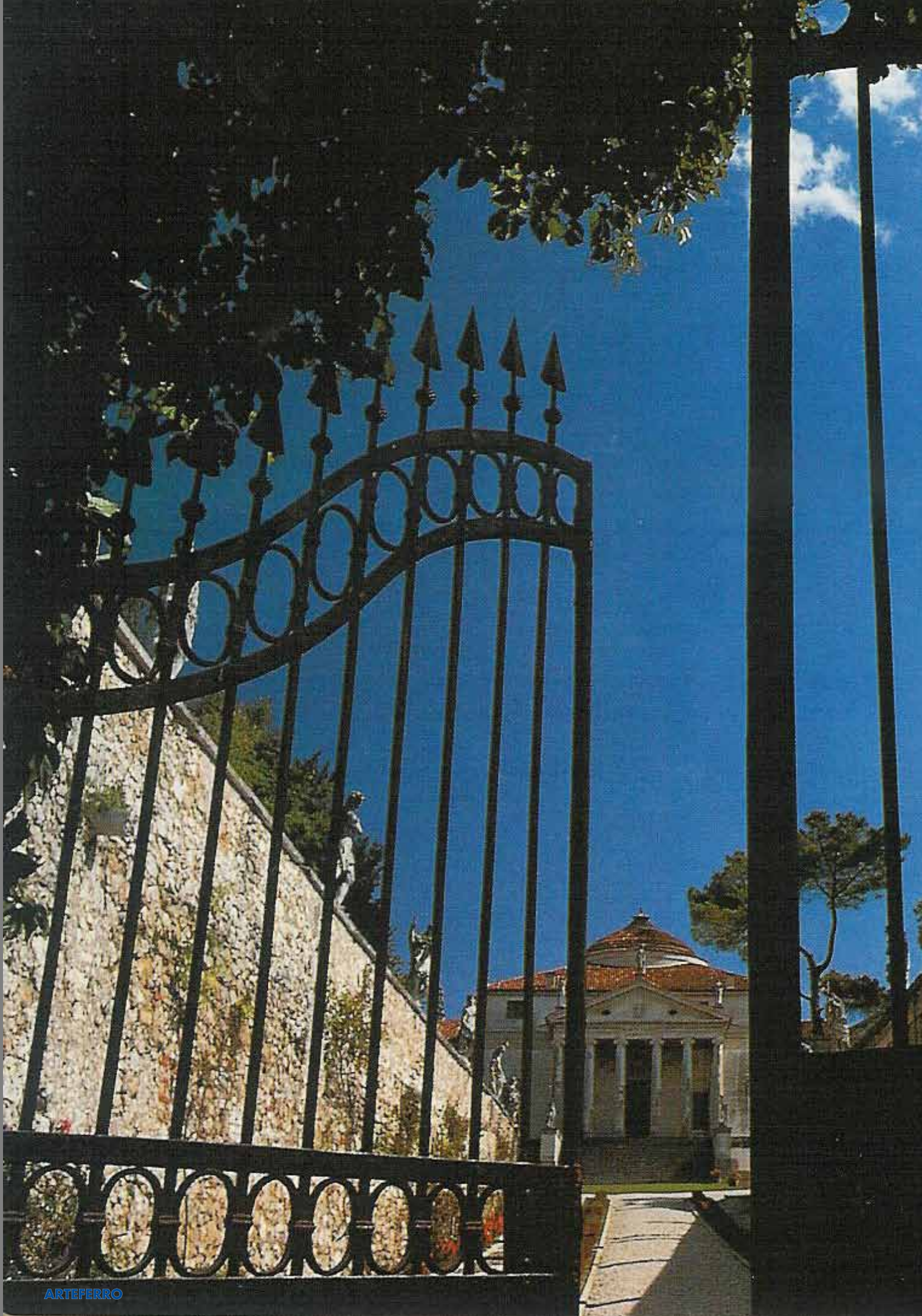

ARTEFERRO

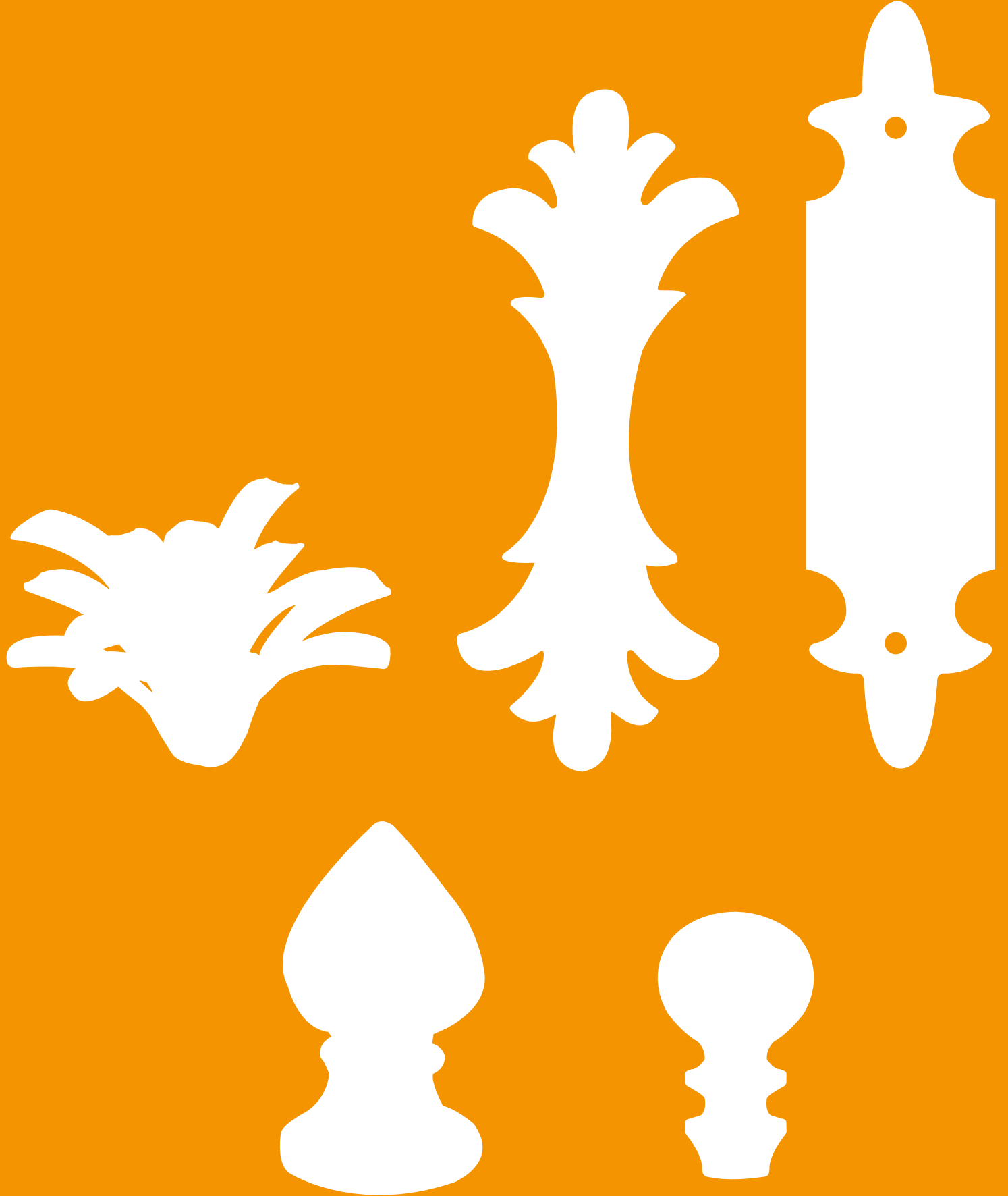

POMOLI E PIASTRE - TOPS AND PLATES

COMPENDIUM 2011

Art. 749/2
Art. 1400/1
Art. 128/1
Art. NEW0049

POMOLI FORGIATI - HAND FORGED POST TOPS



Art. 749/22
Ø 70 mm



Art. 116/A/20
sfera/sphere Ø 55 mm
base Ø 38 mm



Art. 116/A/21
sfera/sphere Ø 40 mm
base Ø 26 mm



Art. 116/A/22
sfera/sphere Ø 40 mm
base Ø 26 mm



Art. 113/9
Ø 75 mm



Art. 113/10
Ø 70 mm



Art. 749/2
Ø 24 mm
H 95 mm



Art. 116/A/17
Ø 72 mm

Art. 116/A/19
Ø 55 mm



Art. 116/A/18
Ø 60 mm



Art. 749/1
Ø 35 mm
H 155 mm

POMOLI STAMPATI STAMPED POST TOPS



Art. 1398/2
 Φ 16 x 16 mm
 H 115 mm
 Φ 90 mm



Art. 1399/1
 H 140 mm
 base Φ 25 mm
 Φ 115 mm



Art. 1400/1
 H 100 mm
 base Φ 25 mm
 Φ 160 mm



Art. 1398/1
 H 75 mm
 Φ 120 mm



Art. 1400/2
 H 130 mm
 base Φ 30 mm
 Φ 120 mm



Cod.art./Art.no.	Sfera/Sphere Φ /dia.	Base Φ /dia.	H
1404/1	110 mm	90 mm	140 mm
1404/2	90 mm	70 mm	125 mm
1404/3	70 mm	55 mm	100 mm
1404/4	55 mm	45 mm	85 mm



Cod.art./Art.no.	Sfera/Sphere Φ /dia.	Base	H
1404/5	95 mm	100 x 100 mm	150 mm
1404/6	85 mm	80 x 80 mm	120 mm
1404/7	70 mm	60 x 60 mm	105 mm
1404/8	50 mm	40 x 40 mm	75 mm
1404/9	30 mm	25 x 25 mm	45 mm



Cod.art./Art.no.	Sfera/Sphere Φ /dia.	Base	H
128/31	10 mm	-	180 mm



ARTEFERRO



Lato/Side	Foro/Hole	Cod.art./Art.no.
40 x 40 mm	senza foro/without hole	819/11
	per/for Φ 12 x 12 mm	819/8
	per/for Φ 14 x 14 mm	819/7
	per/for Φ 16 x 16 mm	819/6
50 x 50 mm	senza foro/without hole	819/10
	per/for Φ 16 x 16 mm	819/5
	per/for Φ 18 x 18 mm	819/4
	per/for Φ 20 x 20 mm	819/3
60 x 60 mm	senza foro/without hole	819/9
	per/for Φ 25 x 25 mm	819/2
	per/for Φ 30 x 30 mm	819/1
80 x 80 mm	senza foro/without hole	819/17
	per/for Φ 25 x 25 mm	819/18
	per/for Φ 30 x 30 mm	819/15
	per/for Φ 40 x 40 mm	819/16

Φ esterno External dia.	Foro/Hole	Cod.art./Art.no.
30 mm	senza foro/without hole	1408/18
	per/for Φ 12 mm	1408/21
40 mm	senza foro/without hole	1408/17
	per/for Φ 12 mm	1408/5
	per/for Φ 14 mm	1408/19
50 mm	per/for Φ 16 mm	1408/20
	senza foro/without hole	1408/16
	per/for Φ 18 mm	1408/13
60 mm	per/for Φ 20 mm	1408/12
	senza foro/without hole	1408/15
	per/for Φ 25 mm	1408/7
80 mm	per/for Φ 30 mm	1408/6
	senza foro/without hole	1408/14
	per/for Φ 30 mm	1408/10
	per/for Φ 35 mm	1408/9
	per/for Φ 40 mm	1408/8



Art. 116/A/7
100 x 100 mm
foro/hole
 Φ 30 x 30 mm
spess./thickn. 10 mm

Art. 116/A/6
100 x 100 mm
senza foro
without hole
spess./thickn. 10 mm



ARTEFERRO



Art. 116/A/1
70 x 70 mm
Foro/Hole
Φ 13 x 13 mm
Spess./Thickn. 5 mm



Art. 116/35
Ø 65 mm
Foro/Hole
Ø 15 mm
Spess./Thickn. 8 mm



Art. 1393/7
Foro/Hole Ø 12,5 mm
Spessore/Thickness 10 mm
Ø 68 mm

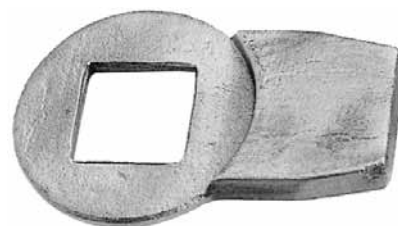

Art. 609/1
Ø 70 mm
30 ÷ 40 x 8 mm
Foro/Hole
Φ 30 x 30 mm

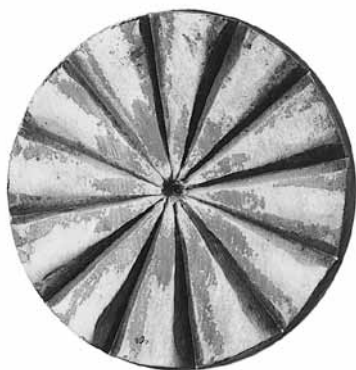

Art. 654/5
Ø 60 mm
Spess./Thickn. 6 mm



Art. 1857/13
Ø 82 mm
Spess./Thickn. 4 mm



Art. 1857/14
Ø 82 mm
Foro/Hole
Ø 8,5 mm
Spess./Thickn. 4 mm



ARTEFERRO



Art. 1857/15
Ø 82 mm
Foro/Hole
Ø 15 mm
Spess./Thickn. 4 mm
H 10 mm



Art. 138/2
Spessore/Thickness 2 mm
5 mm x Ø 60 mm



Art. 94/A/3
100 x 100 mm
Spess./Thickn. 8 mm



Art. 94/A/4
80 x 80 mm
Spess./Thickn. 8 mm

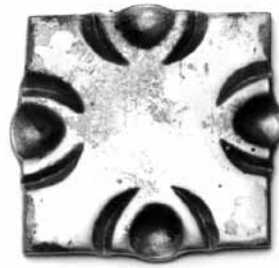

Art. 94/A/5
80 x 80 mm
Spess./Thickn. 8 mm

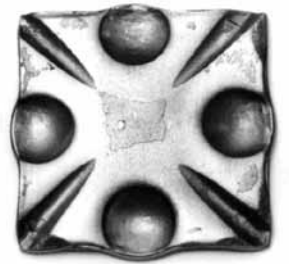

Art. 94/A/6
80 x 80 mm
Spess./Thickn. 8 mm



Art. 147/3
Kit di 4 pezzi per bloccaggio a
pavimento tubi da 40 mm
Kit comprises of base screw and
cover tube dia 40 mm

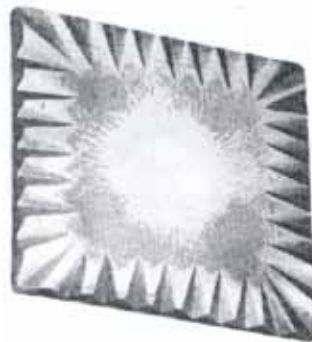

Art. 181/6
120 x 120 mm
Spess./Thickn. 8 mm

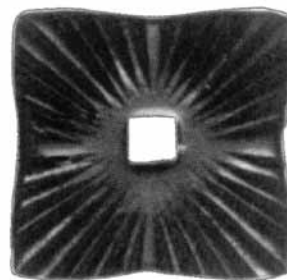

Art. 116/A/2
75 x 75 mm
Foro/Hole
Φ 13 x 13 mm
Spess./Thickn. 5 mm



Art. 1408/1
L 80 x 80 mm
Foro/Hole
Φ 26 x 26 mm
H 18 mm



Art. 1393/3
Ø 75 mm
Spess./Thickn. 20 mm

Art. 1408/2
L 55 x 55 mm
Foro/Hole
Φ 15 x 15 mm
H 12 mm



Art. 802/5
70 x 70 mm
Spess./Thickn. 6 mm



Art. 802/4
100 x 100 mm
Spess./Thickn. 10 mm



ARTEFERRO



Art. NEW0049

∅ 6 mm
H 280 mm
L 130 mm

Art. NEW0050

∅ 6 mm
H 220 mm
L 100 mm



Art. NEW0054

Base 35 mm
∅ 6 mm
H 140 mm
L 130 mm

Art. NEW0055

Base 32 mm
∅ 6 mm
H 110 mm
L 100 mm



Art. 94/A/7

H 165 mm
L 100 mm

Art. 94/A/8

H 150 mm
L 85 mm

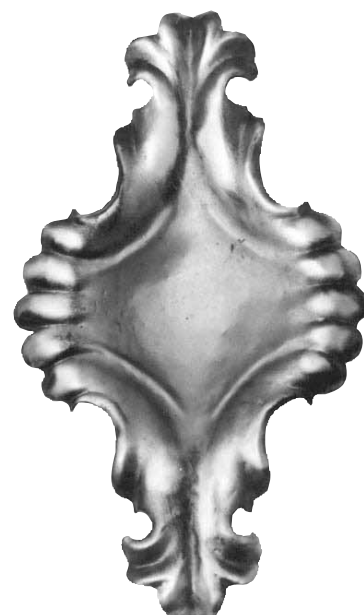

Art. 137/14

H 355 mm
L 130 mm
Spess./Thickn. 1 mm



Art. 137/13

H 190 mm
L 140 mm
Spess./Thickn. 1 mm



Art. 1470/8

H 300 mm
L 75 mm
Spess./Thickn. 3 mm

Art. 841/7

H 520 mm
L 75 mm
Spess./Thickn. 3 mm

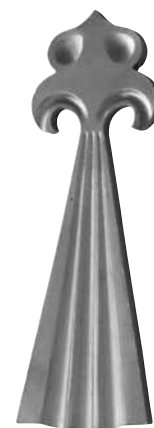

NEW0051

∅ 8 mm
80 x H 235 mm



Art. 137/12

H 260 mm
L 145 mm
Spess./Thickn. 1 mm



Art. 1470/9

H 220 mm
L 75 mm
Spess./Thickn. 3 mm



Art. 701/10

H 280 mm
L 65 mm

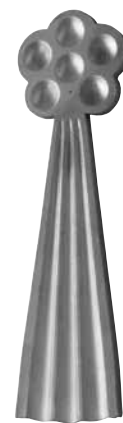

NEW0052

∅ 8 mm
65 x H 220 mm



Art. 1857/5
100 × 100 mm
Spess./Thickn. 8 mm



Art. 1857/7
100 × 100 mm
Spess./Thickn. 8 mm

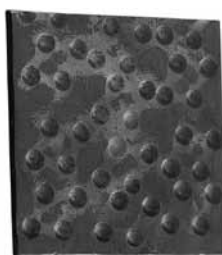

Art. 1408/4
160 × 160 mm
Spess./Thickn. 10 mm



Art. 1408/3
Ø 160 mm
Spess./Thickn. 10 mm

Art. 1857/6
120 × 120 mm
Spess./Thickn. 8 mm

Art. 1857/8
120 × 120 mm
Spess./Thickn. 8 mm



Art. 1860/6
Ø 414 mm
H 44 mm
Spess./Thickn. 4 mm



Art. 1860/1
Ø 580 mm
H 45 mm
Spess./Thickn. 6 mm



Art. 1860/4
Ø 360 mm
H 31,5 mm
Spess./Thickn. 3 mm



Art. 1861/21
base 143 × 143 mm
H 14 mm
Spess./Thickn. 6 mm

Art. 1860/2
Ø 680 mm
H 50 mm
Spess./Thickn. 8 mm

Art. 1860/5
Ø 415 mm
H 33 mm
Spess./Thickn. 4 mm

Art. 1861/22
base 200 × 200 mm
H 19 mm
Spess./Thickn. 6 mm

Art. 1860/3
Ø 780 mm
H 55 mm
Spess./Thickn. 8 mm



Cod.art./Art.no.	Ø/diameter	H	Spessore/Thickness
1861/1	170 mm	20 mm	3 mm
1861/2	200 mm	25 mm	4 mm
1861/3	220 mm	32 mm	4 mm
1861/4	240 mm	25 mm	6 mm
1861/5	260 mm	28 mm	6 mm
1861/6	290 mm	31 mm	6 mm
1861/7	320 mm	32 mm	6 mm
1861/8	370 mm	38 mm	5 mm
1861/9	500 mm	28 mm	5 mm

Cod.art./Art.no.	Ø/diameter	H	Spessore/Thickness
1861/10	120 mm	13 mm	3 mm
1861/11	140 mm	13 mm	3 mm
1861/12	160 mm	16 mm	4 mm
1861/13	185 mm	21 mm	3 mm
1861/14	200 mm	20 mm	4 mm
1861/15	230 mm	35 mm	6 mm
1861/16	265 mm	30 mm	3,5 mm
1861/17	295 mm	40 mm	6 mm
1861/18	340 mm	35 mm	6 mm
1861/19	380 mm	35 mm	6 mm
1861/20	480 mm	40 mm	6 mm



FIORI E ORNAMENTI - FLOWERS AND ORNAMENTS

COMPENDIUM 2011

Art. 140/H/3
Art. 661/4
Art. 673/1



Art. 697/3
 Ø 95 mm
 Spessore/Thickness
 3 mm



Art. 697/4
 Ø 65 mm
 Spessore/Thickness
 3 mm



Art. 116/A/3
 Ø 95 mm
 Spessore/Thickness
 3 mm



Art. 116/A/4
 Ø 65 mm
 Spessore/Thickness
 3 mm

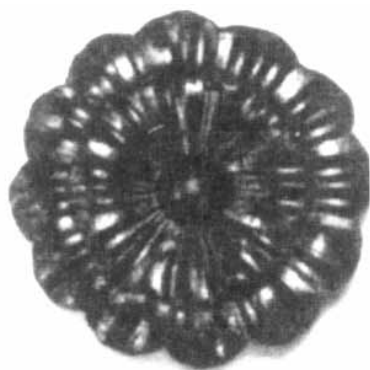

Art. 116/A/5
 Ø 95 mm
 Spessore/Thickness
 3 mm + 3 mm



Ferro fuso/Cast Steel
Art. 664/2
 Ø 90 mm
 Foro / Hole Ø 16 mm
 Spessore/Thickness
 3 mm



Ferro fuso/Cast Steel
Art. 664/1
 Ø 60 mm
 Foro / Hole Ø 8 mm
 Spessore/Thickness
 3 mm



ARTEFERRO



Art. 136/3
70 x 60 mm
Spessore/Thickness
3 mm



Art. 136/4
70 x 60 mm
Spessore/Thickness
3 mm



Art. 136/1
110 x 40 mm
Spessore/Thickness
3 mm



Art. 136/2
110 x 40 mm
Spessore/Thickness
3 mm



Art. 136/10
160 x 70 mm
Spessore/Thickness
3 mm



Art. 136/11
160 x 70 mm
Spessore/Thickness
3 mm



Art. 136/13
90 x 30 mm
Spessore/Thickness
3 mm



Art. 136/12
90 x 30 mm
Spessore/Thickness
3 mm



Art. 140/H/3
125 x 90 mm
Spessore/Thickness
5 mm

Art. 140/H/4
195 x 150 mm
Spessore/Thickness
5 mm



Ferro fuso/Cast steel
Art. 661/3
Ø 8 mm
155 x 110 mm



Ferro fuso/Cast steel
Art. 661/4
Ø 8 mm
125 x 75 mm



Art. 138/13
195 x 190 mm
Spessore/Thickness
0,5 mm



Art. 709/11
72 x 72 mm
Spessore/Thickness
0,3 mm



Art. 138/12
105 x 95 mm
Spessore/Thickness
0,5 mm



Art. 709/7
39 x 36 mm
Spessore/Thickness
0,3 mm

Art. 709/9
56 x 54 mm
Spessore/Thickness
0,3 mm



Art. 138/11
75 x 70 mm
Spessore/Thickness
0,5 mm



ARTEFERRO



Forgiato /Hand forged

Art. 673/1
270 x 130 mm



Forgiato /Hand forged

Art. 140/H/1
270 x 130 mm

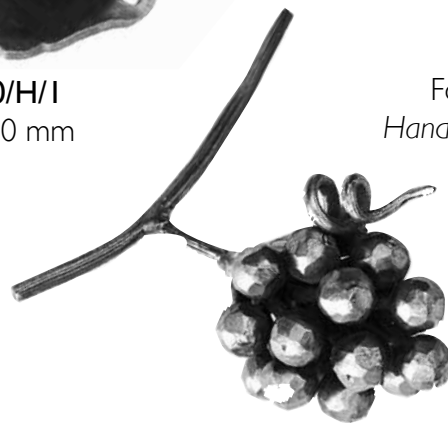

Forgiato
Hand forged

Art. 673/2
170 x 90 mm



Forgiato
Hand forged



Art. 673/3
Ø 6 mm
H 150 mm

Art. 140/H/2
170 x 90 mm



Art. 137/7
130 x 65 mm
Spessore/Thickness
0,5 mm



Art. 137/8
90 x 50 mm
Spessore/Thickness
0,5 mm



Art. 138/3
17 mm - Ø 88 mm
Spessore/Thickness
2 mm



Art. 711/1
15 mm - Ø 85 mm
Spessore/Thickness
1 mm

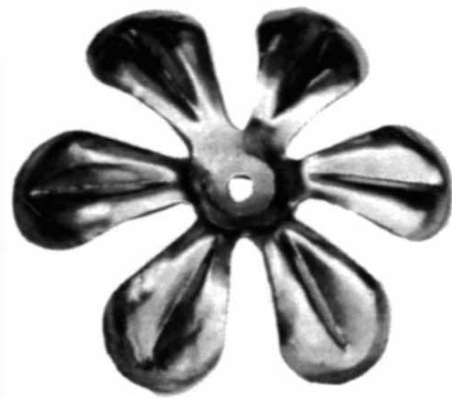

Art. 138/5
15 mm - Ø 90 mm
Spessore/Thickness
0,3 mm



Art. 138/4
10 mm - Ø 90 mm
Spessore/Thickness
2 mm

Art. 711/3
Ø 140 mm
Spessore/Thickness
2 mm

Art. 711/2
10 mm - Ø 68 mm
Spessore/Thickness
1 mm

Art. 138/6
10 mm - Ø 55 mm
Spessore/Thickness
0,3 mm

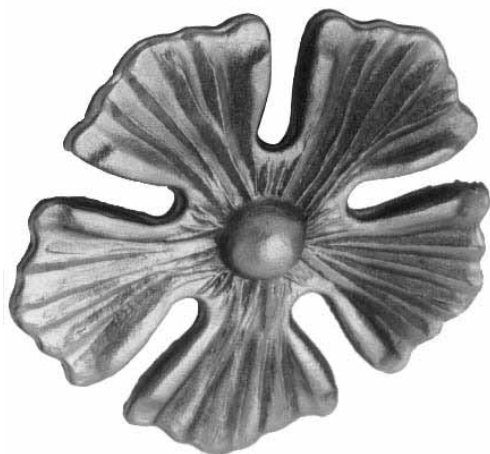

Art. 138/14
Ø 120 mm
Spessore/Thickness
4 mm



ARTEFERRO

Foglie Forgiate Hand forged Leaves



Art. 675/3
200 x 55 mm
Spessore/Thickness
4 mm



Art. 675/2
240 x 65 mm
Spessore/Thickness
4 mm



Art. 692/8
330 x 100 mm
Spessore/Thickness
4 mm



Art. 675/1
320 x 75 mm
Spessore/Thickness
4 mm



ARTEFERRO



ARTEFERRO



Art. 692/9
180 x 50 mm
Spessore/Thickness
4 mm



Art. 675/4
150 x 45 mm
Spessore/Thickness
4 mm



Art. 700/2
 Ø 6 mm
 H 320 mm



Art. 700/9
 Ø 6 mm
 H 320 mm

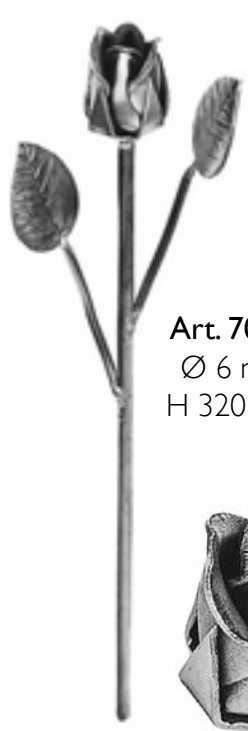

Art. 700/7
 Ø 6 mm
 H 320 mm

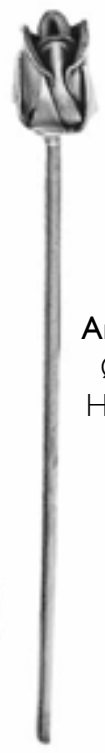

Art. 700/10
 Ø 6 mm
 H 320 mm



Art. 700/1
 45 mm - Ø 60 mm
 Spessore/Thickness
 1 mm



Art. 700/5
 H 45 mm - Ø 30 mm
 Spessore/Thickness
 1 mm



Art. 1329/6
 Ø 8 mm
 500 x 130 mm



Art. 140/1/3
 68 mm - Ø 60 mm
 Spessore/Thickness
 4 mm



Art. 700/4
 Ø 5 mm
 H 300 mm
 Grezzo
 Raw
Art. 160/E/10
 H 260 mm
 Verniciato
 Painted



ARTEFERRO



Art. 1328/3
Gambo/Stam
Ø 60 mm
H 200 x L 45 mm



Art. 700/6
H 45 x L 30 mm
Spessore/Thickness
1 mm



Art. 702/1
H 110 x L 62 mm
Spessore/Thickness
0,5 mm



Art. 140/1/2
H 110 x L 50 mm
Spessore/Thickness 4 mm



Art. 604/12
H 80 x L 32 mm
Spessore/Thickness
2,5 mm



Art. 604/11
H 45 x L 32 mm
Spessore/Thickness
2,5 mm



Art. 702/3
H 200 x L 80 mm
Spessore/Thickness
0,5 mm



Art. 709/19
225 x 30 mm
Spess./Thick. 0,3 mm



Art. 138/8
H 60 x L 28 mm
Spessore/Thickness
0,3 mm



Art. 140/1
H 55 x L 25 mm
Spessore/Thickness
0,5 mm



Art. 700/3
Ø 4 mm
H 200 x L 45 mm



Art. 706/1
65 x 25 mm
Spess./Thick. 0,3 mm



Art. 706/3
98 x 37 mm
Spess./Thick. 0,3 mm

Art. 138/9
H 70 x L 35 mm
Spessore/Thickness
0,3 mm

Art. 140/2
H 62 x L 29 mm
Spessore/Thickness
0,5 mm

Art. 138/10
H 85 x L 45 mm
Spessore/Thickness
0,3 mm

Art. 140/3
H 80 x L 37 mm
Spessore/Thickness
0,5 mm



Art. NEW0058
Ø 2,5 mm
H 60 x L 56 mm



Art. 706/19
H 45 x L 24 mm
Spessore/Thickness
0,3 mm



Art. 700/8
Ø 4 mm
H 180 mm



Art. 706/5
130 x 50 mm
Spess./Thick. 0,3 mm



Art. 706/15
70 x 29 mm
Spess./Thick. 0,3 mm



Art. 702/2
H 65 x L 52 mm
Spessore/Thickness
0,5 mm

Art. 706/21
H 62 x L 34 mm
Spessore/Thickness
0,3 mm

Art. 706/23
H 81 x L 41 mm
Spessore/Thickness
0,3 mm



Art. 662/1

Ø 16 x 8 mm
H 220 x L 105 mm



Art. 662/2

Ø 16 x 8 mm
H 220 x L 105 mm



Art. 662/5

Ø 16 x 6 mm
H 250 x L 150 mm



Art. 662/6

Ø 16 x 6 mm
H 250 x L 150 mm

Foglie in Ferro fuso
Cast steel Leaves



Art. 663/1

Ø 16 x 6 mm
H 140 x L 110 mm



Art. 663/2

Ø 16 x 6 mm
H 140 x L 110 mm



Art. 661/1

Ø 16 x 6 mm
H 155 x L 140 mm



Art. 661/2

Ø 16 x 6 mm
H 155 x L 140 mm



Art. 662/3

Ø 12 mm
H 130 x L 65 mm



Art. 662/4

Ø 12 mm
H 130 x L 65 mm



Art. 689/9
 Ø 12 mm
 200 x 150 mm
 Spessore/Thickness
 5 mm



Art. 689/10
 Ø 12 mm
 200 x 150 mm
 Spessore/Thickness
 5 mm



Art. 689/7
 Ø 12 mm
 160 x 100 mm
 Spessore/Thickness
 5 mm



Art. 689/8
 Ø 12 mm
 160 x 100 mm
 Spessore/Thickness
 5 mm



Art. 94/B/13
 180 x 150 mm
 Spessore/Thickness
 4 mm



Art. 94/B/14
 180 x 150 mm
 Spessore/Thickness
 4 mm



Art. 94/B/11
 180 x 130 mm
 Spessore/Thickness
 4 mm



Art. 94/B/12
 180 x 130 mm
 Spessore/Thickness
 4 mm



Art. 691/2
 Ø 12 mm
 100 x 160 mm
 Spessore/Thickness
 5 mm



Art. 691/1
 Ø 12 mm
 100 x 160 mm
 Spessore/Thickness
 5 mm



Art. 94/B/15
 150 x 160 mm
 Spessore/Thickness
 4 mm



Art. 94/B/16
 150 x 160 mm
 Spessore/Thickness
 4 mm



Art. 94/B/9
 120 x 85 mm
 Spessore/Thickness
 4 mm



Art. 94/B/10
 120 x 85 mm
 Spessore/Thickness
 4 mm



Art. 94/B/7
 90 x 65 mm
 Spessore/Thickness
 4 mm



Art. 94/B/8
 90 x 65 mm
 Spessore/Thickness
 4 mm



Art. 138/15
 Ø 60 mm
 Spessore/Thickness
 2 mm



Zincato con staffa
Galvanized with stirrup
Art. 190/6
 Ø 60 mm



Art. 138/1
 10 mm - Ø 60 mm
 Spessore/Thickness
 2 mm



Art. 701/1
 Ø 38 mm
 Spessore/Thickness
 0,4 mm

Ghisa / Cast iron



Art. 756/4
 Ø 100 mm
 Filetto/Thread hole M6



Art. 756/12
 Ø 135 mm
 Filetto/Thread hole M5
 Spessore/Thickness
 12 mm



Art. 1393/8
 Ø 90 mm
 Spessore/Thickness 8 mm

Art. 756/13
 Ø 115 mm
 Filetto/Thread hole M5
 Spessore/Thickness
 12 mm

Art. 1393/9
 Ø 55 mm
 Spessore/Thickness 8 mm

Art. 756/14
 Ø 75 mm
 Filetto/Thread hole M5
 Spessore/Thickness
 9 mm



Art. 756/2
 Ø 80 mm
 Filetto/Thread hole M5

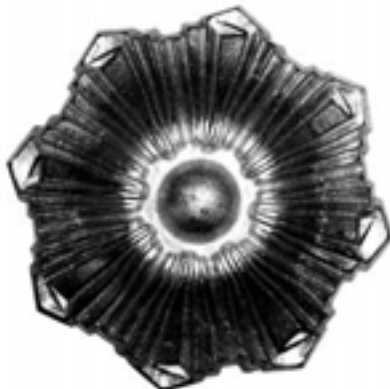

Art. 757/5
 25 mm - Ø 105 mm
 Filetto/Thread hole M4
 Spessore/Thickness 10,5 mm



ARTEFERRO



Art. 665/1

Ø 130 mm

Spessore/Thickness 4 mm



Art. 665/2

Ø 140 mm

Spessore/Thickness 4 mm



Art. 665/5

Ø 80 mm

Spessore/Thickness 2 mm



Art. 665/4

Ø 90 mm

Spessore/Thickness 2 mm



Art. 665/3

Ø 90 mm

Spessore/Thickness 2 mm



Art. 94/B/5

Ø 105 mm

Spessore/Thickness 4 mm



Art. 94/B/6

Ø 115 mm

Spessore/Thickness 4 mm



Art. 660/10

Ø 115 mm

Spessore/Thickness 4 mm



Art. 676/1

Ø 105 mm

Spessore/Thickness 4 mm



Art. 660/11

Ø 90 mm

Spessore/Thickness 4 mm

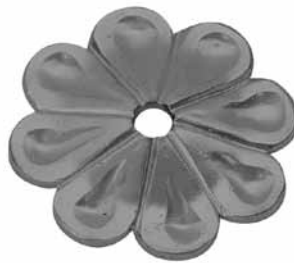

Art. 660/12

Ø 90 mm

Spessore/Thickness 4 mm



Art. GD239/4

Ø 68 mm

Foro/Hole Ø 8,5 mm
Spessore/Thickness 3 mm



ARTEFERRO

Art. GD239/5

Ø 90 mm

Foro/Hole Ø 12 mm
Spessore/Thickness 3 mm



Art. 717/5
H 285 x L 50 mm
Spessore/Thickness
1,5 mm



Art. 94/B/2
H 200 x L 70 mm
Spessore/Thickness
4 mm



Art. 664/7
H 285 x L 50 mm
Spessore/Thickness
3 mm

Ferro fuso
Cast steel



Art. 708/1
H 194 x L 67 mm
Spessore/Thickness
0,3 mm



Art. 708/3
H 120 x L 38 mm
Spessore/Thickness
0,3 mm



Art. 708/5
H 140 x L 51 mm
Spessore/Thickness
0,3 mm



Art. 708/9
H 148 x L 27 mm
Spessore/Thickness
0,3 mm



Art. 708/7
H 285 x L 55 mm
Spessore/Thickness
0,3 mm



Art. 139/1
H 65 x L 29 mm
Spessore/Thickness
0,5 mm



Art. 139/2
H 90 x L 41 mm
Spessore/Thickness
0,5 mm



Art. 139/3
H 85 x L 30 mm
Spessore/Thickness
0,5 mm



Art. 139/4
H 195 x L 70 mm
Spessore/Thickness
0,5 mm



Art. 139/5
H 100 x L 35 mm
Spessore/Thickness
0,5 mm



Art. 136/5

30 mm - Ø 65 mm
Spessore/Thickness
0,3 mm

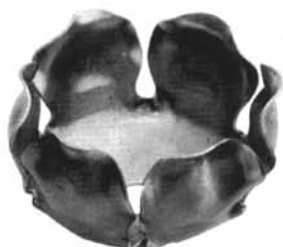

Art. 136/6

33 mm - Ø 55 mm
Spessore/Thickness
0,3 mm



Art. 136/7

40 mm - Ø 38 mm
Spessore/Thickness
0,3 mm



Art. 701/6

40 mm - Ø 65 mm
Spessore/Thickness
0,4 mm



Art. 140/8

10 mm - Ø 39 mm
Spessore/Thickness
0,5 mm



Art. 140/7

13 mm - Ø 24 mm
Spessore/Thickness
0,5 mm



Art. 140/6

15 mm - Ø 18 mm
Spessore/Thickness
0,5 mm



Art. 701/4

18 mm - Ø 39 mm
Spessore/Thickness
0,4 mm



Art. 136/8

18 mm - Ø 42 mm
Spessore/Thickness
0,3 mm

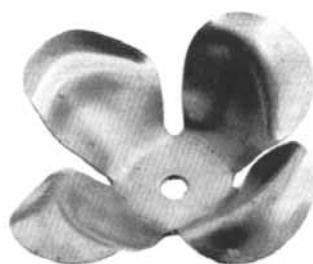

Art. 136/9

15 mm - Ø 48 mm
Spessore/Thickness
0,3 mm



Art. 140/5

69 mm - Ø 60 mm
Spessore/Thickness
0,5 mm



Art. 137/9

65 x 110 mm
Spessore/Thickness
0,5 mm



Art. 137/10

175 x 125 mm
Spessore/Thickness
0,5 mm



ARTEFERRO



Art. 666/2
L 90 x L 55 mm
Spessore/Thickness
4 mm



Art. 666/1
L 97 x L 55 mm
Spessore/Thickness
4 mm



Art. 666/3
90 mm - Ø 80 mm
Foro / Hole Ø 10 mm
Spessore/Thickness
4 mm



Art. 750/2
Ø 30 mm - 125 mm



ARTEFERRO



Art. 695/1
H 80 x L 80 mm
Spessore/Thickness
4 mm



Art. 695/2
H 85 x L 85 mm
Spessore/Thickness
4 mm

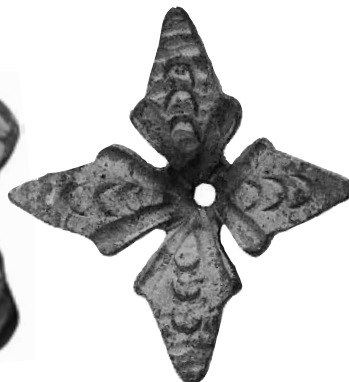

Art. 695/3
H 110 x 110 mm
Spessore/Thickness
4 mm



Art. 695/4
H 60 x L 60 mm
Spessore/Thickness
4 mm



Art. 695/5
H 60 x L 60 mm
Spessore/Thickness
4 mm



H 450 x L 450 mm
Art. 1330/1 - Verniciato/Painted
Art. 1330/3 - Non verniciato/Unpainted



H 450 x L 450 mm
Art. 1330/2 - Verniciato/Painted
Art. 1330/4 - Non verniciato/Unpainted



H 450 x L 450 mm
Art. 1331/1 - Verniciato/Painted
Art. 1331/3 - Non verniciato/Unpainted



H 450 x L 450 mm
Art. 1331/2 - Verniciato/Painted
Art. 1331/4 - Non verniciato/Unpainted



Art. 696/3
 H 430 x L 400 mm



Art. 720/3
 Ø 6 mm
 H 500 x L 270 mm



Art. 720/4
 Ø 6 mm
 H 640 x L 450 mm



Art. 1329/1
 Ø 8 mm
 H 450 x L 140 mm



Art. 1329/2
 Ø 8 mm
 H 450 x L 140 mm



Art. 1329/3
 Ø 8 mm
 H 450 x L 170 mm



Art. 1329/4
 Ø 8 mm
 H 450 x L 160 mm



Art. 1329/5
 Ø 6 mm
 H 300 x L 100 mm



Art. 689/5
 Ø 12 mm
 H 220 x L 120 mm
 Spessore/Thickness
 5 mm



Art. 689/6
 Ø 12 mm
 H 220 x L 120 mm
 Spessore/Thickness
 5 mm



Art. 689/3
 Ø 12 mm
 H 240 x L 120 mm
 Spessore/Thickness
 5 mm



Art. 689/1
 Ø 12 mm
 H 210 x L 120 mm
 Spessore/Thickness
 5 mm



Art. 689/2
 Ø 12 mm
 H 210 x L 120 mm
 Spessore/Thickness
 5 mm



Art. 689/4
 Ø 12 mm
 H 240 x L 120 mm
 Spessore/Thickness
 5 mm



Art. NEW0055
Base 32 mm
∅ 6 mm
H 110 x L 100 mm



Art. NEW0050
∅ 6 mm
H 220 x L 100 mm



Art. NEW0054
Base 35 mm
∅ 6 mm
H 140 x L 130 mm



Art. NEW0049
∅ 6 mm
H 280 x L 130 mm



Art. NEW0053
∅ 6 mm
H 185 x L 45 mm



Art. NEW0056
∅ 2,5 mm
H 90 x L 103 mm



NEW0057
∅ 2,5 mm
H 120 mm
L 92 mm



Art. I40/I/1
H 250 x L 195 mm
Spessore/Thickness
6 mm



Art. I40/I/4
H 100 x L 115 mm
Spessore/Thickness
6 mm



Art. 1857/4
L 60 mm
Spessore/Thickness
8 mm

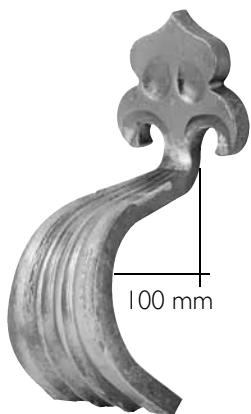

Art. 1857/3
L 80 mm
Spessore/Thickness
8 mm

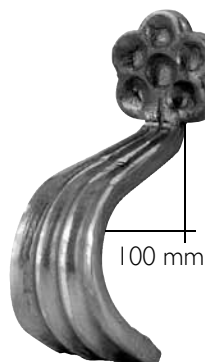

Art. 1857/2
L 45 mm
Spessore/Thickness
8 mm



Art. NEW0059
Base 20 mm
∅ 2,5 mm
H 118 x L 65 mm



ARTEFERRO



Ferro fuso/Cast steel
Art. 663/3
Ø 12 mm
H 90 x L 70 mm



Ferro fuso/Cast steel
Art. 663/4
Ø 12 mm
H 90 x L 70 mm



Ferro fuso/Cast steel
Art. 663/5
Ø 12 mm
H 180 x L 115 mm



Ferro fuso/Cast steel
Art. 663/6
Ø 12 mm
H 180 x L 115 mm



Art. 676/2
base Ø 8 mm
H 20 mm
Ø 50 mm



Art. 664/5
Ferro fuso/Cast steel
Ø 90 mm
foro/hole Ø 8 mm
Spess./Thick. 3 mm



Art. 665/6
Ø 80 mm
Spess./Thick. 2 mm



Ferro fuso/Cast steel
Art. 664/6
H 200 x L 60 mm



Ferro fuso/Cast steel
Art. 663/7
Ø 12 mm
H 190 x L 160 mm



Ferro fuso/Cast steel
Art. 663/8
Ø 12 mm
H 190 x L 160 mm



Ferro fuso/Cast steel
Art. 664/4
Ø 12 mm
H 90 x L 90 mm
Spess./Thick. 3 mm



Art. 751/1
H 185 x L 95 mm



Art. 94/B/1
H 140 x L 70 mm
Spess./Thick. 4 mm



Art. 94/B/3
H 200 x L 115 mm
Spess./Thick. 4 mm



Art. 750/1
Ø 14 mm
H 125 mm



Art. 751/5
H 165 x L 90 mm



Art. 140/B/3
H 165 x L 100 mm
Spess./Thick. 5 mm



Art. 750/3
Ø 35 mm
H 195 mm



Art. 94/B/4
H 250 x L 80 mm
Spess./Thick. 4 mm



Art. 1279/1

Φ 12 x 12 mm
H 280 x L 160 mm



Art. 1279/2

Φ 20 x 20 mm
H 340 x L 285 mm



Art. 1299/1

∇ 12 x 6 mm
140 x 60 mm

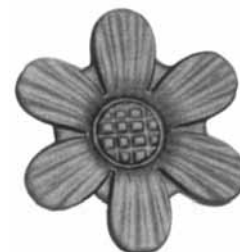

Art. 126/3

Ø 80 mm
Spess./Thickn. 4 mm



Art. 710/1

46 mm - Ø 122 mm
Spess./Thickn. 0,3 mm



Art. 697/1

Ø 90 mm
Spess./Thickn. 3 mm



Art. 1393/4

Ø 125 mm
Spess./Thickn. 8 mm



H 300 mm

Art. 751/2

∇ 12 x 6 mm

Art. 751/3

Φ 12 x 12 mm



Art. 710/7

45 mm - Ø 90 mm
Spess./Thickn. 0,3 mm

Art. 697/2

Ø 60 mm
Spess./Thickn. 3 mm

Art. 1393/5

Ø 90 mm
Spess./Thickn. 8 mm



Art. 711/7

25 mm - Ø 140 mm
Spess./Thickn. 1 mm



Art. 711/8

19 mm - Ø 97 mm
Spess./Thickn. 1 mm



Art. 701/3

25 mm - Ø 90 mm
Spess./Thickn. 0,3 mm

Art. 1393/6

Ø 55 mm
Spess./Thickn. 8 mm

Art. 711/9

26 mm - Ø 120 mm
Spess./Thickn. 1 mm



Art. 710/11

85 mm - Ø 100 mm
Spess./Thickn. 0,3 mm



Art. 710/9

40 mm - Ø 100 mm
Spess./Thickn. 0,3 mm



Art. 710/3

39 mm - Ø 100 mm
Spess./Thickn. 0,3 mm



Art. 710/13

28 mm - Ø 100 mm
Spess./Thickn. 0,3 mm



Art. 137/1
H 160 x L 80 mm
Spess./Thickn. 2 mm



Art. 137/2
H 160 x L 80 mm
Spess./Thickn. 2 mm



Art. 137/4
H 75 x L 50 mm
Spess./Thickn. 0,5 mm



Art. 137/11
H 85 x L 68 mm
Spess./Thickn. 2 mm



Art. 140/4
H 100 x L 35 mm
Spess./Thickn. 0,5 mm



Art. 140/B/1
H 175 x L 289 mm
Spess./Thickn. 5 mm



Art. 140/B/2
H 140 x L 165 mm
Spess./Thickn. 5 mm



Art. 1796/2
H 170 x L 140 mm
Spess./Thickn. 10 mm



Art. 140/F/4
H 160 x L 70 mm
Spess./Thickn. 5 mm



Art. 140/F/3
H 160 x L 70 mm
Spess./Thickn. 5 mm



Art. 140/E/3
H 265 x L 160 mm
Spess./Thickn. 5 mm



Art. 140/F/1
H 185 x L 100 mm
Spess./Thickn. 5 mm



Art. 140/F/2
H 185 x L 100 mm
Spess./Thickn. 5 mm



Art. 140/D/1
H 270 x L 190 mm
Spess./Thickn. 5 mm



Art. 140/E/1
H 265 x L 70 mm
Spess./Thickn. 5 mm



Art. 140/C/3
H 355 x L 280 mm
Spess./Thickn. 5 mm



Art. 140/C/4
H 185 x L 150 mm
Spess./Thickn. 5 mm



Art. 140/C/1
H 325 x L 400 mm
Spess./Thickn. 7 mm



Art. 140/C/2
H 325 x L 400 mm
Spess./Thickn. 7 mm



Art. 140/E/2
H 265 x L 70 mm
Spess./Thickn. 5 mm



Art. 140/D/2

H 155 x L 90 mm
Spess./Thickn. 5 mm



Art. 140/D/3

H 155 x L 90 mm
Spess./Thickn. 5 mm



Art. 704/1

H 136 x L 33 mm
Spess./Thickn. 0,3 mm



Art. 666/4

H 190 x L 45 mm
Spess./Thickn. 4 mm



Art. 666/5

H 190 x L 45 mm
Spess./Thickn. 4 mm



Art. 666/6

H 240 x L 77 mm
Spess./Thickn. 4 mm



Art. 704/5

H 90 x L 32 mm
Spess./Thickn. 0,3 mm



Art. 704/3

H 116 x L 34 mm
Spess./Thickn. 0,3 mm



Art. 666/7

H 360 x L 110 mm
Spess./Thickn. 4 mm



Art. 666/8

H 360 x L 110 mm
Spess./Thickn. 4 mm



Art. 666/9

H 390 x L 155 mm
Spess./Thickn. 4 mm



Art. 704/11

H 85 x L 31 mm
Spess./Thickn. 0,3 mm



Art. 692/1

H 270 x L 85 mm
Spess./Thickn. 4 mm



Art. 692/10

H 230 x L 110 mm
Spess./Thickn. 4 mm



Art. 704/7

H 85 x L 29 mm
Spess./Thickn. 0,3 mm



Art. 660/9

H 205 x L 95 mm
Spess./Thickn. 6 mm



Art. 138/7

H 30 x L 85 mm
Spess./Thickn. 0,3 mm



Art. 138/16

H 30 x L 85 mm
Spess./Thickn. 0,3 mm



Art. 704/9

H 90 x L 34 mm
Spess./Thickn. 0,3 mm



Art. 691/6

H 100 x L 80 mm
Ø 12 mm
Spess./Thickn. 5 mm



Art. 691/7

H 100 x L 80 mm
Ø 12 mm
Spess./Thickn. 5 mm



Art. 705/1

20 mm - Ø 46 mm
Filetto/Thread M3
Spess./Thickn. 0,3 mm



Art. 705/3

45 mm - Ø 55 mm
Filetto/Thread M3
Spess./Thickn. 0,3 mm



Art. 705/5

36 mm - Ø 40 mm
Filetto/Thread M3
Spess./Thickn. 0,3 mm

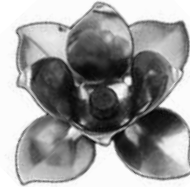

Art. 705/7

16 mm - Ø 45 mm
Filetto/Thread M3
Spess./Thickn. 0,3 mm



Art. 705/9

15 mm - Ø 43 mm
Filetto/Thread M3
Spess./Thickn. 0,3 mm



Art. 1406/2

20 mm - Ø 120 mm



Art. 1406/3

40 mm - Ø 140 mm



Art. 1406/10

25 mm - Ø 130 mm



Art. 1406/11

25 mm - Ø 150 mm



Art. 1406/6

25 mm - Ø 90 mm



Art. 1406/9

20 mm - Ø 100 mm



Art. 1406/8

25 mm - Ø 60 mm



Art. 1406/7

25 mm - Ø 90 mm



Art. 1406/5

20 mm - Ø 90 mm

FIORI E ORNAMENTI - FLOWERS AND ORNAMENTS



ARTEFERRO



Art. 701/8
50 mm - Ø 90 mm
Spess./Thickn. 0,4 mm



Art. 701/9
25 mm - Ø 110 mm
Spess./Thickn. 0,4 mm



Art. 701/7
50 mm - Ø 55 mm
Spess./Thickn. 0,4 mm



Art. 701/5
50 mm - Ø 110 mm
Spess./Thickn. 0,4 mm



Art. 705/15
50 mm - Ø 70 mm
Spess./Thickn. 0,3 mm



Art. 705/17
42 mm - Ø 46 mm
Spess./Thickn. 0,3 mm



Art. 705/13
10 mm - Ø 45 mm
Filetto/Thread M3
Spess./Thickn. 0,3 mm



Art. 705/11
12 mm - Ø 45 mm
Filetto/Thread M3
Spess./Thickn. 0,3 mm



Art. 676/3
H 20 mm - Ø 70 mm
Base Ø 8 mm



Art. 711/4
45 mm - Ø 120 mm
Spess./Thickn. 0,3 mm



Art. 711/5
17 mm - Ø 107 mm
Spess./Thick. 0,5 mm



Art. 711/6
28 mm - Ø 150 mm
Spess./Thickn. 0,3 mm



Art. 1328/6
30 mm - Ø 180 mm
Spess./Thickn. 4 mm

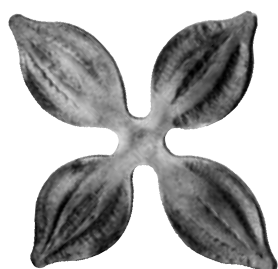

Art. 140/D/4
H 285 x L 285 mm
Spess./Thickn. 5 mm



Art. 1406/1
20 mm - Ø 80 mm



Art. 1406/4
40 mm - Ø 190 mm



Art. 696/2
Ø 440 mm





Art. 494/3
H 140 x L 230 mm
Φ foro/hole 14 mm



Art. 675/5
H 135 x L 85 mm
Spess./Thickn. 4 mm



Art. 620/2
Φ 12 x 12 mm
H 200 mm



Art. 620/4
Φ 12 x 12 mm
H 200 mm



Art. 620/3
Φ 12 x 12 mm
H 200 mm



Art. 694/10
H 80 x L 20 mm
Spess./Thickn. 4 mm



Art. 660/3
H 210 x L 130 mm
Spess./Thickn. 6 mm



Art. 660/4
H 210 x L 130 mm
Spess./Thickn. 6 mm



Art. 660/5
H 200 x L 140 mm
Spess./Thickn. 6 mm



Art. 660/6
H 200 x L 140 mm
Spess./Thickn. 6 mm



Art. 691/4
Ø 12 mm
H 120 x L 70 mm
Spess./Thickn. 5 mm



Art. 660/7
H 215 x L 145 mm
Spess./Thickn. 6 mm



Art. 660/8
H 215 x L 145 mm
Spess./Thickn. 6 mm



Art. 675/17
H 210 x L 120 mm
Spess./Thickn. 6 mm



Art. 675/16
H 210 x L 120 mm
Spess./Thickn. 6 mm



Art. 691/3
Ø 12 mm
H 70 x L 120 mm
Spess./Thickn. 5 mm



Art. 690/3
Ø 12 mm
H 112 x L 70 mm
Spess./Thickn. 5 mm



Art. 690/4
Ø 12 mm
H 112 x L 70 mm
Spess./Thickn. 5 mm

Art. 139/6
H 70 x L 28 mm
Spess./Thickn. 0,5 mm



Art. 660/1
H 410 x L 185 mm
Spess./Thickn. 6 mm



Art. 660/2
H 410 x L 185 mm
Spess./Thickn. 6 mm

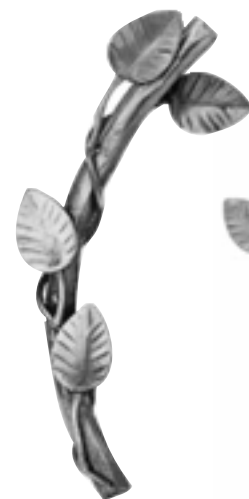

Art. 604/4
Ø 16 mm
H 250 mm



Art. 604/9
Ø 12 mm
H 250 mm



Art. 690/2
H 160 x L 80 mm
Ø 12 mm
Spess./Thickn. 5 mm



Art. 690/1
H 160 x L 80 mm
Ø 12 mm
Spess./Thickn. 5 mm

Art. 604/5
Ø 16 mm
H 370 mm
Art. 604/10
Ø 12 mm
H 370 mm



Art. 1328/5
Ø 8 mm
H 400 mm



Art. 1328/4
Gambo/Stam Ø 6 mm
H 300 - 25 mm



Art. 694/7
Ø 10 mm
H 280 x L 70 mm



Art. 694/8
Ø 10 mm
H 280 x L 70 mm



Art. 694/1
16 x 8 mm
H 280 x L 70 mm



Art. 694/2
16 x 8 mm
H 280 x L 70 mm



Art. 694/5
Ø 10 mm
H 200 x L 100 mm



Art. 694/6
Ø 10 mm
H 200 x L 100 mm



Art. 694/3
16 x 8 mm
H 200 x L 100 mm



Art. 694/4
16 x 8 mm
H 200 x L 100 mm



Art. 694/11
H 190 x L 95 mm
Spess./Thickn. 6 mm



Art. 675/7
H 240 x L 70 mm
Spess./Thickn. 8 mm



Art. 675/6
H 240 x L 70 mm
Spess./Thickn. 8 mm



Art. 694/12
H 210 x L 120 mm
Spess./Thickn. 6 mm



Art. 694/13
H 210 x L 120 mm
Spess./Thickn. 6 mm



Ferro fusol/Cast steel
Art. 664/9
Ø 12 mm
H 285 x L 80 mm



Art. 692/2
H 80 x L 80 mm



Art. 692/3
H 95 x L 60 mm
Spess./Thickn. 4 mm



Art. 675/8
H 85 x L 60 mm
Spess./Thickn. 3 mm



Art. 675/9
H 85 x L 60 mm
Spess./Thickn. 3 mm



Ferro fuso/Cast steel
Art. 664/3
H 40 - Ø 40 mm
Spess./Thickn. 3 mm



Art. 692/4
H 170 x L 95 mm
Spess./Thickn. 5 mm



Art. 692/5
H 150 x L 95 mm
Spess./Thickn. 5 mm



Art. 692/6
H 160 x L 80 mm
Spess./Thickn. 5 mm



Art. 692/7
H 120 x L 95 mm
Spess./Thickn. 5 mm



Art. 1328/1
Gambo/Stam
Ø 8 mm
H 400 - Ø 120 mm



Art. 675/10
H 110 x L 85 mm
Spess./Thickn. 3 mm



Art. 675/11
H 110 x L 85 mm
Spess./Thickn. 3 mm



Art. 675/12
H 110 x L 80 mm
Spess./Thickn. 3 mm



Art. 675/13
H 110 x L 80 mm
Spess./Thickn. 3 mm



Art. 675/14
H 85 x L 60 mm
Spess./Thickn. 3 mm



Art. 675/15
H 85 x L 60 mm
Spess./Thickn. 3 mm



Art. 1857/11
H 245 x L 90 mm



Art. 1857/12
H 245 x L 90 mm



Art. 1328/2
Gambo/Stam
Ø 6 mm
H 300 - Ø 80 mm



Art. 40/B/12
Ø 48 mm
Spess./Thickn. 2 mm



Art. 1857/9
H 190 x L 90 mm



Art. 1857/10
H 190 x L 90 mm



Art. 40/B/11
Ø 35 mm
Spess./Thickn. 0,5 mm



Ferro fuso/Cast steel
Art. 664/8
H 250 x L 130 mm
Spess./Thickn. 3 mm



Ghisa - 2 fori filetto
Two Threaded holes M5
Art. 756/10
H 195 x L 470 mm
Spess./Thickn. 20 mm



Art. 694/9
H 100 x L 20 mm
Spess./Thickn. 4 mm



Art. 706/7
H 50 x L 22 mm
Spess./Thickn. 0,3 mm



Art. 706/9
H 65 x L 28 mm
Spess./Thickn. 0,3 mm



Art. 1857/1
H 145 x L 160 mm



Art. 707/5
H 140 x L 120 mm
Spess./Thickn. 0,3 mm



Art. 706/13
H 110 x L 48 mm
Spess./Thickn. 0,3 mm



Art. 706/17
H 73 x L 22 mm
Spess./Thickn. 0,3 mm



Art. 706/11
H 80 x L 34 mm
Spess./Thickn. 0,3 mm



Ghisa/Cast iron
Due mezzi gusci
Two half shells iron
Art. 34/2
Ø 75 mm

Art. 707/3
H 94 x L 80 mm
Spess./Thickn. 0,3 mm



Art. 708/11
H 152 x L 105 mm
Spess./Thickn. 0,3 mm



Art. 708/13
H 152 x L 105 mm
Spess./Thickn. 0,3 mm



Art. 709/21
H 199 x L 19 mm
Spess./Thickn. 0,3 mm



Art. 709/3
H 36 x L 30 mm
Spess./Thickn. 0,3 mm



Art. 709/5
H 48 x L 39 mm
Spess./Thickn. 0,3 mm



Art. 709/1
H 60 x L 49 mm
Spess./Thickn. 0,3 mm



Art. 709/17
H 175 x L 41 mm
Spess./Thickn. 0,3 mm



Art. 701/2
Ø 60 mm
Spess./Thickn. 0,4 mm



Art. 707/9
Ø 35 mm
Spess./Thickn. 0,3 mm



Art. 707/11
H 56 x L 34 mm
Spess./Thickn. 0,3 mm



Art. 707/13
H 56 x L 34 mm
Spess./Thickn. 0,3 mm



Art. 709/13
H 68 x L 18 mm
Spess./Thickn. 0,3 mm

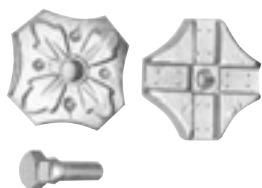

Brevettato/Patent pending
Art. 698/1
Ø 65 mm

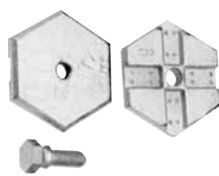

Brevettato/Patent pending
Art. 698/2
Ø 70 mm



Art. 708/15
H 110 x L 35 mm
Spess./Thickn. 0,3 mm



Art. 708/17
H 110 x L 35 mm
Spess./Thickn. 0,3 mm



Art. 709/15
H 128 x L 31 mm
Spess./Thickn. 0,3 mm

Ghisa - Cast iron



Art. 757/4
H 80 x L 145 mm
filetto/Threaded hole M4
Spess./Thickn. 15 mm



Art. 756/15
H 180 x L 347 mm
2 filetto/Threaded hole M5
Spess./Thickn. 28 mm



Art. 756/16
H 100 x L 220 mm
filetto/Threaded hole M5
Spess./Thickn. 15 mm



Art. 756/17
H 100 x L 220 mm
filetto/Threaded hole M5
Spess./Thickn. 15 mm



Art. 756/8
H 210 x L 330 mm
2 filetto/Threaded hole M5
Spess./Thickn. 28 mm



Art. 756/6
245 x 285 mm
4 foro filetto/Threaded hole M5
Spess./Thick. 7 mm



Art. 756/9
H 210 x L 330 mm
2 filetto/Threaded hole M5
Spess./Thickn. 28 mm



Art. 1328/7
H 150 x L 45 mm
Spess./Thickn. 4 mm



Art. 1328/8
H 190 x L 100 mm
Spess./Thickn. 4 mm



Art. 1328/9
H 180 x L 170 mm
Spess./Thickn. 4 mm



Art. 1393/3
Ø 75 mm



Art. 707/7
H 50 x L 100 mm
Spess./Thickn. 0,3 mm



Art. 1699/10
95 x 60 mm
Spess./Thickn. 3 mm



Art. 1699/11
95 x 60 mm
Spess./Thickn. 3 mm



Art. 1796/1
100 x 40 mm
Ø 12 x 6 mm



Art. 1411/10
H 100 x 65 mm
Spess./Thickn. 5 mm



Art. 1411/11
H 100 x 65 mm
Spess./Thickn. 5 mm



Art. 1411/12
H 63 x 28 mm
Spess./Thickn. 5 mm



ARTEFERRO



Orchidea in vetro di Murano
Orchids in Murano glass
Bussola in ottone/Brass boss
Art. 1330/5
100 mm - Ø 60 mm
Filetto/Thread 4 MA



Orchidea in vetro di Murano
Orchids in Murano glass
Bussola in ottone/Brass boss
Art. 1330/6
100 mm - Ø 60 mm
Filetto/Thread 4 MA



Orchidea in vetro di Murano
Orchids in Murano glass
Bussola in ottone/Brass boss
Art. 1330/7
100 mm - Ø 60 mm
Filetto/Thread 4 MA



Orchidea in vetro di Murano
Orchids in Murano glass
Bussola in ottone/Brass boss
Art. 1330/8
100 mm - Ø 60 mm
Filetto/Thread 4 MA



Orchidea in vetro di Murano
Orchids in Murano glass
Bussola in ottone/Brass boss
Art. 1330/9
100 mm - Ø 60 mm
Filetto/Thread 4 MA



Orchidea in vetro di Murano
Orchids in Murano glass
Bussola in ottone/Brass boss
Art. 1330/10
100 mm - Ø 60 mm
Filetto/Thread 4 MA



Margherita in vetro di Murano
rosa satinato
Daisy in Murano pink satin glass
Art. 1330/11
20 mm - Ø 80 mm
Foro/Hole Ø 6 mm



Margherita in vetro di Murano
color rubino
Daisy in Murano pink satin glass
Art. 1330/12
20 mm - Ø 80 mm
Foro/Hole Ø 6 mm



Foglia verde in vetro di Murano
Leaf in mMurano green glass
Bussola in ottone/Brass boss
Art. 1330/13
H 85 x 35 mm
Filetto/Thread 4 MA



Foglia verde in vetro di Murano
Leaf in mMurano green glass
Bussola in ottone/Brass boss
Art. 1330/14
H 65 x 30 mm
Filetto/Thread 4 MA

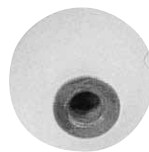

Sfera in vetro satinato
Sphere in satin glass
Art. 1331/5
Ø 15 mm
Filetto/Thread 4 MA

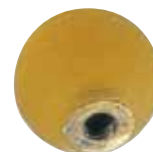

Sfera in vetro satinato
Sphere in satin glass
Art. 1331/6
Ø 15 mm
Filetto/Thread 4 MA

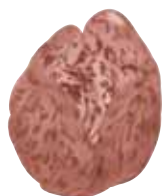

Bocciolo in vetro rosso satinato
Buds in red satin glass
Art. 1331/9
55 mm - Ø 35 mm



Bocciolo in vetro giallo satinato
Buds in yellow satin glass
Art. 1331/10
55 mm - Ø 35 mm



Bocciolo in vetro bianco lucido
Buds in white shiny glass
Art. 1331/7
75 mm - Ø 40 mm
Filetto/Thread 4 MA



Bocciolo in vetro giallo satinato
Buds in white shiny glass
Art. 1331/8
75 mm - Ø 40 mm
Filetto/Thread 4 MA



Art. 199/1
25 x 25 mm
Spess./Thickn. 3 mm



Art. 199/7
70 x 30 mm
Spess./Thickn. 3 mm



Art. 199/2
120 x 120 mm
Spess./Thickn. 3 mm



Art. 199/9
fascetta per/collar for
Art. 199/3 + 199/4
Art. 199/10
fascetta per/collar for
Art. 199/16 + 199/17
Art. 199/12
fascetta per/collar for
Art. 199/13 + 199/14



Art. 199/3
160 x 60 mm
Spess./Thickn. 3 mm



Art. 199/4
160 x 60 mm
Spess./Thickn. 3 mm



Art. 199/5
160 x 120 mm
Spess./Thickn. 3 mm



Art. 199/6
230 x 150 mm
Spess./Thickn. 3 mm



Art. 199/15
105 x 80 mm
Spess./Thickn. 3 mm



Art. 199/8
40 x 80 mm
Spess./Thickn. 3 mm



Art. 199/11
25 x 45 mm
Spess./Thickn. 3 mm



Art. 199/13
105 x 40 mm
Spess./Thickn. 3 mm



Art. 199/14
105 x 40 mm
Spess./Thickn. 3 mm



Art. 199/16
230 x 75 mm
Spess./Thickn. 3 mm



Art. 199/17
230 x 75 mm
Spess./Thickn. 3 mm



ARTEFERRO



ELEMENTI VARI - VARIOUS ELEMENTS

COMPENDIUM 2010

Art. 181/10
285 x 105 mm
spessore/thickness 30 mm

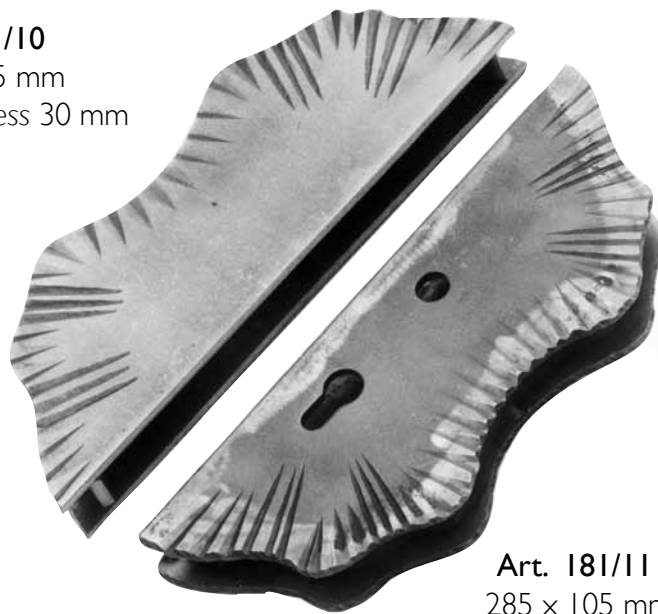

Art. 181/12

Art. 181/11
285 x 105 mm
spessore / thickness 30 mm



Art. 181/15



Art. 169/11
70 x 125 mm
(coppia - couple)

maniglia completa di rosetta
Door handle complete with rosette





Art. 841/5
210 x 290 mm
spessore/thickness 4 mm

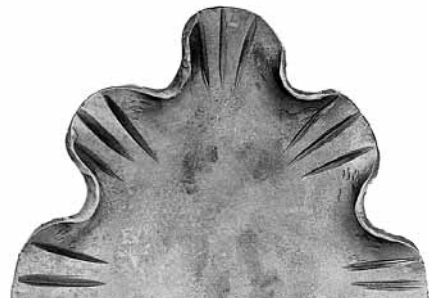

Art. 841/6
200 x 150 mm
spessore/thickness 4 mm



Art. 841/1 275 x 160 mm
sp./thickness 3 mm

Art. 841/2 275 x 160 mm
sp./thickness 3 mm



Art. 841/3 275 x 160 mm
sp./thickness 3 mm

Art. 841/4 275 x 160 mm
sp./thickness 3 mm



Art. 842/1 275 x 190 mm
sp./thickness 3 mm

Art. 842/2 275 x 190 mm
sp./thickness 3 mm



Art. 842/3 275 x 190 mm
sp./thickness 3 mm

Art. 842/4 275 x 190 mm
sp./thickness 3 mm



Art. 842/5 290 x 175 mm
sp./thickness 3 mm

Art. 842/6 290 x 175 mm
sp./thickness 3 mm



Art. 842/7 290 x 175 mm
sp./thickness 3 mm

Art. 842/8 290 x 175 mm
sp./thickness 3 mm



Art. 169/12
70 x 135 mm
(coppia - couple)



Art. 169/15
40 x 110 mm
(coppia - couple)

maniglia completa di rosetta
Door handle complete with rosette



Art. 169/14
70 x 135 mm
(coppia - couple)

maniglia completa di rosetta
Door handle complete with rosette



Art. 835/6
Rosetta/Rosette Ø 30 mm



Art. 169/13
80 x 140 mm
(coppia - couple)



Art. 168/5
265 x 48 mm
(coppia - couple)



Art. 168/4
250 x 38 mm
(coppia - couple)



Art. 168/6
250 x 56 mm
(coppia - couple)



Art. 168/3
265 x 48 mm
(coppia - couple)



Art. 833/4
280 x 60 mm
(coppia - couple)



Art. 836/1
250 x 50 mm
(coppia - couple)

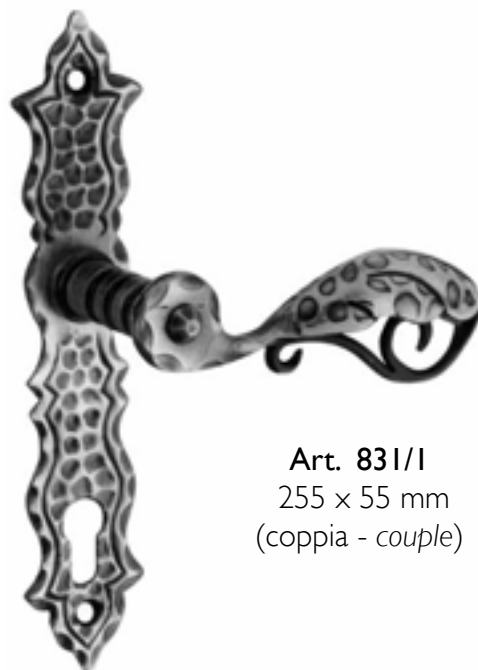

Art. 831/1
255 x 55 mm
(coppia - couple)



ARTEFERRO



Art. 835/8
90 x 50 mm



Art. 835/7
90 x 50 mm



Art. 835/9
100 x 40 mm



c = 82 mm - d = 153 mm
e = 135 mm - f = 50 mm
g = 235 mm - m = 605 mm
(coppia - couple)

Art. 1476/A/1
con foro
with key hole

Art. 1476/A/9
senza foro
without key hole

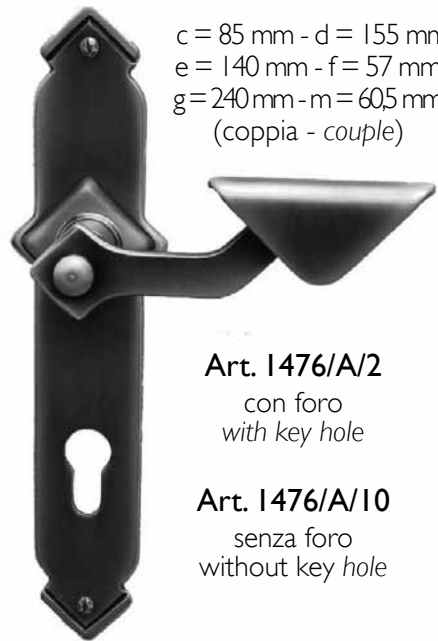

c = 85 mm - d = 155 mm
e = 140 mm - f = 57 mm
g = 240 mm - m = 605 mm
(coppia - couple)

Art. 1476/A/2
con foro
with key hole

Art. 1476/A/10
senza foro
without key hole

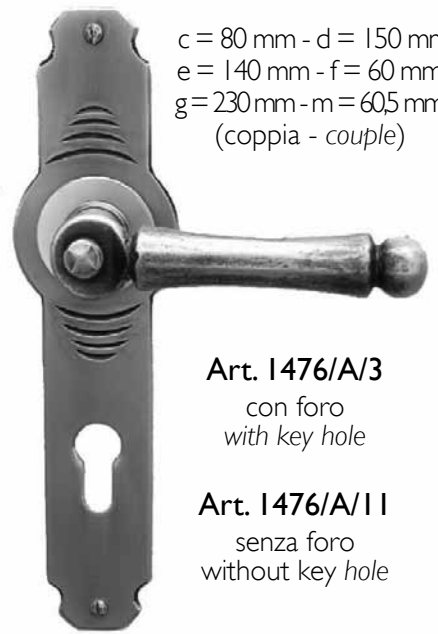

c = 80 mm - d = 150 mm
e = 140 mm - f = 60 mm
g = 230 mm - m = 605 mm
(coppia - couple)

Art. 1476/A/3
con foro
with key hole

Art. 1476/A/11
senza foro
without key hole



c = 95 mm - d = 165 mm
e = 133,5 mm - f = 53 mm
g = 260 mm - m = 605 mm
(coppia - couple)

Art. 1476/A/4
con foro
with key hole

Art. 1476/A/12
senza foro
without key hole



c = 85 mm - d = 155 mm
e = 142 mm - f = 45 mm
g = 240 mm - m = 605 mm
(coppia - couple)

Art. 1476/A/5
con foro
with key hole

Art. 1476/A/13
senza foro
without key hole



c = 80 mm - d = 150 mm
e = 142 mm - f = 50 mm
g = 230 mm - m = 605 mm
(coppia - couple)

Art. 1476/A/6
con foro
with key hole

Art. 1476/A/14
senza foro
without key hole

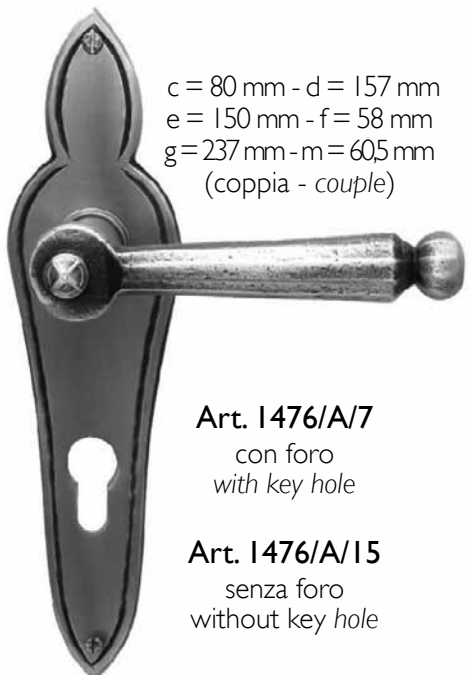

c = 80 mm - d = 157 mm
e = 150 mm - f = 58 mm
g = 237 mm - m = 605 mm
(coppia - couple)

Art. 1476/A/7
con foro
with key hole

Art. 1476/A/15
senza foro
without key hole

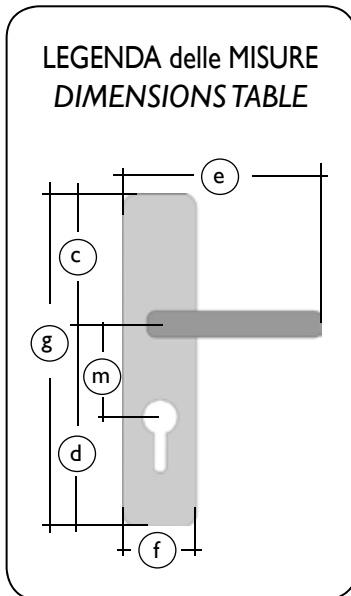

c = 125 mm - d = 180 mm
e = 160 mm - f = 55 mm
g = 305 mm - m = 605 mm
(coppia - couple)

Art. 1476/A/8
con foro
with key hole



Art. 1476/1
 $a = 129 - b = 100$ mm
 (coppia - couple)

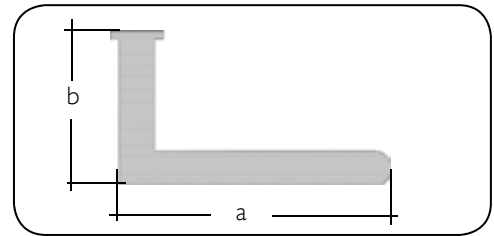

Art. 1476/2
 $a = 130 - b = 72$ mm
 (coppia - couple)



Art. 1476/3
 $a = 124 - b = 69$ mm
 (coppia - couple)



Art. 1476/4
 $a = 130 - b = 79$ mm
 (coppia - couple)



Art. 1476/5
 $a = 135 - b = 78$ mm
 (coppia - couple)



Art. 1476/6
 $a = 114 - b = 95$ mm
 (coppia - couple)



Art. 1476/7
 $a = 133 - b = 75$ mm
 (coppia - couple)



Art. 1476/8
 $a = 149 - b = 100$ mm
 (coppia - couple)

PLACCHE per IMPUGNATURA
 ROSETTES for HANDLES

Art. 1476/9
 $\varnothing 52,5$ mm
 sp./thick. 3 mm



Art. 1476/10
 $\varnothing 53,5$
 $h 63,2$ mm
 sp./thick. 3 mm



PLACCHE per SERRATURA
 ROSETTES for LOCKS

Art. 1476/11
 $\varnothing 52,5$ mm
 sp./thick. 3 mm



Art. 1476/12
 $\varnothing 52,5$ mm
 sp./thick. 3 mm



Art. 1476/13
 $\varnothing 53,5$ mm
 $h 63,2$ mm
 sp./thick. 3 mm



Art. 1476/14
 $\varnothing 53,5$ mm
 $h 63,2$ mm
 sp./thick. 3 mm



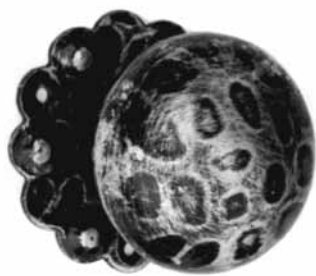

Art. 169/1
 Ø 68 mm
 girevole - rotating

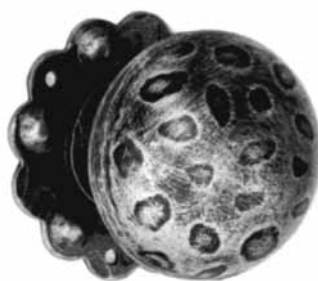

Art. 169/2
 Ø 60 mm
 girevole - rotating



Art. 169/3
 Ø 60 mm
 girevole - rotating

Ø = diameter



Art. 834/1
 Ø 67 mm
 H 75 mm
 girevole - rotating



Art. 834/2
 Ø 67 mm



Art. 838/1
 57 x 57 mm
 H 70 mm
 girevole - rotating



Art. 838/2
 57 x 57 mm
 H 70 mm
 fisso - fixed

Art. 838/3
 60 x 60 mm
 H 45 mm
 fisso - fixed



Art. 838/4
 75 x 75 mm
 H 60 mm
 fisso - fixed



Art. 170/1
Ø 65 mm



Art. 170/2
Ø 65 mm



Art. 170/3
Ø 50 mm



Art. 170/5
Ø 50 mm



Art. 839/5
85 x 35 mm
sp./thick. 2 mm



Art. 839/6
85 x 35 mm
sp./thick. 2 mm



Art. 839/7
85 x 35 mm
sp./thick. 2 mm
foro/hole Ø 14 mm



Art. 839/8
70 x 35 mm
sp./thick. 2 mm



Art. 839/9
100 x 40 mm
sp./thick. 2 mm



Art. 839/10
100 x 40 mm
sp./thick. 2 mm
foro/hole Ø 14 mm

Ø = diameter



Art. 169/6
250 x 56 mm



Art. 169/7
250 x 38 mm



Art. 169/8
265 x 48 mm



Art. 169/9
265 x 48 mm

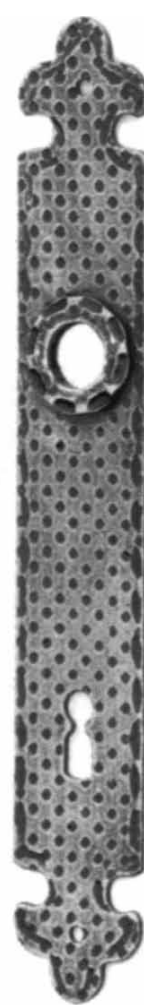

Art. 169/10
250 x 38 mm



Art. 832/5
255 x 50 mm



Art. 832/1
265 x 60 mm



Art. 832/2
220 x 45 mm



Art. 832/3
295 x 60 mm



Art. 832/4
280 x 60 mm
fisso / fixed



Art. 832/6
265 x 75 mm



Art. 832/7
265 x 60 mm



Art. 832/8
255 x 65 mm



Art. 833/7
240 x 50 mm



Art. 833/5
255 x 50 mm



Art. 833/8
250 x 53 mm



Art. 833/9
265 x 50 mm



Art. 836/2
275 x 60 mm



Art. 836/3
255 x 65 mm



Art. 836/5
225 x 60 mm



Art. 836/6
270 x 40 mm



Art. 836/7
280 x 40 mm



Art. 836/8
255 x 50 mm



Art. 836/9
255 x 50 mm



Art. 1475/1
250 x 40 mm



Art. 1475/5
265 x 47 mm

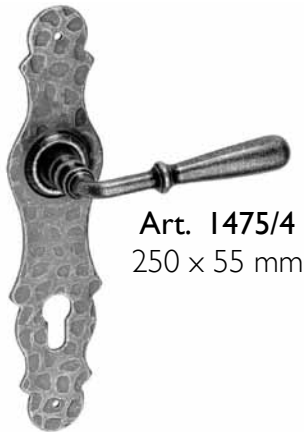

Art. 1475/4
250 x 55 mm

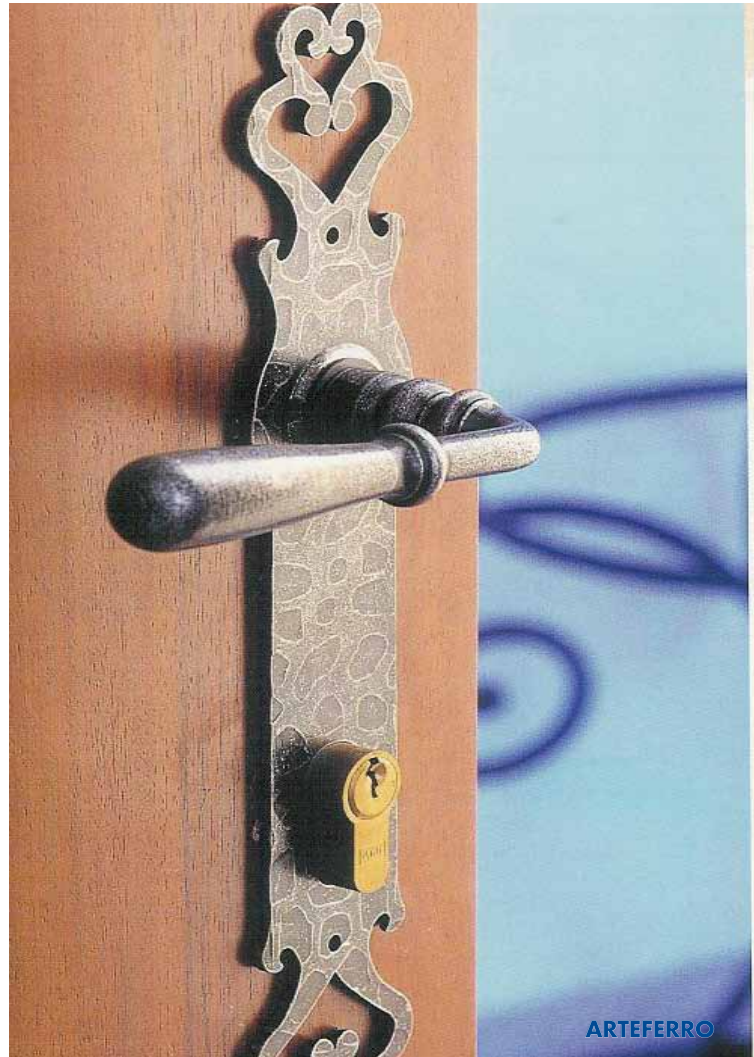

Art. 1475/6
220 x 50 mm



Art. 168/2
250 x 56 mm



Art. 1475/2
270 x 55 mm



Art. 1475/3
250 x 40 mm



Art. 833/6
240 x 260 mm



Art. 834/3
265 x 80 mm



Art. 836/4
275 x 60 mm
girevole / rotating

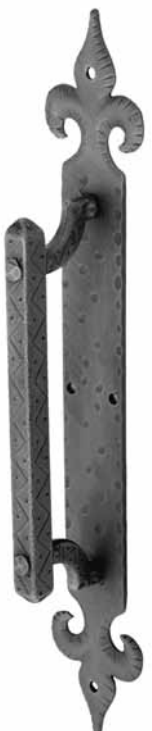

Art. 839/4
250 x 70 mm
□ 18 mm



Art. 170/6
310 x 60 mm

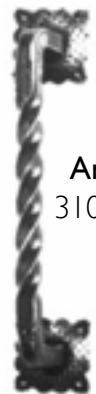

Art. 839/1
H 300 mm
Ø 32 mm
Rosetta/Rosette
Ø 80 mm



Art. 839/2
H 200 mm
Ø 25 mm
Rosetta/Rosette
Ø 60 mm



Art. 1474/3
315 x 40 mm



Art. 1474/5
Ø 70 mm
Ø 8MA foro filetto
dia 8MA threaded hole

Ø = diameter

Art. 839/3
480 x 80 mm
□ 18 mm



ARTEFERRO

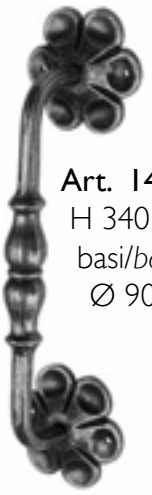

Art. 1474/2
H 340 mm
basi/bases
Ø 90 mm



Art. 1474/1
270 x 55 mm



Art. 833/3
77 x 35 mm



Art. 833/2
Ø 53 mm



Art. 833/1
58 x 58 mm



Art. 1475/7
37 x 75 mm



Art. 835/1
200 x 40 mm



Art. 835/2
160 x 55 mm



Art. 835/3
150 x 45 mm



Art. 835/4
140 x 33 mm



Art. 835/5
190 x 35 mm



Art. 170/7
170 x 105 mm



Art. 837/2
Ø 150 mm
rosetta/rosette
Ø 80 mm



Art. 1474/4
Ø 120 mm
base Ø 90 mm



Art. 837/1
Ø 110 mm
rosetta/rosette
Ø 95 mm



Art. 170/A/6
90 x 33 mm



Art. 170/A/4
90 x 38 mm



Art. 170/A/5
49 x 43 mm



Art. 170/A/10
49 x 43 mm



Art. 837/3
Ø 100 mm
rosetta/rosette
Ø 60 mm



Art. 170/A/8
58 x 27 mm



Art. 170/A/11
58 x 27 mm



Art. 170/A/2
68 x 125 mm



Art. 170/A/7
48 x 48 mm



Art. 170/A/9
48 x 48 mm



Art. 170/A/1
31 x 121 mm



Art. 170/A/3
92 x 55 mm



Art. 837/4
H 145 mm
60 x 2 mm



Art. 837/9
H 145 mm
110 x 2 mm



Art. 837/7
H 95 mm
70 x 2 mm



Art. 170/B/1
45 x 190 mm



Art. 170/B/2
30 x 150 mm



Art. 170/B/3
30 x 105 mm



Art. 170/B/5
81 x 137 mm



Art. 837/5
H 260 mm
55 x 2 mm



Art. 837/10
H 160 mm
120 x 2 mm



Art. 837/8
H 100 mm
70 x 2 mm



Art. 840/4
30 x 160 mm



Art. 840/5
30 x 200 mm



Art. 840/6
50 x 150 mm



Art. 837/6
165 x 70 mm
Ø 15 mm



Art. 169/4
H 250 mm
L 40 mm



Art. 169/5



Art. 840/1
65 x 300 mm



Art. 840/2
65 x 350 mm



Art. 840/3
65 x 400 mm

Ø = diameter





Art. 170/B/4
 Ø 14 mm
 100 x 52 mm
 filetto/threaded
 8 mm



Art. 830/1
 Ø 22 mm
 H 100 mm
 filetto/threaded
 14MA mm



Art. 830/2
 Ø 22 mm
 H 100 mm
 filetto/threaded
 14MA mm



Art. 830/3
 filetto / threaded
 20MA mm
Art. 830/4
 filetto / threaded
 24MA mm



Art. 182/1
 60 x 100 mm
Art. 182/2
 60 x 280 mm

CARDINE a SALDARE
 HINGE for WELDING to POST

CARDINE a MURO
 HINGE for BUILDING into WALL

CARDINE PASSANTE
 HINGE to FASTEN TROUGH POST

CARDINE a REGOLAZIONE ORTOGONALE
 RIGHT-ANGLE ADJUSTMENT HINGE



Art. 164/1
 filetto/threaded
 18MA mm



Art. 164/3
 filetto/threaded
 18MA mm



Art. 164/5
 filetto/threaded
 18MA mm



Art. 830/19
 filetto / thread
 18MA mm

Art. 164/2
 filetto/threaded
 22MA mm

Art. 164/4
 filetto/threaded
 22MA threaded

Art. 164/6
 filetto/threaded
 22MA mm

Art. 830/20
 filetto / threaded
 22MA mm

Art. 830/17
 filetto/threaded
 27MA mm

Art. 830/18
 filetto/threaded
 27MA mm

Art. 830/21
 filetto / threaded
 27MA mm



con CARDINE
 with HINGE
 18MA

Art. 164/11

Art. 164/12

con CARDINE
 with HINGE
 22MA

Art. 164/13

Art. 164/9

Art. 164/10

PERNO
 PIVOT

PIASTRA
 PLATE

PIASTRA
 PLATE

con CARDINE
 with HINGE
 18MA

con CARDINE
 with HINGE
 22MA



LUCIDO - POLISHED
Art. 830/5

H 89 mm - Ø 20 mm

Art. 830/6

H 89 mm - Ø 23 mm

Art. 830/7

H 89 mm - Ø 28 mm

LUCIDO - POLISHED
Art. 830/11

H 15 mm - L 60 mm

Art. 830/12

H 20 mm - L 70 mm

Art. 830/13

H 20 mm - L 80 mm

ZINCATO - ZINC PLATED

Art. 830/8

H 89 mm - Ø 20 mm

Art. 830/9

H 89 mm - Ø 23 mm

Art. 830/10

H 89 mm - Ø 28 mm

ZINCATO - ZINC PLATED

Art. 830/14

H 15 mm - L 60 mm

Art. 830/15

H 20 mm - L 70 mm

Art. 830/16

H 20 mm - L 80 mm



CARDINI CERTIFICATI PER PORTATE ELEVATE - HINGES CERTIFIED FOR HIGH CAPACITY



Art. 181/13
 Ø 38 mm
 H 230 mm
 filetto/threaded
 22MA mm

Art. 181/14
 Ø 32 mm
 H 175 mm
 filetto/threaded
 18MA mm

PERNO
 PIVOT



con CARDINE
 with HINGE
 18MA
Art. 164/7
 da abbinare con
 to be coupled with
 art. 164/9

con CARDINE
 with HINGE
 22MA
Art. 164/8
 da abbinare con
 to be coupled with
 art. 164/10



PRODOTTI CERTIFICATI CE
 LA CERTIFICAZIONE E IL RAPPORTO DEI TEST
 SONO DISPONIBILI SUL SITO
WWW.ARTEFERRO.COM

CE CERTIFIED PRODUCTS
 CERTIFICATION AND TESTED AVAILABLE AT
WWW.ARTEFERRO.COM



	Lt 0,75	Lt 2,50
NERO Forgia Forge BLACK	227/1	227/2
GRAFITE GRAPHITE Gray	227/3	227/4
BIANCO Antico Antique WHITE	227/33	227/34
TESTA di MORO Dark BROWN	227/35	227/36
VERDE Vagone Dark GREEN	227/37	227/38
ROSSO Inglese English RED	227/39	227/40
GRIGIO Perla Pearl GREY	227/41	227/42
GRIGIO Argento Silver GREY	227/43	227/16
GRIGIO Chiaro Light GRAY	227/44	227/18
GRIGIO Nero Black GRAY	227/45	227/20
GRIGIO Scuro Dark GRAY	227/46	227/22
BRONZO BRONZE	227/47	227/24
Vernice TRASPARENTE TRASPARENT Vernish	227/48	227/49
RUGGINE Trasparente RUST COLOUR Coating	227/53	227/54
VERDE Mobili Ind.i.a.'s Furniture GREEN GRAY	227/55	227/56

	Lt 0,25	Lt 1,00	Lt 5,00
Patina ORO GOLD Patina	227/29		
Patina RAME COPPER Patina	227/30		
Patina VERDE GREEN Patina	227/31		
Patina ARGENTO SILVER Patina	227/32		
Patina VERDE RAME Opaco VERDIGRIS MAT Patina	227/50		
Patina ORO Pallido Pale GOLD Patina	227/51		
Patina ORO Antico Antique GOLD Patina	227/52		
RUGGINE Trasparente RUST COLOUR Coating	227/53		
VERDE Mobili Ind.i.a.'s Furniture GREEN GRAY	227/44		
DILUENTE Sintetico THINNER	227/27	227/28	
DILUENTE Nitro Nitro THINNER	227/57	227/58	



GOLA a "V"
"V" GROOVE

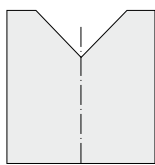

SERIE LEGGERA - n. 1 CUSCINETTO
LIGHT MODEL with nr. 1 BEARING

Cod. art. Art. no.	Ø/dia	SPESSORE WIDTH	PORTATA CAPACITY
844/1	50 mm	20 mm	200 Kg
844/2	60 mm	20 mm	300 Kg
844/3	70 mm	20 mm	300 Kg
844/34	75 mm	20 mm	300 Kg
844/4	80 mm	20 mm	300 Kg
844/5	90 mm	20 mm	300 Kg
844/6	100 mm	20 mm	300 Kg
844/7	120 mm	20 mm	300 Kg
844/8	140 mm	20 mm	300 Kg
844/9	160 mm	20 mm	300 Kg

SERIE PESANTE - n. 2 CUSCINETTI
HEAVY MODEL with nr. 2 BEARINGS

Cod. art. Art. no.	Ø/dia	SPESSORE WIDTH	PORTATA CAPACITY
844/10	100 mm	30 mm	600 Kg
844/11	120 mm	30 mm	600 Kg
844/12	140 mm	30 mm	600 Kg
844/13	160 mm	30 mm	800 Kg
844/14	200 mm	30 mm	800 Kg

SERIE PESANTE con INGRASSATORE
- n. 2 CUSCINETTI -
HEAVY MODEL with GREASE RECEIVER
- nr. 2 BEARINGS -

Cod. Art. Art. no.	Ø/dia	SPESSORE WIDTH	PORTATA CAPACITY
844/15	90 mm	30 mm	600 Kg
844/16	100 mm	30 mm	600 Kg
844/17	120 mm	30 mm	600 Kg
844/18	140 mm	30 mm	600 Kg
844/19	160 mm	30 mm	600 Kg



GOLA a "RAGGIO"
"ROUNDE" GROOVE

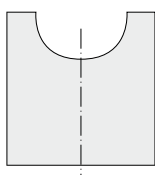

SERIE PESANTE - 10 mm
HEAVY MODEL - 10 mm

Cod. art. Art. no.	Ø/dia	SPESSORE WIDTH	PORTATA CAPACITY
844/29	100 mm	30 mm	600 Kg
844/30	120 mm	30 mm	600 Kg
844/31	140 mm	30 mm	600 Kg
844/32	160 mm	30 mm	600 Kg
844/33	200 mm	30 mm	600 Kg

SERIE LEGGERA - 7,5 mm
LIGHT MODEL - 7,5 mm

Cod. art. Art. no.	Ø/dia	SPESSORE WIDTH	PORTATA CAPACITY
844/20	50 mm	20 mm	300 Kg
844/21	60 mm	20 mm	300 Kg
844/22	70 mm	20 mm	300 Kg
844/23	80 mm	20 mm	300 Kg
844/24	90 mm	20 mm	300 Kg
844/25	100 mm	20 mm	300 Kg
844/26	120 mm	20 mm	300 Kg
844/27	140 mm	20 mm	300 Kg
844/28	160 mm	20 mm	300 Kg

**RUOTE GUIDA
SUPERIORI
CILINDRICHE**
Ø 30 mm

**CILINDRICAL UPPER
GUIDINGWHEELS**
for GATES
dia 30 mm



Art. 845/17

**RUOTE GUIDA
SUPERIORI
CILINDRICHE**
Ø 35 mm

**CILINDRICAL UPPER
GUIDINGWHEELS**
for GATES
dia 35 mm



Art. 846/4



GOLA a "V"
"V" GROOVE

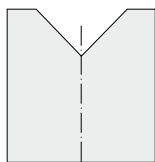

RUOTE con SUPPORTO INTERNO TIPO "F"
WHEELS with INTERNAL SUPPORT MODEL "F"

Cod. art. Art. no.	Ø/dia	SPESSORE WIDTH	CUSCINETTI BEARINGS	PORTATA CAPACITY
845/20	75 mm	20 mm	1	300 Kg
845/1	80 mm	20 mm	1	300 Kg
845/2	90 mm	20 mm	1	300 Kg
845/3	100 mm	20 mm	1	300 Kg
845/4	120 mm	20 mm	1	300 Kg
845/5	120 mm	30 mm	2	600 Kg
845/6	140 mm	20 mm	1	300 Kg
845/7	140 mm	30 mm	2	600 Kg



GOLA a "LJ"
"LJ" GROOVE

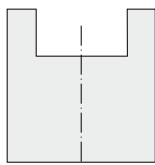

Cod. art. Art. no.	Ø/dia	SPESSORE WIDTH	GOLA GROOVE	CUSCINETTI BEARINGS	PORTATA CAPACITY
845/21	75 mm	18 mm	7 mm	1	300 Kg
845/22	100 mm	22 mm	8 mm	1	300 Kg
845/23	100 mm	30 mm	21 mm	1	300 Kg
845/24	120 mm	22 mm	8 mm	1	300 Kg
845/25	120 mm	30 mm	21 mm	1	300 Kg

PIASTRE GUIDA per CANCELLO
200 mm - 4 OLIVE

GATE GUIDING PLATE
200 mm - 4 GUIDING BEARING



Art. 845/18

PIASTRE GUIDA per CANCELLO
60 mm - 2 OLIVE

GATE GUIDING PLATE
60 mm - 2 GUIDING BEARING

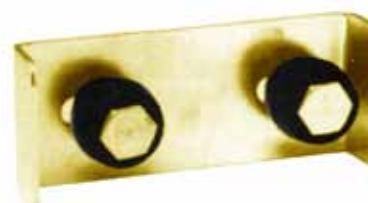

Art. 845/19

SERIE LEGGERA - LIGHT MODEL

Cod. art. Art. no.	Ø/dia	SPESSORE WIDTH	GOLA GROOVE	CUSCINETTI BEARINGS	PORTATA CAPACITY
846/6	60 mm	17 mm	6 mm	1	100 Kg
846/7	75 mm	18 mm	7 mm	1	150 Kg
846/8	90 mm	20 mm	8 mm	1	170 Kg
846/9	100 mm	22 mm	8 mm	1	200 Kg
846/10	120 mm	22 mm	8 mm	1	200 Kg
846/11	140 mm	25 mm	16 mm	1	250 Kg
846/12	160 mm	25 mm	16 mm	1	300 Kg

SERIE PESANTE - HEAVY MODEL

Cod. art. Art. no.	Ø/dia	SPESSORE WIDTH	GOLA GROOVE	CUSCINETTI BEARINGS	PORTATA CAPACITY
846/13	90 mm	25 mm	16 mm	1	200 Kg
846/14	120 mm	30 mm	21 mm	1	400 Kg
846/15	160 mm	30 mm	21 mm	1	500 Kg
846/16	200 mm	30 mm	21 mm	1	600 Kg
846/17	250 mm	32 mm	22 mm	1	800 Kg



GOLA a "LJ"
"LJ" GROOVE

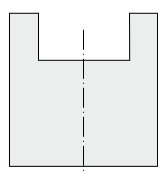

PIASTRE GUIDA per CANCELLO
4 OLIVE

GATE GUIDING PLATE
4 GUIDING BEARING

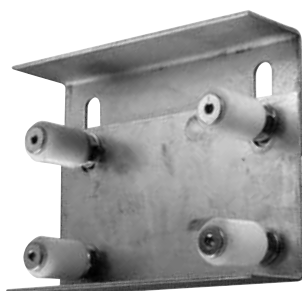

Art. 846/5

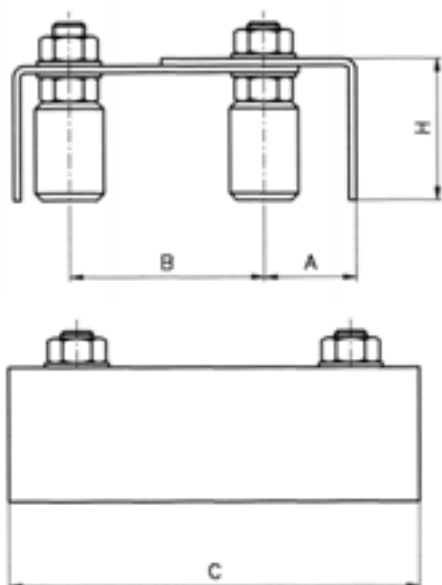

A	40 ÷ 80 mm
B	40 ÷ 50 mm
C	220 mm
H	59 mm



GOLA a "V"
"V" GROOVE

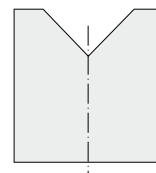

RUOTE con SUPPORTO INTERNO TIPO "I"
WEELS with INTERNAL SUPPORT MODEL "I"

Cod. art. Art. no.	Ø/dia	SPESSORE WIDTH	GOLA GROOVE	CUSCINETTI BEARINGS	PORTATA CAPACITY
845/8	60 mm	20 mm	20 mm	1	300 Kg
845/9	70 mm	20 mm	20 mm	1	300 Kg
845/10	80 mm	20 mm	20 mm	1	400 Kg
845/11	90 mm	20 mm	20 mm	1	400 Kg
845/12	100 mm	20 mm	20 mm	1	400 Kg
845/13	120 mm	20 mm	20 mm	1	400 Kg
845/14	120 mm	30 mm	30 mm	2	600 Kg
845/15	140 mm	20 mm	20 mm	1	400 Kg
845/16	140 mm	30 mm	30 mm	2	600 Kg



GOLA a "L"
"L" GROOVE

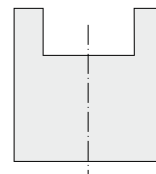

Cod. art. Art. no.	Ø/dia	SPESSORE WIDTH	GOLA GROOVE	CUSCINETTI BEARINGS	PORTATA CAPACITY
845/26	75 mm	18 mm	8 mm	1	180 Kg
845/27	90 mm	20 mm	8 mm	1	200 Kg
845/28	100 mm	22 mm	8 mm	1	220 Kg
845/29	120 mm	25 mm	16 mm	2	400 Kg
845/30	140 mm	25 mm	16 mm	2	420 Kg

GOLA a "L"
"L" GROOVE

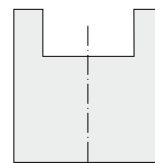

GOLA a "V"
"V" GROOVE

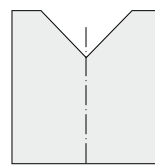

Cod. art. Art. no.	Ø/dia	SPESSORE WIDTH	GOLA GROOVE	CUSCINETTI BEARINGS	PORTATA CAPACITY
846/18	75 mm	25 mm	13 mm	1	200 Kg
846/19	75 mm	25 mm	16 mm	1	200 Kg
846/20	100 mm	25 mm	16 mm	1	400 Kg

Cod. art. Art. no.	Ø/dia	SPESSORE WIDTH	GOLA GROOVE	CUSCINETTI BEARINGS	PORTATA CAPACITY
846/21	75 mm	25 mm		1	200 Kg
846/22	100 mm	25 mm		2	400 Kg

Art. 869/1

150 kg



Art. 869/2

H 500 mm

Ø 500 mm

Art. 870/1

50 kg



Art. 870/2

H 580 mm

Ø 350 mm

Art. 870/3

100 kg

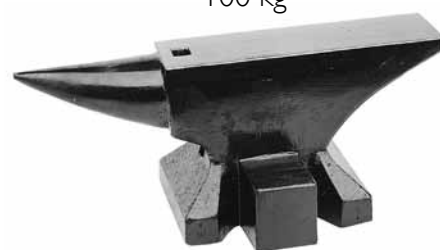

Art. 870/4

H 530 mm

Ø 400 mm

Ø = diameter

INCUDINI
SAGOMATORI



Art. 872/1

Ø 5 mm



Art. 872/2

Ø 10 mm



Art. 872/3

Ø 20 mm



Art. 872/4

Ø 25 mm



Art. 872/5

Ø 30 mm

MODELLING
ANVILS



Art. 872/6

Ø 5 mm



Art. 872/7

Ø 10 mm



Art. 872/8

Ø 15 mm



Art. 872/9

Ø 20 mm



Art. 872/10

Ø 25 mm



Art. 872/11

Ø 30 mm



DIMA
CALIBRATRICE
FORGING TOOLS
and EQUIPEMENT

Art. 871/1

H 840 mm

L 350 mm

INCUDINE PIANO
PLAIN ANVIL



Art. 873/1

INCUDINE INCISORE
ENGRAVING ANVIL



Art. 873/2

INCUDINE INCISORE
ENGRAVING ANVIL



Art. 873/3



ARTEFERRO

SCALPELLI SAGOMATORI PIANI
FLAT MODELLING CHISELS

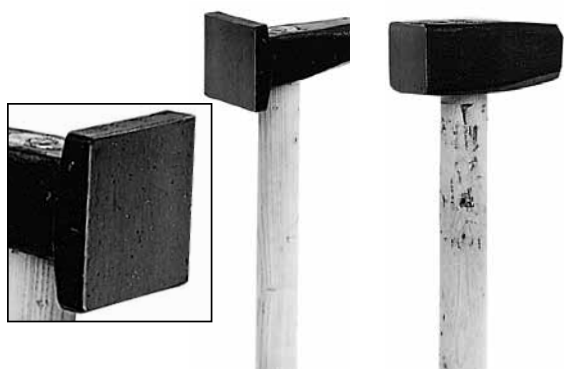

Art. 874/4
70 x 70 mm

Art. 874/5
50 x 50 mm

MAZZETTE - LITTLE SLEDGEHAMMERS



Art. 874/1
1,5 kg

Art. 874/2
1,5 kg

Art. 874/3
2,0 kg

SCALPELLI A COLTELLO - KNIFE SHAPED CHISELS



Art. 875/7
1,0 kg

Art. 875/8
1,5 kg

Art. 875/9
2,0 kg

MAZZE - SLEDGEHAMMERS



Art. 875/1
3,0 kg

Art. 875/2
4,0 kg

Art. 875/3
5,0 kg

SCALPELLI INCISORI - ENGRAVING CHISELS



Art. 875/10
1,0 kg

Art. 875/11
1,5 kg

Art. 875/12
2,0 kg



Art. 875/4
6,0 kg

Art. 875/5
8,0 kg

Art. 875/6
10,0 kg

SCALPELLI SAGOMATORI - MODELLING CHISELS

Ø = diameter

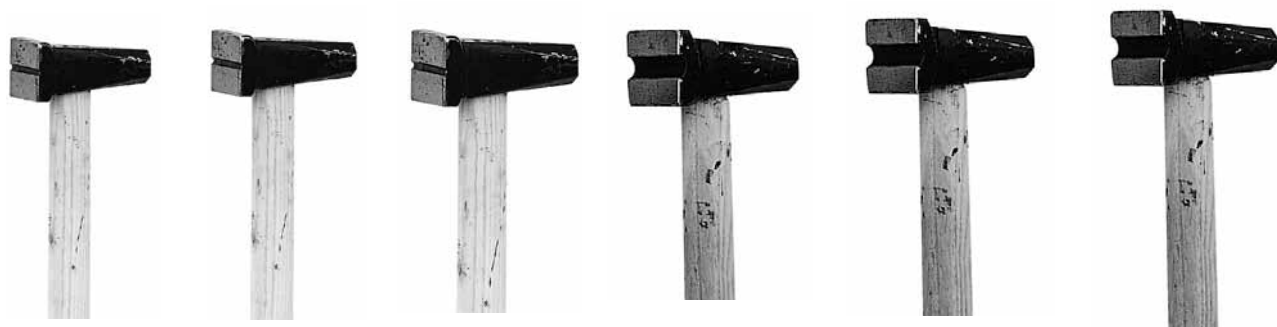

Art. 876/6
Ø 5 mm

Art. 876/7
Ø 10 mm

Art. 876/8
Ø 15 mm

Art. 876/9
Ø 20 mm

Art. 876/10
Ø 25 mm

Art. 876/11
Ø 30 mm



Art. 876/1
Ø 5 mm



Art. 876/2
Ø 10 mm



Art. 876/3
Ø 20 mm



Art. 876/4
Ø 25 mm



Art. 876/5
Ø 30 mm

Ø = diameter

CACCIACUNEO a PUNTA QUADRA
SQUARE TIPPED COTTERS DRIVER



Art. 877/1
□ 10 mm



Art. 877/2
□ 15 mm



Art. 877/3
□ 20 mm



Art. 877/4
□ 25 mm

CACCIACUNEO a PUNTA TONDA
ROUND TIPPED COTTERS DRIVER



Art. 877/5
Ø 10 mm



Art. 877/6
Ø 15 mm



Art. 877/7
Ø 20 mm



Art. 877/8
Ø 25 mm

TENAGLIE STAMPATE - L 500 mm
HOT STAMPED BLACKSMITH'S TONGS - L 500 mm



Art. 878/1



Art. 878/5



Art. 878/2



Art. 878/6



Art. 878/3



Art. 878/7



Art. 878/4



Art. 878/8

TENAGLIE FORGIATE - L 450 mm
FORGED BLACKSMITH'S TONGS - L 500 mm

Art. 879/1



Art. 879/2



Art. 879/3



FORNO SINGOLO - SINGLE OVEN
Art. 1559/1

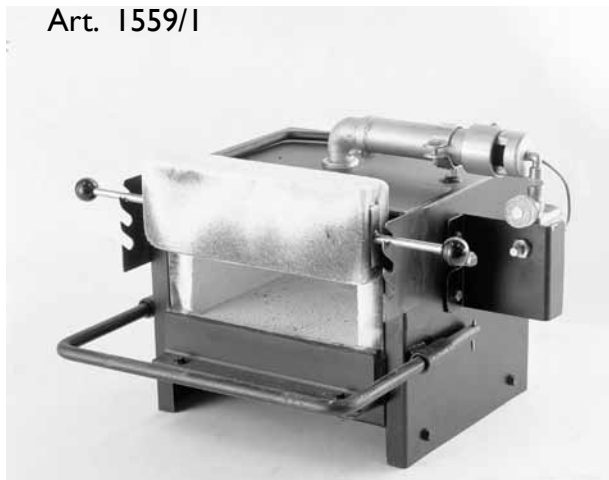

Misure esterne - External measures:
L 310 mm - H 255 mm - P 255 mm
Misure interne - Internal measures:
L 200 mm - H 250 mm - P 90 mm

FORNO DOPPIO - DOUBLE OVEN
Art. 1559/2

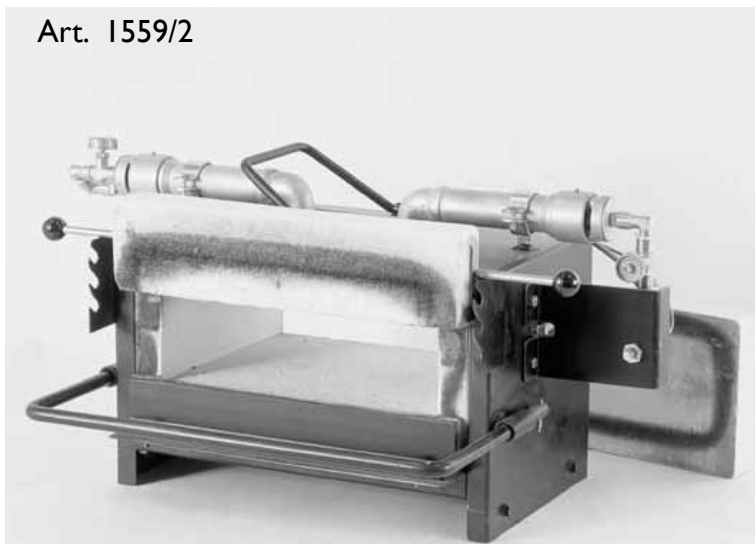

Misure esterne - External measures:
L 410 mm - H 255 mm - P 255 mm
Misure interne - Internal measures:
L 300 mm - H 250 mm - P 90 mm

PICCOLA "FORGIA"
SMALL "FORGE"

TRASPORTABILE a MANO
TRANSPORTABLE by HAND

CARATTERISTICHE PRINCIPALI:
MAIN FEATURES:

- Temperatura massima 1300 °C
- Maximum Temperature 1300°C
- Accensione facilitata
- Easy ignition
- Dispositivo di sicurezza in caso di spegnimento accidentale
- Safety device, in case of any sudden or accidental malfunction
- Forno a passaggio totale (avanti / dietro) per l'inserimento anche di verghe lunghe
- Opening on two sides (front / back) to insert long bars
- La camera di combustione è isolata con pannelli in fibrocera e base in refrattario
- The combustion chamber is isolated with ceramic fiber panels made of refractory material
- Lo schermo a chiusura regolabile permette un risparmio di energia e garantisce la massima sicurezza
- The front screen with its adjustable opening, allow for energy saving and guarantees the maximum security)

I FORNI RISPONDONO ALLE VIGENTI
NORMATIVE INTERNAZIONALI DI SICUREZZA
THE OVENS CORRESPOND TO THE
INTERNATIONAL SECURITY SAFETY LAW (EC)

Direttive CEE 89/392 modificate con Direttive
CEE 91/368 e 93/68, Direttive CEE 89/336
modificate dalle Direttive CEE 93/68

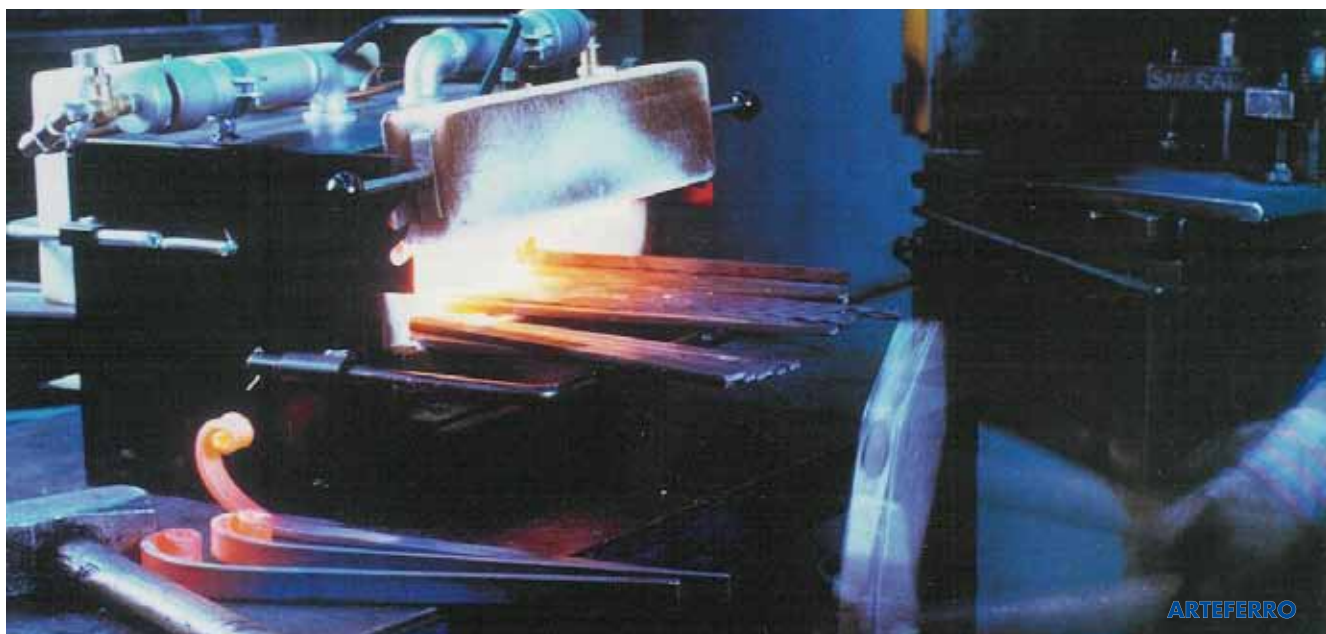

ARTEFERRO

GUANTI da LAVORO - WORKING WELDING and DRIVING GLOVES



Crosta di Maiale
Swine skin
Art. 880/1



Crosta di Maiale
Swine skin
Art. 880/2



Cotone e Lattice
Cotton and latex
Art. 880/3



Lungo per saldatura
Welding glove-long
Art. 880/4



Corto per saldatura
Welding glove-short
Art. 880/5

DISCHI da TAGLIO CUT-OFF WHEELS

Art. 881/1
Ø 115 mm
3,40 x 22 mm

Art. 881/2
Ø 230 mm
3,40 x 22 mm

Art. 881/3
Ø 300 mm
3,00 x 22 mm
fissi /fix

DISCHI SMERIGLIO GRINDING WHEELS

Art. 881/4
Ø 115 mm
6,00 x 22 mm

Art. 881/5
Ø 230 mm
6,00 x 22 mm



DISCHI LAMELLARI LAMINATED WHEELS

Art. 881/6
Ø 115 x 22 mm
grana/grain 40

Art. 881/7
Ø 230 x 22 mm
grana/grain 60

Art. 881/8
Ø 115 x 22 mm
grana/grain 80

Art. 881/9
Ø 115 x 22 mm
grana/grain 120



Ø = diameter

ELETTRODI per SALDATURA - WELDING ELECTRODES



Cod. art./Art. no.	882/1	882/2	882/3
Misure Dimensions	Ø 2,5 mm L 300 mm	Ø 3,25 mm L 350 mm	Ø 3,25 mm L 400 mm
Scatole sul bancale - Boxes per pallet	240	234	160
Pezzi in ogni scatola - Pieces per box	290	180	157
Peso per bancale - Height of pallet	1200 kg	1200 kg	1200 kg

ZINCO LIQUIDO SPRAY
Ideale per piccoli ritocchi
LIQUID ZINC SPRAY
Perfect for "touch-ups"



Art. 185/9

ANTI SPRUZZO di
SALDATURA
ANTI STICK SPRAY
for WELDING



Art. 883/1

SPRAY SBLOCCANTE
UNLOCKING SPRAY



Art. 883/3

ANCORANTE CHIMICO
QUICK CEMENT



Art. 883/4

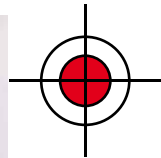

REIMESSKO

Sistema brevettato
DIMA e MISURATORE
 per ringhiera di Scale

STAIRCASE
TEMPLATE and MEASURING
Patented System

Art. 882/4

kit di due casse inclusi gli utensili
 per il montaggio

Set of two cases including tools for fastening



Il sistema REIMESSKO permette di:

- costruire, dall'inizio alla fine, la ringhiera di una scala, anche a sviluppo irregolare, completamente nella propria officina
- montare velocemente la ringhiera in cantiere;
- risparmiare, per ogni ringhiera, anche 8 - 10 ore di manodopera

The patented REIMESSKO system it is possible to:

- completely build the staircase in the workshop
- easily install the staircase in site with a small amount of handling
- for every staircase you build you can save 8 - 10 hours

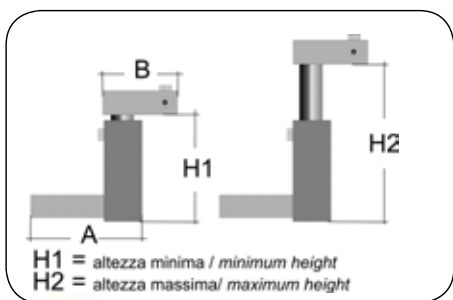

Art. 1905/2

A = 120 mm
 B = 85 mm
 H1 = 160 mm
 H2 = 235 mm



Art. 1905/3

A = 210 mm
 B = 155 mm
 H1 = 160 mm
 H2 = 235 mm



Art. 1905/4

A = 90 mm
 B = 55 mm
 H1 = 160 mm
 H2 = 235 mm



Art. 1905/5

A = 150 mm
 B = 85 mm
 H1 = 160 mm
 H2 = 235 mm



Art. 1905/6

A = 90 mm
 B = 55 mm
 H1 = 160 mm
 H2 = 235 mm



Art. 1905/7

A = 90 mm
 B = 55 mm
 H1 = 310 mm
 H2 = 500 mm



Art. 1905/1

A = 120 mm
 B = 55 mm
 H1 = 160 mm
 H2 = 235 mm



Art. 1905/8

L 200 mm



Art. 1905/9

L 150 mm



Art. 1905/10

L 100 mm



Art. 1905/12

L 80 mm



Art. 1905/13

L 50 mm



Art. 1905/14



Art. 1905/15



Art. 1905/16

foro/hole 35 x 35 mm
 H 100 mm
 Flange Ø 140 mm



Art. 1905/17

foro/hole
 35 x 35 mm



Art. 1905/18

foro/hole
 35 x 35 mm



Art. 1905/19

ELEMENTI VARI - VARIOUS ELEMENTS



- 6 x 20 mm - **Art. 41/17**
- 6 x 25 mm - **Art. 41/18**
- 6 x 30 mm - **Art. 41/19**
- 6 x 35 mm - **Art. 41/20**
- 6 x 40 mm - **Art. 41/21**
- 6 x 45 mm - **Art. 41/22**
- 6 x 50 mm - **Art. 41/23**
- 6 x 60 mm - **Art. 41/24**

7 x 25 mm - **Art. 41/13**

- 8 x 8 mm - **Art. 41/14** - (disponibile anche in ottone / available also in brass)
- 8 x 20 mm - **Art. 41/15** - (disponibile anche in ottone / available also in brass)
- 8 x 25 mm - **Art. 41/1** - (disponibile anche in ottone / available also in brass)
- 8 x 30 mm - **Art. 41/4** - (disponibile anche in ottone / available also in brass)
- 8 x 35 mm - **Art. 41/5** - (disponibile anche in ottone / available also in brass)
- 8 x 40 mm - **Art. 41/6** - (disponibile anche in ottone / available also in brass)
- 8 x 45 mm - **Art. 41/16** - (disponibile anche in ottone / available also in brass)
- 8 x 50 mm - **Art. 41/7** - (disponibile anche in ottone / available also in brass)
- 8 x 60 mm - **Art. 41/8** - (disponibile anche in ottone / available also in brass)



Art. 41/10
6 x 40 mm

Art. 41/9
8 x 40 mm



Art. 695/12
13 x 63 mm



testa
head
Ø 17 mm

Art. 41/11
L 25 mm
Ø 8 mm

Art. 41/12
L 30 mm
Ø 8 mm



una punta
one point

Art. 171/37
12 x 12 mm

Art. 171/38
15 x 15 mm

Art. 171/39
20 x 20 mm



due punte
two points

Art. 171/40
15 x 15 mm

Art. 171/41
20 x 20 mm

Art. 171/42
25 x 25 mm



CHIODI FORGIATI / HAND FORGED RIVETS

Art. 1474/6

Testa/Head 30 mm
L 285 mm
sez./sect. 14 x 14 mm

Art. 1474/7

Testa/Head 30 mm
L 210 mm
sez./sect. 12 x 12 mm

Art. 1474/8

Testa/Head 25 mm
L 160 mm
sez./sect. 10 x 10 mm

Art. 1474/9

Testa/Head 20 mm
L 105 mm
sez./sect. 8 x 8 mm

Art. 1474/10

Testa/Head 13 mm
L 70 mm
sez./sect. 5 x 5 mm

Ø = diameter

VITI AUTOFILETTANTI / SELF-TAPPING SCREW



Art. 695/6
Testa/Head
30 x 30 mm
L 90 mm
Ø 10 mm



Art. 695/7
Testa/Head
22 x 22 mm
L 75 mm
Ø 8 mm



Art. 695/8
Testa/Head
16 x 16 mm
L 62 mm
Ø 8 mm



Art. 695/9
Testa/Head
Ø 35 mm
L 90 mm
Ø 10 mm



Art. 695/10
Testa/Head
Ø 24 mm
L 85 mm
Ø 8 mm



Art. 695/11
Testa/Head
Ø 18 mm
L 62 mm
Ø 8 mm



Art. 1405/1
 Base 25 x 8 mm
 Fori/Holes Ø 8,5 mm
 φ 12 x 12 mm



Art. 1405/2
 Base Ø 80 mm
 Fori/Holes Ø 8,5 mm
 φ 12 x 12 mm



Art. 1405/3
 Base Ø 80 mm
 Fori/Holes Ø 8,5 mm
 Ø 16 mm

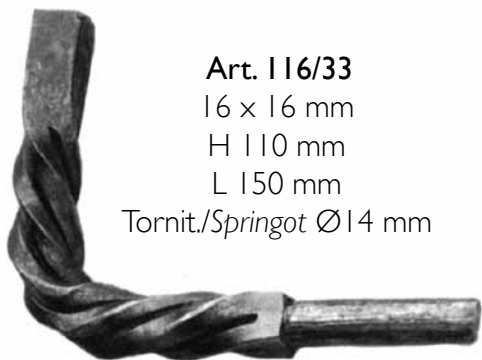

Art. 116/33
 16 x 16 mm
 H 110 mm
 L 150 mm
 Tornit./Springot Ø14 mm

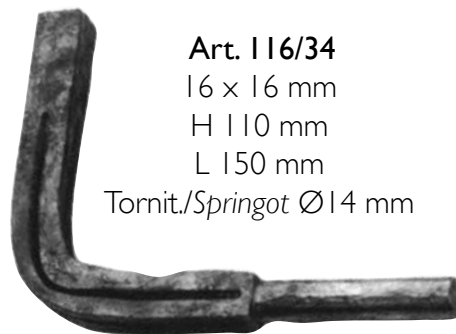

Art. 116/34
 16 x 16 mm
 H 110 mm
 L 150 mm
 Tornit./Springot Ø14 mm



Art. 116/35
 Ø 65 mm
 8 mm
 Foro/Hole Ø 15 mm

Ø = diameter



Art. 94/A/1
 H 160 mm
 L 95 mm



Art. 94/A/2
 H 160 mm
 L 95 mm



ARTEFERRO



Art. 82/2
10 x 5 mm
H 105 mm



Art. 30/6
8 x 8 mm
H 75 mm



Art. 81/2
8 x 8 mm
H 125 mm



Art. 83/9
8 x 8 mm
H 120 mm



Art. 83/2
8 x 8 mm
H 120 mm



Art. 83/4
8 x 8 mm
H 120 mm



Art. 83/6
8 x 8 mm
H 120 mm



Art. 83/13
8 x 8 mm
H 120 mm



Art. 83/11
8 x 8 mm
H 120 mm



Art. 89/4
8 x 8 mm
H 55 mm



Art. 83/10
8 x 8 mm
H 60 mm



Art. 83/3
8 x 8 mm
H 60 mm



Art. 83/5
8 x 8 mm
H 60 mm



Art. 83/7
8 x 8 mm
H 60 mm



Art. 83/8
8 x 8 mm
H 60 mm



Art. 83/12
8 x 8 mm
H 60 mm



Art. 81/6
8 x 8 mm
L 120 mm



Art. 81/8
8 x 8 mm
L 110 mm



Art. 82/8
20 x 3 mm
L 135 mm



Art. 198/1
20 x 6 mm
L 140 mm



Art. 85/1
8 x 8 mm
L 125 mm



Art. 34/3
12 x 12 mm
H 175 mm
L 110 mm



Art. 81/4
8 x 8 mm
L 90 mm



Art. 82/6
Ø 10 mm
L 90 mm

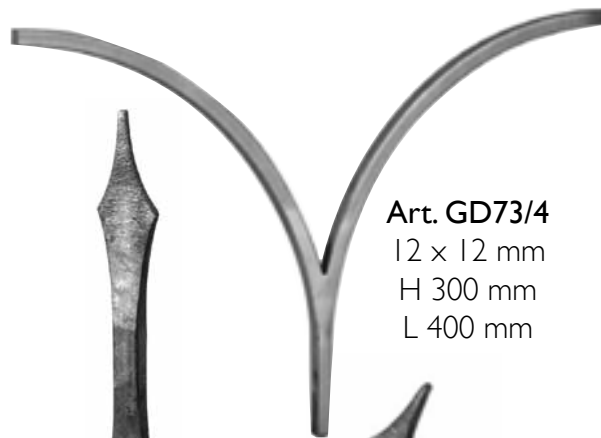

Art. GD73/4
12 x 12 mm
H 300 mm
L 400 mm

Art. 82/4
Ø 8 mm
L 90 mm



Art. 88/L/2
14 x 8 mm
L 135 mm



Art. 85/6
12 x 12 mm
L 225 mm



Art. 40/B/8
12 x 12 mm
L 220 mm



Art. 70/B/7
12 x 12 mm
190 x 70 mm

Art. 40/B/8
14 x 14 mm
L 220 mm



ARTEFERRO



Art. 852/8

spess./thick. 6 mm
H 70 mm - L 1218 mm

Art. 852/9

spess./thick. 2 mm
H 45 mm - L 1212 mm



Art. 852/10

spess./thick. 8 mm
H 124 mm - L 1206 mm

Art. 852/11

spess./thick. 2 mm
H 45 mm - L 1215 mm



Art. 852/6

spess./thick. 6 mm
H 84 mm - L 1152 mm

Art. 852/7

spess./thick. 2 mm
H 45 mm - L 1213 mm



Art. 852/12

spess./thick. 6 mm
H 70 mm - L 1196 mm

Art. 852/13

spess./thick. 2 mm
H 45 mm - L 1212 mm



Art. 852/14

spess./thick. 6 mm
H 84 mm - L 1160 mm

Art. 852/15

spess./thick. 2 mm
H 45 mm - L 1242 mm

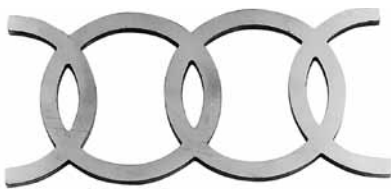

Art. 852/4

spess./thick. 8 mm
H 124 mm - L 1129 mm



Art. 852/5

spess./thick. 6 mm
H 84 mm - L 1140 mm



ARTEFERRO



Art. 1813/1

14 x 6 mm
H 155 mm
L 755 mm

Art. 1813/3

14 x 6 mm
H 155 mm
L 580 mm

Art. 1813/4

14 x 6 mm
H 155 mm
L 415 mm



Art. 1813/2

14 x 6 mm
H 155 mm
L 250 mm



Art. 1813/6

14 x 6 mm
H 190 mm
L 960 mm

Art. 1813/5

14 x 6 mm
H 190 mm
L 580 mm



ARTEFERRO



spess./thick. 3 mm - H 55 mm - L 1000 mm

Art. 1409/1
liscio/plain

Art. 1410/1
coniato/hammered



spess./thick. 3 mm - H 55 mm - L 990 mm

Art. 1409/2
liscio/plain

Art. 1410/2
coniato/hammered



spess./thick. 3 mm - H 55 mm - L 990 mm

Art. 1409/3
liscio/plain

Art. 1410/3
coniato / hammered



spess./thick. 3 mm - H 45 mm - L 990 mm

Art. 1409/4
liscio/plain

Art. 1410/4
coniato/hammered



spess./thick. 3 mm - H 37 mm - L 990 mm

Art. 1409/5
liscio/plain

Art. 1410/5
coniato/hammered



spess./thick. 3 mm - H 63 mm - L 960 mm

Art. 1409/6
liscio/plain

Art. 1410/6
coniato/hammered



spess./thick. 3 mm - H 55 mm - L 960 mm

Art. 1409/7
liscio/plain

Art. 1410/7
coniato / hammered



spess./thick. 3 mm - H 55 mm - L 993 mm

Art. 1409/8
liscio/plain

Art. 1410/8
coniato/hammered



Art. 1411/1

12 x 6 mm - H 165 mm - L 1230 mm



Art. 1411/2

12 x 6 mm - H 165 mm - L 1160 mm - incl. 30°



Art. 1411/3

spess./thickness 2 mm - H 45 mm - L 1230 mm



Art. 1411/5

spess./thickness 6 mm - H 84 mm - L 1225 mm
incl. 30°

Art. 1411/4

spess./thickness 6 mm - H 84 mm - L 1250 mm



Art. 1411/6

10 x 5 mm
H 200 mm
L 200 mm



Art. 1411/9

spess./thick.
5 mm
Ø 100 mm



12 x 12 mm

Art. 1321/1

100 x 100 mm

Art. 1321/3

120 x 125 mm

14 x 14 mm

Art. 1321/2

100 x 100 mm

Art. 1321/4

120 x 125 mm

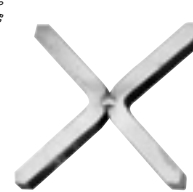

12 x 12 mm

Art. 1321/5

100 x 100 mm

Art. 1321/7

120 x 125 mm

14 x 14 mm

Art. 1321/6

100 x 100 mm

Art. 1321/8

120 x 125 mm



12 x 12 mm

Art. 1321/9

100 x 100 mm

Art. 1321/11

120 x 125 mm

14 x 14 mm

Art. 1321/10

100 x 100 mm

Art. 1321/12

120 x 125 mm





Art. 1412/1
coniato
hammered

Art. 1413/1
liscio/plain

H 240 x L 215 mm



Art. 1412/4
coniato
hammered

Art. 1413/4
liscio/plain

H 240 x L 240 mm



Art. 1412/7
coniato
hammered

Art. 1413/7
liscio/plain

H 225 x L 175 mm



Art. 1412/10
coniato
hammered

Art. 1413/10
liscio/plain

H 225 x L 150 mm



Art. 1412/13
coniato
hammered

Art. 1413/13
liscio/plain

H 215 x L 200 mm



Art. 1412/16
coniato
hammered

Art. 1413/16
liscio/plain

H 240 x L 210 mm



Art. 1412/19
coniato
hammered

Art. 1413/19
liscio/plain

H 235 x L 125 mm



Art. 1412/22
coniato
hammered

Art. 1413/22
liscio/plain

H 200 x L 225 mm



Art. 1412/25
coniato
hammered

Art. 1413/25
liscio/plain

H 235 x L 150 mm



Art. 1412/2
coniato
hammered

Art. 1413/2
liscio/plain

H 215 x L 215 mm



Art. 1412/5
coniato
hammered

Art. 1413/5
liscio/plain

H 240 x L 135 mm



Art. 1412/8
coniato
hammered

Art. 1413/8
liscio/plain

H 235 x L 185 mm



Art. 1412/11
coniato
hammered

Art. 1413/11
liscio/plain

H 225 x L 200 mm



Art. 1412/14
coniato
hammered

Art. 1413/14
liscio/plain

H 230 x L 165 mm



Art. 1412/17
coniato
hammered

Art. 1413/17
liscio/plain

H 245 x L 195 mm



Art. 1412/20
coniato
hammered

Art. 1413/20
liscio/plain

H 230 x L 165 mm



Art. 1412/23
coniato
hammered

Art. 1413/23
liscio/plain

H 220 x L 220 mm



Art. 1412/26
coniato
hammered

Art. 1413/26
liscio/plain

H 220 x L 180 mm



Art. 1412/3
coniato
hammered

Art. 1413/3
liscio/plain

H 240 x L 160 mm



Art. 1412/6
coniato
hammered

Art. 1413/6
liscio/plain

H 230 x L 185 mm



Art. 1412/9
coniato
hammered

Art. 1413/9
liscio/plain

H 215 x L 120 mm



Art. 1412/12
coniato
hammered

Art. 1413/12
liscio/plain

H 215 x L 190 mm



Art. 1412/15
coniato
hammered

Art. 1413/15
liscio/plain

H 245 x L 170 mm



Art. 1412/18
coniato
hammered

Art. 1413/18
liscio/plain

H 225 x L 195 mm



Art. 1412/21
coniato
hammered

Art. 1413/21
liscio/plain

H 210 x L 170 mm



Art. 1412/24
coniato
hammered

Art. 1413/24
liscio/plain

H 210 x L 200 mm



Art. 1412/27
coniato
hammered

Art. 1413/27
liscio/plain

H 250 x L 250 mm



Art. 1414/1
coniato
hammered

Art. 1414/12
liscio/plain

H 250 x L 80 mm



Art. 1414/2
coniato
hammered

Art. 1414/13
liscio/plain

H 250 x L 130 mm



Art. 1414/3
coniato
hammered

Art. 1414/14
liscio/plain

H 250 x L 135 mm



Art. 1414/4
coniato
hammered

Art. 1414/15
liscio/plain

H 250 x L 125 mm



Art. 1414/5
coniato
hammered

Art. 1414/16
liscio/plain

H 250 x L 95 mm



Art. 1414/6
coniato
hammered

Art. 1414/17
liscio/plain

H 250 x L 120 mm



Art. 1414/7
coniato
hammered

Art. 1414/18
liscio/plain

H 250 x L 90 mm



Art. 1414/8
coniato
hammered

Art. 1414/19
liscio/plain

H 250 x L 110 mm



Art. 1414/9
coniato
hammered

Art. 1414/20
liscio/plain

H 250 x L 110 mm



Art. 1414/10
coniato
hammered

Art. 1414/21
liscio/plain

H 250 x L 120 mm



Art. 1412/28
coniato
hammered

Art. 1413/28
liscio/plain

H 220 x L 170 mm



Art. 1414/12
coniato
hammered

Art. 1414/22
liscio/plain

H 315 x L 2450 mm

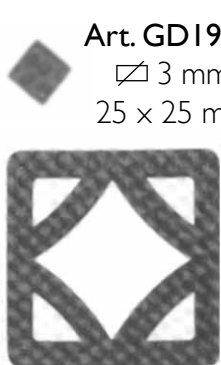

Art. GD199/1

∅ 3 mm
25 x 25 mm



Art. GD199/3

∅ 3 mm
60 x 160 mm



Art. GD199/4

∅ 3 mm
60 x 160 mm



Art. GD199/5

∅ 3 mm
120 x 160 mm



Art. GD199/6

∅ 3 mm
150 x 230 mm

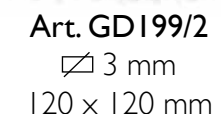

Art. GD199/2

∅ 3 mm
120 x 120 mm



Art. GD199/12

fasciette per
collars for



Art. GD199/7

∅ 3 mm
30 x 70 mm



Art. GD199/8

∅ 3 mm
80 x 70 mm



Art. GD199/10

fasciette per
collars for



Art. GD199/11

∅ 3 mm
45 x 25 mm



Art. GD199/16

∅ 3 mm
75 x 230 mm



Art. GD199/17

∅ 3 mm
75 x 230 mm



Art. GD199/13

∅ 3 mm
40 x 105 mm



Art. GD199/14

∅ 3 mm
40 x 105 mm



Art. GD199/9

fasciette per
collars for



Art. GD199/15

∅ 3 mm
80 x 105 mm

Da art. 850/1 ad art. 850/26 : spessore 6 mm - H 170 mm - L 130 mm / thickness 6 mm - H 170 mm - L 130 mm

● Da art. 850/27 ad art. 850/52 : spessore 3 mm - H 80 mm - L 55 mm / thickness 3 mm - H 80 mm - L 55 mm
e disegno diverso rispetto all'immagine / and drawing different from picture)



Art. 850/1

● Art. 850/27



Art. 850/2

● Art. 850/28



Art. 850/3

● Art. 850/29



Art. 850/4

● Art. 850/30



Art. 850/5

● Art. 850/31



Art. 850/6

● Art. 850/32



Art. 850/7

● Art. 850/33



Art. 850/8

● Art. 850/34



Art. 850/9

● Art. 850/35



Art. 850/10

● Art. 850/36



Art. 850/11

● Art. 850/37



Art. 850/12

● Art. 850/38



Art. 850/13

● Art. 850/39



Art. 850/14

● Art. 850/40



Art. 850/15

● Art. 850/41



Art. 850/16

● Art. 850/42



Art. 850/17

● Art. 850/43



Art. 850/18

● Art. 850/44



Art. 850/19

● Art. 850/45



Art. 850/20

● Art. 850/46



Art. 850/21

● Art. 850/47



Art. 850/22

● Art. 850/48



Art. 850/24

● Art. 850/50



Art. 850/25

● Art. 850/51



Art. 850/26

● Art. 850/52



Art. 850/23

● Art. 850/49

NUMERI
NUMBERS
☐ 3 mm



Art. 851/12

H 143 L 186
per un numero
for one number

Art. 851/13

H 169 L 212
fino a 3 numeri
up to 3 numbers

Art. 851/14

H 169 L 302
fino a 5 numeri
up to 5 numbers

Art. 851/15

H 169 L 392
fino a 7 numeri
up to 7 numbers



Art. 851/16

H 145 - L 193
fino a 3 numeri
up to 3 numbers

Art. 851/17

H 145 - L 273
fino a 5 numeri
up to 5 numbers

Art. 851/18

H 151 - L 353
fino a 7 numeri
up to 7 numbers



Art. 851/11
80 x 40 mm



Art. 851/1
80 x 40 mm



Art. 851/2
80 x 40 mm



Art. 851/3
80 x 40 mm



Art. 851/4
80 x 40 mm



Art. 851/5
80 x 40 mm



Art. 852/1
☐ 12 mm
H 290 mm
L 230 mm



Art. 851/6
80 x 40 mm



Art. 851/7
80 x 40 mm



Art. 851/8
80 x 40 mm



Art. 851/9
80 x 40 mm



Art. 851/10
80 x 40 mm



Art. 852/2
☐ 12 mm
H 240 mm
L 180 mm



H 60 / 100 mm

● SOLO PER QUANTITA'
ONLY FOR QUANTITIES

Art. 848/1



H 405 mm - L 255 mm
P 90 mm
ghisa/cast iron

- Lettera / Letter "A" Art. 171/11
- Lettera / Letter "B" Art. 171/12
- Lettera / Letter "C" Art. 171/13
- Lettera / Letter "D" Art. 171/14
- Lettera / Letter "E" Art. 171/15
- Lettera / Letter "F" Art. 171/16
- Lettera / Letter "G" Art. 171/17
- Lettera / Letter "H" Art. 171/18
- Lettera / Letter "I" Art. 171/19
- Lettera / Letter "J" Art. 171/20
- Lettera / Letter "K" Art. 171/21
- Lettera / Letter "L" Art. 171/22
- Lettera / Letter "M" Art. 171/23
- Lettera / Letter "N" Art. 171/24
- Lettera / Letter "O" Art. 171/25
- Lettera / Letter "P" Art. 171/26
- Lettera / Letter "Q" Art. 171/27
- Lettera / Letter "R" Art. 171/28
- Lettera / Letter "S" Art. 171/29
- Lettera / Letter "T" Art. 171/30
- Lettera / Letter "U" Art. 171/31
- Lettera / Letter "V" Art. 171/32
- Lettera / Letter "W" Art. 171/33
- Lettera / Letter "X" Art. 171/34
- Lettera / Letter "Y" Art. 171/35
- Lettera / Letter "Z" Art. 171/36



Art. 849/1
Bianco/White

Art. 849/2
Nero/Black

Art. 849/3
Rosso/Red

Art. 849/4
Verde/Green



Art. 848/2
H 455 mm - L 400 mm
P 155 mm
ghisa/cast iron



H 120 mm

- No. "1" Art. 171/1
- No. "2" Art. 171/2
- No. "3" Art. 171/3
- No. "4" Art. 171/4
- No. "5" Art. 171/5
- No. "6" Art. 171/6
- No. "7" Art. 171/7
- No. "8" Art. 171/8
- No. "9" Art. 171/9
- No. "0" Art. 171/0



Art. 5069/3
H 1100 mm
Base 330 x 240 mm
ghisa/cast iron



Art. 10314/1
762 x 762 mm



Art. 10314/2
698 x 965 mm



Art. 10314/3
482 x 673 mm



Art. 10314/4
546 x 546 mm



Art. 10315/1
635 x 508 mm



Art. 10315/2
635 x 546 mm

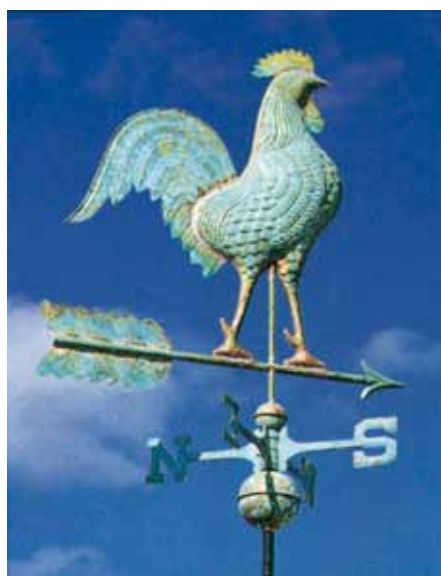

Art. 10315/3
685 x 698 mm



Art. 10316/1
787 x 571 mm



Art. 10315/6
558 x 520 mm



Art. 10315/4
736 x 558 mm



Art. 10316/7
610 x 570 mm



Art. 10316/8
558 x 533 mm



Art. 10316/3
635 x 406 mm



Art. 10316/4
774 x 444 mm



Art. 10316/5
698 x 406 mm



Art. 10316/2
736 x 520 mm

ACCESSORI - ACCESSORIES



Art. 10314/5
127 mm



Art. 10314/6
305 mm



Art. 10314/7
305 mm



Art. 10314/8
305 mm

ARIETE - ARIES



spess./thick. 3 mm
Ø 260 mm

Art. 892/2
grezzo/unpainted

Art. 10395/1
verniciato/painted

Art. 10393/9
con ganci e verniciato
with hook and painted

TORO - TAURUS



spess./thick. 3 mm
Ø 260 mm

Art. 892/1
grezzo/unpainted

Art. 10395/2
verniciato/painted

Art. 10393/1
con ganci e verniciato
with hook and painted

GEMELLI - GEMINI



spess./thick. 3 mm
Ø 260 mm

Art. 891/3
grezzo/unpainted

Art. 10395/3
verniciato/painted

Art. 10393/2
con ganci e verniciato
with hook and painted

CANCRO - CANCER



spess./thick. 3 mm
Ø 260 mm

Art. 891/6
grezzo/unpainted

Art. 10395/4
verniciato/painted

Art. 10393/3
con ganci e verniciato
with hook and painted

LEONE - LION



spess./thick. 3 mm
Ø 260 mm

Art. 892/4
grezzo/unpainted

Art. 10395/5
verniciato/painted

Art. 10393/4
con ganci e verniciato
with hook and painted

VERGINE - VIRGO



spess./thick. 3 mm
Ø 260 mm

Art. 892/5
grezzo/unpainted

Art. 10395/6
verniciato/painted

Art. 10393/5
con ganci e verniciato
with hook and painted

BILANCIA - LIBRA



spess./thick. 3 mm
Ø 260 mm

Art. 892/6
grezzo/unpainted

Art. 10395/7
verniciato/painted

Art. 10393/6
con ganci e verniciato
with hook and painted

SCORPIONE - SCORPIO



spess./thick. 3 mm
Ø 260 mm

Art. 892/3
grezzo/unpainted

Art. 10395/8
verniciato/painted

Art. 10393/7
con ganci e verniciato
with hook and painted

SAGITTARIO - SAGITTARIUS



spess./thick. 3 mm
Ø 260 mm

Art. 891/1
grezzo/unpainted

Art. 10395/9
verniciato/painted

Art. 10393/8
con ganci e verniciato
with hook and painted

CAPRICORNO - CAPRICORN



spess./thick. 3 mm
Ø 260 mm

Art. 891/2
grezzo unpainted

Art. 10395/10
verniciato/painted

Art. 10393/12
con ganci e verniciato
with hook and painted

ACQUARIO - AQUARIUS



spess./thick. 3 mm
Ø 260 mm

Art. 891/4
grezzo/unpainted

Art. 10395/11
verniciato/painted

Art. 10393/10
con ganci e verniciato
with hook and painted

PESCI - PISCES



spess./thick. 3 mm
Ø 260 mm

Art. 891/5
grezzo/unpainted

Art. 10395/12
verniciato/painted

Art. 10393/11
con ganci e verniciato
with hook and painted



spess./thick. 3 mm
Ø 260 mm

Art. 1538/1
grezzo/unpainted

Art. 1536/1
con ganci - grezzo
with hook - unpainted

Art. 1532/1
verniciato/painted

Art. 1530/1
con ganci e verniciato
with hook and painted



spess./thick. 3 mm
Ø 260 mm

Art. 1538/2
grezzo/unpainted

Art. 1536/2
con ganci - grezzo
with hook - unpainted

Art. 1532/2
verniciato/painted

Art. 1530/2
con ganci e verniciato
with hook and painted



spess./thick. 3 mm
Ø 260 mm

Art. 1538/3
grezzo/unpainted

Art. 1536/3
con ganci - grezzo
with hook - unpainted

Art. 1532/3
verniciato/painted

Art. 1530/3
con ganci e verniciato
with hook and painted



spess./thick. 3 mm
Ø 260 mm

Art. 1538/4
grezzo/unpainted

Art. 1536/4
con ganci - grezzo
with hook - unpainted

Art. 1532/4
verniciato/painted

Art. 1530/4
con ganci e verniciato
with hook and painted

Ø = diameter



spess./thick. 3 mm
Ø 260 mm

Art. 1538/5
grezzo/unpainted

Art. 1536/5
con ganci - grezzo
with hook - unpainted

Art. 1532/5
verniciato/painted

Art. 1530/5
con ganci e verniciato
with hook and painted



spess./thick. 3 mm
Ø 260 mm

Art. 1538/6
grezzo/unpainted

Art. 1536/6
con ganci - grezzo
with hook - unpainted

Art. 1532/6
verniciato/painted

Art. 1530/6
con ganci e verniciato
with hook and painted

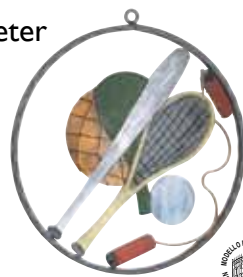

spess./thick. 3 mm
Ø 260 mm

Art. 1538/7
grezzo/unpainted

Art. 1536/7
con ganci - grezzo
with hook - unpainted

Art. 1532/7
verniciato/painted

Art. 1530/7
con ganci e verniciato
with hook and painted



spess./thick. 3 mm
Ø 260 mm

Art. 1538/8
grezzo/unpainted

Art. 1536/8
con ganci - grezzo
with hook - unpainted

Art. 1532/8
verniciato/painted

Art. 1530/8
con ganci e verniciato
with hook and painted



spess./thick. 3 mm
Ø 260 mm

Art. 1539/1
grezzo/unpainted

Art. 1537/1
con ganci - grezzo
with hook - unpainted

Art. 1533/1
verniciato/painted

Art. 1531/1
con ganci e verniciato
with hook and painted



spess./thick. 3 mm
Ø 260 mm

Art. 1539/2
grezzo/unpainted

Art. 1537/2
con ganci - grezzo
with hook - unpainted

Art. 1533/2
verniciato/painted

Art. 1531/2
con ganci e verniciato
with hook and painted



spess./thick. 3 mm
Ø 260 mm

Art. 1539/3
grezzo/unpainted

Art. 1537/3
con ganci - grezzo
with hook - unpainted

Art. 1533/3
verniciato/painted

Art. 1531/3
con ganci e verniciato
with hook and painted



spess./thick. 3 mm
Ø 260 mm

Art. 1539/4
grezzo/unpainted

Art. 1537/4
con ganci - grezzo
with hook - unpainted

Art. 1533/4
verniciato/painted

Art. 1531/4
con ganci e verniciato
with hook and painted



spess./thick. 3 mm
Ø 260 mm

Art. 1539/5
grezzo/unpainted

Art. 1537/5
con ganci - grezzo
with hook - unpainted

Art. 1533/5
verniciato/painted

Art. 1531/5
con ganci e verniciato
with hook and painted



spess./thick. 3 mm
Ø 260 mm

Art. 1539/6
grezzo/unpainted

Art. 1537/6
con ganci - grezzo
with hook - unpainted

Art. 1533/6
verniciato/painted

Art. 1531/6
con ganci e verniciato
with hook and painted



spess./thick. 3 mm
Ø 260 mm

Art. 1539/7
grezzo/unpainted

Art. 1537/7
con ganci - grezzo
with hook - unpainted

Art. 1533/7
verniciato/painted

Art. 1531/7
con ganci e verniciato
with hook and painted



spess./thick. 3 mm
Ø 260 mm

Art. 1539/8
grezzo/unpainted

Art. 1537/8
con ganci - grezzo
with hook - unpainted

Art. 1533/8
verniciato/painted

Art. 1531/8
con ganci e verniciato
with hook and painted



spess./thick. 3 mm
Ø 260 mm

Art. 1539/9
grezzo/unpainted

Art. 1537/9
con ganci - grezzo
with hook - unpainted

Art. 1533/9
verniciato/painted

Art. 1531/9
con ganci e verniciato
with hook and painted



spess./thick. 3 mm
Ø 260 mm

Art. 1539/10
grezzo/unpainted

Art. 1537/10
con ganci - grezzo
with hook - unpainted

Art. 1533/10
verniciato/painted

Art. 1531/10
con ganci e verniciato
with hook and painted

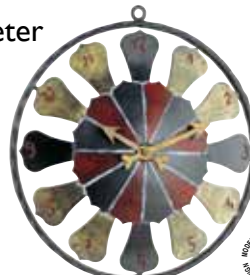

spess./thick. 3 mm
Ø 260 mm

Art. 1539/11
grezzo/unpainted

Art. 1537/11
con ganci - grezzo
with hook - unpainted

Art. 1533/11
verniciato/painted

Art. 1531/11
con ganci e verniciato
with hook and painted



spess./thick. 3 mm
Ø 260 mm

Art. 1539/12
grezzo/unpainted

Art. 1537/12
con ganci - grezzo
with hook - unpainted

Art. 1533/12
verniciato/painted

Art. 1531/12
con ganci e verniciato
with hook and painted

Ø = diameter



spess./thick. 3 mm
Ø 260 mm

Art. 1539/13
grezzo/unpainted

Art. 1537/13
con ganci - grezzo
with hook - unpainted

Art. 1533/13
verniciato/painted

Art. 1531/13
con ganci e verniciato
with hook and painted



spess./thick. 3 mm
Ø 260 mm

Art. 1539/14
grezzo/unpainted

Art. 1537/14
con ganci - grezzo
with hook - unpainted

Art. 1533/14
verniciato/painted

Art. 1531/14
con ganci e verniciato
with hook and painted



spess./thick. 3 mm
Ø 260 mm

Art. 1539/15
grezzo/unpainted

Art. 1537/15
con ganci - grezzo
with hook - unpainted

Art. 1533/15
verniciato/painted

Art. 1531/15
con ganci e verniciato
with hook and painted



spess./thick. 3 mm
Ø 260 mm

Art. 1539/16
grezzo/unpainted

Art. 1537/16
con ganci - grezzo
with hook - unpainted

Art. 1533/16
verniciato/painted

Art. 1531/16
con ganci e verniciato
with hook and painted



spess./thick. 3 mm
230 x 270 mm

Art. 1535/1
grezzo/unpainted

Art. 1534/1
verniciato/painted



spess./thick. 3 mm
200 x 230 mm

Art. 1535/2
grezzo/unpainted

Art. 1534/2
verniciato/painted



spess./thick. 3 mm
200 x 235 mm

Art. 1535/3
grezzo/unpainted

Art. 1534/3
verniciato/painted



spess./thick. 3 mm
240 x 255 mm

Art. 1535/4
grezzo/unpainted

Art. 1534/4
verniciato/painted



spess./thick. 3 mm
245 x 235 mm

Art. 1535/5
grezzo/unpainted

Art. 1534/5
verniciato/painted



spess./thick. 3 mm
190 x 220 mm

Art. 1535/6
grezzo/unpainted

Art. 1534/6
verniciato/painted



spess./thick. 3 mm
190 x 250 mm

Art. 1535/7
grezzo/unpainted

Art. 1534/7
verniciato/painted



spess./thick. 3 mm
210 x 230 mm

Art. 1535/8
grezzo/unpainted

Art. 1534/8
verniciato/painted



spess./thick. 3 mm
185 x 240 mm

Art. 1535/9
grezzo/unpainted

Art. 1534/9
verniciato/painted



spess./thick. 3 mm
210 x 250 mm

Art. 1535/10
grezzo/unpainted

Art. 1534/10
verniciato/painted



spess./thick. 3 mm
240 x 220 mm

Art. 1535/11
grezzo/unpainted

Art. 1534/11
verniciato/painted



spess./thick. 3 mm
240 x 170 mm

Art. 1535/12
grezzo/unpainted

Art. 1534/12
verniciato/painted



spess./thick. 3 mm
180 x 230 mm

Art. 1535/13
grezzo/unpainted

Art. 1534/13
verniciato/painted



spess./thick. 3 mm
215 x 190 mm

Art. 1535/14
grezzo/unpainted

Art. 1534/14
verniciato/painted



spess./thick. 3 mm
245 x 240 mm

Art. 1535/15
grezzo/unpainted

Art. 1534/15
verniciato/painted



spess./thick. 3 mm
205 x 245 mm

Art. 1535/16
grezzo/unpainted

Art. 1534/16
verniciato/painted





spess./thick. 3 mm
210 x 220 mm

Art. 1535/17
grezzo/unpainted

Art. 1534/17
verniciato/painted



spess./thick. 3 mm
190 x 240 mm

Art. 1535/18
grezzo/unpainted

Art. 1534/18
verniciato/painted



spess./thick. 3 mm
Ø 245 mm

Art. 1535/19
grezzo/unpainted

Art. 1534/19
verniciato/painted



spess./thick. 3 mm
230 x 250 mm

Art. 1535/20
grezzo/unpainted

Art. 1534/20
verniciato/painted



spess./thick. 3 mm
240 x 140 mm

Art. 1535/21
grezzo/unpainted

Art. 1534/21
verniciato/painted



spess./thick. 3 mm
230 x 230 mm

Art. 1535/22
grezzo/unpainted

Art. 1534/22
verniciato/painted



spess./thick. 3 mm
160 x 250 mm

Art. 1535/23
grezzo/unpainted

Art. 1534/23
verniciato/painted



spess./thick. 3 mm
160 x 250 mm

Art. 1535/24
grezzo/unpainted

Art. 1534/24
verniciato/painted



Art. 156/A/7
5 x 5 mm
Ø 35 mm

Art. 156/A/8
5 x 5 mm
Ø 40 mm

Art. 156/A/9
4,5 x 4,5 mm
19 x 50 mm

Art. 156/A/10
5 x 5 mm
15 x 35 mm

Art. 156/A/11
3,5 x 3,5 mm
12 x 40 mm

Art. 156/A/12
3,8 x 3,8 mm
9 x 28 mm

Le misure si riferiscono all'interno della maglia / Size refer to the inside width of the link
LUNGHEZZA delle CATENE = 10.000 mm (10 mt.) / CHAIN LONG = 10.000 mm (10 mt.)



Art. 6318/I - L 3250 mm - H max 2650 mm



Art. 6340/I - L 3240 mm - H max 2660 mm





Art. 6346/I - L 3260 mm - H max 2855 mm



Art. 6344/I - L 3240 mm - H max 2500 mm





Art. 6322/I - L 3240 mm - H max 2490 mm



Art. 6324/I - L 3240 mm - H max 2500 mm





Art. 6320/I - L 1152 mm - H max 1960 mm



Art. 6321/I - L 1120 mm - H max 2490 mm



Art. 6326/I - L 1350 mm - H max 2380 mm



Art. 6327/I - L 1240 mm - H max 2528 mm

ELEMENTI VARI - VARIOUS ELEMENTS



Art. 6343/I - L 1350 mm - H max 2380 mm



Art. 6342/I - L 1050 mm - H max 2300 mm



Art. 6348/I - L 1240 mm - H max 2460 mm



Art. 6349/I - L 1050 mm - H max 2585 mm



L 1500 mm

Art. 6352/1

H 800 mm

Art. 6352/2

H 1000 mm



L 1500 mm

Art. 6353/1

H 800 mm

Art. 6353/2

H 1000 mm



L 1500 mm

Art. 6354/1

H 800 mm

Art. 6354/2

H 1000 mm





L 1500 mm

Art. 6356/1

H 800 mm

Art. 6356/2

H 1000 mm



L 1500 mm

Art. 6355/1

H 800 mm

Art. 6355/2

H 1000 mm

MONTANTI per PANNELLI MODULARI per RECINZIONI
NEWEL POSTS for MODULAR PANELS for FENCES



Per Pannelli/for panels H 800 mm

Art. 6356/3

H 1000 mm



Per Pannelli/for panels H 800 mm

Art. 6355/3

H 1000 mm



Per Pannelli/for panels H 800 mm

Art. 6352/3

H 1000 mm

Per Pannelli/for panels H 1000 mm

Art. 6356/4

H 1200 mm

Per Pannelli/for panels H 1000 mm

Art. 6355/4

H 1200 mm

Per Pannelli/for panels H 1000 mm

Art. 6352/4

H 1200 mm



Tondo Ø 22 mm a corteccia
Round iron dia 22 mm three effect

Tubo dia 22 mm - liscio
Round Tube iron dia 22 mm



L 1300 mm	Art. 889/1	Art. 889/2
L 1800 mm	Art. 889/3	Art. 889/4
L 2300 mm	Art. 889/5	Art. 889/6



Tondo Ø 22 mm a corteccia
Round iron dia 22 mm three effect

Tubo dia 22 mm - liscio
Round Tube iron dia 22 mm



L 1270 mm	Art. 889/8	Art. 889/7
L 1770 mm	Art. 889/10	Art. 889/9
L 2270 mm	Art. 889/12	Art. 889/11



Tondo Ø 22 mm a corteccia
Round iron dia 22 mm three effect

Tubo dia 22 mm - liscio
Round Tube iron dia 22 mm



L 1210 mm	Art. 889/13	Art. 889/14
L 1710 mm	Art. 889/15	Art. 889/16
L 2210 mm	Art. 889/17	Art. 889/18



Tondo Ø 22 mm a corteccia
Round iron dia 22 mm three effect

Tubo dia 22 mm - liscio
Round Tube iron dia 22 mm



L 1210 mm	Art. 889/20	Art. 889/19
L 1710 mm	Art. 889/22	Art. 889/21
L 2210 mm	Art. 889/24	Art. 889/23



Tondo Ø 22 mm a corteccia
Round iron dia 22 mm three effect

Tubo dia 22 mm - liscio
Round Tube iron dia 22 mm



L 1190 mm	Art. 889/25	Art. 889/26
L 1690 mm	Art. 889/27	Art. 889/28
L 2190 mm	Art. 889/29	Art. 889/30



Tondo Ø 22 mm a corteccia
Round iron dia 22 mm three effect

Tubo dia 22 mm - liscio
Round Tube iron dia 22 mm



L 1140 mm	Art. 889/32	Art. 889/31
L 1640 mm	Art. 889/34	Art. 889/33
L 2140 mm	Art. 889/36	Art. 889/35



Tondo Ø 22 mm a corteccia
Round iron dia 22 mm three effect

Tubo dia 22 mm - liscio
Round Tube iron dia 22 mm



L 1080 mm	Art. 889/37	Art. 889/38
L 1580 mm	Art. 889/39	Art. 889/40
L 2080 mm	Art. 889/41	Art. 889/42



Art. 885/1
 \square 20 x 4 mm
 155 x 120 mm



Art. 885/3
 \square 20 x 4 mm
 210 x 190 mm



Art. 885/4
 \square 25 x 3 mm
 230 x 180 mm



Art. 885/6
 \square 18 x 5 mm
 205 x 235 mm

Art. 885/2
 \square 20 x 4 mm
 205 x 150 mm

Art. 885/5
 \square 25 x 3 mm
 165 x 295 mm



Art. 885/7
 \square 20 x 8 mm
 310 x 240 mm



Art. 886/3
 \square 20 x 8 mm
 290 x 235 mm



Art. 886/1
 \square 20 x 4 mm
 245 x 220 mm



Art. 886/2
 \square 20 x 4 mm
 215 x 216 mm



Art. 886/4
 \square 12 x 12 mm
 215 x 255 mm

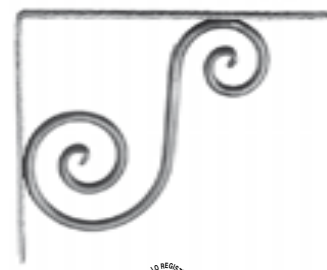

Art. 885/8
 \square 20 x 4 mm
 150 x 200 mm



Art. 1470/7
 \square 75 x 3 mm
 230 x 300 mm



Art. 1470/6
 \square 75 x 3 mm
 240 x 300 mm



Art. 1470/5
 \square 75 x 3 mm
 290 x 300 mm



Art. 1470/4
 \square 75 x 3 mm
 340 x 520 mm



Art. 1470/3
 \square 75 x 3 mm
 330 x 520 mm



Art. 1469/1
 \square 25 x 6 mm
 440 x 260 mm
 fessura/slit 6 mm



ARTEFERRO

Art. 1470/1

☐ 16 x 8 mm
930 x 830 mm
Piatto di supporto
Support section
☐ 40 x 6 mm

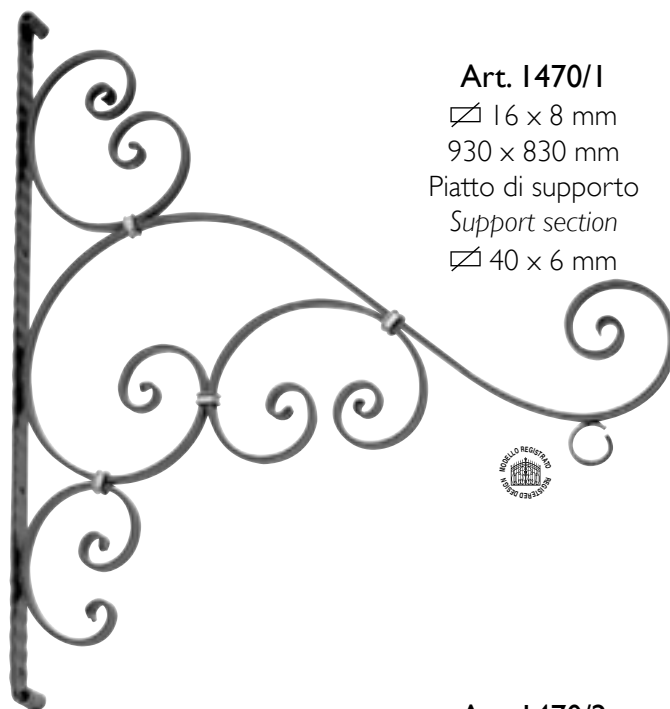

Art. 1470/2

☐ 16 x 8 mm
620 x 760 mm
Piatto di supporto
Support section
☐ 40 x 6 mm



Art. 200/2
470 x 520 mm

Portata
Carry well
kg 100 circa



☐ 12 x 12 mm
450 x 510 mm

Art. 902/6
grezzo/unpainted
Art. 10333/1
verniciato/unpainted



☐ 14 x 14 mm
450 x 510 mm

Art. 902/4
grezzo/unpainted
Art. 10520/1
verniciato/unpainted



Art. 170/8
450 x 35 mm

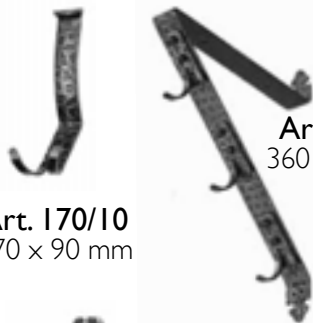

Art. 170/9
360 x 35 mm

Art. 170/10
170 x 90 mm



Art. 170/11
80 x 40 mm



Art. 170/12
170 x 105 mm



Art. 838/6
180 x 100 mm



Art. 838/7
130 x 110 mm



Art. 838/5
240 x 120 mm



Art. 168/1
300 x 60 mm



Portacandela
Candle Holder

Art. 10437/1
H 190 mm
base Ø 90 mm

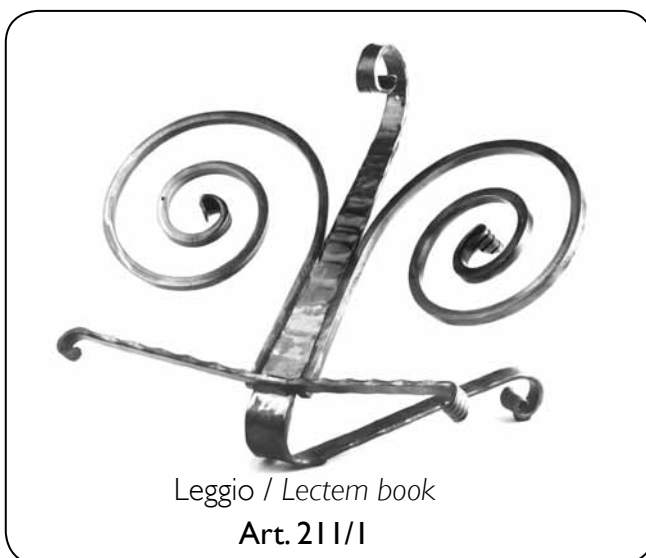

Leggio / Lectem book

Art. 211/1



Art. 1540/6
110 x 105 mm
spess./thick. 3 mm



110 x 105 mm
spess./thick. 3 mm

Art. 1540/7
per n. 2 barre/bars
12 x 6 mm

Art. 1540/8
per n. 3 barre/bars
12 x 6 mm

Art. 1540/9
per n. 4 barre/bars
12 x 6 mm

Art. 10539/1
H 1250 mm
tubo-tube Ø 50 mm



Art. 1540/1
H 530 mm
tubo-tube Ø50 mm

20 x 20 mm
base Ø 35 mm

Art. 888/2
H 610 mm

Art. 888/3
H 365 mm



Art. 10455/1
H 600 mm
L 1020 mm
P 530 mm



Art. 213/2
200 x 790 mm

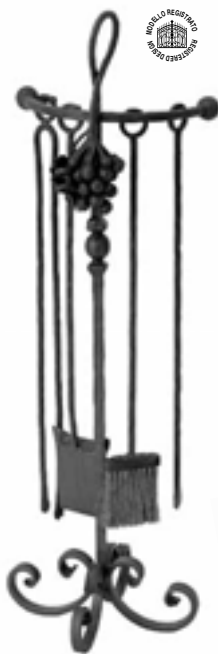

Art. 10472/1
810 x 260 mm



Art. 213/3
230 x 490 x 250 mm



Art. 10473/1
380 x 490 mm



Art. 213/4
200 x 510 x 400 mm



Art. 10473/2
520 x 610 mm



Art. 213/1
360 x 430 mm



Art. 10472/2
530 x 420 x 260 mm



Art. 10474/1
550 x 900 mm



Art. 10475/1
390 x 510 x 410 mm



Art. 10477/2
620 x 420 x 200 mm



Art. 10475/2
480 x 520 x 310 mm



Art. 10477/1
480 x 380 x 360 mm



Art. 1471/3006/0

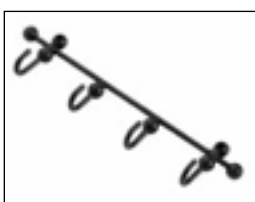

1471/3006/1

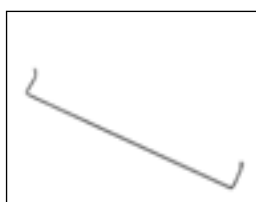

1471/3006/2

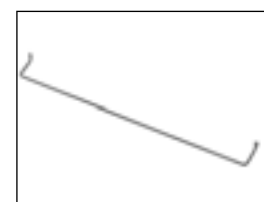

1471/3006/3

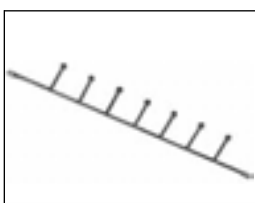

1471/3006/4

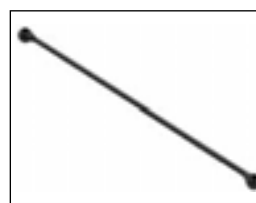

1471/3006/5



1471/3006/6



1471/3006/7



1471/3006/8

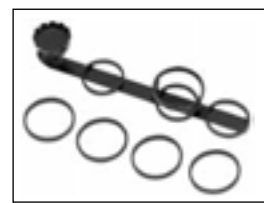

1471/3006/9

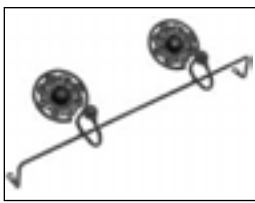

1471/3006/10

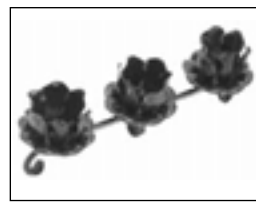

1471/3006/11

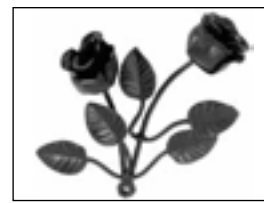

1471/3006/12



1471/3006/13

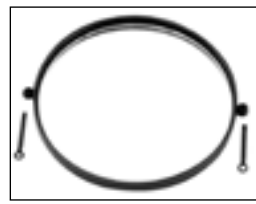

1471/3006/14



1471/3006/15

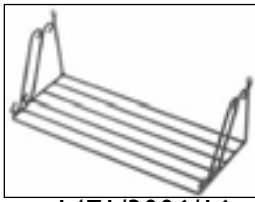

1471/3006/16

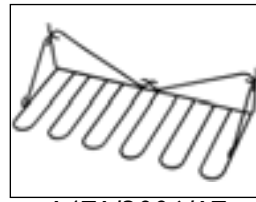

1471/3006/17

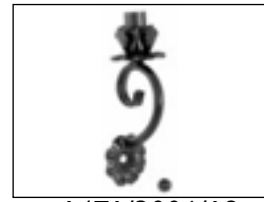

1471/3006/18



1471/3006/19

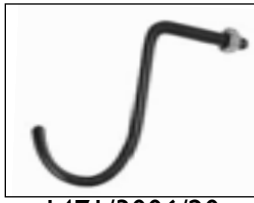

1471/3006/20



1471/3006/21



1471/3006/22

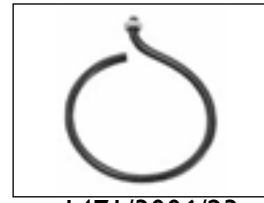

1471/3006/23



1471/3006/24



1471/3006/25



1471/3006/26



1471/3006/27



1471/3006/28

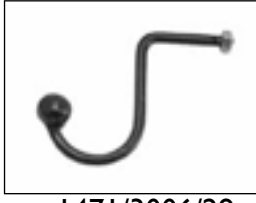

1471/3006/29

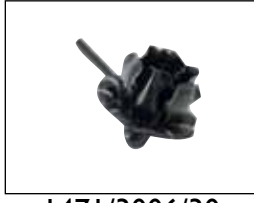

1471/3006/30

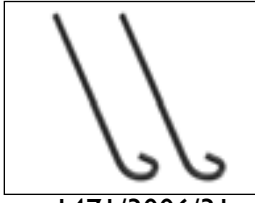

1471/3006/31



1471/3006/32



1471/3006/33



ELEMENTI VARI - VARIOUS ELEMENTS

COMPENDIUM 2010

Art. 181/10
285 x 105 mm
spessore/thickness 30 mm

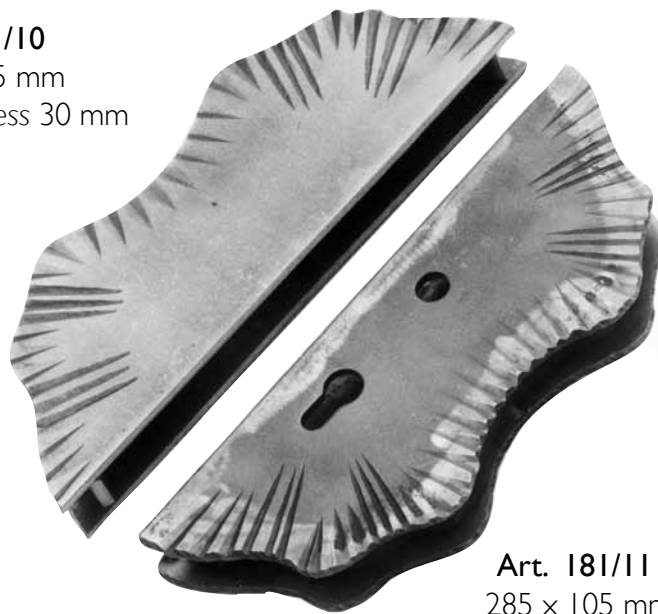

Art. 181/12

Art. 181/11
285 x 105 mm
spessore / thickness 30 mm



Art. 181/15



Art. 169/11
70 x 125 mm
(coppia - couple)

maniglia completa di rosetta
Door handle complete with rosette



ARTEFERRO



Art. 841/5
210 x 290 mm
spessore/thickness 4 mm

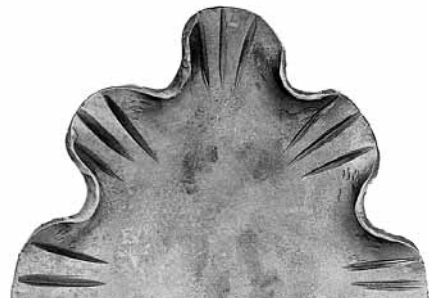

Art. 841/6
200 x 150 mm
spessore/thickness 4 mm



Art. 841/1
275 x 160 mm
sp./thickness 3 mm



Art. 841/2
275 x 160 mm
sp./thickness 3 mm



Art. 841/3
275 x 160 mm
sp./thickness 3 mm



Art. 841/4
275 x 160 mm
sp./thickness 3 mm



Art. 842/1
275 x 190 mm
sp./thickness 3 mm



Art. 842/2
275 x 190 mm
sp./thickness 3 mm



Art. 842/3
275 x 190 mm
sp./thickness 3 mm



Art. 842/4
275 x 190 mm
sp./thickness 3 mm



Art. 842/5
290 x 175 mm
sp./thickness 3 mm



Art. 842/6
290 x 175 mm
sp./thickness 3 mm



Art. 842/7
290 x 175 mm
sp./thickness 3 mm



Art. 842/8
290 x 175 mm
sp./thickness 3 mm



Art. 169/12
70 x 135 mm
(coppia - couple)



Art. 169/15
40 x 110 mm
(coppia - couple)

maniglia completa di rosetta
Door handle complete with rosette



Art. 169/14
70 x 135 mm
(coppia - couple)

maniglia completa di rosetta
Door handle complete with rosette



Art. 835/6
Rosetta/Rosette Ø 30 mm



Art. 169/13
80 x 140 mm
(coppia - couple)



Art. 168/5
265 x 48 mm
(coppia - couple)



Art. 168/4
250 x 38 mm
(coppia - couple)



Art. 168/6
250 x 56 mm
(coppia - couple)



Art. 168/3
265 x 48 mm
(coppia - couple)



Art. 833/4
280 x 60 mm
(coppia - couple)



Art. 836/1
250 x 50 mm
(coppia - couple)

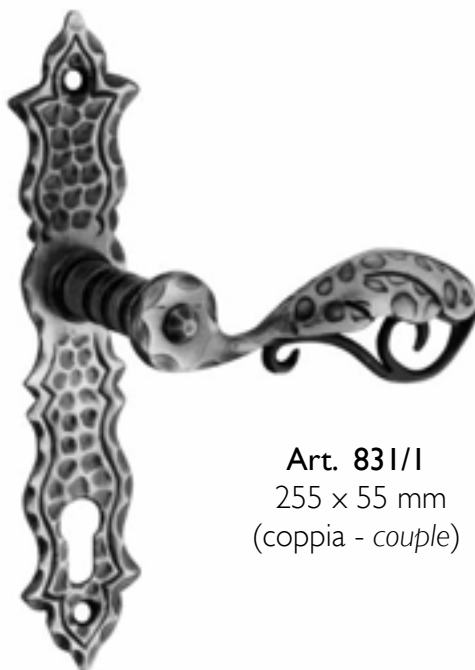

Art. 831/1
255 x 55 mm
(coppia - couple)



ARTEFERRO



Art. 835/8
90 x 50 mm



Art. 835/7
90 x 50 mm



Art. 835/9
100 x 40 mm

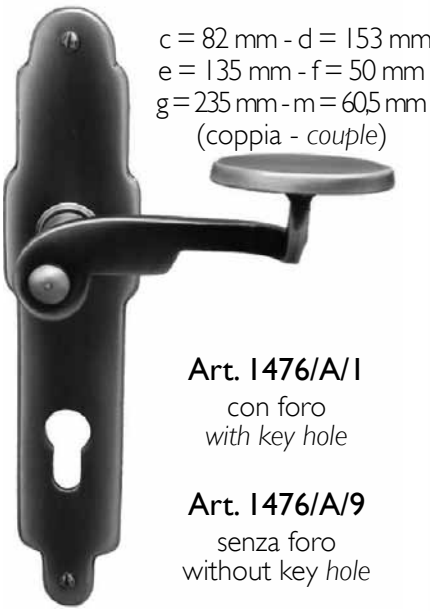

c = 82 mm - d = 153 mm
e = 135 mm - f = 50 mm
g = 235 mm - m = 605 mm
(coppia - couple)

Art. 1476/A/1
con foro
with key hole

Art. 1476/A/9
senza foro
without key hole



c = 85 mm - d = 155 mm
e = 140 mm - f = 57 mm
g = 240 mm - m = 605 mm
(coppia - couple)

Art. 1476/A/2
con foro
with key hole

Art. 1476/A/10
senza foro
without key hole



c = 80 mm - d = 150 mm
e = 140 mm - f = 60 mm
g = 230 mm - m = 605 mm
(coppia - couple)

Art. 1476/A/3
con foro
with key hole

Art. 1476/A/11
senza foro
without key hole

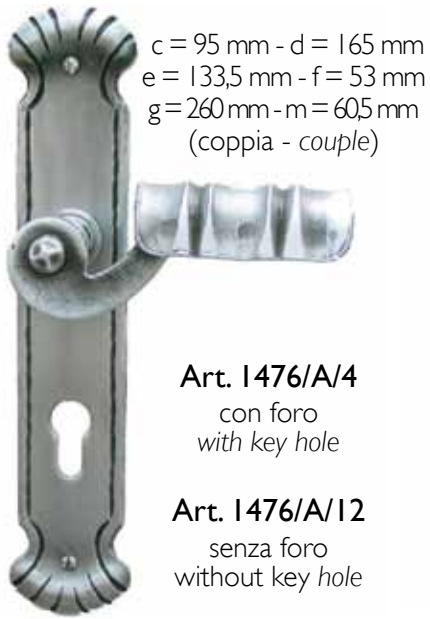

c = 95 mm - d = 165 mm
e = 133,5 mm - f = 53 mm
g = 260 mm - m = 605 mm
(coppia - couple)

Art. 1476/A/4
con foro
with key hole

Art. 1476/A/12
senza foro
without key hole

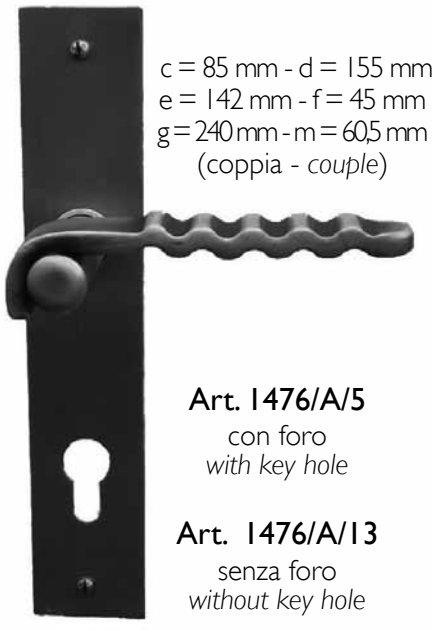

c = 85 mm - d = 155 mm
e = 142 mm - f = 45 mm
g = 240 mm - m = 605 mm
(coppia - couple)

Art. 1476/A/5
con foro
with key hole

Art. 1476/A/13
senza foro
without key hole



c = 80 mm - d = 150 mm
e = 142 mm - f = 50 mm
g = 230 mm - m = 605 mm
(coppia - couple)

Art. 1476/A/6
con foro
with key hole

Art. 1476/A/14
senza foro
without key hole



c = 80 mm - d = 157 mm
e = 150 mm - f = 58 mm
g = 237 mm - m = 605 mm
(coppia - couple)

Art. 1476/A/7
con foro
with key hole

Art. 1476/A/15
senza foro
without key hole

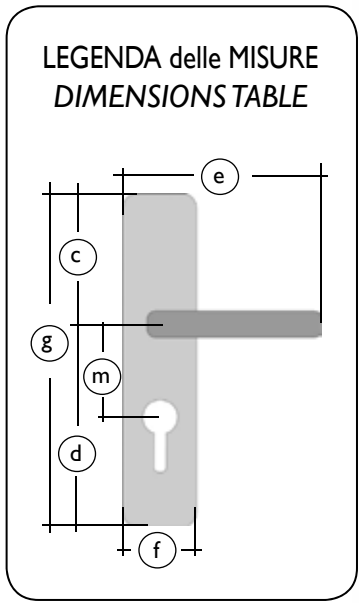

c = 125 mm - d = 180 mm
e = 160 mm - f = 55 mm
g = 305 mm - m = 605 mm
(coppia - couple)

Art. 1476/A/8
con foro
with key hole



Art. 1476/1
 $a = 129 - b = 100$ mm
 (coppia - couple)

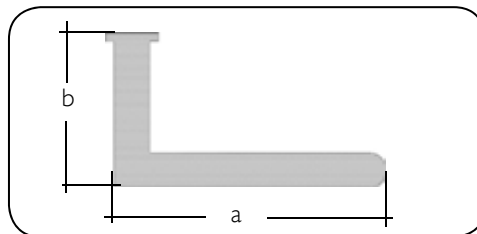

Art. 1476/2
 $a = 130 - b = 72$ mm
 (coppia - couple)

PLACCHE per IMPUGNATURA
 ROSETTES for HANDLES

Art. 1476/9
 $\varnothing 52,5$ mm
 sp./thick. 3 mm



Art. 1476/10
 $\varnothing 53,5$
 $h 63,2$ mm
 sp./thick. 3 mm



Art. 1476/3
 $a = 124 - b = 69$ mm
 (coppia - couple)



Art. 1476/4
 $a = 130 - b = 79$ mm
 (coppia - couple)

PLACCHE per SERRATURA
 ROSETTES for LOCKS

Art. 1476/11
 $\varnothing 52,5$ mm
 sp./thick. 3 mm



Art. 1476/12
 $\varnothing 52,5$ mm
 sp./thick. 3 mm



Art. 1476/13
 $\varnothing 53,5$ mm
 $h 63,2$ mm
 sp./thick. 3 mm



Art. 1476/14
 $\varnothing 53,5$ mm
 $h 63,2$ mm
 sp./thick. 3 mm



Art. 1476/5
 $a = 135 - b = 78$ mm
 (coppia - couple)



Art. 1476/6
 $a = 114 - b = 95$ mm
 (coppia - couple)



Art. 1476/7
 $a = 133 - b = 75$ mm
 (coppia - couple)



Art. 1476/8
 $a = 149 - b = 100$ mm
 (coppia - couple)

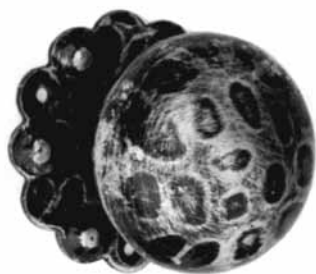

Art. 169/1
 Ø 68 mm
 girevole - rotating

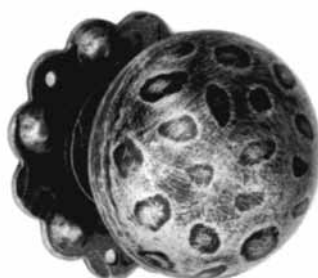

Art. 169/2
 Ø 60 mm
 girevole - rotating



Art. 169/3
 Ø 60 mm
 girevole - rotating

Ø = diameter



Art. 834/1
 Ø 67 mm
 H 75 mm
 girevole - rotating



Art. 834/2
 Ø 67 mm



Art. 838/1
 57 x 57 mm
 H 70 mm
 girevole - rotating



Art. 838/2
 57 x 57 mm
 H 70 mm
 fisso - fixed

Art. 838/3
 60 x 60 mm
 H 45 mm
 fisso - fixed



Art. 838/4
 75 x 75 mm
 H 60 mm
 fisso - fixed



Art. 170/1
Ø 65 mm



Art. 170/2
Ø 65 mm



Art. 170/3
Ø 50 mm



Art. 170/5
Ø 50 mm



Art. 839/5
85 x 35 mm
sp./thick. 2 mm



Art. 839/6
85 x 35 mm
sp./thick. 2 mm



Art. 839/7
85 x 35 mm
sp./thick. 2 mm
foro/hole Ø 14 mm



Art. 839/8
70 x 35 mm
sp./thick. 2 mm



Art. 839/9
100 x 40 mm
sp./thick. 2 mm



Art. 839/10
100 x 40 mm
sp./thick. 2 mm
foro/hole Ø 14 mm

Ø = diameter



Art. 169/6
250 x 56 mm



Art. 169/7
250 x 38 mm



Art. 169/8
265 x 48 mm



Art. 169/9
265 x 48 mm

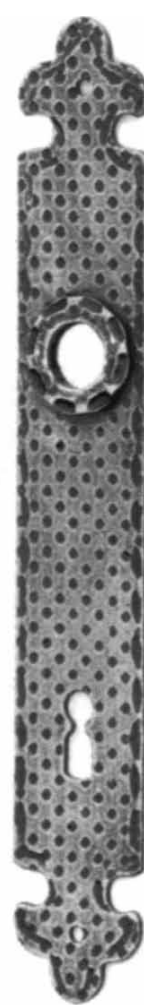

Art. 169/10
250 x 38 mm



Art. 832/5
255 x 50 mm



Art. 832/1
265 x 60 mm



Art. 832/2
220 x 45 mm



Art. 832/3
295 x 60 mm



Art. 832/4
280 x 60 mm
fisso / fixed



Art. 832/6
265 x 75 mm



Art. 832/7
265 x 60 mm



Art. 832/8
255 x 65 mm



Art. 833/7
240 x 50 mm



Art. 833/5
255 x 50 mm



Art. 833/8
250 x 53 mm



Art. 833/9
265 x 50 mm



Art. 836/2
275 x 60 mm



Art. 836/3
255 x 65 mm



Art. 836/5
225 x 60 mm



Art. 836/6
270 x 40 mm



Art. 836/7
280 x 40 mm



Art. 836/8
255 x 50 mm



Art. 836/9
255 x 50 mm



Art. 1475/1
250 x 40 mm



Art. 1475/5
265 x 47 mm

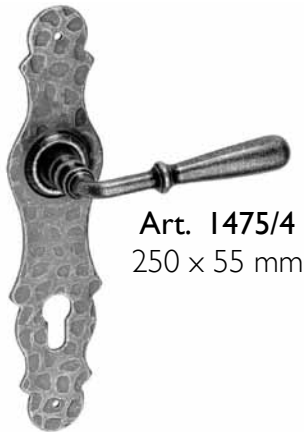

Art. 1475/4
250 x 55 mm

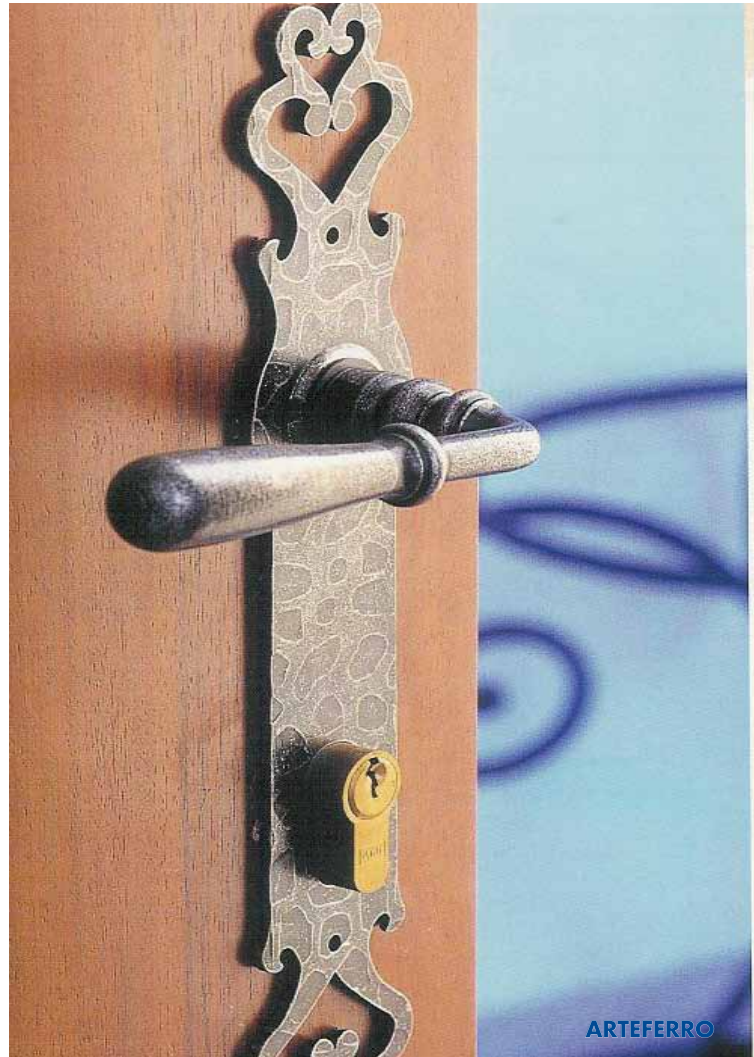

Art. 1475/6
220 x 50 mm



Art. 168/2
250 x 56 mm



Art. 1475/2
270 x 55 mm



Art. 1475/3
250 x 40 mm



Art. 833/6
240 x 260 mm



Art. 834/3
265 x 80 mm



Art. 836/4
275 x 60 mm
girevole / rotating

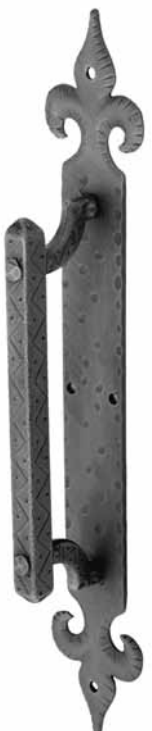

Art. 839/4
250 x 70 mm
□ 18 mm



Art. 170/6
310 x 60 mm

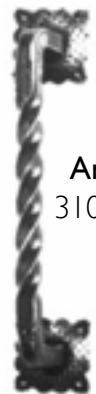

Art. 839/1
H 300 mm
Ø 32 mm
Rosetta/Rosette
Ø 80 mm



Art. 839/2
H 200 mm
Ø 25 mm
Rosetta/Rosette
Ø 60 mm



Art. 1474/3
315 x 40 mm



Art. 1474/5
Ø 70 mm
Ø 8MA foro filetto
dia 8MA threaded hole

Ø = diameter

Art. 839/3
480 x 80 mm
□ 18 mm

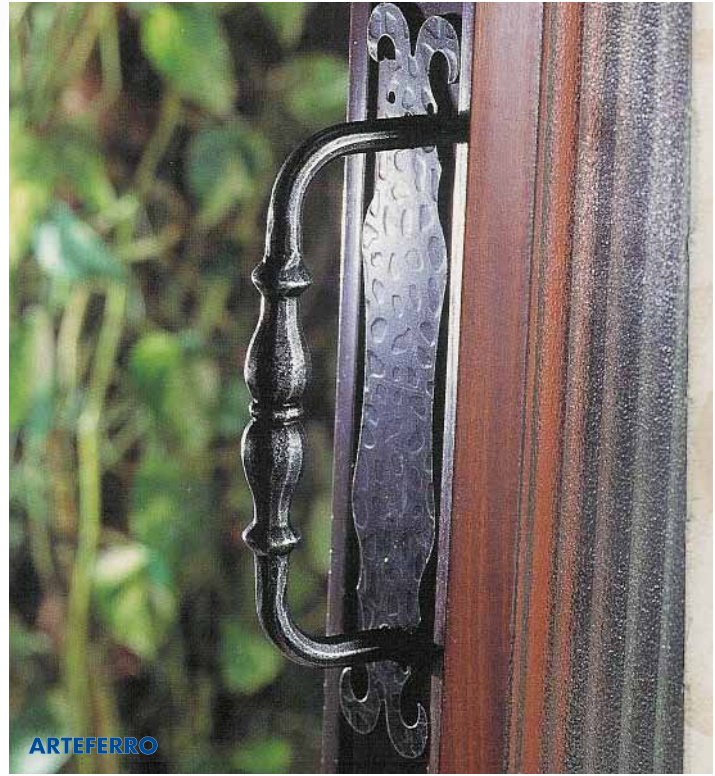

ARTEFERRO

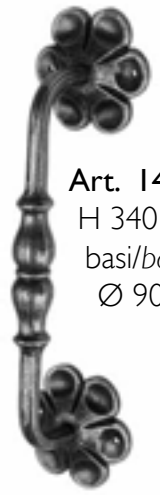

Art. 1474/2
H 340 mm
basi/bases
Ø 90 mm



Art. 1474/1
270 x 55 mm



Art. 833/3
77 x 35 mm



Art. 833/2
Ø 53 mm



Art. 833/1
58 x 58 mm



Art. 1475/7
37 x 75 mm



Art. 835/1
200 x 40 mm



Art. 835/2
160 x 55 mm



Art. 835/3
150 x 45 mm



Art. 835/4
140 x 33 mm



Art. 835/5
190 x 35 mm



Art. 170/7
170 x 105 mm



Art. 837/2
Ø 150 mm
rosetta/rosette
Ø 80 mm



Art. 1474/4
Ø 120 mm
base Ø 90 mm



Art. 837/1
Ø 110 mm
rosetta/rosette
Ø 95 mm



Art. 170/A/6
90 x 33 mm



Art. 170/A/4
90 x 38 mm



Art. 170/A/5
49 x 43 mm



Art. 170/A/10
49 x 43 mm



Art. 837/3
Ø 100 mm
rosetta/rosette
Ø 60 mm



Art. 170/A/8
58 x 27 mm



Art. 170/A/11
58 x 27 mm



Art. 170/A/2
68 x 125 mm



Art. 170/A/7
48 x 48 mm



Art. 170/A/9
48 x 48 mm



Art. 170/A/1
31 x 121 mm



Art. 170/A/3
92 x 55 mm



Art. 837/4
H 145 mm
60 x 2 mm



Art. 837/9
H 145 mm
110 x 2 mm



Art. 837/7
H 95 mm
70 x 2 mm



Art. 170/B/1
45 x 190 mm



Art. 170/B/2
30 x 150 mm



Art. 170/B/3
30 x 105 mm



Art. 170/B/5
81 x 137 mm



Art. 837/5
H 260 mm
55 x 2 mm



Art. 837/10
H 160 mm
120 x 2 mm



Art. 837/8
H 100 mm
70 x 2 mm



Art. 840/4
30 x 160 mm



Art. 840/5
30 x 200 mm



Art. 840/6
50 x 150 mm



Art. 837/6
165 x 70 mm
Ø 15 mm



Art. 169/4
H 250 mm
L 40 mm



Art. 169/5



Art. 840/1
65 x 300 mm



Art. 840/2
65 x 350 mm



Art. 840/3
65 x 400 mm

Ø = diameter





Art. 170/B/4
 Ø 14 mm
 100 x 52 mm
 filetto/threaded
 8 mm



Art. 830/1
 Ø 22 mm
 H 100 mm
 filetto/threaded
 14MA mm



Art. 830/2
 Ø 22 mm
 H 100 mm
 filetto/threaded
 14MA mm



Art. 830/3
 filetto / threaded
 20MA mm
Art. 830/4
 filetto / threaded
 24MA mm



Art. 182/1
 60 x 100 mm
Art. 182/2
 60 x 280 mm

CARDINE a SALDARE
 HINGE for WELDING to POST

CARDINE a MURO
 HINGE for BUILDING into WALL

CARDINE PASSANTE
 HINGE to FASTEN TROUGH POST

CARDINE a REGOLAZIONE ORTOGONALE
 RIGHT-ANGLE ADJUSTMENT HINGE



Art. 164/1
 filetto/threaded
 18MA mm



Art. 164/3
 filetto/threaded
 18MA mm



Art. 164/5
 filetto/threaded
 18MA mm



Art. 830/19
 filetto / thread
 18MA mm

Art. 164/2
 filetto/threaded
 22MA mm

Art. 164/4
 filetto/threaded
 22MA threaded

Art. 164/6
 filetto/threaded
 22MA mm

Art. 830/20
 filetto / threaded
 22MA mm

Art. 830/17
 filetto/threaded
 27MA mm

Art. 830/18
 filetto/threaded
 27MA mm

Art. 830/21
 filetto / threaded
 27MA mm



LUCIDO - POLISHED

Art. 830/5
 H 89 mm - Ø 20 mm

Art. 830/6
 H 89 mm - Ø 23 mm

Art. 830/7
 H 89 mm - Ø 28 mm

ZINCATO - ZINC PLATED

Art. 830/8
 H 89 mm - Ø 20 mm

Art. 830/9
 H 89 mm - Ø 23 mm

Art. 830/10
 H 89 mm - Ø 28 mm



con CARDINE
 with HINGE
 18MA

PERNO
 PIVOT

PIASTRA
 PLATE

Art. 164/11 **Art. 164/12**

con CARDINE
 with HINGE
 22MA

Art. 164/13 **Art. 164/14**

PIASTRA
 PLATE

con CARDINE
 with HINGE
 18MA

Art. 164/9

con CARDINE
 with HINGE
 22MA

Art. 164/10



LUCIDO - POLISHED

Art. 830/11
 H 15 mm - L 60 mm

Art. 830/12
 H 20 mm - L 70 mm

Art. 830/13
 H 20 mm - L 80 mm

ZINCATO - ZINC PLATED

Art. 830/14
 H 15 mm - L 60 mm

Art. 830/15
 H 20 mm - L 70 mm

Art. 830/16
 H 20 mm - L 80 mm

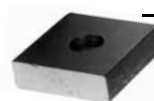

CARDINI CERTIFICATI PER PORTATE ELEVATE - HINGES CERTIFIED FOR HIGH CAPACITY



Art. 181/13
 Ø 38 mm
 H 230 mm
 filetto/threaded
 22MA mm

Art. 181/14
 Ø 32 mm
 H 175 mm
 filetto/threaded
 18MA mm

PERNO
 PIVOT



con CARDINE
 with HINGE
 18MA
Art. 164/7
 da abbinare con
 to be coupled with
 art. 164/9

con CARDINE
 with HINGE
 22MA
Art. 164/8
 da abbinare con
 to be coupled with
 art. 164/10



PRODOTTI CERTIFICATI CE
 LA CERTIFICAZIONE E IL RAPPORTO DEI TEST
 SONO DISPONIBILI SUL SITO
WWW.ARTEFERRO.COM

CE CERTIFIED PRODUCTS
 CERTIFICATION AND TESTED AVAILABLE AT
WWW.ARTEFERRO.COM



	Lt 0,75	Lt 2,50
NERO Forgia Forge BLACK	227/1	227/2
GRAFITE GRAPHITE Gray	227/3	227/4
BIANCO Antico Antique WHITE	227/33	227/34
TESTA di MORO Dark BROWN	227/35	227/36
VERDE Vagone Dark GREEN	227/37	227/38
ROSSO Inglese English RED	227/39	227/40
GRIGIO Perla Pearl GREY	227/41	227/42
GRIGIO Argento Silver GREY	227/43	227/16
GRIGIO Chiaro Light GRAY	227/44	227/18
GRIGIO Nero Black GRAY	227/45	227/20
GRIGIO Scuro Dark GRAY	227/46	227/22
BRONZO BRONZE	227/47	227/24
Vernice TRASPARENTE TRASPARENT Vernish	227/48	227/49
RUGGINE Trasparente RUST COLOUR Coating	227/53	227/54
VERDE Mobili Ind.i.a.'s Furniture GREEN GRAY	227/55	227/56

	Lt 0,25	
Patina ORO GOLD Patina	227/29	
Patina RAME COPPER Patina	227/30	
Patina VERDE GREEN Patina	227/31	
Patina ARGENTO SILVER Patina	227/32	
Patina VERDE RAME Opaco VERDIGRIS MAT Patina	227/50	
Patina ORO Pallido Pale GOLD Patina	227/51	
Patina ORO Antico Antique GOLD Patina	227/52	
RUGGINE Trasparente RUST COLOUR Coating	227/53	
VERDE Mobili Ind.i.a.'s Furniture GREEN GRAY	227/44	
	Lt 1,00	Lt 5,00
DILUENTE Sintetico THINNER	227/27	227/28
DILUENTE Nitro Nitro THINNER	227/57	227/58



GOLA a "V"
"V" GROOVE

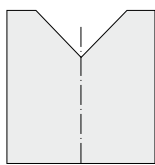

SERIE LEGGERA - n. 1 CUSCINETTO
LIGHT MODEL with nr. 1 BEARING

Cod. art. Art. no.	Ø/dia	SPESSORE WIDTH	PORTATA CAPACITY
844/1	50 mm	20 mm	200 Kg
844/2	60 mm	20 mm	300 Kg
844/3	70 mm	20 mm	300 Kg
844/34	75 mm	20 mm	300 Kg
844/4	80 mm	20 mm	300 Kg
844/5	90 mm	20 mm	300 Kg
844/6	100 mm	20 mm	300 Kg
844/7	120 mm	20 mm	300 Kg
844/8	140 mm	20 mm	300 Kg
844/9	160 mm	20 mm	300 Kg

SERIE PESANTE - n. 2 CUSCINETTI
HEAVY MODEL with nr. 2 BEARINGS

Cod. art. Art. no.	Ø/dia	SPESSORE WIDTH	PORTATA CAPACITY
844/10	100 mm	30 mm	600 Kg
844/11	120 mm	30 mm	600 Kg
844/12	140 mm	30 mm	600 Kg
844/13	160 mm	30 mm	800 Kg
844/14	200 mm	30 mm	800 Kg

SERIE PESANTE con INGRASSATORE
- n. 2 CUSCINETTI -
HEAVY MODEL with GREASE RECEIVER
- nr. 2 BEARINGS -

Cod. Art. Art. no.	Ø/dia	SPESSORE WIDTH	PORTATA CAPACITY
844/15	90 mm	30 mm	600 Kg
844/16	100 mm	30 mm	600 Kg
844/17	120 mm	30 mm	600 Kg
844/18	140 mm	30 mm	600 Kg
844/19	160 mm	30 mm	600 Kg



GOLA a "RAGGIO"
"ROUNDE" GROOVE

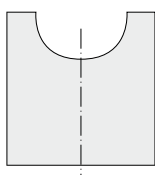

SERIE PESANTE - 10 mm
HEAVY MODEL - 10 mm

Cod. art. Art. no.	Ø/dia	SPESSORE WIDTH	PORTATA CAPACITY
844/29	100 mm	30 mm	600 Kg
844/30	120 mm	30 mm	600 Kg
844/31	140 mm	30 mm	600 Kg
844/32	160 mm	30 mm	600 Kg
844/33	200 mm	30 mm	600 Kg

SERIE LEGGERA - 7,5 mm
LIGHT MODEL - 7,5 mm

Cod. art. Art. no.	Ø/dia	SPESSORE WIDTH	PORTATA CAPACITY
844/20	50 mm	20 mm	300 Kg
844/21	60 mm	20 mm	300 Kg
844/22	70 mm	20 mm	300 Kg
844/23	80 mm	20 mm	300 Kg
844/24	90 mm	20 mm	300 Kg
844/25	100 mm	20 mm	300 Kg
844/26	120 mm	20 mm	300 Kg
844/27	140 mm	20 mm	300 Kg
844/28	160 mm	20 mm	300 Kg

**RUOTE GUIDA
SUPERIORI
CILINDRICHE**
Ø 30 mm

**CILINDRICAL UPPER
GUIDINGWHEELS**
for GATES
dia 30 mm



Art. 845/17

**RUOTE GUIDA
SUPERIORI
CILINDRICHE**
Ø 35 mm

**CILINDRICAL UPPER
GUIDINGWHEELS**
for GATES
dia 35 mm



Art. 846/4



GOLA a "V"
"V" GROOVE

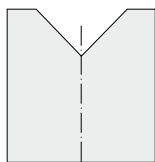

RUOTE con SUPPORTO INTERNO TIPO "F"
WHEELS with INTERNAL SUPPORT MODEL "F"

Cod. art. Art. no.	Ø/dia	SPESSORE WIDTH	CUSCINETTI BEARINGS	PORTATA CAPACITY
845/20	75 mm	20 mm	1	300 Kg
845/1	80 mm	20 mm	1	300 Kg
845/2	90 mm	20 mm	1	300 Kg
845/3	100 mm	20 mm	1	300 Kg
845/4	120 mm	20 mm	1	300 Kg
845/5	120 mm	30 mm	2	600 Kg
845/6	140 mm	20 mm	1	300 Kg
845/7	140 mm	30 mm	2	600 Kg



GOLA a "LJ"
"LJ" GROOVE

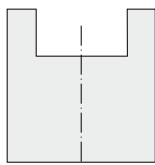

Cod. art. Art. no.	Ø/dia	SPESSORE WIDTH	GOLA GROOVE	CUSCINETTI BEARINGS	PORTATA CAPACITY
845/21	75 mm	18 mm	7 mm	1	300 Kg
845/22	100 mm	22 mm	8 mm	1	300 Kg
845/23	100 mm	30 mm	21 mm	1	300 Kg
845/24	120 mm	22 mm	8 mm	1	300 Kg
845/25	120 mm	30 mm	21 mm	1	300 Kg

PIASTRE GUIDA per CANCELLO
200 mm - 4 OLIVE

GATE GUIDING PLATE
200 mm - 4 GUIDING BEARING



Art. 845/18

PIASTRE GUIDA per CANCELLO
60 mm - 2 OLIVE

GATE GUIDING PLATE
60 mm - 2 GUIDING BEARING

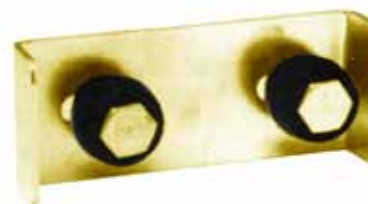

Art. 845/19

SERIE LEGGERA - LIGHT MODEL



GOLA a "LJ"
"LJ" GROOVE

Cod. art. Art. no.	Ø/dia	SPESSORE WIDTH	GOLA GROOVE	CUSCINETTI BEARINGS	PORTATA CAPACITY
846/6	60 mm	17 mm	6 mm	1	100 Kg
846/7	75 mm	18 mm	7 mm	1	150 Kg
846/8	90 mm	20 mm	8 mm	1	170 Kg
846/9	100 mm	22 mm	8 mm	1	200 Kg
846/10	120 mm	22 mm	8 mm	1	200 Kg
846/11	140 mm	25 mm	16 mm	1	250 Kg
846/12	160 mm	25 mm	16 mm	1	300 Kg

SERIE PESANTE - HEAVY MODEL

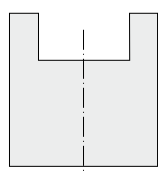

Cod. art. Art. no.	Ø/dia	SPESSORE WIDTH	GOLA GROOVE	CUSCINETTI BEARINGS	PORTATA CAPACITY
846/13	90 mm	25 mm	16 mm	1	200 Kg
846/14	120 mm	30 mm	21 mm	1	400 Kg
846/15	160 mm	30 mm	21 mm	1	500 Kg
846/16	200 mm	30 mm	21 mm	1	600 Kg
846/17	250 mm	32 mm	22 mm	1	800 Kg

PIASTRE GUIDA per CANCELLO
4 OLIVE

GATE GUIDING PLATE
4 GUIDING BEARING

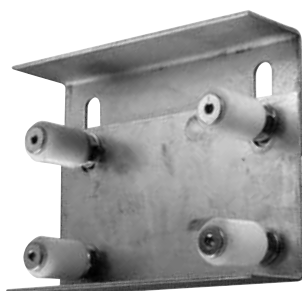

Art. 846/5

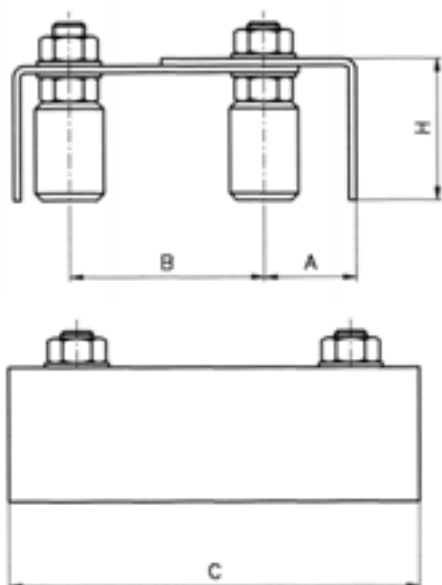

A	40 ÷ 80 mm
B	40 ÷ 50 mm
C	220 mm
H	59 mm



GOLA a "V"
"V" GROOVE

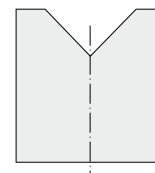

RUOTE con SUPPORTO INTERNO TIPO "I"
WEELS with INTERNAL SUPPORT MODEL "I"

Cod. art. Art. no.	Ø/dia	SPESSORE WIDTH	GOLA GROOVE	CUSCINETTI BEARINGS	PORTATA CAPACITY
845/8	60 mm	20 mm	20 mm	1	300 Kg
845/9	70 mm	20 mm	20 mm	1	300 Kg
845/10	80 mm	20 mm	20 mm	1	400 Kg
845/11	90 mm	20 mm	20 mm	1	400 Kg
845/12	100 mm	20 mm	20 mm	1	400 Kg
845/13	120 mm	20 mm	20 mm	1	400 Kg
845/14	120 mm	30 mm	30 mm	2	600 Kg
845/15	140 mm	20 mm	20 mm	1	400 Kg
845/16	140 mm	30 mm	30 mm	2	600 Kg



GOLA a "U"
"U" GROOVE

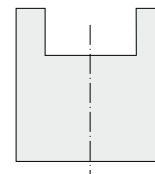

Cod. art. Art. no.	Ø/dia	SPESSORE WIDTH	GOLA GROOVE	CUSCINETTI BEARINGS	PORTATA CAPACITY
845/26	75 mm	18 mm	8 mm	1	180 Kg
845/27	90 mm	20 mm	8 mm	1	200 Kg
845/28	100 mm	22 mm	8 mm	1	220 Kg
845/29	120 mm	25 mm	16 mm	2	400 Kg
845/30	140 mm	25 mm	16 mm	2	420 Kg

GOLA a "U"
"U" GROOVE

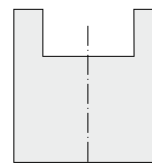

GOLA a "V"
"V" GROOVE

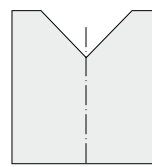

Cod. art. Art. no.	Ø/dia	SPESSORE WIDTH	GOLA GROOVE	CUSCINETTI BEARINGS	PORTATA CAPACITY
846/18	75 mm	25 mm	13 mm	1	200 Kg
846/19	75 mm	25 mm	16 mm	1	200 Kg
846/20	100 mm	25 mm	16 mm	1	400 Kg

Cod. art. Art. no.	Ø/dia	SPESSORE WIDTH	GOLA GROOVE	CUSCINETTI BEARINGS	PORTATA CAPACITY
846/21	75 mm	25 mm		1	200 Kg
846/22	100 mm	25 mm		2	400 Kg

Art. 869/1
150 kg



Art. 869/2
H 500 mm
Ø 500 mm

Art. 870/1
50 kg



Art. 870/2
H 580 mm
Ø 350 mm

Art. 870/3
100 kg



Art. 870/4
H 530 mm
Ø 400 mm

Ø = diameter

INCUDINI
SAGOMATORI

MODELLING
ANVILS



Art. 872/1
Ø 5 mm



Art. 872/2
Ø 10 mm



Art. 872/3
Ø 20 mm



Art. 872/4
Ø 25 mm



Art. 872/5
Ø 30 mm



Art. 872/6
Ø 5 mm



Art. 872/7
Ø 10 mm



Art. 872/8
Ø 15 mm



Art. 872/9
Ø 20 mm



Art. 872/10
Ø 25 mm



Art. 872/11
Ø 30 mm



DIMA
CALIBRATRICE
FORGING TOOLS
and EQUIPEMENT

Art. 871/1
H 840 mm
L 350 mm

INCUDINE PIANO
PLAIN ANVIL

Art. 873/1

INCUDINE INCISORE
ENGRAVING ANVIL

Art. 873/2

INCUDINE INCISORE
ENGRAVING ANVIL

Art. 873/3



ARTEFERRO

ELEMENTI VARI - VARIOUS ELEMENTS

SCALPELLI SAGOMATORI PIANI
FLAT MODELLING CHISELS

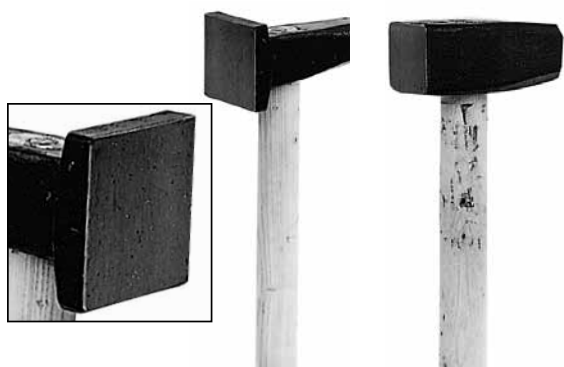

Art. 874/4
70 x 70 mm

Art. 874/5
50 x 50 mm

MAZZETTE - LITTLE SLEDGEHAMMERS



Art. 874/1
1,5 kg

Art. 874/2
1,5 kg

Art. 874/3
2,0 kg

SCALPELLI A COLTELLO - KNIFE SHAPED CHISELS



Art. 875/7
1,0 kg

Art. 875/8
1,5 kg

Art. 875/9
2,0 kg

MAZZE - SLEDGEHAMMERS



Art. 875/1
3,0 kg

Art. 875/2
4,0 kg

Art. 875/3
5,0 kg

SCALPELLI INCISORI - ENGRAVING CHISELS



Art. 875/10
1,0 kg

Art. 875/11
1,5 kg

Art. 875/12
2,0 kg



Art. 875/4
6,0 kg

Art. 875/5
8,0 kg

Art. 875/6
10,0 kg

SCALPELLI SAGOMATORI - MODELLING CHISELS

Ø = diameter

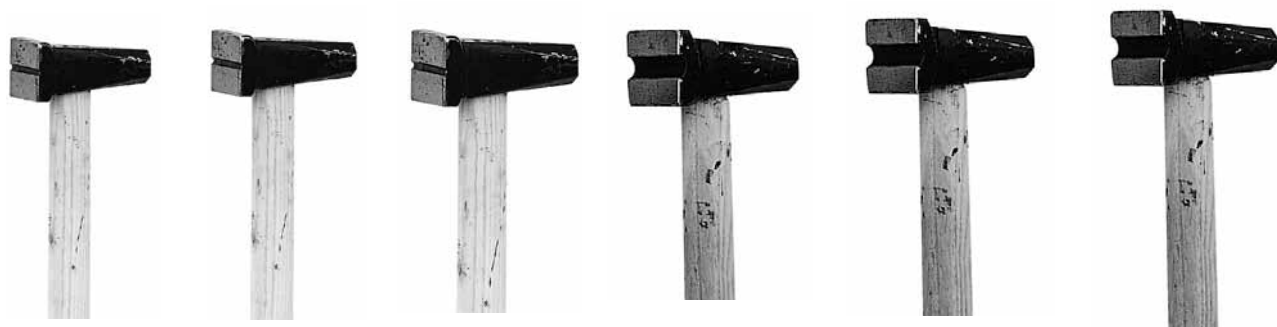

Art. 876/6
Ø 5 mm

Art. 876/7
Ø 10 mm

Art. 876/8
Ø 15 mm

Art. 876/9
Ø 20 mm

Art. 876/10
Ø 25 mm

Art. 876/11
Ø 30 mm



Art. 876/1
Ø 5 mm



Art. 876/2
Ø 10 mm



Art. 876/3
Ø 20 mm



Art. 876/4
Ø 25 mm



Art. 876/5
Ø 30 mm

Ø = diameter

CACCIACUNEO a PUNTA QUADRA
SQUARE TIPPED COTTERS DRIVER



Art. 877/1
□ 10 mm



Art. 877/2
□ 15 mm



Art. 877/3
□ 20 mm



Art. 877/4
□ 25 mm

CACCIACUNEO a PUNTA TONDA
ROUND TIPPED COTTERS DRIVER

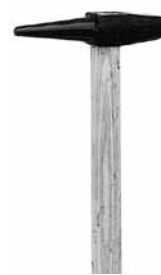

Art. 877/5
Ø 10 mm



Art. 877/6
Ø 15 mm



Art. 877/7
Ø 20 mm



Art. 877/8
Ø 25 mm

TENAGLIE STAMPATE - L 500 mm
HOT STAMPED BLACKSMITH'S TONGS - L 500 mm



Art. 878/1



Art. 878/5



Art. 878/2



Art. 878/6



Art. 878/3



Art. 878/7



Art. 878/4



Art. 878/8

TENAGLIE FORGIATE - L 450 mm
FORGED BLACKSMITH'S TONGS - L 500 mm

Art. 879/1



Art. 879/2



Art. 879/3



FORNO SINGOLO - SINGLE OVEN

Art. 1559/1

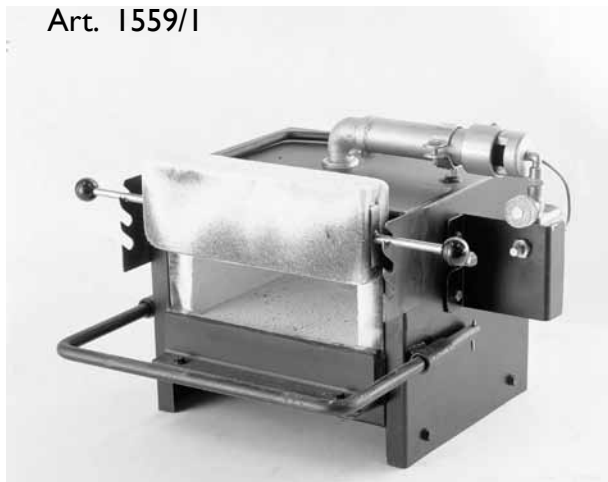

Misure esterne - External measures:

L 310 mm - H 255 mm - P 255 mm

Misure interne - Internal measures:

L 200 mm - H 250 mm - P 90 mm

FORNO DOPPIO - DOUBLE OVEN

Art. 1559/2

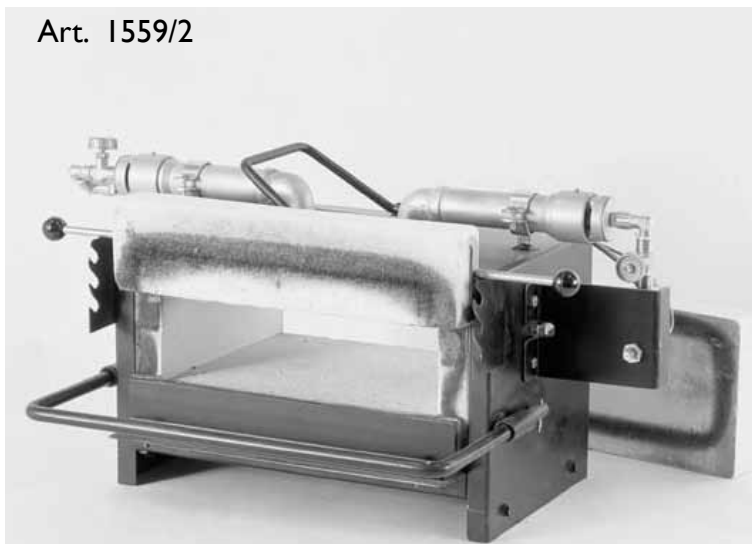

Misure esterne - External measures:

L 410 mm - H 255 mm - P 255 mm

Misure interne - Internal measures:

L 300 mm - H 250 mm - P 90 mm

PICCOLA "FORGIA"
SMALL "FORGE"

TRASPORTABILE a MANO
TRANSPORTABLE by HAND

CARATTERISTICHE PRINCIPALI:
MAIN FEATURES:

- Temperatura massima 1300 °C
- Maximum Temperature 1300°C
- Accensione facilitata
- Easy ignition
- Dispositivo di sicurezza in caso di spegnimento accidentale
- Safety device, in case of any sudden or accidental malfunction
- Forno a passaggio totale (avanti / dietro) per l'inserimento anche di verghe lunghe
- Opening on two sides (front / back) to insert long bars
- La camera di combustione è isolata con pannelli in fibrocera e base in refrattario
- The combustion chamber is isolated with ceramic fiber panels made of refractory material
- Lo schermo a chiusura regolabile permette un risparmio di energia e garantisce la massima sicurezza
- The front screen with its adjustable opening, allow for energy saving and guarantees the maximum security)

I FORNI RISPONDONO ALLE VIGENTI
NORMATIVE INTERNAZIONALI DI SICUREZZA
THE OVENS CORRESPOND TO THE
INTERNATIONAL SECURITY SAFETY LAW (EC)

Direttive CEE 89/392 modificate con Direttive
CEE 91/368 e 93/68, Direttive CEE 89/336
modificate dalle Direttive CEE 93/68

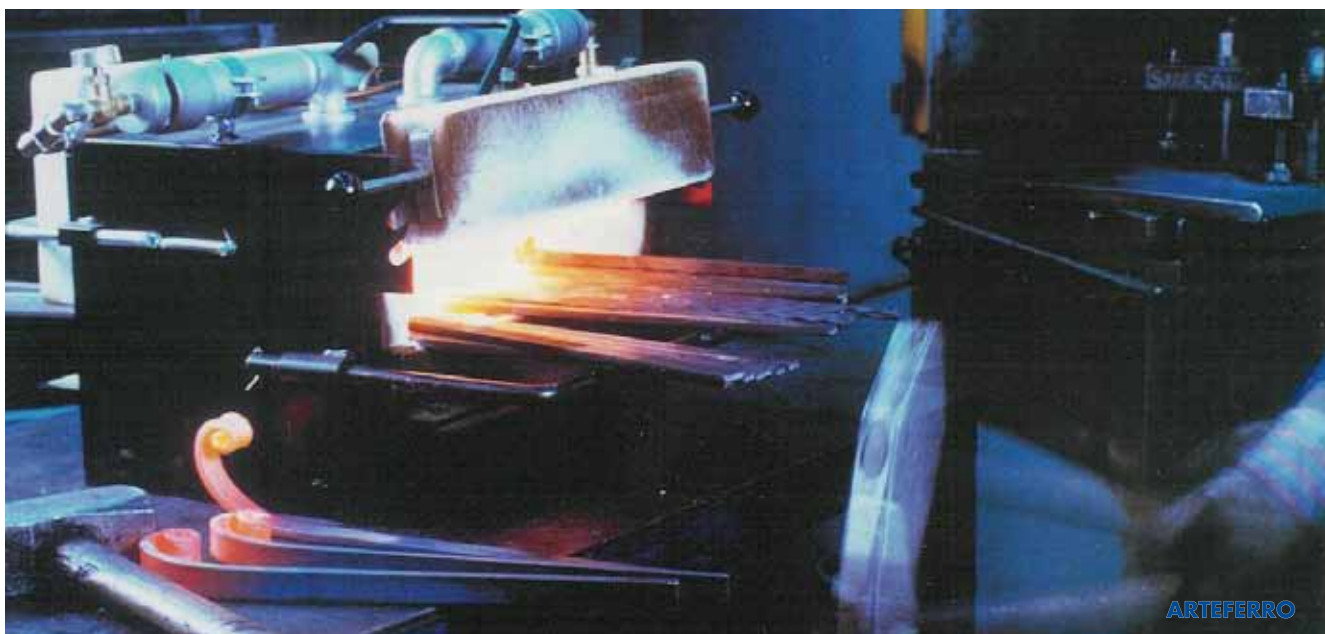

ARTEFERRO

GUANTI da LAVORO - WORKING WELDING and DRIVING GLOVES



Crosta di Maiale
Swine skin
Art. 880/1



Crosta di Maiale
Swine skin
Art. 880/2



Cotone e Lattice
Cotton and lates
Art. 880/3



Lungo per saldatura
Welding glove-long
Art. 880/4



Corto per saldatura
Welding glove-short
Art. 880/5

DISCHI da TAGLIO CUT-OFF WHELLS

Art. 881/1
Ø 115 mm
3,40 x 22 mm

Art. 881/2
Ø 230 mm
3,40 x 22 mm

Art. 881/3
Ø 300 mm
3,00 x 22 mm
fissi /fix

DISCHI SMERIGLIO GRINDING WHELLS

Art. 881/4
Ø 115 mm
6,00 x 22 mm

Art. 881/5
Ø 230 mm
6,00 x 22 mm



DISCHI LAMELLARI LAMINATED WHELLS

Art. 881/6
Ø 115 x 22 mm
grana/grain 40

Art. 881/7
Ø 230 x 22 mm
grana/grain 60

Art. 881/8
Ø 115 x 22 mm
grana/grain 80

Art. 881/9
Ø 115 x 22 mm
grana/grain 120



Ø = diameter

ELETTRODI per SALDATURA - WELDING ELECTRODES



Cod. art./Art. no.	882/1	882/2	882/3
Misure Dimensions	Ø 2,5 mm L 300 mm	Ø 3,25 mm L 350 mm	Ø 3,25 mm L 400 mm
Scatole sul bancale - Boxes per pallet	240	234	160
Pezzi in ogni scatola - Pieces per box	290	180	157
Peso per bancale - Height of pallet	1200 kg	1200 kg	1200 kg

ZINCO LIQUIDO SPRAY
Ideale per piccoli ritocchi
LIQUID ZINC SPRAY
Perfect for "toch-ups"



Art. 185/9

ANTI SPRUZZO di
SALDATURA
ANTI STICK SPRAY
for WELDING



Art. 883/1

SPRAY SBLOCCANTE
UNLOCKING SPRAY



Art. 883/3

ANCORANTE CHIMICO
QUICK CEMENT



Art. 883/4

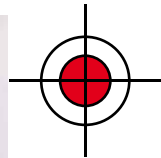

REIMESSKO

Sistema brevettato
DIMA e MISURATORE
per ringhiera di Scale

STAIRCASE
TEMPLATE and MEASURING
Patented System

Art. 882/4

kit di due casse inclusi gli utensili
per il montaggio

Set of two cases including tools for fastening



Il sistema REIMESSKO permette di:

- costruire, dall'inizio alla fine, la ringhiera di una scala, anche a sviluppo irregolare, completamente nella propria officina
- montare velocemente la ringhiera in cantiere;
- risparmiare, per ogni ringhiera, anche 8 - 10 ore di manodopera

The patented REIMESSKO system it is possible to:

- completely build the staircase in the workshop
- easily install the staircase in site with a small amount of handling
- for every staircase you build you can save 8 - 10 hours

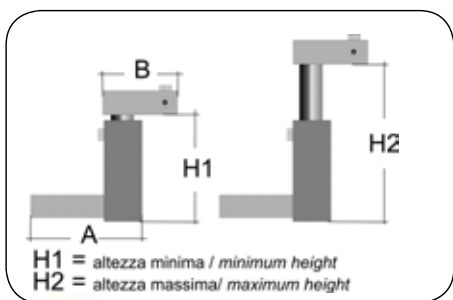

Art. 1905/2

A = 120 mm
B = 85 mm
H1 = 160 mm
H2 = 235 mm



Art. 1905/3

A = 210 mm
B = 155 mm
H1 = 160 mm
H2 = 235 mm



Art. 1905/4

A = 90 mm
B = 55 mm
H1 = 160 mm
H2 = 235 mm



Art. 1905/5

A = 150 mm
B = 85 mm
H1 = 160 mm
H2 = 235 mm



Art. 1905/6

A = 90 mm
B = 55 mm
H1 = 160 mm
H2 = 235 mm



Art. 1905/7

A = 90 mm
B = 55 mm
H1 = 310 mm
H2 = 500 mm



Art. 1905/1

A = 120 mm
B = 55 mm
H1 = 160 mm
H2 = 235 mm



Art. 1905/8

L 200 mm



Art. 1905/9

L 150 mm



Art. 1905/10

L 100 mm



Art. 1905/12

L 80 mm



Art. 1905/13

L 50 mm



Art. 1905/14



Art. 1905/15



Art. 1905/16

foro/hole 35 x 35 mm
H 100 mm
Flange Ø 140 mm



Art. 1905/17

foro/hole
35 x 35 mm



Art. 1905/18

foro/hole
35 x 35 mm



Art. 1905/19

ELEMENTI VARI - VARIOUS ELEMENTS



6 x 20 mm - **Art. 41/17**
 6 x 25 mm - **Art. 41/18**
 6 x 30 mm - **Art. 41/19**
 6 x 35 mm - **Art. 41/20**
 6 x 40 mm - **Art. 41/21**
 6 x 45 mm - **Art. 41/22**
 6 x 50 mm - **Art. 41/23**
 6 x 60 mm - **Art. 41/24**

7 x 25 mm - **Art. 41/13**

8 x 8 mm - **Art. 41/14** - (disponibile anche in ottone / available also in brass)
 8 x 20 mm - **Art. 41/15** - (disponibile anche in ottone / available also in brass)
 8 x 25 mm - **Art. 41/1** - (disponibile anche in ottone / available also in brass)
 8 x 30 mm - **Art. 41/4** - (disponibile anche in ottone / available also in brass)
 8 x 35 mm - **Art. 41/5** - (disponibile anche in ottone / available also in brass)
 8 x 40 mm - **Art. 41/6** - (disponibile anche in ottone / available also in brass)
 8 x 45 mm - **Art. 41/16** - (disponibile anche in ottone / available also in brass)
 8 x 50 mm - **Art. 41/7** - (disponibile anche in ottone / available also in brass)
 8 x 60 mm - **Art. 41/8** - (disponibile anche in ottone / available also in brass)



Art. 41/10
6 x 40 mm

Art. 41/9
8 x 40 mm



Art. 695/12
13 x 63 mm



testa
head
Ø 17 mm

Art. 41/11
L 25 mm
Ø 8 mm

Art. 41/12
L 30 mm
Ø 8 mm



una punta
one point

Art. 171/37
12 x 12 mm

Art. 171/38
15 x 15 mm

Art. 171/39
20 x 20 mm



due punte
two points

Art. 171/40
15 x 15 mm

Art. 171/41
20 x 20 mm

Art. 171/42
25 x 25 mm



CHIODI FORGIATI / HAND FORGED RIVETS

Art. 1474/6

Testa/Head 30 mm
L 285 mm
sez./sect. 14 x 14 mm

Art. 1474/7

Testa/Head 30 mm
L 210 mm
sez./sect. 12 x 12 mm

Art. 1474/8

Testa/Head 25 mm
L 160 mm
sez./sect. 10 x 10 mm

Art. 1474/9

Testa/Head 20 mm
L 105 mm
sez./sect. 8 x 8 mm

Art. 1474/10

Testa/Head 13 mm
L 70 mm
sez./sect. 5 x 5 mm

Ø = diameter

VITI AUTOFILETTANTI / SELF-TAPPING SCREW



Art. 695/6
Testa/Head
30 x 30 mm
L 90 mm
Ø 10 mm



Art. 695/7
Testa/Head
22 x 22 mm
L 75 mm
Ø 8 mm



Art. 695/8
Testa/Head
16 x 16 mm
L 62 mm
Ø 8 mm



Art. 695/9
Testa/Head
Ø 35 mm
L 90 mm
Ø 10 mm



Art. 695/10
Testa/Head
Ø 24 mm
L 85 mm
Ø 8 mm



Art. 695/11
Testa/Head
Ø 18 mm
L 62 mm
Ø 8 mm



Art. 1405/1
 Base 25 x 8 mm
 Fori/Holes Ø 8,5 mm
 φ 12 x 12 mm



Art. 1405/2
 Base Ø 80 mm
 Fori/Holes Ø 8,5 mm
 φ 12 x 12 mm



Art. 1405/3
 Base Ø 80 mm
 Fori/Holes Ø 8,5 mm
 Ø 16 mm

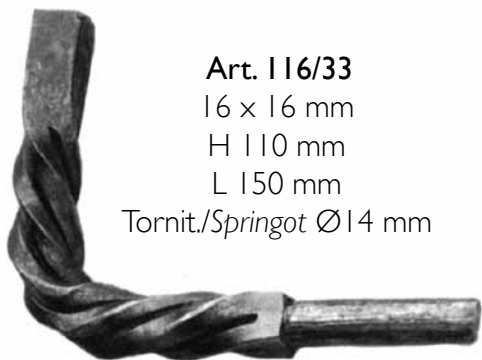

Art. 116/33
 16 x 16 mm
 H 110 mm
 L 150 mm
 Tornit./Springot Ø14 mm

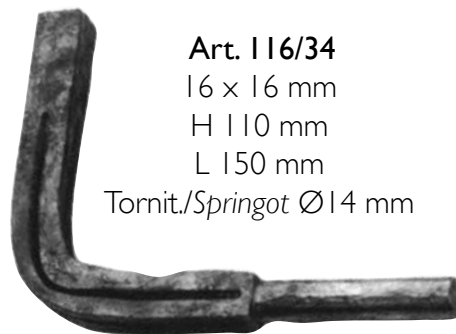

Art. 116/34
 16 x 16 mm
 H 110 mm
 L 150 mm
 Tornit./Springot Ø14 mm



Art. 116/35
 Ø 65 mm
 8 mm
 Foro/Hole Ø 15 mm

Ø = diameter



Art. 94/A/1
 H 160 mm
 L 95 mm



Art. 94/A/2
 H 160 mm
 L 95 mm



ARTEFERRO



Art. 82/2
10 x 5 mm
H 105 mm



Art. 30/6
8 x 8 mm
H 75 mm



Art. 81/2
8 x 8 mm
H 125 mm



Art. 83/9
8 x 8 mm
H 120 mm



Art. 83/2
8 x 8 mm
H 120 mm



Art. 83/4
8 x 8 mm
H 120 mm



Art. 83/6
8 x 8 mm
H 120 mm



Art. 83/13
8 x 8 mm
H 120 mm



Art. 83/11
8 x 8 mm
H 120 mm



Art. 89/4
8 x 8 mm
H 55 mm



Art. 83/10
8 x 8 mm
H 60 mm



Art. 83/3
8 x 8 mm
H 60 mm



Art. 83/5
8 x 8 mm
H 60 mm



Art. 83/7
8 x 8 mm
H 60 mm



Art. 83/8
8 x 8 mm
H 60 mm



Art. 83/12
8 x 8 mm
H 60 mm



Art. 81/6
8 x 8 mm
L 120 mm



Art. 81/8
8 x 8 mm
L 110 mm



Art. 82/8
20 x 3 mm
L 135 mm



Art. 198/1
20 x 6 mm
L 140 mm



Art. 85/1
8 x 8 mm
L 125 mm



Art. 34/3
12 x 12 mm
H 175 mm
L 110 mm



Art. 81/4
8 x 8 mm
L 90 mm



Art. 82/6
Ø 10 mm
L 90 mm

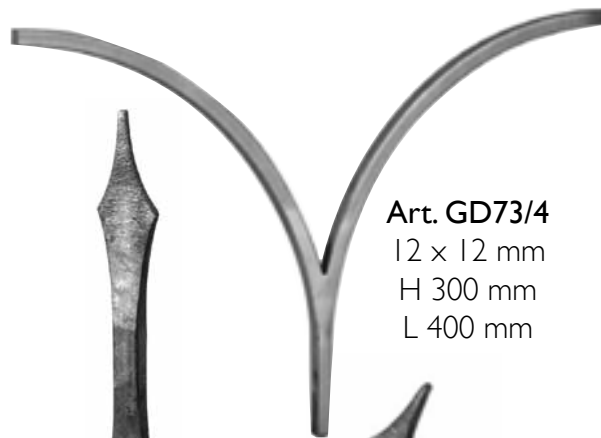

Art. GD73/4
12 x 12 mm
H 300 mm
L 400 mm

Art. 82/4
Ø 8 mm
L 90 mm



Art. 88/L/2
14 x 8 mm
L 135 mm



Art. 85/6
12 x 12 mm
L 225 mm



Art. 40/B/8
12 x 12 mm
L 220 mm



Art. 70/B/7
12 x 12 mm
190 x 70 mm

Art. 40/B/8
14 x 14 mm
L 220 mm



ARTEFERRO



Art. 852/8

spess./thick. 6 mm
H 70 mm - L 1218 mm

Art. 852/9

spess./thick. 2 mm
H 45 mm - L 1212 mm



Art. 852/10

spess./thick. 8 mm
H 124 mm - L 1206 mm

Art. 852/11

spess./thick. 2 mm
H 45 mm - L 1215 mm



Art. 852/6

spess./thick. 6 mm
H 84 mm - L 1152 mm

Art. 852/7

spess./thick. 2 mm
H 45 mm - L 1213 mm



Art. 852/12

spess./thick. 6 mm
H 70 mm - L 1196 mm

Art. 852/13

spess./thick. 2 mm
H 45 mm - L 1212 mm



Art. 852/14

spess./thick. 6 mm
H 84 mm - L 1160 mm

Art. 852/15

spess./thick. 2 mm
H 45 mm - L 1242 mm

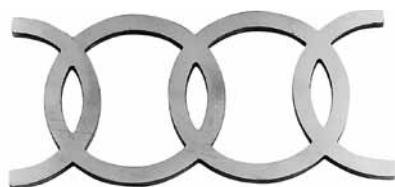

Art. 852/4

spess./thick. 8 mm
H 124 mm - L 1129 mm



Art. 852/5

spess./thick. 6 mm
H 84 mm - L 1140 mm



ARTEFERRO



Art. 1813/1

14 x 6 mm
H 155 mm
L 755 mm

Art. 1813/3

14 x 6 mm
H 155 mm
L 580 mm

Art. 1813/4

14 x 6 mm
H 155 mm
L 415 mm



Art. 1813/2

14 x 6 mm
H 155 mm
L 250 mm



Art. 1813/6

14 x 6 mm
H 190 mm
L 960 mm

Art. 1813/5

14 x 6 mm
H 190 mm
L 580 mm



ARTEFERRO



spess./thick. 3 mm - H 55 mm - L 1000 mm

Art. 1409/1
liscio/plain

Art. 1410/1
coniato/hammered



spess./thick. 3 mm - H 55 mm - L 990 mm

Art. 1409/2
liscio/plain

Art. 1410/2
coniato/hammered



spess./thick. 3 mm - H 55 mm - L 990 mm

Art. 1409/3
liscio/plain

Art. 1410/3
coniato / hammered



spess./thick. 3 mm - H 45 mm - L 990 mm

Art. 1409/4
liscio/plain

Art. 1410/4
coniato/hammered



spess./thick. 3 mm - H 37 mm - L 990 mm

Art. 1409/5
liscio/plain

Art. 1410/5
coniato/hammered



spess./thick. 3 mm - H 63 mm - L 960 mm

Art. 1409/6
liscio/plain

Art. 1410/6
coniato/hammered



spess./thick. 3 mm - H 55 mm - L 960 mm

Art. 1409/7
liscio/plain

Art. 1410/7
coniato / hammered



spess./thick. 3 mm - H 55 mm - L 993 mm

Art. 1409/8
liscio/plain

Art. 1410/8
coniato/hammered



Art. 1411/1

12 x 6 mm - H 165 mm - L 1230 mm



Art. 1411/2

12 x 6 mm - H 165 mm - L 1160 mm - incl. 30°



Art. 1411/3

spess./thickness 2 mm - H 45 mm - L 1230 mm



Art. 1411/5

spess./thickness 6 mm - H 84 mm - L 1225 mm
incl. 30°

Art. 1411/4

spess./thickness 6 mm - H 84 mm - L 1250 mm

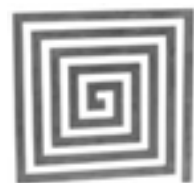

Art. 1411/6

10 x 5 mm
H 200 mm
L 200 mm



Art. 1411/9

spess./thick.
5 mm
Ø 100 mm



12 x 12 mm

Art. 1321/1

100 x 100 mm

Art. 1321/3

120 x 125 mm

14 x 14 mm

Art. 1321/2

100 x 100 mm

Art. 1321/4

120 x 125 mm

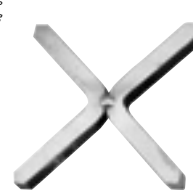

12 x 12 mm

Art. 1321/5

100 x 100 mm

Art. 1321/7

120 x 125 mm

14 x 14 mm

Art. 1321/6

100 x 100 mm

Art. 1321/8

120 x 125 mm



12 x 12 mm

Art. 1321/9

100 x 100 mm

Art. 1321/11

120 x 125 mm

14 x 14 mm

Art. 1321/10

100 x 100 mm

Art. 1321/12

120 x 125 mm



Art. 1411/7

spess./thick.
5 mm
H 100 mm
L 100 mm



Art. 1411/8

spess./thick.
5 mm
H 115 mm
L 187 mm





Art. 1412/1
coniato
hammered

Art. 1413/1
liscio/plain

H 240 x L 215 mm



Art. 1412/4
coniato
hammered

Art. 1413/4
liscio/plain

H 240 x L 240 mm



Art. 1412/7
coniato
hammered

Art. 1413/7
liscio/plain

H 225 x L 175 mm



Art. 1412/10
coniato
hammered

Art. 1413/10
liscio/plain

H 225 x L 150 mm



Art. 1412/13
coniato
hammered

Art. 1413/13
liscio/plain

H 215 x L 200 mm



Art. 1412/16
coniato
hammered

Art. 1413/16
liscio/plain

H 240 x L 210 mm



Art. 1412/19
coniato
hammered

Art. 1413/19
liscio/plain

H 235 x L 125 mm



Art. 1412/22
coniato
hammered

Art. 1413/22
liscio/plain

H 200 x L 225 mm



Art. 1412/25
coniato
hammered

Art. 1413/25
liscio/plain

H 235 x L 150 mm



Art. 1412/2
coniato
hammered

Art. 1413/2
liscio/plain

H 215 x L 215 mm



Art. 1412/5
coniato
hammered

Art. 1413/5
liscio/plain

H 240 x L 135 mm



Art. 1412/8
coniato
hammered

Art. 1413/8
liscio/plain

H 235 x L 185 mm



Art. 1412/11
coniato
hammered

Art. 1413/11
liscio/plain

H 225 x L 200 mm



Art. 1412/14
coniato
hammered

Art. 1413/14
liscio/plain

H 230 x L 165 mm



Art. 1412/17
coniato
hammered

Art. 1413/17
liscio/plain

H 245 x L 195 mm



Art. 1412/20
coniato
hammered

Art. 1413/20
liscio/plain

H 230 x L 165 mm



Art. 1412/23
coniato
hammered

Art. 1413/23
liscio/plain

H 220 x L 220 mm



Art. 1412/26
coniato
hammered

Art. 1413/26
liscio/plain

H 220 x L 180 mm



Art. 1412/3
coniato
hammered

Art. 1413/3
liscio/plain

H 240 x L 160 mm



Art. 1412/6
coniato
hammered

Art. 1413/6
liscio/plain

H 230 x L 185 mm



Art. 1412/9
coniato
hammered

Art. 1413/9
liscio/plain

H 215 x L 120 mm



Art. 1412/12
coniato
hammered

Art. 1413/12
liscio/plain

H 215 x L 190 mm



Art. 1412/15
coniato
hammered

Art. 1413/15
liscio/plain

H 245 x L 170 mm



Art. 1412/18
coniato
hammered

Art. 1413/18
liscio/plain

H 225 x L 195 mm



Art. 1412/21
coniato
hammered

Art. 1413/21
liscio/plain

H 210 x L 170 mm



Art. 1412/24
coniato
hammered

Art. 1413/24
liscio/plain

H 210 x L 200 mm



Art. 1412/27
coniato
hammered

Art. 1413/27
liscio/plain

H 250 x L 250 mm



Art. 1414/1
coniato
hammered

Art. 1414/12
liscio/plain

H 250 x L 80 mm



Art. 1414/2
coniato
hammered

Art. 1414/13
liscio/plain

H 250 x L 130 mm



Art. 1414/3
coniato
hammered

Art. 1414/14
liscio/plain

H 250 x L 135 mm



Art. 1414/4
coniato
hammered

Art. 1414/15
liscio/plain

H 250 x L 125 mm



Art. 1414/5
coniato
hammered

Art. 1414/16
liscio/plain

H 250 x L 95 mm



Art. 1414/6
coniato
hammered

Art. 1414/17
liscio/plain

H 250 x L 120 mm



Art. 1414/7
coniato
hammered

Art. 1414/18
liscio/plain

H 250 x L 90 mm



Art. 1414/8
coniato
hammered

Art. 1414/19
liscio/plain

H 250 x L 110 mm



Art. 1414/9
coniato
hammered

Art. 1414/20
liscio/plain

H 250 x L 110 mm



Art. 1414/10
coniato
hammered

Art. 1414/21
liscio/plain

H 250 x L 120 mm



Art. 1412/28
coniato
hammered

Art. 1413/28
liscio/plain

H 220 x L 170 mm



Art. 1414/12
coniato
hammered

Art. 1414/22
liscio/plain

H 315 x L 2450 mm

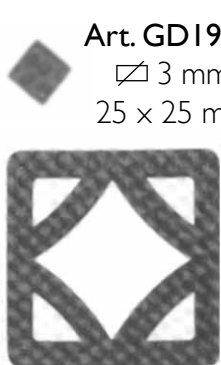

Art. GD199/1

∅ 3 mm
25 x 25 mm



Art. GD199/3

∅ 3 mm
60 x 160 mm



Art. GD199/4

∅ 3 mm
60 x 160 mm



Art. GD199/5

∅ 3 mm
120 x 160 mm



Art. GD199/6

∅ 3 mm
150 x 230 mm

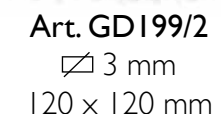

Art. GD199/2

∅ 3 mm
120 x 120 mm



Art. GD199/12

fasciette per
collars for



Art. GD199/7

∅ 3 mm
30 x 70 mm



Art. GD199/8

∅ 3 mm
80 x 70 mm



Art. GD199/10

fasciette per
collars for



Art. GD199/11

∅ 3 mm
45 x 25 mm



Art. GD199/16

∅ 3 mm
75 x 230 mm



Art. GD199/17

∅ 3 mm
75 x 230 mm



Art. GD199/13

∅ 3 mm
40 x 105 mm



Art. GD199/14

∅ 3 mm
40 x 105 mm



Art. GD199/9

fasciette per
collars for



Art. GD199/15

∅ 3 mm
80 x 105 mm

Da art. 850/1 ad art. 850/26 : spessore 6 mm - H 170 mm - L 130 mm / thickness 6 mm - H 170 mm - L 130 mm

● Da art. 850/27 ad art. 850/52 : spessore 3 mm - H 80 mm - L 55 mm / thickness 3 mm - H 80 mm - L 55 mm
e disegno diverso rispetto all'immagine / and drawing different from picture)



Art. 850/1

● Art. 850/27



Art. 850/2

● Art. 850/28



Art. 850/3

● Art. 850/29



Art. 850/4

● Art. 850/30



Art. 850/5

● Art. 850/31



Art. 850/6

● Art. 850/32



Art. 850/7

● Art. 850/33



Art. 850/8

● Art. 850/34



Art. 850/9

● Art. 850/35



Art. 850/10

● Art. 850/36



Art. 850/11

● Art. 850/37



Art. 850/12

● Art. 850/38



Art. 850/13

● Art. 850/39



Art. 850/14

● Art. 850/40



Art. 850/15

● Art. 850/41



Art. 850/16

● Art. 850/42



Art. 850/17

● Art. 850/43



Art. 850/18

● Art. 850/44



Art. 850/19

● Art. 850/45



Art. 850/20

● Art. 850/46



Art. 850/21

● Art. 850/47



Art. 850/22

● Art. 850/48



Art. 850/24

● Art. 850/50



Art. 850/25

● Art. 850/51



Art. 850/26

● Art. 850/52



Art. 850/23

● Art. 850/49

NUMERI
NUMBERS
☐ 3 mm



Art. 851/12

H 143 L 186
per un numero
for one number

Art. 851/13

H 169 L 212
fino a 3 numeri
up to 3 numbers

Art. 851/14

H 169 L 302
fino a 5 numeri
up to 5 numbers

Art. 851/15

H 169 L 392
fino a 7 numeri
up to 7 numbers



Art. 851/16

H 145 - L 193
fino a 3 numeri
up to 3 numbers

Art. 851/17

H 145 - L 273
fino a 5 numeri
up to 5 numbers

Art. 851/18

H 151 - L 353
fino a 7 numeri
up to 7 numbers



Art. 851/11
80 x 40 mm



Art. 851/1
80 x 40 mm



Art. 851/2
80 x 40 mm



Art. 851/3
80 x 40 mm



Art. 851/4
80 x 40 mm



Art. 851/5
80 x 40 mm



Art. 852/1
☐ 12 mm
H 290 mm
L 230 mm



Art. 851/6
80 x 40 mm



Art. 851/7
80 x 40 mm



Art. 851/8
80 x 40 mm



Art. 851/9
80 x 40 mm



Art. 851/10
80 x 40 mm



Art. 852/2
☐ 12 mm
H 240 mm
L 180 mm



H 60 / 100 mm

● SOLO PER QUANTITA'
ONLY FOR QUANTITIES

Art. 848/1



H 405 mm - L 255 mm
P 90 mm
ghisa/cast iron

- Lettera / Letter "A" Art. 171/11
- Lettera / Letter "B" Art. 171/12
- Lettera / Letter "C" Art. 171/13
- Lettera / Letter "D" Art. 171/14
- Lettera / Letter "E" Art. 171/15
- Lettera / Letter "F" Art. 171/16
- Lettera / Letter "G" Art. 171/17
- Lettera / Letter "H" Art. 171/18
- Lettera / Letter "I" Art. 171/19
- Lettera / Letter "J" Art. 171/20
- Lettera / Letter "K" Art. 171/21
- Lettera / Letter "L" Art. 171/22
- Lettera / Letter "M" Art. 171/23
- Lettera / Letter "N" Art. 171/24
- Lettera / Letter "O" Art. 171/25
- Lettera / Letter "P" Art. 171/26
- Lettera / Letter "Q" Art. 171/27
- Lettera / Letter "R" Art. 171/28
- Lettera / Letter "S" Art. 171/29
- Lettera / Letter "T" Art. 171/30
- Lettera / Letter "U" Art. 171/31
- Lettera / Letter "V" Art. 171/32
- Lettera / Letter "W" Art. 171/33
- Lettera / Letter "X" Art. 171/34
- Lettera / Letter "Y" Art. 171/35
- Lettera / Letter "Z" Art. 171/36



Art. 849/1
Bianco/White

Art. 849/2
Nero/Black

Art. 849/3
Rosso/Red

Art. 849/4
Verde/Green



Art. 848/2
H 455 mm - L 400 mm
P 155 mm
ghisa/cast iron



H 120 mm

- No. "1" Art. 171/1
- No. "2" Art. 171/2
- No. "3" Art. 171/3
- No. "4" Art. 171/4
- No. "5" Art. 171/5
- No. "6" Art. 171/6
- No. "7" Art. 171/7
- No. "8" Art. 171/8
- No. "9" Art. 171/9
- No. "0" Art. 171/0



Art. 5069/3
H 1100 mm
Base 330 x 240 mm
ghisa/cast iron



Art. 10314/1
762 x 762 mm



Art. 10314/2
698 x 965 mm



Art. 10314/3
482 x 673 mm



Art. 10314/4
546 x 546 mm



Art. 10315/1
635 x 508 mm



Art. 10315/2
635 x 546 mm

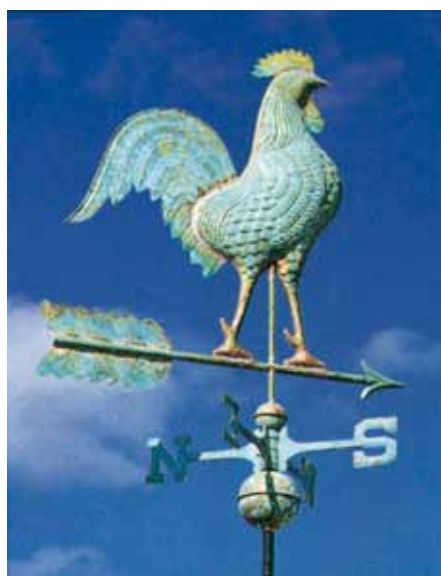

Art. 10315/3
685 x 698 mm



Art. 10316/1
787 x 571 mm



Art. 10315/6
558 x 520 mm



Art. 10315/4
736 x 558 mm



Art. 10316/7
610 x 570 mm



Art. 10316/8
558 x 533 mm



Art. 10316/3
635 x 406 mm



Art. 10316/4
774 x 444 mm



Art. 10316/5
698 x 406 mm



Art. 10316/2
736 x 520 mm

ACCESSORI - ACCESSORIES



Art. 10314/5
127 mm



Art. 10314/6
305 mm



Art. 10314/7
305 mm



Art. 10314/8
305 mm

ARIETE - ARIES



spess./thick. 3 mm
∅ 260 mm

Art. 892/2
grezzo/unpainted

Art. 10395/1
verniciato/painted

Art. 10393/9
con ganci e verniciato
with hook and painted

TORO - TAURUS



spess./thick. 3 mm
∅ 260 mm

Art. 892/1
grezzo/unpainted

Art. 10395/2
verniciato/painted

Art. 10393/1
con ganci e verniciato
with hook and painted

GEMELLI - GEMINI



spess./thick. 3 mm
∅ 260 mm

Art. 891/3
grezzo/unpainted

Art. 10395/3
verniciato/painted

Art. 10393/2
con ganci e verniciato
with hook and painted

CANCRO - CANCER



spess./thick. 3 mm
∅ 260 mm

Art. 891/6
grezzo/unpainted

Art. 10395/4
verniciato/painted

Art. 10393/3
con ganci e verniciato
with hook and painted

LEONE - LION



spess./thick. 3 mm
∅ 260 mm

Art. 892/4
grezzo/unpainted

Art. 10395/5
verniciato/painted

Art. 10393/4
con ganci e verniciato
with hook and painted

VERGINE - VIRGO



spess./thick. 3 mm
∅ 260 mm

Art. 892/5
grezzo/unpainted

Art. 10395/6
verniciato/painted

Art. 10393/5
con ganci e verniciato
with hook and painted

BILANCIA - LIBRA



spess./thick. 3 mm
∅ 260 mm

Art. 892/6
grezzo/unpainted

Art. 10395/7
verniciato/painted

Art. 10393/6
con ganci e verniciato
with hook and painted

SCORPIONE - SCORPIO



spess./thick. 3 mm
∅ 260 mm

Art. 892/3
grezzo/unpainted

Art. 10395/8
verniciato/painted

Art. 10393/7
con ganci e verniciato
with hook and painted

SAGITTARIO - SAGITTARIUS



spess./thick. 3 mm
∅ 260 mm

Art. 891/1
grezzo/unpainted

Art. 10395/9
verniciato/painted

Art. 10393/8
con ganci e verniciato
with hook and painted

CAPRICORNO - CAPRICORN



spess./thick. 3 mm
∅ 260 mm

Art. 891/2
grezzo unpainted

Art. 10395/10
verniciato/painted

Art. 10393/12
con ganci e verniciato
with hook and painted

ACQUARIO - AQUARIUS



spess./thick. 3 mm
∅ 260 mm

Art. 891/4
grezzo/unpainted

Art. 10395/11
verniciato/painted

Art. 10393/10
con ganci e verniciato
with hook and painted

PESCI - PISCES



spess./thick. 3 mm
∅ 260 mm

Art. 891/5
grezzo/unpainted

Art. 10395/12
verniciato/painted

Art. 10393/11
con ganci e verniciato
with hook and painted



spess./thick. 3 mm
Ø 260 mm

Art. 1538/1
grezzo/unpainted

Art. 1536/1
con ganci - grezzo
with hook - unpainted

Art. 1532/1
verniciato/painted

Art. 1530/1
con ganci e verniciato
with hook and painted



spess./thick. 3 mm
Ø 260 mm

Art. 1538/2
grezzo/unpainted

Art. 1536/2
con ganci - grezzo
with hook - unpainted

Art. 1532/2
verniciato/painted

Art. 1530/2
con ganci e verniciato
with hook and painted



spess./thick. 3 mm
Ø 260 mm

Art. 1538/3
grezzo/unpainted

Art. 1536/3
con ganci - grezzo
with hook - unpainted

Art. 1532/3
verniciato/painted

Art. 1530/3
con ganci e verniciato
with hook and painted



spess./thick. 3 mm
Ø 260 mm

Art. 1538/4
grezzo/unpainted

Art. 1536/4
con ganci - grezzo
with hook - unpainted

Art. 1532/4
verniciato/painted

Art. 1530/4
con ganci e verniciato
with hook and painted

Ø = diameter



spess./thick. 3 mm
Ø 260 mm

Art. 1538/5
grezzo/unpainted

Art. 1536/5
con ganci - grezzo
with hook - unpainted

Art. 1532/5
verniciato/painted

Art. 1530/5
con ganci e verniciato
with hook and painted



spess./thick. 3 mm
Ø 260 mm

Art. 1538/6
grezzo/unpainted

Art. 1536/6
con ganci - grezzo
with hook - unpainted

Art. 1532/6
verniciato/painted

Art. 1530/6
con ganci e verniciato
with hook and painted



spess./thick. 3 mm
Ø 260 mm

Art. 1538/7
grezzo/unpainted

Art. 1536/7
con ganci - grezzo
with hook - unpainted

Art. 1532/7
verniciato/painted

Art. 1530/7
con ganci e verniciato
with hook and painted



spess./thick. 3 mm
Ø 260 mm

Art. 1538/8
grezzo/unpainted

Art. 1536/8
con ganci - grezzo
with hook - unpainted

Art. 1532/8
verniciato/painted

Art. 1530/8
con ganci e verniciato
with hook and painted



spess./thick. 3 mm
Ø 260 mm

Art. 1539/1
grezzo/unpainted

Art. 1537/1
con ganci - grezzo
with hook - unpainted

Art. 1533/1
verniciato/painted

Art. 1531/1
con ganci e verniciato
with hook and painted



spess./thick. 3 mm
Ø 260 mm

Art. 1539/2
grezzo/unpainted

Art. 1537/2
con ganci - grezzo
with hook - unpainted

Art. 1533/2
verniciato/painted

Art. 1531/2
con ganci e verniciato
with hook and painted



spess./thick. 3 mm
Ø 260 mm

Art. 1539/3
grezzo/unpainted

Art. 1537/3
con ganci - grezzo
with hook - unpainted

Art. 1533/3
verniciato/painted

Art. 1531/3
con ganci e verniciato
with hook and painted



spess./thick. 3 mm
Ø 260 mm

Art. 1539/4
grezzo/unpainted

Art. 1537/4
con ganci - grezzo
with hook - unpainted

Art. 1533/4
verniciato/painted

Art. 1531/4
con ganci e verniciato
with hook and painted



spess./thick. 3 mm
Ø 260 mm

Art. 1539/5
grezzo/unpainted

Art. 1537/5
con ganci - grezzo
with hook - unpainted

Art. 1533/5
verniciato/painted

Art. 1531/5
con ganci e verniciato
with hook and painted



spess./thick. 3 mm
Ø 260 mm

Art. 1539/6
grezzo/unpainted

Art. 1537/6
con ganci - grezzo
with hook - unpainted

Art. 1533/6
verniciato/painted

Art. 1531/6
con ganci e verniciato
with hook and painted



spess./thick. 3 mm
Ø 260 mm

Art. 1539/7
grezzo/unpainted

Art. 1537/7
con ganci - grezzo
with hook - unpainted

Art. 1533/7
verniciato/painted

Art. 1531/7
con ganci e verniciato
with hook and painted



spess./thick. 3 mm
Ø 260 mm

Art. 1539/8
grezzo/unpainted

Art. 1537/8
con ganci - grezzo
with hook - unpainted

Art. 1533/8
verniciato/painted

Art. 1531/8
con ganci e verniciato
with hook and painted



spess./thick. 3 mm
Ø 260 mm

Art. 1539/9
grezzo/unpainted

Art. 1537/9
con ganci - grezzo
with hook - unpainted

Art. 1533/9
verniciato/painted

Art. 1531/9
con ganci e verniciato
with hook and painted



spess./thick. 3 mm
Ø 260 mm

Art. 1539/10
grezzo/unpainted

Art. 1537/10
con ganci - grezzo
with hook - unpainted

Art. 1533/10
verniciato/painted

Art. 1531/10
con ganci e verniciato
with hook and painted

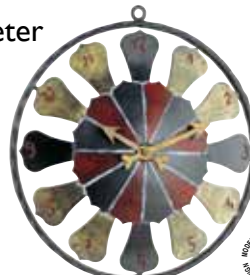

spess./thick. 3 mm
Ø 260 mm

Art. 1539/11
grezzo/unpainted

Art. 1537/11
con ganci - grezzo
with hook - unpainted

Art. 1533/11
verniciato/painted

Art. 1531/11
con ganci e verniciato
with hook and painted



spess./thick. 3 mm
Ø 260 mm

Art. 1539/12
grezzo/unpainted

Art. 1537/12
con ganci - grezzo
with hook - unpainted

Art. 1533/12
verniciato/painted

Art. 1531/12
con ganci e verniciato
with hook and painted

Ø = diameter



spess./thick. 3 mm
Ø 260 mm

Art. 1539/13
grezzo/unpainted

Art. 1537/13
con ganci - grezzo
with hook - unpainted

Art. 1533/13
verniciato/painted

Art. 1531/13
con ganci e verniciato
with hook and painted



spess./thick. 3 mm
Ø 260 mm

Art. 1539/14
grezzo/unpainted

Art. 1537/14
con ganci - grezzo
with hook - unpainted

Art. 1533/14
verniciato/painted

Art. 1531/14
con ganci e verniciato
with hook and painted



spess./thick. 3 mm
Ø 260 mm

Art. 1539/15
grezzo/unpainted

Art. 1537/15
con ganci - grezzo
with hook - unpainted

Art. 1533/15
verniciato/painted

Art. 1531/15
con ganci e verniciato
with hook and painted



spess./thick. 3 mm
Ø 260 mm

Art. 1539/16
grezzo/unpainted

Art. 1537/16
con ganci - grezzo
with hook - unpainted

Art. 1533/16
verniciato/painted

Art. 1531/16
con ganci e verniciato
with hook and painted



spess./thick. 3 mm
230 x 270 mm

Art. 1535/1
grezzo/unpainted

Art. 1534/1
verniciato/painted



spess./thick. 3 mm
200 x 230 mm

Art. 1535/2
grezzo/unpainted

Art. 1534/2
verniciato/painted



spess./thick. 3 mm
200 x 235 mm

Art. 1535/3
grezzo/unpainted

Art. 1534/3
verniciato/painted



spess./thick. 3 mm
240 x 255 mm

Art. 1535/4
grezzo/unpainted

Art. 1534/4
verniciato/painted



spess./thick. 3 mm
245 x 235 mm

Art. 1535/5
grezzo/unpainted

Art. 1534/5
verniciato/painted



spess./thick. 3 mm
190 x 220 mm

Art. 1535/6
grezzo/unpainted

Art. 1534/6
verniciato/painted



spess./thick. 3 mm
190 x 250 mm

Art. 1535/7
grezzo/unpainted

Art. 1534/7
verniciato/painted



spess./thick. 3 mm
210 x 230 mm

Art. 1535/8
grezzo/unpainted

Art. 1534/8
verniciato/painted



spess./thick. 3 mm
185 x 240 mm

Art. 1535/9
grezzo/unpainted

Art. 1534/9
verniciato/painted



spess./thick. 3 mm
210 x 250 mm

Art. 1535/10
grezzo/unpainted

Art. 1534/10
verniciato/painted



spess./thick. 3 mm
240 x 220 mm

Art. 1535/11
grezzo/unpainted

Art. 1534/11
verniciato/painted



spess./thick. 3 mm
240 x 170 mm

Art. 1535/12
grezzo/unpainted

Art. 1534/12
verniciato/painted



spess./thick. 3 mm
180 x 230 mm

Art. 1535/13
grezzo/unpainted

Art. 1534/13
verniciato/painted



spess./thick. 3 mm
215 x 190 mm

Art. 1535/14
grezzo/unpainted

Art. 1534/14
verniciato/painted



spess./thick. 3 mm
245 x 240 mm

Art. 1535/15
grezzo/unpainted

Art. 1534/15
verniciato/painted



spess./thick. 3 mm
205 x 245 mm

Art. 1535/16
grezzo/unpainted

Art. 1534/16
verniciato/painted





spess./thick. 3 mm
210 x 220 mm

Art. 1535/17
grezzo/unpainted

Art. 1534/17
verniciato/painted



spess./thick. 3 mm
190 x 240 mm

Art. 1535/18
grezzo/unpainted

Art. 1534/18
verniciato/painted



spess./thick. 3 mm
Ø 245 mm

Art. 1535/19
grezzo/unpainted

Art. 1534/19
verniciato/painted



spess./thick. 3 mm
230 x 250 mm

Art. 1535/20
grezzo/unpainted

Art. 1534/20
verniciato/painted



spess./thick. 3 mm
240 x 140 mm

Art. 1535/21
grezzo/unpainted

Art. 1534/21
verniciato/painted



spess./thick. 3 mm
230 x 230 mm

Art. 1535/22
grezzo/unpainted

Art. 1534/22
verniciato/painted



spess./thick. 3 mm
160 x 250 mm

Art. 1535/23
grezzo/unpainted

Art. 1534/23
verniciato/painted



spess./thick. 3 mm
160 x 250 mm

Art. 1535/24
grezzo/unpainted

Art. 1534/24
verniciato/painted



Art. 156/A/7
5 x 5 mm
Ø 35 mm

Art. 156/A/8
5 x 5 mm
Ø 40 mm

Art. 156/A/9
4,5 x 4,5 mm
19 x 50 mm

Art. 156/A/10
5 x 5 mm
15 x 35 mm

Art. 156/A/11
3,5 x 3,5 mm
12 x 40 mm

Art. 156/A/12
3,8 x 3,8 mm
9 x 28 mm

Le misure si riferiscono all'interno della maglia / Size refer to the inside width of the link
LUNGHEZZA delle CATENE = 10.000 mm (10 mt.) / CHAIN LONG = 10.000 mm (10 mt.)



Art. 6318/I - L 3250 mm - H max 2650 mm



Art. 6340/I - L 3240 mm - H max 2660 mm





ARTEFERRO

Art. 6346/I - L 3260 mm - H max 2855 mm



ARTEFERRO

Art. 6344/I - L 3240 mm - H max 2500 mm





Art. 6322/I - L 3240 mm - H max 2490 mm



Art. 6324/I - L 3240 mm - H max 2500 mm





Art. 6320/I - L 1152 mm - H max 1960 mm



Art. 6321/I - L 1120 mm - H max 2490 mm



Art. 6326/I - L 1350 mm - H max 2380 mm



Art. 6327/I - L 1240 mm - H max 2528 mm

ELEMENTI VARI - VARIOUS ELEMENTS



Art. 6343/I - L 1350 mm - H max 2380 mm



Art. 6342/I - L 1050 mm - H max 2300 mm



Art. 6348/I - L 1240 mm - H max 2460 mm



Art. 6349/I - L 1050 mm - H max 2585 mm



L 1500 mm

Art. 6352/1

H 800 mm

Art. 6352/2

H 1000 mm



L 1500 mm

Art. 6353/1

H 800 mm

Art. 6353/2

H 1000 mm



L 1500 mm

Art. 6354/1

H 800 mm

Art. 6354/2

H 1000 mm

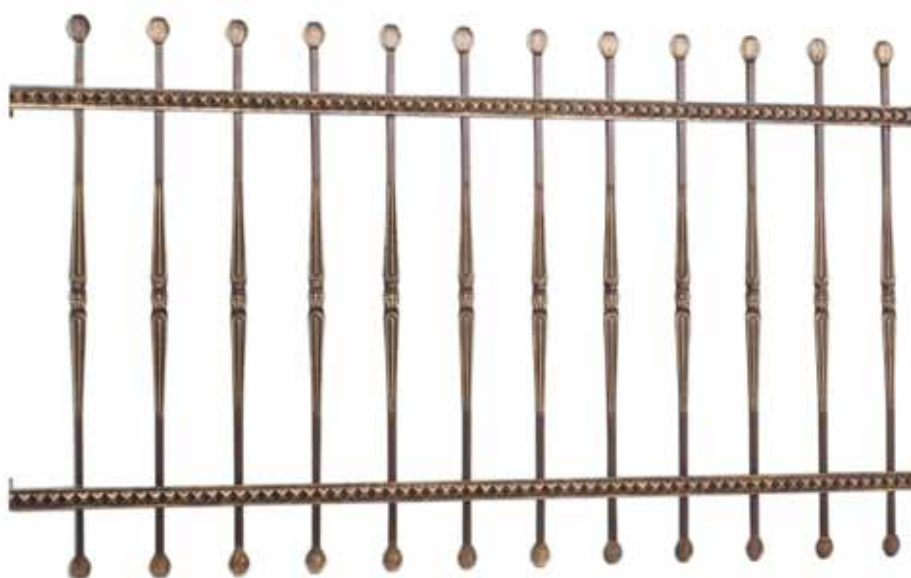



L 1500 mm

Art. 6356/1

H 800 mm

Art. 6356/2

H 1000 mm



L 1500 mm

Art. 6355/1

H 800 mm

Art. 6355/2

H 1000 mm

MONTANTI per PANNELLI MODULARI per RECINZIONI
NEWEL POSTS for MODULAR PANELS for FENCES



Per Pannelli/for panels H 800 mm

Art. 6356/3

H 1000 mm



Per Pannelli/for panels H 800 mm

Art. 6355/3

H 1000 mm



Per Pannelli/for panels H 800 mm

Art. 6352/3

H 1000 mm

Per Pannelli/for panels H 1000 mm

Art. 6356/4

H 1200 mm

Per Pannelli/for panels H 1000 mm

Art. 6355/4

H 1200 mm

Per Pannelli/for panels H 1000 mm

Art. 6352/4

H 1200 mm



Tondo Ø 22 mm a corteccia
Round iron dia 22 mm three effect

Tubo dia 22 mm - liscio
Round Tube iron dia 22 mm



L 1300 mm	Art. 889/1	Art. 889/2
L 1800 mm	Art. 889/3	Art. 889/4
L 2300 mm	Art. 889/5	Art. 889/6



Tondo Ø 22 mm a corteccia
Round iron dia 22 mm three effect

Tubo dia 22 mm - liscio
Round Tube iron dia 22 mm



L 1270 mm	Art. 889/8	Art. 889/7
L 1770 mm	Art. 889/10	Art. 889/9
L 2270 mm	Art. 889/12	Art. 889/11



Tondo Ø 22 mm a corteccia
Round iron dia 22 mm three effect

Tubo dia 22 mm - liscio
Round Tube iron dia 22 mm



L 1210 mm	Art. 889/13	Art. 889/14
L 1710 mm	Art. 889/15	Art. 889/16
L 2210 mm	Art. 889/17	Art. 889/18



Tondo Ø 22 mm a corteccia
Round iron dia 22 mm three effect

Tubo dia 22 mm - liscio
Round Tube iron dia 22 mm



L 1210 mm	Art. 889/20	Art. 889/19
L 1710 mm	Art. 889/22	Art. 889/21
L 2210 mm	Art. 889/24	Art. 889/23



Tondo Ø 22 mm a corteccia
Round iron dia 22 mm three effect

Tubo dia 22 mm - liscio
Round Tube iron dia 22 mm



L 1190 mm	Art. 889/25	Art. 889/26
L 1690 mm	Art. 889/27	Art. 889/28
L 2190 mm	Art. 889/29	Art. 889/30



Tondo Ø 22 mm a corteccia
Round iron dia 22 mm three effect

Tubo dia 22 mm - liscio
Round Tube iron dia 22 mm



L 1140 mm	Art. 889/32	Art. 889/31
L 1640 mm	Art. 889/34	Art. 889/33
L 2140 mm	Art. 889/36	Art. 889/35



Tondo Ø 22 mm a corteccia
Round iron dia 22 mm three effect

Tubo dia 22 mm - liscio
Round Tube iron dia 22 mm



L 1080 mm	Art. 889/37	Art. 889/38
L 1580 mm	Art. 889/39	Art. 889/40
L 2080 mm	Art. 889/41	Art. 889/42



Art. 885/1
 \square 20 x 4 mm
 155 x 120 mm



Art. 885/3
 \square 20 x 4 mm
 210 x 190 mm



Art. 885/4
 \square 25 x 3 mm
 230 x 180 mm



Art. 885/6
 \square 18 x 5 mm
 205 x 235 mm

Art. 885/2
 \square 20 x 4 mm
 205 x 150 mm

Art. 885/5
 \square 25 x 3 mm
 165 x 295 mm



Art. 885/7
 \square 20 x 8 mm
 310 x 240 mm



Art. 886/3
 \square 20 x 8 mm
 290 x 235 mm



Art. 886/1
 \square 20 x 4 mm
 245 x 220 mm



Art. 886/2
 \square 20 x 4 mm
 215 x 216 mm



Art. 886/4
 \square 12 x 12 mm
 215 x 255 mm

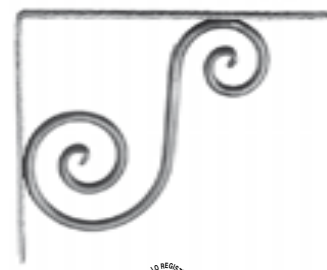

Art. 885/8
 \square 20 x 4 mm
 150 x 200 mm



Art. 1470/7
 \square 75 x 3 mm
 230 x 300 mm



Art. 1470/6
 \square 75 x 3 mm
 240 x 300 mm



Art. 1470/5
 \square 75 x 3 mm
 290 x 300 mm



Art. 1470/4
 \square 75 x 3 mm
 340 x 520 mm



Art. 1470/3
 \square 75 x 3 mm
 330 x 520 mm



Art. 1469/1
 \square 25 x 6 mm
 440 x 260 mm
 fessura/slit 6 mm



ARTEFERRO

Art. 1470/1

☐ 16 x 8 mm
930 x 830 mm
Piatto di supporto
Support section
☐ 40 x 6 mm

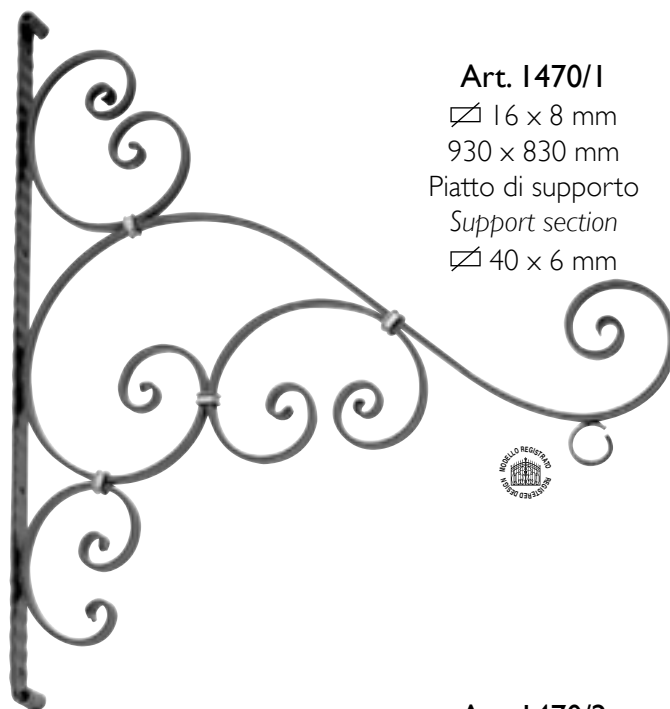

Art. 1470/2

☐ 16 x 8 mm
620 x 760 mm
Piatto di supporto
Support section
☐ 40 x 6 mm



Art. 200/2
470 x 520 mm

Portata
Carry well
kg 100 circa



Art. 902/6

grezzo/unpainted

Art. 10333/1

verniciato/unpainted

☐ 12 x 12 mm
450 x 510 mm



Art. 902/4

grezzo/unpainted

Art. 10520/1

verniciato/unpainted

☐ 14 x 14 mm
450 x 510 mm



Art. 170/8
450 x 35 mm

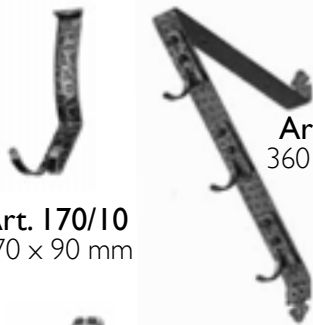

Art. 170/10
170 x 90 mm

Art. 170/9
360 x 35 mm



Art. 170/11
80 x 40 mm



Art. 170/12
170 x 105 mm



Art. 838/6
180 x 100 mm



Art. 838/7
130 x 110 mm



Art. 838/5
240 x 120 mm



Art. 168/1
300 x 60 mm



Portacandela
Candle Holder

Art. 10437/1
H 190 mm
base Ø 90 mm

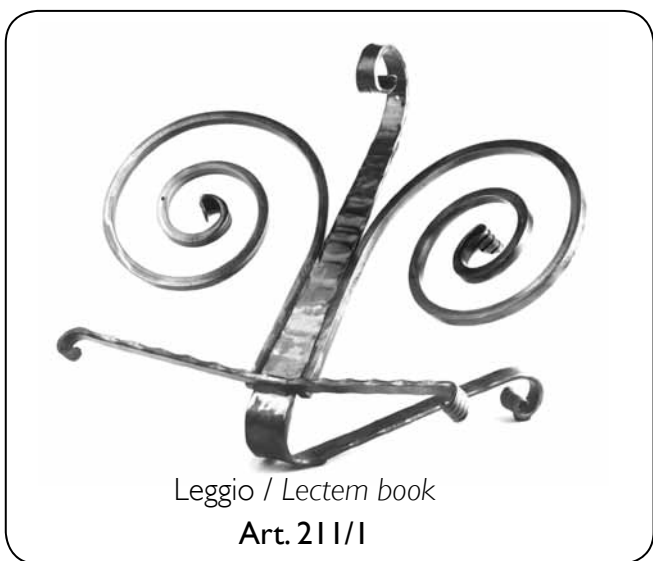

Leggio / Lectem book

Art. 211/1



Art. 1540/6
110 x 105 mm
spess./thick. 3 mm



110 x 105 mm
spess./thick. 3 mm

Art. 1540/7
per n. 2 barre/bars
12 x 6 mm

Art. 1540/8
per n. 3 barre/bars
12 x 6 mm

Art. 1540/9
per n. 4 barre/bars
12 x 6 mm

Art. 10539/1
H 1250 mm
tubo-tube Ø 50 mm



Art. 1540/1
H 530 mm
tubo-tube Ø 50 mm

20 x 20 mm
base Ø 35 mm

Art. 888/2
H 610 mm

Art. 888/3
H 365 mm



Art. 10455/1
H 600 mm
L 1020 mm
P 530 mm



Art. 213/2
200 x 790 mm

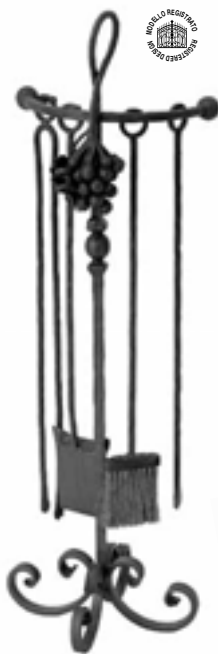

Art. 10472/1
810 x 260 mm



Art. 213/3
230 x 490 x 250 mm



Art. 10473/1
380 x 490 mm



Art. 213/4
200 x 510 x 400 mm



Art. 10473/2
520 x 610 mm



Art. 213/1
360 x 430 mm



Art. 10472/2
530 x 420 x 260 mm



Art. 10474/1
550 x 900 mm



Art. 10475/1
390 x 510 x 410 mm



Art. 10477/2
620 x 420 x 200 mm



Art. 10475/2
480 x 520 x 310 mm



Art. 10477/1
480 x 380 x 360 mm

ELEMENTI VARI - VARIOUS ELEMENTS



Art. 1471/3006/0

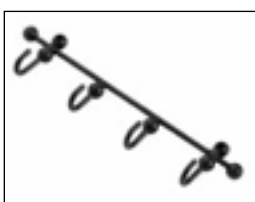

1471/3006/1

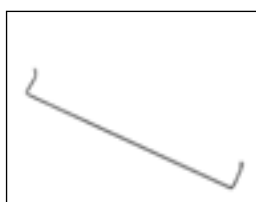

1471/3006/2

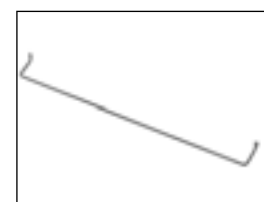

1471/3006/3

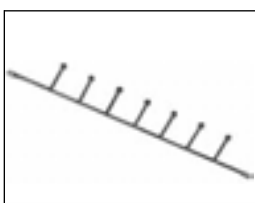

1471/3006/4

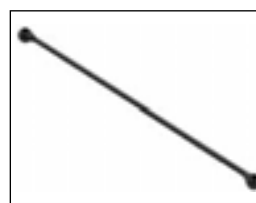

1471/3006/5



1471/3006/6



1471/3006/7



1471/3006/8

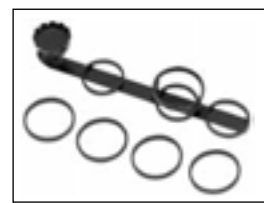

1471/3006/9

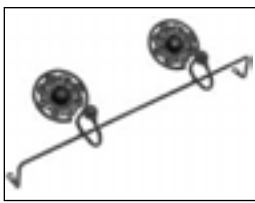

1471/3006/10

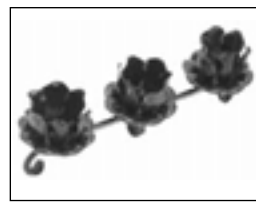

1471/3006/11

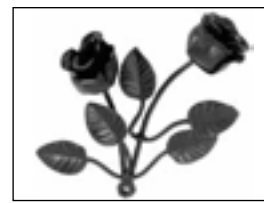

1471/3006/12



1471/3006/13

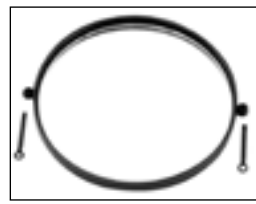

1471/3006/14



1471/3006/15

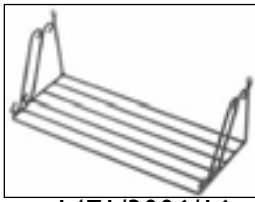

1471/3006/16

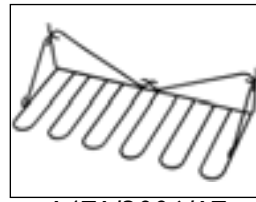

1471/3006/17

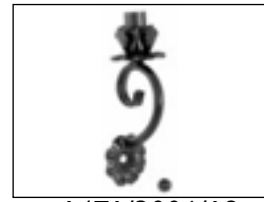

1471/3006/18



1471/3006/19

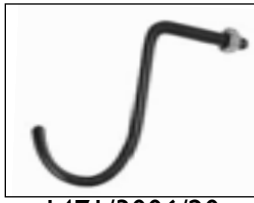

1471/3006/20



1471/3006/21



1471/3006/22

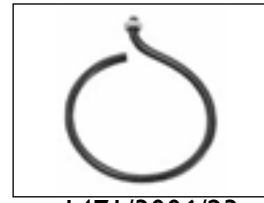

1471/3006/23



1471/3006/24



1471/3006/25



1471/3006/26



1471/3006/27



1471/3006/28

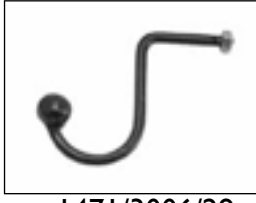

1471/3006/29

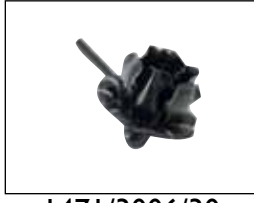

1471/3006/30

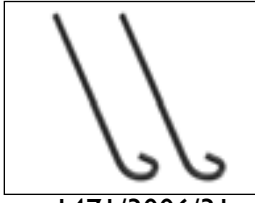

1471/3006/31



1471/3006/32



1471/3006/33



OTTONE E BRONZO - BRASS AND BRONZE

COMPENDIUM 2011

Art. 779/5
Art. 779/6



Art. 790/7
 Ø 10 mm
 H 220 mm
 L 120 mm



Art. 790/8
 Ø 10 mm
 H 290 mm
 L 120 mm



Art. 790/9
 Ø 10 mm
 H 360 mm
 L 120 mm



Art. 790/10
 Ø 10 mm
 H 360 mm
 L 120 mm



Art. 160/L/6
 12 x 4 mm
 Ø 350 mm



Art. 160/L/7
 Ø 265 mm
 6 x 6 mm



ARTEFERRO



Art. 160/I/5 Φ 16 x 16 mm H 830 mm
Art. 160/I/6 Φ 12 x 12 mm H 830 mm
Art. 160/I/1 Φ 12 x 12 mm H 830 mm L 70 mm
Art. 160/I/2 Φ 12 x 12 mm H 830 mm L 70 mm

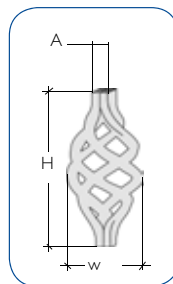

con foro filettato
with threaded hole

Cod.art. Art.no.	Φ /dia.	H	A
160/L/1	70 mm	150 mm	12 x 12 mm
160/L/2	70 mm	150 mm	16 x 16 mm
160/L/3	75 mm	160 mm	20 x 20 mm



Art. 160/I/4 Φ 12 x 12 mm H 830 mm L 70 mm
Art. 160/I/3 Φ 12 x 12 mm H 830 mm L 70 mm

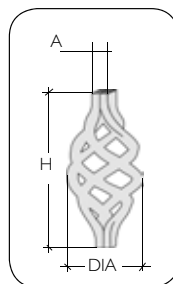

con foro filettato
with threaded hole

Cod.art. Art.no.	Φ /dia.	H	A
160/L/5	70 mm	150 mm	12 x 12 mm
160/L/4	70 mm	150 mm	15 x 15 mm

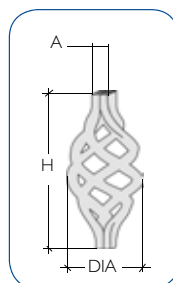

Cod.art. Art.no.	Φ /dia.	H	A
1466/12	65 mm	140 mm	12 x 12 mm
1466/11	80 mm	150 mm	16 x 16 mm
1466/10	90 mm	170 mm	20 x 20 mm

Art. 160/A/1 Φ 30 mm H 360 mm Tubo/Tube
Art. 160/A/2 Φ 40 mm H 360 mm Tubo/Tube
Art. 160/A/3 Φ 30 mm H 360 mm Tubo/Tube

Art. 1464/11
Ø 53 x 10 mm
L 3000 mm



Art. 1465/18

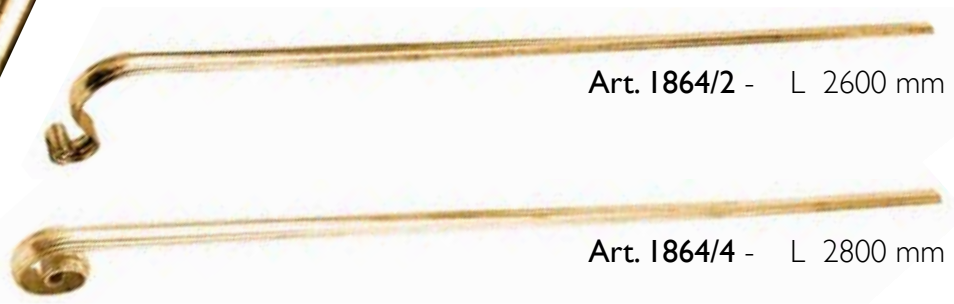

Art. 1864/2 - L 2600 mm

Art. 1864/4 - L 2800 mm

Art. 1464/12
Ø 53 x 10 mm
L 3000 mm



Art. 1465/17

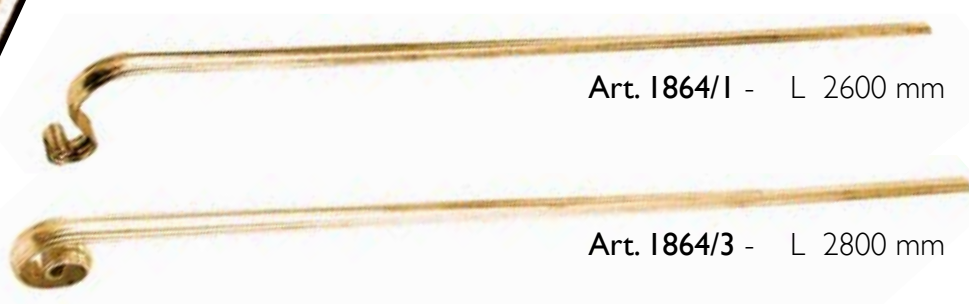

Art. 1864/1 - L 2600 mm

Art. 1864/3 - L 2800 mm

Art. 116/B/1
Ø 58 x 14 mm
L 2000 mm
Lucidato
polished

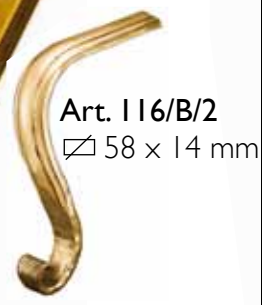

Art. 116/B/2
Ø 58 x 14 mm

Art. 1464/34
Ø 58 x 14 mm
L 2000 mm
grezzo - raw

Art. 1464/15
Ø 58 x 22 mm
L 2000 mm

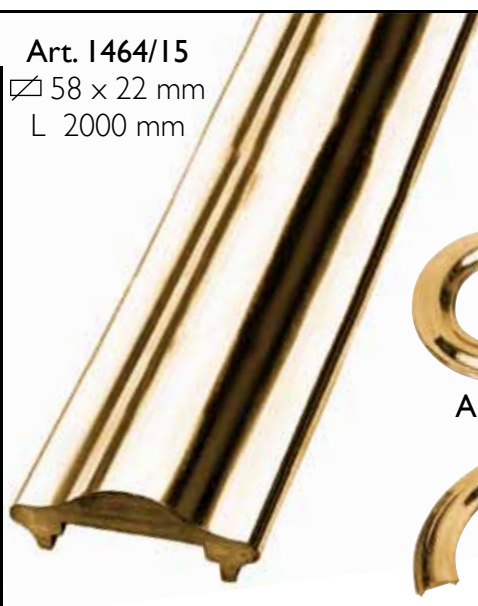

Art. 1465/21



Art. 1465/19



Art. 1465/20



Art. 1465/6



Art. 1465/14



Art. 1464/6
40 x 8 mm
L 3000 mm

Art. 1864/10 - L 2600 mm



Art. 1864/18 - L 2800 mm



Art. 1465/5



Art. 1465/13

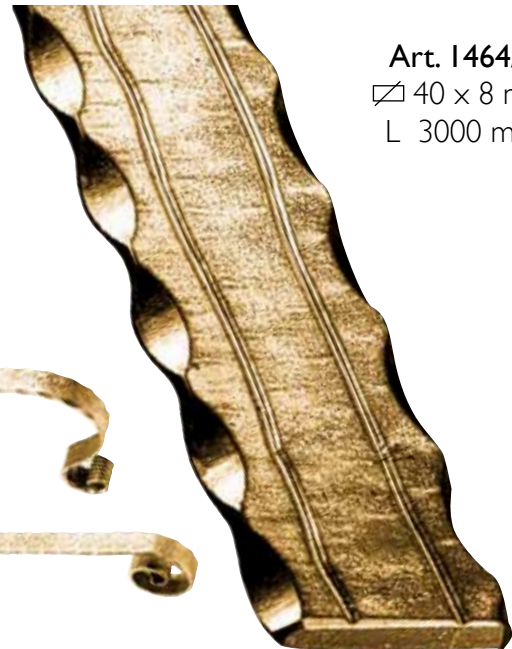

Art. 1464/5
40 x 8 mm
L 3000 mm

Art. 1864/9 - L 2600 mm



Art. 1864/17 - L 2800 mm



OTTONE e BRONZO - BRASS and BRONZE

Art. 1464/8
40 x 8 mm
L 3000 mm



Art. 1465/16



Art. 1465/8

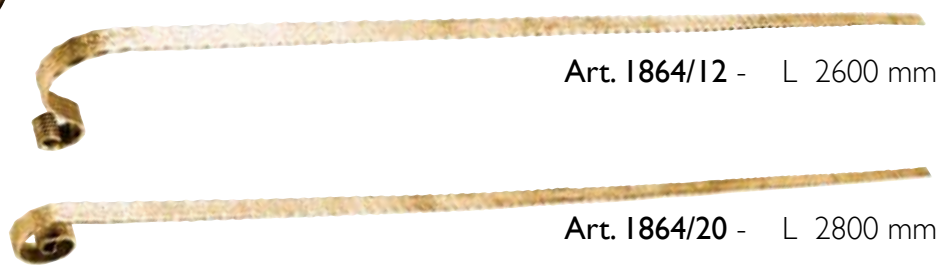

Art. 1864/12 - L 2600 mm

Art. 1864/20 - L 2800 mm

Art. 1464/2
40 x 8 mm
L 3000 mm



Art. 1465/10



Art. 1465/2

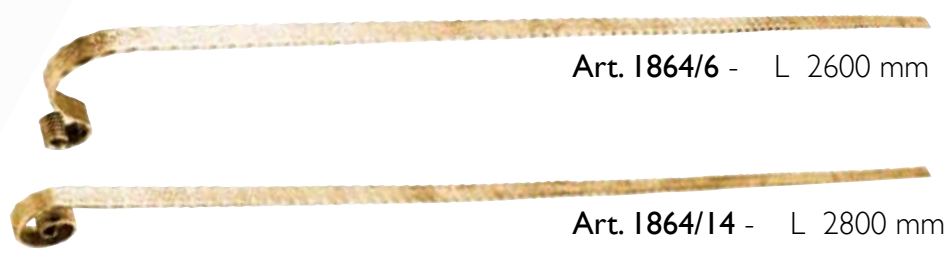

Art. 1864/6 - L 2600 mm

Art. 1864/14 - L 2800 mm

Art. 1464/4
40 x 8 mm
L 3000 mm



Art. 1465/12



Art. 1465/4

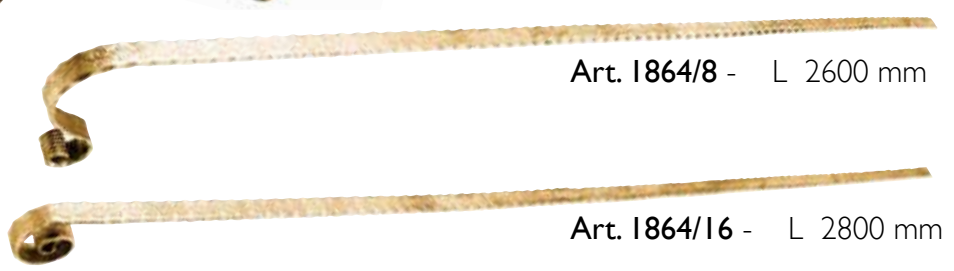

Art. 1864/8 - L 2600 mm

Art. 1864/16 - L 2800 mm



Art. 1465/1



Art. 1465/9



Art. 1464/1
40 x 8 mm
L 3000 mm



Art. 1864/5 - L 2600 mm



Art. 1864/13 - L 2800 mm



Art. 1465/3



Art. 1465/11



Art. 1464/3
40 x 8 mm
L 3000 mm



Art. 1864/7 - L 2600 mm



Art. 1864/15 - L 2800 mm



Art. 1465/7



Art. 1465/15



Art. 1464/7
40 x 8 mm
L 3000 mm



Art. 1864/11 - L 2600 mm



Art. 1864/19 - L 2800 mm



Art. I464/10
 \square 30 x 8 mm
 L 3000 mm



Art. I464/9
 \square 30 x 8 mm
 L 3000 mm



Art. I464/33
 \square 14 x 4,5 mm
 L 4000 mm

tubo/fune attorcigliata
 tube/ twisted rope



Tube/Tube
Art. 790/5
 \varnothing 20 mm
 L 3000 mm
Art. 790/6
 \varnothing 30 mm
 L 3000 mm



Art. I464/13
 \square 14 x 4,5 mm
 L 4000 mm



Art. I464/14
 \square 14 x 4,5 mm
 L 4000 mm

- Art. I464/16** - per / for 2 barre / bars \square 20 x 6 mm
- Art. I464/17** - per / for 2 barre / bars \square 12 x 6 mm
- Art. I464/18** - per / for 3 barre / bars \square 12 x 6 mm
- Art. I464/19** - per / for 4 barre / bars \square 12 x 6 mm
- Art. I464/20** - per / for 6 barre / bars \square 12 x 6 mm
- Art. I464/21** - per / for 2 barre / bars \square 10 x 5 mm
- Art. I464/22** - per / for 2 barre / bars \varnothing 8 mm
- Art. I464/23** - per / for 3 barre / bars \varnothing 8 mm
- Art. I464/24** - per / for 4 barre / bars \varnothing 8 mm
- Art. I464/25** - per / for 2 barre / bars \varnothing 10 mm
- Art. I464/26** - per / for 3 barre / bars \varnothing 10 mm
- Art. I464/27** - per / for 1 barre / bars \varnothing 14 mm
- Art. I464/28** - per / for 1 barre / bars \varnothing 25 mm

- Art. I464/29** - per / for 2 barre / bars \square 12 x 6 mm
- Art. I464/30** - per / for 3 barre / bars \square 12 x 6 mm
- Art. I464/31** - per / for 4 barre / bars \square 12 x 6 mm
- Art. I464/32** - per / for 6 barre / bars \square 12 x 6 mm



ARTEFERRO



Art. 160/D/10
35 x 35 mm
H 20 mm
Foro/Hole
Φ 14 mm



Art. 160/D/11
38 x 38 mm
H 40 mm
Foro/Hole
Φ 14 mm



Art. 160/D/7
Ø 40 mm
H 20 mm
Foro/Hole
Ø 16 mm



Art. 160/B/6
Ø 70 mm
H 65 mm
Foro/Hole
Ø 40 mm



Art. 160/B/7
Ø 39 mm
H 60 mm
Foro/Hole
Ø 16,5 mm



Art. 744/3
Ø 50 mm
H 70 mm
Foro/Hole
Ø 30 mm



Art. 160/D/1
Ø 55 mm
Foro/Hole Ø 14 mm



Art. 744/2
Ø 79 mm
H 130 mm
Foro/Hole Ø 32 mm



Ø 29 mm

Art. 160/B/2
Foro/Hole Ø 12 mm



Art. 1466/4
H 35 mm



Art. 1466/7
H 25 mm



Art. 744/1
Ø 45 mm
H 60 mm
Foro/Hole Ø 16 mm

Art. 160/D/2
Ø 55 mm

Foro/Hole Ø 16 mm

Art. 160/D/3
Ø 55 mm

Foro/Hole Ø 20 mm

Art. 160/D/4
Ø 55 mm

Foro/Hole Φ 14 mm

Art. 160/D/5
Ø 55 mm

Foro/Hole Φ 16 mm

Art. 160/D/6
Ø 55 mm

Foro/Hole Φ 20 mm

Borchia in tubo
Bush from brass tube



Art. 160/B/1
Ø 40 mm
H 105 mm
Foro/Hole Ø 16 mm



Art. 160/D/8
Ø 40 mm
H 30 mm
Foro/Hole Ø 16 mm



Art. 160/D/9
Ø 40 mm
H 45 mm
Foro/Hole Ø 16 mm



Art. 160/D/14
Ø 40 mm
H 75 mm
Foro/Hole Ø 16 mm



Art. 160/D/12
Ø 40 mm
H 135 mm
Foro/Hole Ø 16 mm

Art. 160/D/13
Ø 40 mm
H 135 mm
Foro/Hole Ø 20 mm

Art. 160/D/15
Ø 40 mm
H 75 mm
Foro/Hole Ø 20 mm



Art. 744/4
35 x 35 mm
H 93 mm
Foro/Hole Ø 16 mm



Art. 744/5
Ø 59 mm
H 150 mm
Foro/Hole Ø 12 mm



Art. 744/6
Ø 47 mm
H 175 mm
Foro/Hole Ø 14 mm



Art. 744/7
Ø 45 mm
H 160 mm
Foro/Hole Ø 16 mm



Art. 160/42
Ø 75 mm
H 185 mm
Foro/Hole Ø 22 mm



Art. 744/8
Ø 40 mm
H 146 mm
Foro/Hole Ø 16,5 mm



	H 60 mm	H 60 mm	H 60 mm	H 40 mm	H 26 mm	H 26 mm
	Cod.art. Art.no.	Cod.art. Art.no.	Cod.art. Art.no.	Cod.art. Art.no.	Cod.art. Art.no.	Cod.art. Art.no.
Foro/Hole Ø 10 mm	161/1 Ø 28 mm	161/6 Ø 28 mm	161/11 Ø 28 mm	161/16 Ø 18 mm	161/21 Ø 28 mm	161/31 Ø 28 mm
Foro/Hole Ø 12 mm	161/2 Ø 30 mm	161/7 Ø 30 mm	161/12 Ø 30 mm	161/17 Ø 20 mm	161/22 Ø 30 mm	161/32 Ø 30 mm
Foro/Hole Ø 14 mm	161/3 Ø 32 mm	161/8 Ø 32 mm	161/13 Ø 32 mm	161/18 Ø 22 mm	161/23 Ø 32 mm	161/33 Ø 32 mm
Foro/Hole Ø 16 mm	161/4 Ø 34 mm	161/9 Ø 34 mm	161/14 Ø 34 mm	161/19 Ø 24 mm	161/24 Ø 34 mm	161/34 Ø 34 mm
Foro/Hole Ø 18 mm	161/5 Ø 36 mm	161/10 Ø 36 mm	161/15 Ø 36 mm	161/20 Ø 26 mm	161/25 Ø 36 mm	161/35 Ø 36 mm



Art. 743/5
Ø 48 mm
H 47 mm
Foro/Hole Ø 10 mm



Art. 743/4
Ø 49 mm
H 48 mm
Foro/Hole Ø 10 mm

Art. 743/6
Ø 40 mm
H 37 mm
Foro/Hole Ø 10 mm



Art. 743/2
Ø 45 mm
H 55 mm
Foro/Hole Ø 10 mm

Art. 743/7
Ø 30 mm
H 28 mm
Foro/Hole Ø 10 mm

Art. 743/10
Ø 35 mm
H 47 mm
Foro/Hole Ø 10 mm



Art. 743/8
Ø 45 mm
H 100 mm
Foro/Hole Ø 10 mm



Art. 743/9
Ø 35 mm
H 70 mm
Foro/Hole Ø 10 mm

Art. 743/1
Ø 50 mm
H 51 mm
Foro/Hole Ø 10 mm

SFERE VUOTE / HOLLOW SPHERES

non lucidate / unpolished

Spessore/Thickness 1 mm - Foro/Hole Ø 10 mm



	Articolo/Item #
Ø 50 mm	1467/1
Ø 60 mm	1467/2
Ø 75 mm	1467/3
Ø 85 mm	1467/4
Ø 100 mm	1467/5
Ø 120 mm	1467/6
Ø 150 mm	1467/7

SEMISFERE VUOTE / HALF HOLLOW SPHERES

non lucidate / unpolished

Spessore/Thickness 1 mm - Foro/Hole Ø 10 mm



Altezza/Height	Cod.art. Art.no.	Cod.art. Art.no.
26 mm	1468/6 Ø 50 mm	1468/1 Ø 52 mm
29 mm	1468/7 Ø 60 mm	1468/2 Ø 62 mm
39 mm	1468/8 Ø 75 mm	1468/3 Ø 77 mm
44 mm	1468/9 Ø 85 mm	1468/4 Ø 87 mm
50 mm	1468/10 Ø 100 mm	1468/5 Ø 102 mm



ARTEFERRO



Art. 743/3
 Ø 30 mm
 H 26 mm
 Foro/Hole Ø 10 mm



Art. 803/5
 65 x 65 mm
 Spess./Thickness 6 mm
Art. 803/4
 95 x 95 mm
 Spess./Thickness 10 mm



Art. 795/11
 50 x 50 mm
 Foro/Hole Ø 20 mm
Art. 795/12
 60 x 60 mm
 Foro/Hole Ø 20 mm



Art. 796/1
 H 170 mm
 Ø 16 mm
Art. 796/2
 H 140 mm
 Ø 14 mm



Art. 160/C/9
 L 70 mm
 H 160 mm

Foro/Hole Ø 16 mm

Art. 160/C/10
 L 70 mm
 H 160 mm

Foro/Hole Ø 16 mm



Art. 160/C/7
 L 65 mm
 H 185 mm

Foro/Hole Ø 16 mm

Art. 160/C/8
 L 65 mm
 H 185 mm

Foro/Hole Ø 16 mm



Art. 796/5
 H 130 mm
 Ø 13 mm

Art. 796/6
 H 160 mm
 Ø 16 mm

Art. 796/7
 H 195 mm
 Ø 19 mm



Art. 796/3
 H 125 mm
 Ø 12 mm

Art. 796/4
 H 160 mm
 Ø 15 mm



Art. 795/10
 L 70 mm
 H 120 mm

Filetto/Thread 6 MA



Art. 795/9
 L 68 mm
 H 75 mm

Filetto/Thread 6 MA



Art. 795/8
 L 70 mm
 H 120 mm

Filetto/Thread 6 MA



filetto-thread 4MA
Art. 795/7
 L 70 mm
 H 85 mm

Spess./Thickness 3 mm



filetto-thread 4MA
Art. 795/6
 L 70 mm
 H 90 mm

Spess./Thickness 3 mm



Art. 728/1
 H 295 mm
 Base Ø 35 mm





Art. 1463/6
100 x 100 mm
Spess./Thickness 8 mm



Art. 1463/7
80 x 80 mm
Spess./Thickness 8 mm



Art. 1463/8
80 x 80 mm
Spess./Thickness 8 mm



Art. 1463/9
70 x 70 mm
Spess./Thickness 4 mm
Foro/Hole \varnothing 13 mm



Art. 1463/10
75 x 75 mm
Spess./Thickness 4 mm
Foro/Hole \varnothing 13 mm

BASE in FUSIONE d'OTTONE - CAST BRASS BASES



Cod.art. Art.no.	Base	Altezza/Height
1865/1	42 x 42 mm	33 mm
1865/2	60 x 60 mm	46 mm
1865/3	74 x 74 mm	58 mm
1865/4	90 x 90 mm	71 mm
1865/5	112 x 112 mm	89 mm



ARTEFERRO



Cod.art. Art.no.	160/43	160/44	160/45	160/46	815/1	815/2
Ø/diameter	80 mm	96 mm	56 mm	78 mm	60 mm	88 mm
Altezza/Height	130 mm	93 mm	117 mm	55 mm	82 mm	55 mm
Filetto/Thread	12 MA	12 MA	12 MA	12 MA	14 MA	12 MA
Base	Ø 40 mm	Ø 40 mm	Ø 40 mm	Ø 40 mm	Ø 42 mm	Ø 27 mm



Cod.art. Art.no.	815/3	816/1	816/3	816/5	816/4	1466/3
Ø/diameter	52 mm	57 mm	80 mm	43 mm	70 mm	40 mm
Altezza/Height	70 mm	85 mm	120 mm	52 mm	116 mm	54 mm
Filetto/Thread	10 MA	6 MA	6 MA	10 MA	14 MA	14 MA
Base	Ø 29 mm	Ø 30 mm	Ø 35 mm	Ø 40 mm	Ø 49 mm	Ø 33 mm



Cod.art. Art.no.	816/2	1466/1	1466/2	160/C/11	160/C/12
Ø/diameter	56 mm	80 mm	50 mm	60 mm	55 mm
Altezza/Height	80 mm	72 mm	72 mm	165 mm	105 mm
Filetto/Thread	6 MA	12 MA	14 MA	-	-
Base	Ø 30 mm	Ø 38 mm	Ø 40 mm	Ø 42 mm	Ø 32 mm



Cod.art. Art.no.	Ø/diameter	Filetto Thread
816/6	18 mm	4 MA
816/7	25 mm	4 MA
816/8	30 MA	4 MA



Cod.art. Art.no.	Ø/diameter	Filetto Thread
816/9	25 mm	8 MA
816/10	30 mm	8 MA
816/11	35 MA	10 MA
816/12	40 MA	10 MA
816/13	45 MA	10 MA
816/14	50 MA	10 MA
816/15	60 MA	12 MA
816/16	70 MA	12 MA

POMOLI in VETRO di MURANO - MURANO GLASS KNOBS



Cod.art./Art.no.	817/1	817/2	817/3	817/4
Ø/diameter	50 mm	65 mm	65 mm	65 mm
Filetto/Thread	10 MA	6 MA	6 MA	6 MA
Base	-	Ø 27 mm	Ø 27 mm	Ø 27 mm

Opaco/Opaque Glass



Lucido/Shiny



Cod.art./Art.no.	818/2	818/1	818/3	818/4
Ø/diameter	67 mm	67 mm	67 mm	67 mm
Filetto/Thread	6 MA	6 MA	6 MA	6 MA
Base	Ø 28 mm	Ø 28 mm	Ø 28 mm	Ø 28 mm

ARTEFERRO



Art. 160/E/6
Ø 80 mm



Art. 160/E/7
H 30 mm
Base 15 mm
Filetto/Thread 5 MA



Art. 160/E/8
Ø 35 mm
Filetto/Thread 5 MA



Art. 705/2
H 20 mm
Ø 46 mm
Filetto/Thread M3
Spess./Thickn. 0,3 mm



Art. 705/4
H 45 mm
Ø 55 mm
Filetto/Thread M3
Spess./Thickn. 0,3 mm



Art. 705/6
H 36 mm
Ø 40 mm
Filetto/Thread M3
Spess./Thickn. 0,3 mm



Art. 705/16
H 58 mm
Ø 70 mm
Spess./Thickn. 0,3 mm



Art. 705/18
H 42 mm
Ø 46 mm
Spess./Thickn. 0,3 mm



Art. 705/8
H 16 mm
Ø 45 mm
Filetto/Thread M3
Spess./Thickn. 0,3 mm



Art. 705/10
H 15 mm
Ø 43 mm
Filetto/Thread M3
Spess./Thickn. 0,3 mm



Art. 705/12
H 12 mm
Ø 45 mm
Filetto/Thread M3
Spess./Thickn. 0,3 mm



Art. 705/14
H 10 mm
Ø 45 mm
Filetto/Thread M3
Spess./Thickn. 0,3 mm



Art. 160/E/9
H 260 mm



Art. 160/G/B
H 360 mm
L 55 mm
Mezzo guscio
Half shell



Art. 160/G/A
H 270 mm
L 55 mm
Mezzo guscio
Half shell



Art. 160/G/C
H 370 mm
L 110 mm



Art. 160/G/D
H 360 mm
L 250 mm
Mezzo guscio
Half shell



Art. 160/G/E
H 340 mm
L 250 mm
Mezzo guscio
Half shell



Art. 160/G/F
H 360 mm
L 150 mm
Mezzo guscio
Half shell



Art. 160/G/G
H 260 mm
L 220 mm
Mezzo guscio
Half shell



Art. 160/G/H
H 310 mm
L 235 mm
Mezzo guscio
Half shell



Art. 160/H/A
H 340 mm
L 75 mm



Art. 160/H/C
H 135 mm
L 75 mm



Art. 160/H/B
H 105 mm
L 45 mm



Art. 160/H/L
Ø 18 mm



Art. 160/H/M
Ø 105 mm



Art. 160/H/N
Ø 97 mm
Mezzo guscio-Half shell



Art. 160/H/O
H 35 mm
L 44 mm



Art. 160/H/P
Ø 62 mm
Mezzo guscio-Half shell



Art. 160/H/Q
95 x 95 mm



ARTEFERRO



Art. 160/H/D
H 135 mm
L 95 mm



Art. 160/H/E
H 125 mm
L 90 mm



Art. 160/H/F
H 90 mm
L 35 mm



Art. 160/H/G
H 110 mm
L 40 mm



Art. 160/H/H
H 115 mm
L 60 mm



Art. 160/H/I sx
H 185 mm
L 75 mm



Art. 160/H/I dx
H 185 mm
L 75 mm

Spessore / Thickness 0,3 mm



Art. 704/2
H 136 mm
L 33 mm



Art. 704/4
H 116 mm
L 34 mm



Art. 704/6
H 90 mm
L 32 mm



Art. 704/8
H 85 mm
L 29 mm



Art. 704/10
H 90 mm
L 34 mm



Art. 704/12
H 85 mm
L 31 mm



Art. 706/2
H 65 mm
L 25 mm



Art. 706/4
H 98 mm
L 37 mm



Art. 706/6
H 130 mm
L 50 mm



Art. 706/8
H 50 mm
L 22 mm



Art. 706/10
H 65 mm
L 28 mm



Art. 706/12
H 80 mm
L 34 mm



Art. 706/14
H 110 mm
L 48 mm



Art. 706/16
H 70 mm
L 29 mm



Art. 706/18
H 73 mm
L 22 mm



Art. 706/20
H 45 mm
L 24 mm



Art. 706/22
H 62 mm
L 34 mm



Art. 706/24
H 81 mm
L 41 mm



Art. 707/2
H 41 mm
L 40 mm



Art. 707/6
H 140 mm
L 120 mm



Art. 707/8
H 50 mm
L 100 mm



Art. 707/10
Ø 35 mm



Art. 707/12
H 56 mm
L 34 mm



Art. 707/14
H 56 mm
L 34 mm



Art. 708/2
H 194 mm
L 67 mm



Art. 708/4
H 120 mm
L 38 mm



Art. 708/6
H 140 mm
L 51 mm

Spessore / Thickness 0,3 mm



Art. 708/8 H 285 mm L 55 mm	Art. 708/10 H 148 mm L 27 mm	Art. 708/12 H 152 mm L 105 mm	Art. 708/14 H 152 mm L 105 mm	Art. 708/16 H 110 mm L 35 mm	Art. 708/18 H 110 mm L 35 mm	Art. 709/2 H 60 mm L 49 mm	Art. 709/4 H 36 mm L 30 mm
------------------------------------------	-------------------------------------------	--------------------------------------------	--------------------------------------------	-------------------------------------------	-------------------------------------------	-----------------------------------------	-----------------------------------------



Art. 709/6 H 48 mm L 39 mm	Art. 709/8 H 39 mm L 36 mm	Art. 709/10 H 56 mm L 54 mm	Art. 709/12 H 72 mm L 72 mm	Art. 709/14 H 68 mm L 18 mm	Art. 709/16 H 128 mm L 31 mm	Art. 709/18 H 175 mm L 41 mm	Art. 709/20 H 225 mm L 30 mm	Art. 709/22 H 199 mm L 19 mm
-----------------------------------------	-----------------------------------------	------------------------------------------	------------------------------------------	------------------------------------------	-------------------------------------------	-------------------------------------------	-------------------------------------------	-------------------------------------------



Art. 710/2 H 46 mm Ø 122 mm	Art. 710/4 H 39 mm Ø 100 mm	Art. 710/8 H 45 mm Ø 90 mm
------------------------------------------	------------------------------------------	-----------------------------------------



Art. 710/10 H 40 mm Ø 100 mm	Art. 710/12 H 85 mm Ø 100 mm	Art. 710/14 H 28 mm Ø 100 mm
-------------------------------------------	-------------------------------------------	-------------------------------------------



ARTEFERRO



Art. 789/7 H 85 mm L 95 mm Spess./Thickn. 10 mm	Art. 789/10 H 155 mm L 120 mm Spess./Thickn. 15 mm	Art. 789/2 H 200 mm L 180 mm Spess./Thickn. 15 mm	Art. 789/3 H 260 mm L 175 mm Spess./Thickn. 15 mm	Art. 789/9 H 190 mm L 175 mm Spess./Thickn. 10 mm
-----------------------------------------------------------------	--------------------------------------------------------------------	-------------------------------------------------------------------	-------------------------------------------------------------------	-------------------------------------------------------------------



Art. 789/1 H 140 mm - L 540 mm Spessore/Thickness 25 mm	Art. 789/8 H 60 mm - L 275 mm Spessore/Thickness 10 mm	Art. 789/4 Ø 170 mm Spess./Thickn. 10 mm	Art. 789/5 Ø 170 mm Spess./Thickn. 10 mm	Art. 789/6 H 250 mm L 95 mm Spess./Thickn. 10 mm
----------------------------------------------------------------------	---------------------------------------------------------------------	-------------------------------------------------------	-------------------------------------------------------	------------------------------------------------------------------



Art. 791/1
H 240 mm
L 290 mm
Foro/Hole 30x20 mm
2 gusci / 2 shells



Art. 793/5
H 230 mm
L 115 mm
Foro/Hole 30x20 mm
2 gusci / 2 shells



Art. 791/2
H 240 mm
L 280 mm
Foro/Hole 30x20 mm
2 gusci / 2 shells



Art. 793/10
H 240 mm
L 130 mm
Foro/Hole 20x15 mm
2 gusci / 2 shells



Art. 791/5
H 155 mm
L 140 mm
Foro/Hole 30x20 mm
2 gusci / 2 shells



Art. 790/1
Ø 65 mm
Spess./Thickn. 3 mm



Art. 790/2
Ø 95 mm
Spess./Thickn. 3 mm



Art. 790/4
H 65 mm
L 65 mm
2 gusci / 2 shells



Art. 791/3
H 120 mm
L 80 mm
Filetto/Thread 6MA
Spess./Thickn. 15 mm



Art. 791/4
H 160 mm
L 120 mm
Filetto/Thread 6MA
Spess./Thickn. 15 mm



Art. 791/6
H 70 mm
L 50 mm
Spess./Thickn. 6 mm



Art. 791/7
H 100 mm
L 65 mm
Spess./Thickn. 6 mm



Art. 791/8
H 68 mm
L 72 mm
Spess./Thickn. 6 mm



Art. 791/9
H 78 mm
L 73 mm
Filetto/Thread 6MA
Spess./Thickn. 15 mm



Art. 793/1
H 95 mm
L 80 mm
Spess./Thickn. 6 mm



Art. 793/2
H 120 mm
L 80 mm
Spess./Thickn. 6 mm



Art. 793/3
H 155 mm
L 110 mm
Spess./Thickn. 5 mm



Art. 795/2
H 230 mm
L 45 mm



Art. 793/7
H 300 mm
L 70 mm



Art. 795/5
H 220 mm
300 x 200 mm
foro-Hole Ø 30 mm



Art. 793/4
H 165 mm
L 35 mm
Spess./Thickn. 5 mm



Art. 795/4
H 180 mm
L 70 mm
Filetto/Thread 6MA



Art. 793/8
H 255 mm
L 100 mm



Art. 795/3
H 130 mm
L 73 mm
Filetto/Thread 6MA



Art. 793/9
H 255 mm
L 100 mm



Art. 795/1
H 130 mm
L 110 mm
Filetto/Thread 6MA



Art. 793/6
H 250 mm
L 90 mm

FOGLIE in OTTONE NON LUCIDATI / UNPOLISHED BRASS LEAVES



Art. 1456/1
H 100 mm
L 160 mm
Ø 12 mm
Spess./Thickn. 4 mm



Art. 1456/2
H 100 mm
L 160 mm
Ø 12 mm
Spess./Thickn. 4 mm



Art. 1456/5
H 80 mm
L 160 mm
Ø 12 mm
Spess./Thickn. 4 mm



Art. 1456/6
H 80 mm
L 160 mm
Ø 12 mm
Spess./Thickn. 4 mm



Art. 1456/7
H 100 mm
L 80 mm
Ø 12 mm
Spess./Thickn. 4 mm



Art. 1456/8
H 100 mm
L 80 mm
Ø 12 mm
Spess./Thickn. 4 mm



Art. 1457/1
H 390 mm
L 155 mm
Spess./Thickn. 4 mm



Art. 1457/2
H 390 mm
L 110 mm
Spess./Thickn. 4 mm



Art. 1457/3
H 360 mm
L 100 mm
Spess./Thickn. 4 mm



Art. 1457/5
H 190 mm
L 45 mm
Spess./Thickn. 4 mm



Art. 1457/6
H 190 mm
L 45 mm
Spess./Thickn. 4 mm



Art. 1458/2
H 200 mm
L 90 mm
Ø 12 mm
Spess./Thickn. 4 mm



Art. 1456/9
H 112 mm
L 70 mm
Ø 12 mm
Spess./Thickn. 4 mm



Art. 1456/10
H 112 mm
L 70 mm
Ø 12 mm
Spess./Thickn. 4 mm



Art. 1458/1
H 140 mm
L 70 mm
Spess./Thickn. 4 mm



Art. 1457/4
H 240 mm
L 77 mm
Ø 12 mm
Spess./Thickn. 4 mm



Art. 1458/3
H 220 mm
L 115 mm
Ø 12 mm
Spess./Thickn. 4 mm



Art. 1458/4
H 250 mm
L 80 mm
Ø 12 mm
Spess./Thickn. 4 mm



Art. 1458/13
H 90 mm
L 65 mm
Ø 12 mm
Spess./Thickn. 4 mm



Art. 1458/14
H 90 mm
L 65 mm
Ø 12 mm
Spess./Thickn. 4 mm



Art. 1456/3
H 100 mm
L 160 mm
Ø 12 mm
Spess./Thickn. 4 mm



Art. 1456/4
H 100 mm
L 160 mm
Ø 12 mm
Spess./Thickn. 4 mm



Art. 1456/11
H 120 mm
L 70 mm
Ø 12 mm
Spess./Thickn. 4 mm



Art. 1456/12
H 120 mm
L 70 mm
Ø 12 mm
Spess./Thickn. 4 mm

FOGLIE in OTTONE NON LUCIDATI / UNPOLISHED BRASS LEAVES



Art. 1458/5
H 160 mm
L 150 mm
Ø 12 mm
Spess./Thickn. 4 mm

Art. 1458/6
H 160 mm
L 150 mm
Ø 12 mm
Spess./Thickn. 4 mm



Art. 1458/7
H 130 mm
L 180 mm
Ø 12 mm
Spess./Thickn. 4 mm

Art. 1458/8
H 130 mm
L 180 mm
Ø 12 mm
Spess./Thickn. 4 mm



Art. 1458/9
H 150 mm
L 180 mm
Ø 12 mm
Spess./Thickn. 4 mm

Art. 1458/10
H 150 mm
L 180 mm
Ø 12 mm
Spess./Thickn. 4 mm



Art. 1458/11
H 120 mm
L 85 mm
Ø 12 mm
Spess./Thickn. 4 mm



Art. 1458/12
H 120 mm
L 85 mm
Ø 12 mm
Spess./Thickn. 4 mm



Art. 1461/3
H 90 mm
L 155 mm
Ø 12 mm
Spess./Thickn. 4 mm



Art. 1461/4
H 90 mm
L 155 mm
Ø 12 mm
Spess./Thickn. 4 mm



Art. 1461/5
H 70 mm
L 160 mm
Ø 12 mm
Spess./Thickn. 4 mm



Art. 1461/6
H 70 mm
L 160 mm
Ø 12 mm
Spess./Thickn. 4 mm



Art. 1460/1
H 400 mm
L 325 mm
Spess./Thickn. 4 mm



Art. 1460/2
H 400 mm
L 325 mm
Spess./Thickn. 4 mm



Art. 1457/7
H 95 mm
L 60 mm
Spess./Thickn. 4 mm



Art. 1462/7
H 110 mm
L 50 mm
Spess./Thickn. 4 mm



Art. 1462/8
H 100 mm
L 115 mm
Spess./Thickn. 4 mm



Art. 1462/1
H 175 mm
L 289 mm
Spess./Thickn. 4 mm



Art. 1462/2
H 140 mm
L 165 mm
Spess./Thickn. 4 mm

FOGLIE in OTTONE NON LUCIDATI / UNPOLISHED BRASS LEAVES



Art. 1460/3
H 265 mm
L 70 mm
Spess./Thickn. 4 mm



Art. 1460/4
H 265 mm
L 70 mm
Spess./Thickn. 4 mm



Art. 1460/6
H 180 mm
L 150 mm
Spess./Thickn. 4 mm



Art. 1461/1
H 185 mm
L 100 mm
Spess./Thickn. 4 mm



Art. 1461/2
H 185 mm
L 100 mm
Spess./Thickn. 4 mm



Art. 1460/5
H 355 mm
L 280 mm
Spess./Thickn. 4 mm



Art. 1460/7
H 285 mm
L 285 mm
Spess./Thickn. 4 mm



Art. 1462/3
H 255 mm
L 160 mm
Spess./Thickn. 4 mm



Art. 1462/4
H 165 mm
L 100 mm
Spess./Thickn. 4 mm



Art. 1462/5
H 195 mm
L 150 mm
Spess./Thickn. 4 mm



Art. 1462/6
H 125 mm
L 90 mm
Spess./Thickn. 4 mm



Art. 1460/6
H 150 mm
L 180 mm
Spess./Thickn. 4 mm



Art. 1463/16
H 110 mm
L 40 mm
Spess./Thickn. 4 mm



Art. 1463/17
H 110 mm
L 40 mm
Spess./Thickn. 4 mm



Art. 1463/13
H 97 mm
L 55 mm
Spess./Thickn. 3 mm



Art. 1463/11
H 295 mm
L 65 mm
Spess./Thickn. 3 mm



Art. 1463/14
H 60 mm
L 70 mm
Spess./Thickn. 4 mm



Art. 1463/15
H 60 mm
L 70 mm
Spess./Thickn. 4 mm



Art. 1463/12
H 90 mm
L 55 mm
Spess./Thickn. 3 mm



Art. 1751/6
H 200 mm
L 185 mm
Base 20 x 20 mm



Art. 1463/1
Ø 115 mm
Spess./Thickn. 4 mm



Art. 1463/4
Ø 115 mm
Spess./Thickn. 4 mm



Art. 1463/2
Ø 90 mm
Spess./Thickn. 4 mm



Art. 1463/3
Ø 90 mm
Spess./Thickn. 4 mm



Art. 1463/5
Ø 105 mm
Spess./Thickn. 4 mm

BRONZO / BRONZE



Art. 781/3
 Ø 12 mm
 H 125 mm
 L 90 mm

Art. 781/5
 Ø 12 mm
 H 125 mm
 L 90 mm

Art. 781/4
 Ø 12 mm
 H 150 mm
 L 110 mm

Art. 781/6
 Ø 12 mm
 H 150 mm
 L 110 mm



Art. 781/8
 Ø 12 mm
 H 170 mm
 L 130 mm

Art. 781/9
 Ø 12 mm
 H 170 mm
 L 130 mm



Art. 781/10
 Ø 12 mm
 H 180 mm
 L 100 mm

Art. 781/11
 Ø 12 mm
 H 180 mm
 L 100 mm



Art. 782/3
 Ø 12 mm
 H 140 mm
 L 110 mm

Art. 781/7
 Ø 12 mm
 H 160 mm
 L 110 mm



Art. 782/1
 Ø 12 mm
 H 400 mm
 L 300 mm

Art. 782/2
 Ø 12 mm
 H 550 mm
 L 350 mm



Art. 780/1
 Ø 12 mm
 H 110 mm
 L 85 mm

Art. 780/2
 Ø 12 mm
 H 110 mm
 L 85 mm

Art. 780/3
 Ø 12 mm
 H 130 mm
 L 100 mm

Art. 780/4
 Ø 12 mm
 H 130 mm
 L 100 mm

Art. 780/5
 Ø 12 mm
 H 170 mm
 L 120 mm

Art. 780/6
 Ø 12 mm
 H 170 mm
 L 120 mm



Art. 780/7
 Ø 12 mm
 H 170 mm
 L 120 mm

Art. 780/8
 Ø 12 mm
 H 170 mm
 L 120 mm

Art. 780/9
 Ø 12 mm
 H 185 mm
 L 135 mm

Art. 780/10
 Ø 12 mm
 H 185 mm
 L 135 mm

Art. 780/11
 Ø 12 mm
 H 235 mm
 L 180 mm

Art. 780/12
 Ø 12 mm
 H 235 mm
 L 180 mm



Art. 780/15
 Ø 12 mm
 H 240 mm
 L 180 mm

Art. 780/16
 Ø 12 mm
 H 240 mm
 L 180 mm

Art. 780/17
 Ø 12 mm
 H 295 mm
 L 210 mm

Art. 780/18
 Ø 12 mm
 H 295 mm
 L 210 mm

Art. 780/19
 Ø 12 mm
 H 350 mm
 L 270 mm

Art. 780/20
 Ø 12 mm
 H 350 mm
 L 270 mm

Art. 780/21
 Ø 12 mm
 H 430 mm
 L 330 mm

Art. 780/22
 Ø 12 mm
 H 430 mm
 L 330 mm



Art. 780/13
 Ø 12 mm
 H 230 mm
 L 170 mm

Art. 780/14
 Ø 12 mm
 H 230 mm
 L 170 mm



Art. 781/1
 Ø 12 mm
 H 180 mm
 L 100 mm

Art. 781/2
 Ø 12 mm
 H 180 mm
 L 100 mm



Art. 782/4
 Ø 12 mm
 H 420 mm
 L 330 mm



Art. 782/5
 Ø 12 mm
 H 280 mm
 L 210 mm

BRONZO / BRONZE



Art. 776/1
 Ø 12 mm
 H 470 mm
 L 470 mm



Art. 776/2
 Ø 12 mm
 H 720 mm
 L 720 mm

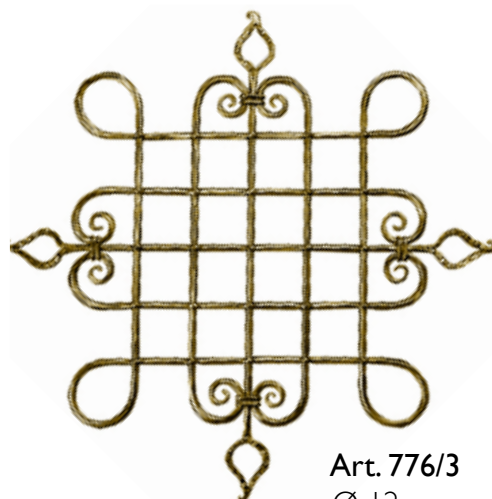

Art. 776/3
 Ø 12 mm
 H 830 mm
 L 830 mm



Art. 774/13
 H 75 mm
 L 510 mm



Art. 779/3
 Ø 12 mm
 H 590 mm
 L 240 mm



Art. 779/4
 Ø 12 mm
 H 590 mm
 L 240 mm



Art. 779/1
 Ø 12 mm
 H 810 mm
 L 360 mm



Art. 779/2
 Ø 12 mm
 H 810 mm
 L 360 mm



Art. 779/5
 Ø 12 mm
 H 740 mm
 L 320 mm



Art. 779/6
 Ø 12 mm
 H 740 mm
 L 320 mm



Art. 803/1
 φ 30 mm
 H 1000 mm
 L 350 mm



Art. 803/2
 ▽ 25 x 12 mm
 H 650 mm
 L 270 mm



Art. 803/3
 Ø 25 mm
 H 1100 mm
 base Ø 35 mm



Art. 786/1
 Ø 13 mm
 H 900 mm



Art. 786/3
 Ø 13 mm
 H 900 mm



Art. 786/2
 Ø 13 mm
 H 900 mm

BRONZO / BRONZE



ARTEFERRO



Art. 774/7
Ø 11 x 3 mm
L 1500 mm



Art. 774/11 Ø 46 x 8 mm L 2000 mm	Art. 774/10 Ø 25 x 7 mm L 1500 mm
Art. 774/12 Ø 54 x 10 mm L 2000 mm	Art. 774/9 Ø 19 x 5 mm L 1500 mm



Art. 774/8
Ø 15 x 5 mm
L 1500 mm

OTTONE e BRONZO - BRASS and BRONZE

BRONZO / BRONZE



Art. 783/1
H 150 mm
L 200 mm
Ø 12 mm
Spess./Thickn. 5 mm



Art. 783/2
H 150 mm
L 200 mm
Ø 12 mm
Spess./Thickn. 5 mm



Art. 783/3
H 220 mm
L 130 mm
Ø 12 mm
Spess./Thickn. 5 mm



Art. 783/4
H 220 mm
L 130 mm
Ø 12 mm
Spess./Thickn. 5 mm



Art. 783/5
H 210 mm
L 85 mm
Ø 12 mm
Spess./Thickn. 5 mm



Art. 783/6
H 210 mm
L 85 mm
Ø 12 mm
Spess./Thickn. 5 mm



Art. 783/7
H 240 mm
L 120 mm
Ø 12 mm
Spess./Thickn. 5 mm



Art. 783/8
H 240 mm
L 120 mm
Ø 12 mm
Spess./Thickn. 5 mm



Art. 783/9
H 230 mm
L 110 mm
Spess./Thickn. 5 mm



Art. 783/10
H 270 mm
L 85 mm
Spess./Thickn. 5 mm



Art. 783/11
H 180 mm
L 50 mm
Spess./Thickn. 5 mm



Art. 783/12
H 330 mm
L 100 mm
Spess./Thickn. 5 mm



Art. 784/1
H 120 mm
L 95 mm
Spess./Thickn. 5 mm



Art. 784/2
H 80 mm
L 80 mm
Spess./Thickn. 5 mm



Art. 785/5
H 200 mm
L 100 mm
Ø 10 mm



Art. 785/6
H 200 mm
L 100 mm
Ø 10 mm



Art. 784/4
H 150 mm
L 95 mm
Spess./Thickn. 5 mm



Art. 784/5
H 170 mm
L 95 mm
Spess./Thickn. 5 mm



Art. 785/10
H 80 mm
L 20 mm
Spess./Thickn. 3 mm



Art. 785/9
H 100 mm
L 20 mm
Spess./Thickn. 3 mm



Art. 785/7
H 280 mm
L 70 mm
Ø 10 mm



Art. 785/8
H 280 mm
L 70 mm
Ø 10 mm



Art. 784/3
H 160 mm
L 80 mm
Spess./Thickn. 5 mm



Art. 785/11
H 190 mm
L 95 mm
Spess./Thickn. 6 mm



Art. 785/12
H 210 mm
L 120 mm
Spess./Thickn. 6 mm



Art. 785/13
H 210 mm
L 120 mm
Spess./Thickn. 6 mm



ALLUMINIO - ALUMINIUM

COMPENDIUM 2011

Art. 769/I



Art. 770/6
 ∅ 12 x 6 mm
 H 150 mm
 L 105 mm



Art. 770/15
 ∅ 12 x 6 mm
 H 150 mm
 L 105 mm



Art. 770/7
 ∅ 12 x 6 mm
 H 125 mm
 L 75 mm



Art. 770/8
 ∅ 12 x 6 mm
 H 120 mm
 L 75 mm



Art. 1867/7
 ∅ 12 x 6 mm
 H 215 mm
 L 140 mm

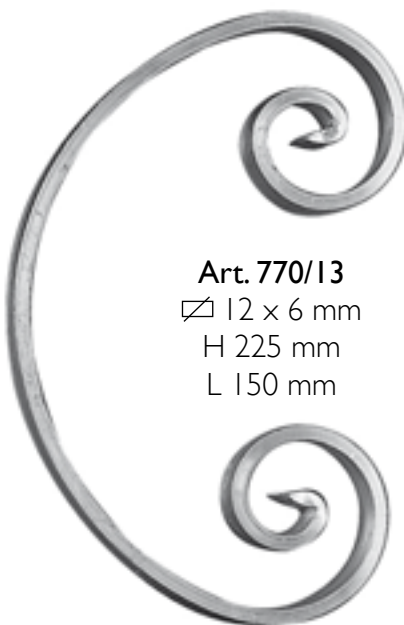

Art. 770/13
 ∅ 12 x 6 mm
 H 225 mm
 L 150 mm



Art. 770/9
 ∅ 12 x 6 mm
 H 180 mm
 L 90 mm



Art. 770/10
 ∅ 12 x 6 mm
 H 115 mm
 L 60 mm



Art. 1437/19
 ∅ 20 x 6 mm
 H 185 mm
 L 90 mm



ARTEFERRO

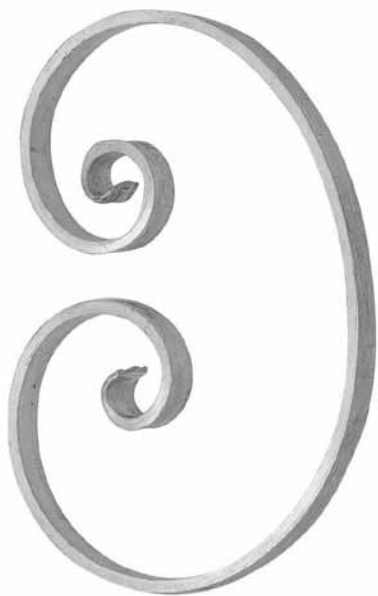

Art. 1437/16
 □ 20 x 6 mm
 H 255 mm
 L 185 mm

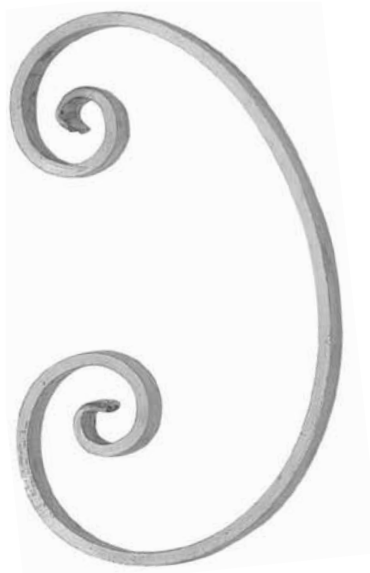

Art. 1437/17
 □ 20 x 6 mm
 H 250 mm
 L 150 mm



Art. 1437/18
 □ 20 x 6 mm
 H 205 mm
 L 145 mm



Art. 1867/5
 □ 14 x 14 mm
 H 230 mm
 L 160 mm



Art. 1438/3
 □ 14 x 14 mm
 H 225 mm
 L 160 mm



Art. 770/14
 □ 12 x 6 mm
 H 180 mm
 L 120 mm

Art. 1867/6
 □ 14 x 14 mm
 H 230 mm
 L 160 mm



Art. 768/1
 □ 12 x 6 mm
 H 105 mm
 L 90 mm



Art. 768/2
 □ 12 x 6 mm
 H 105 mm
 L 90 mm



Art. 1867/4
 □ 14 x 14 mm
 H 255 mm
 L 170 mm



Art. 770/5
 Ø 12 x 6 mm
 H 350 mm
 L 120 mm



Art. 770/4
 Ø 12 x 6 mm
 H 290 mm
 L 120 mm



Art. 770/3
 Ø 12 x 6 mm
 H 220 mm
 L 120 mm



Art. 770/2
 Ø 12 x 6 mm
 H 510 mm
 L 112 mm



Art. 1436/4
 Ø 20 x 6 mm
 H 410 mm
 L 295 mm



Art. 1436/5
 Ø 14 x 14 mm
 H 420 mm
 L 280 mm



Art. 770/12
 Ø 12 x 6 mm
 H 370 mm
 L 145 mm



Art. 770/1
 Ø 12 x 6 mm
 H 250 mm
 L 160 mm



Art. 770/11
 Ø 12 x 6 mm
 H 460 mm
 L 84 mm



ARTEFERRO

Ø = diameter



Sezione/Section	Ø 100 mm	Ø 115 mm	Ø 130 mm
	Cod.art./Art.no.	Cod.art./Art.no.	Cod.art./Art.no.
12 x 6 mm	772/13	772/14	772/15
20 x 6 mm	1443/7	1443/8	1443/9
14 x 14 mm	1443/10	1443/11	1443/12



Sezione/Section	Ø 100 mm	Ø 115 mm	Ø 130 mm
	Cod.art./Art.no.	Cod.art./Art.no.	Cod.art./Art.no.
14 x 14 mm	772/10	772/11	772/12

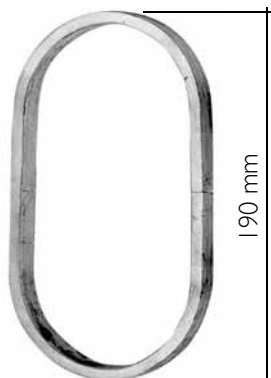

Sezione/Section	L 100 mm	L 115 mm	L 130 mm
	Cod.art./Art.no.	Cod.art./Art.no.	Cod.art./Art.no.
12 x 6 mm	1443/1	1443/2	1443/3
20 x 6 mm	1443/4	1443/5	1443/6



Art. 1867/1
12 x 6 mm
Ø 330 mm



Art. 1867/2
12 x 6 mm
Ø 250 mm



Art. 1867/3
12 x 6 mm
Ø 260 mm

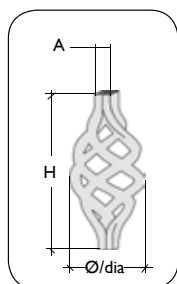

Cod.art./Art.no.	Ø	H	A
772/8	60 mm	130 mm	14 x 14 mm
1443/13	75 mm	150 mm	16 x 16 mm
772/9	95 mm	180 mm	25 x 25 mm

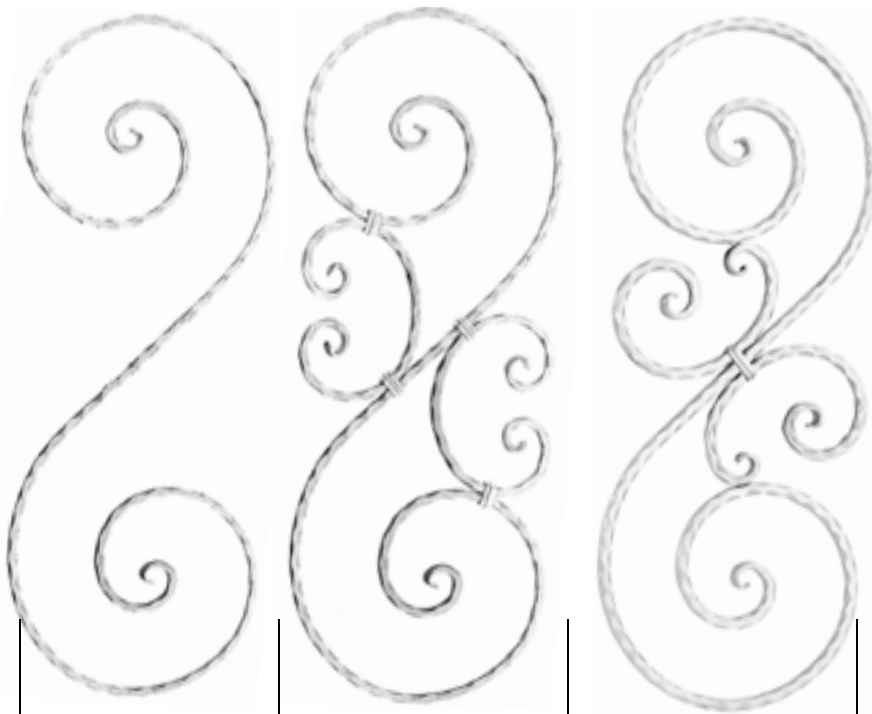

Sezione/Section
 Φ 14 x 14 mm
 H 900 mm L 370 mm

Cod.art./Art.no.
1438/2

Cod.art./Art.no.
1438/1

Cod.art./Art.no.
1869/3

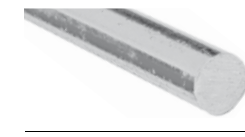

Φ 14 mm
 H 900 mm L 350 mm

Cod.art./Art.no.
1869/4

Cod.art./Art.no.
1869/1

Cod.art./Art.no.
1869/2

ALLUMINIO - ALUMINIUM



Art. 767/2
 Φ 20 x 6 mm
 H 720 mm
 L 235 mm



Art. 767/3
 Φ 20 x 6 mm
 H 720 mm
 L 235 mm



Art. 767/1
 Φ 12 x 6 mm
 H 570 mm
 L 310 mm



Art. 1869/5
 Φ 12 x 12 mm
 H 1000 mm
 L 185 mm





Art. 768/6
 \varnothing 14 x 14 mm
 H 1000 mm
 L 30 mm



Art. 769/4
 \varnothing 14 x 14 mm
 H 1000 mm



Art. 769/12
 \varnothing 14 x 14 mm
 H 1000 mm



Art. 1444/7
 \varnothing 20 x 20 mm
 H 1000 mm

Art. 1444/17
 \varnothing 16 x 16 mm
 H 1000 mm



Art. 1444/9
 \varnothing 14 x 14 mm
 H 1000 mm

Art. 1444/18
 \varnothing 16 x 16 mm
 H 1000 mm



ARTEFERRO



\varnothing 40 x 8 mm
 H 1000 mm

Art. 769/3
 spigolato
 hammered on edges
Art. 1870/3
 liscio/plain



Art. 1444/8
 \varnothing 40 x 8 mm
 H 1000 mm
 L 200 mm



Art. 1870/1
 \varnothing 40 x 8 mm
 H 1000 mm
 L 200 mm



Art. 1870/2
 \varnothing 40 x 8 mm
 H 1000 mm
 L 200 mm



Art. 768/3
 Ø 14 x 14 mm
 H 1000 mm
 L 140 mm



Art. 768/7
 Ø 14 x 14 mm
 H 1000 mm
 L 110 mm



Art. 768/8
 Ø 14 x 14 mm
 H 1000 mm
 L 225 mm



Art. 768/9
 Ø 14 x 14 mm
 H 1000 mm
 L 210 mm



Art. 769/1
 Ø 14 x 14 mm
 H 1000 mm
 L 235 mm



Art. 1444/6
 Ø 20 x 20 mm
 H 1000 mm
 L 200 mm

Art. 1444/16
 Ø 16 x 16 mm
 H 1000 mm
 L 200 mm



Art. 769/6
 Ø 14 x 14 mm
 H 1000 mm
 L 300 mm



Art. 769/5
 Ø 14 x 14 mm
 H 1000 mm
 L 180 mm



Art. 768/4
 Ø 14 x 14 mm
 H 1000 mm



Art. 768/5
 Ø 14 x 14 mm
 H 1000 mm



Art. 768/11
 Ø 14 x 14 mm
 H 1000 mm
 L 100 mm





Art. 1444/1
 \varnothing 20 x 20 mm
 H 1120 mm
Art. 1444/11
 \varnothing 16 x 16 mm
 H 1120 mm

Art. 1444/2
 \varnothing 20 x 20 mm
 H 1120 mm
Art. 1444/12
 \varnothing 16 x 16 mm
 H 1120 mm

Art. 1444/3
 \varnothing 20 x 20 mm
 H 1120 mm
Art. 1444/13
 \varnothing 16 x 16 mm
 H 1120 mm



Art. 769/2
 \varnothing 14 x 14 mm
 H 1000 mm

Art. 769/8
 \varnothing 14 x 14 mm
 H 1000 mm

Art. 769/7
 \varnothing 14 x 14 mm
 H 1000 mm



ARTEFERRO



Art. 1869/7
 \varnothing 14 x 14 mm
 H 1000 mm

Art. 1869/6
 \varnothing 14 x 14 mm
 H 1000 mm

Art. 1869/9
 \varnothing 14 x 14 mm
 H 1000 mm

Art. 1869/8
 \varnothing 14 x 14 mm
 H 1000 mm

ALLUMINIO - ALUMINIUM



Art. 1440/2
 \varnothing 16 x 16 mm
 H 1000 mm
 L 65 mm



Art. 1440/1
 \varnothing 16 x 16 mm
 H 1000 mm
 L 65 mm



Art. 1869/10
 \varnothing 14 x 14 mm
 H 1000 mm



Art. 1444/5
 \varnothing 20 x 20 mm
 H 1120 mm



Art. 1444/4
 \varnothing 20 x 20 mm
 H 1120 mm



Art. 1440/10
 \varnothing 14 x 14 mm
 H 1200 mm



Art. 769/10
 \varnothing 14 x 14 mm
 H 1000 mm
 L 55 mm



Art. 769/9
 \varnothing 14 x 14 mm
 H 1000 mm
 L 55 mm



Art. 769/13
 \varnothing 14 x 14 mm
 H 1000 mm



Art. 1444/15
 \varnothing 16 x 16 mm
 H 1120 mm

Art. 1444/14
 \varnothing 16 x 16 mm
 H 1120 mm

Art. 1440/19
 \varnothing 14 x 14 mm
 H 1200 mm



ARTEFERRO

PALETTI IN ALLUMINIO FORGIATO ALUMINIUM FORGED PICKETS



Art. 1445/5
 \square 14 x 14 mm
 H 1000 mm



Art. 1445/4
 \square 12 x 12 mm
 H 1000 mm



Art. 1445/3
 \square 12 x 12 mm
 H 1000 mm



Art. 1445/2
 \square 14 x 14 mm
 H 1000 mm



Art. 1445/1
 \square 14 x 14 mm
 H 1000 mm



Art. 1446/6
 \varnothing 12 mm
 H 1000 mm



Art. 1446/5
 \varnothing 12 mm
 H 1000 mm



Art. 1446/4
 \square 12 x 12 mm
 H 1000 mm



Art. 1446/3
 \square 12 x 12 mm
 H 1000 mm



Art. 1446/2
 \square 14 x 14 mm
 H 1000 mm



Art. 1446/1
 H 1000 mm

CAPOSALDI FORGIATI NEWEL POSTS FORGED



Art. 1448/2
 \square 30 x 30 mm
 H 1200 mm



Art. 1448/1
 \varnothing 30 mm
 H 1200 mm



Art. 1448/3
 \square 30 x 30 mm
 H 1200 mm



Art. 768/10
 \square 25 x 25 mm
 H 1200 mm



Art. 769/11
 \square 25 x 25 mm
 H 1200 mm



Art. 772/16
 \square 14 x 14 mm
 L 3000 mm



Art. 772/17
 \square 14 x 14 mm
 L 1600 mm



ARTEFERRO



Art. 1447/29



Art. 1447/11



Art. 1447/9
Ø 53 x 9 mm
L 3000 mm



Art. 1872/8 - L 2600 mm



Art. 1872/18 - L 2800 mm



Art. 1447/30



Art. 1447/12



Art. 1447/10
Ø 47 x 14 mm
L 3000 mm



Art. 1872/9 - L 2600 mm



Art. 1872/19 - L 2800 mm



ALLUMINIO - ALUMINIUM

Art. 1447/1
40 x 8 mm
L 3000 mm



Art. 1447/14



Art. 1447/22



Art. 1872/1 - L 2600 mm

Art. 1872/11 - L 2800 mm

Art. 1447/6
40 x 8 mm
L 3000 mm



Art. 1447/19



Art. 1447/27

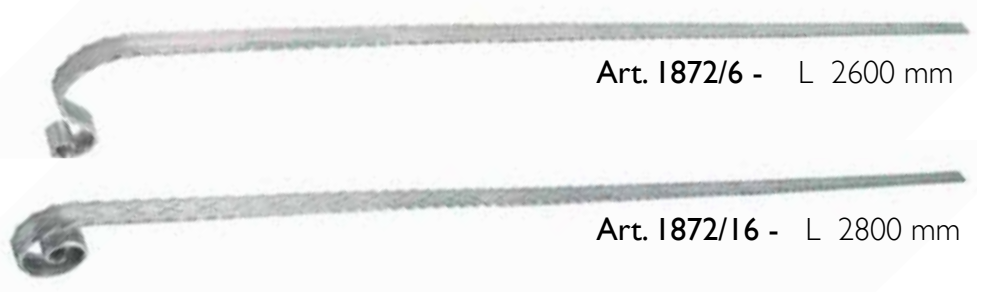

Art. 1872/6 - L 2600 mm

Art. 1872/16 - L 2800 mm



Art. 772/1



Art. 1447/21



Art. 772/2
40 x 8 mm
L 3000 mm



Art. 1872/10 - L 2600 mm



Art. 1872/20 - L 2800 mm



Art. 1447/23



Art. 1447/15



Art. 1447/2
40 x 8 mm
L 3000 mm



Art. 1872/2 - L 2600 mm



Art. 1872/12 - L 2800 mm



Art. 1447/24



Art. 1447/16



Art. 1447/3
40 x 8 mm
L 3000 mm



Art. 1872/3 - L 2600 mm



Art. 1872/13 - L 2800 mm

Art. 1447/5
 □ 40 × 8 mm
 L 3000 mm



Art. 1447/18



Art. 1447/26



Art. 1872/5 - L 2600 mm



Art. 1872/15 - L 2800 mm

Art. 1447/4
 □ 40 × 8 mm
 L 3000 mm

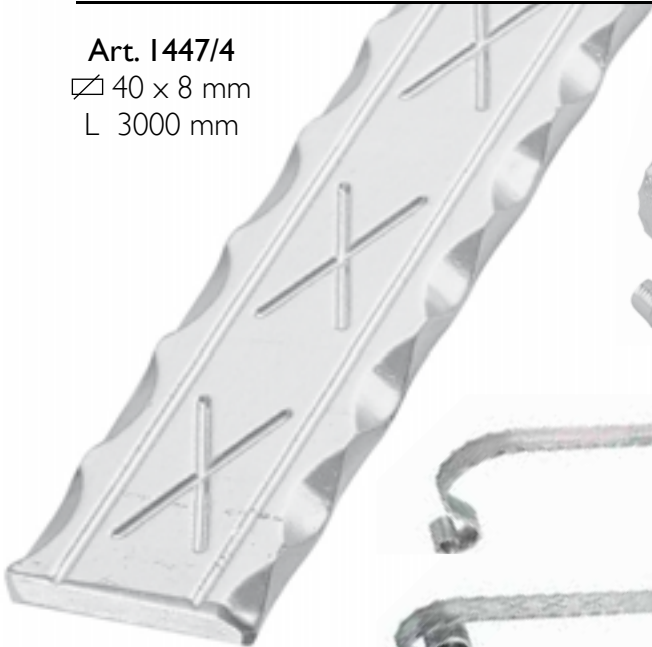

Art. 1447/17



Art. 1447/25



Art. 1872/4 - L 2600 mm



Art. 1872/14 - L 2800 mm

Art. 1447/7
 □ 40 × 8 mm
 L 3000 mm



Art. 1447/20



Art. 1447/28



Art. 1872/7 - L 2600 mm



Art. 1872/17 - L 2800 mm

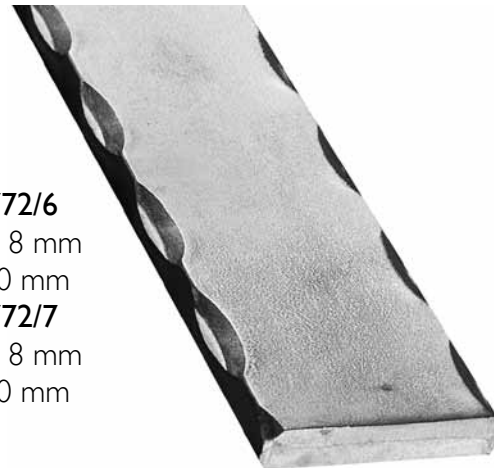
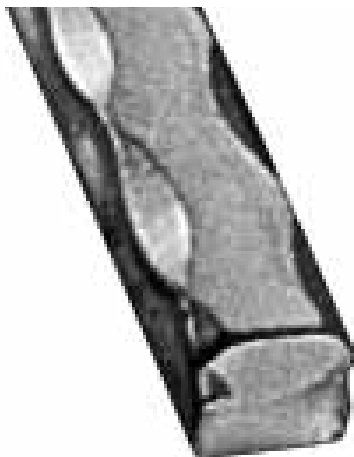

Art. 772/4
 \square 14 x 14 mm
 L 3000 mm
Art. 772/5
 \square 25 x 25 mm
 L 3000 mm

Art. 772/6
 \square 40 x 8 mm
 L 3000 mm
Art. 772/7
 \square 30 x 8 mm
 L 3000 mm

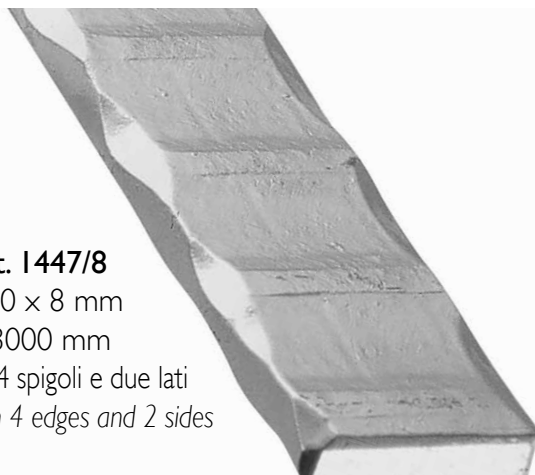
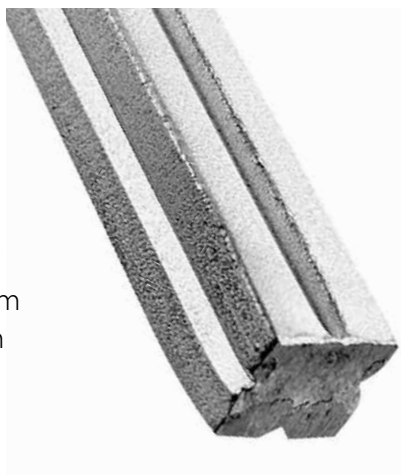

Art. 1871/7
 \square 14 x 14 mm
 L 3000 mm

Art. 1447/8
 \square 30 x 8 mm
 L 3000 mm
 Battuto su 4 spigoli e due lati
Hammered on 4 edges and 2 sides

spessore/thickness 2 mm
 L 6000 mm

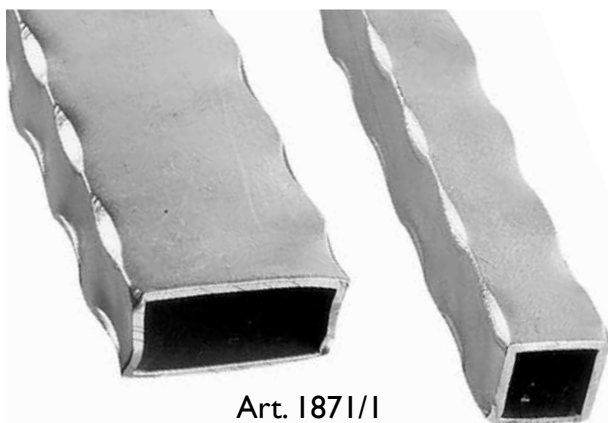

Art. 1871/1
 \square 20 x 20 mm
Art. 1871/2
 \square 25 x 25 mm
Art. 1871/3
 \square 30 x 30 mm
Art. 1871/4
 \square 40 x 40 mm
Art. 1871/5
 \square 40 x 20 mm
Art. 1871/6
 \square 60 x 30 mm

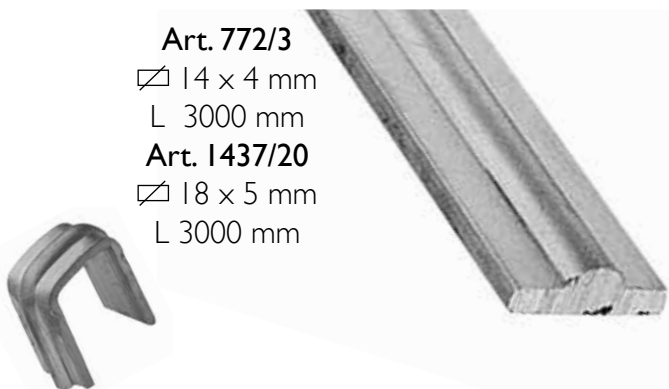

Art. 772/3
 \square 14 x 4 mm
 L 3000 mm
Art. 1437/20
 \square 18 x 5 mm
 L 3000 mm

- Art. 1437/1** - perfor 2 barre / bars \square 20 x 6 mm
- Art. 1437/2** - perfor \square 14 mm + 4 barre / bars \square 12 x 6 mm
- Art. 1437/3** - perfor \square 14 mm + 2 barre / bars \square 12 x 6 mm
- Art. 1437/4** - perfor 1 barra / bar \square 14 mm
- Art. 1437/5** - perfor 1 barra / bar \square 25 mm
- Art. 1437/6** - perfor 2 barre/ bars \square 8 mm
- Art. 1437/7** - perfor 3 barre / bars \square 8 mm
- Art. 1437/8** - perfor 4 barre / bars \square 8 mm
- Art. 1437/9** - perfor 2 barre / bars \square 10 mm
- Art. 1437/10** - perfor 3 barre / bars \square 10 mm
- Art. 1437/11** - perfor 2 barre / bars \square 10 x 5 mm
- Art. 1437/12** - perfor 2 barre / bars \square 12 x 6 mm
- Art. 1437/13** - perfor 3 barre / bars \square 12 x 6 mm
- Art. 1437/14** - perfor 4 barre / bars \square 12 x 6 mm + 2 \square 12 mm
- Art. 1437/15** - perfor 6 barre / bars \square 12 x 6 mm + 2 \square 12 mm



Art. 771/8
 Ø 19 mm
 H 195 mm
Art. 771/9
 Ø 16 mm
 H 160 mm
Art. 771/10
 Ø 13 mm
 H 130 mm



Art. 771/11
 Ø 12 mm
 H 125 mm
Art. 771/12
 Ø 15 mm
 H 160 mm



Art. 771/13
 Ø 14 mm
 H 140 mm
Art. 771/14
 Ø 16 mm
 H 170 mm



Art. 1448/11
 Ø 33 mm
 H 140 mm



Art. 771/7
 14 x 14 mm
 H 140 mm



Art. 771/6
 Ø 20 mm



Art. 771/3
 Ø 65 mm



ARTEFERRO



Art. 1448/4
 Ø 115 mm
 foro/hole
 Ø 10 mm
 spess./thick. 4 mm

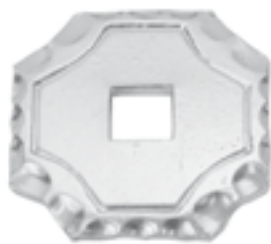

Art. 1448/6
 70 x 70 mm
 foro/hole
 12 x 12 mm
 spess./thick. 4 mm

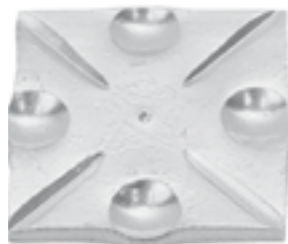

Art. 1448/8
 80 x 80 mm
 spess./thick. 8 mm



Art. 1448/10
 Ø 70 mm
 H 120 mm
 forgiato
 forged



Art. 1448/5
 Ø 90 mm
 foro/hole
 Ø 12 mm
 spess./thick. 4 mm

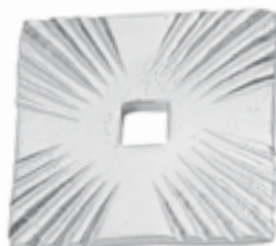

Art. 1448/7
 75 x 75 mm
 foro/hole
 12 x 12 mm
 spess./thick. 4 mm



Art. 1448/9
 100 x 100 mm
 spess./thick. 8 mm



Art. 1869/11
 Ø 40 mm
 H 23 mm
 foro/hole
 15 x 15 mm



Art. 1454/5
 Ø 105 mm
 spess./thick. 4 mm



Art. 771/1
 H 110 mm
 L 40 mm



Art. 771/2
 H 110 mm
 L 40 mm



Art. 771/4
 H 70 mm
 L 60 mm



Art. 771/5
 H 70 mm
 L 60 mm



Art. 1454/6
 Ø 125 mm
 spess./thick. 4 mm



Art. 1454/7
 H 90 mm
 L 65 mm
 Ø 12 mm
 spess./thick. 4 mm



Art. 1454/8
 H 90 mm
 L 65 mm
 Ø 12 mm
 spess./thick. 4 mm



Art. 1454/9
 H 120 mm
 L 85 mm
 Ø 12 mm
 spess./thick. 4 mm



Art. 1454/10
 H 120 mm
 L 85 mm
 Ø 12 mm
 spess./thick. 4 mm



ARTEFERRO



Art. 1452/5
 H 120 mm
 L 70 mm
 Ø 12 mm
 spess./thick. 4 mm



Art. 1452/6
 H 120 mm
 L 70 mm
 Ø 12 mm
 spess./thick. 4 mm



Art. 1452/3
 H 160 mm
 L 80 mm
 Ø 12 mm
 spess./thick. 4 mm



Art. 1452/4
 H 160 mm
 L 80 mm
 Ø 12 mm
 spess./thick. 4 mm



Art. 1451/1
H 210 mm
L 120 mm
spess./thick. 4 mm



Art. 1451/2
H 210 mm
L 120 mm
spess./thick 4 mm



Art. 1451/3
H 220 mm
L 120 mm
spess./thick 4 mm



Art. 1451/4
H 210 mm
L 120 mm
spess./thick 4 mm



Art. 1451/5
H 240 mm
L 120 mm
spess./thick 4 mm



Art. 1451/6
H 240 mm
L 120 mm
spess./thick 4 mm



Art. 1451/7
H 100 mm
L 160 mm
spess./thick 4 mm



Art. 1451/8
H 100 mm
L 160 mm
spess./thick 4 mm



Art. 1451/9
H 150 mm
L 220 mm
spess./thick 4 mm



Art. 1451/10
H 150 mm
L 220 mm
spess./thick 4 mm



Art. 1452/1
H 100 mm
L 160 mm
spess./thick 4 mm



Art. 1452/2
H 100 mm
L 160 mm
spess./thick 4 mm



Art. 1454/11
H 180 mm
L 130 mm
spess./thick 4 mm



Art. 1454/12
H 180 mm
L 130 mm
spess./thick 4 mm

Art. 1454/13
H 150 mm
L 180 mm
spess./thick 4 mm

Art. 1454/14
H 150 mm
L 180 mm
spess./thick 4 mm

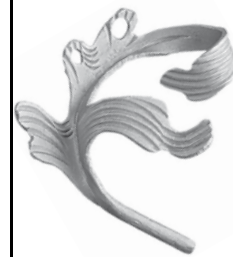

Art. 1454/15
H 160 mm
L 150 mm
spess./thick 4 mm



Art. 1454/16
H 160 mm
L 150 mm
spess./thick 4 mm



ARTEFERRO



Art. 1450/1
H 270 mm
L 85 mm
spess./thick 4 mm



Art. 1450/8
H 160 mm
L 80 mm
spess./thick 4 mm



Art. 1450/9
H 170 mm
L 95 mm
spess./thick 4 mm



Art. 1450/4
H 230 mm
L 110 mm
spess./thick 4 mm



Art. 1450/3
H 180 mm
L 50 mm
spess./thick 4 mm



Art. 1450/2
H 330 mm
L 100 mm
spess./thick 4 mm



Art. 1450/7
H 80 mm
L 80 mm
spess./thick 4 mm



Art. 1450/5
H 95 mm
L 60 mm
spess./thick 4 mm



Art. 1450/6
H 120 mm
L 95 mm
spess./thick 4 mm



Art. 1450/10
H 150 mm
L 95 mm
spess./thick 4 mm



Art. 1453/7
H 90 mm
L 55 mm
spess./thick 4 mm



Art. 1453/8
H 97 mm
L 55 mm
spess./thick 4 mm



Art. 1452/7
H 160 mm
L 80 mm
Ø 12 mm
spess./thick 4 mm



Art. 1452/8
H 160 mm
L 80 mm
Ø 12 mm
spess./thick 4 mm



Art. 1452/9
H 100 mm
L 80 mm
Ø 12 mm
spess./thick 4 mm



Art. 1452/10
H 100 mm
L 80 mm
Ø 12 mm
spess./thick 4 mm



Art. 1454/1
H 140 mm
L 70 mm
Ø 12 mm
spess./thick 4 mm



Art. 1454/2
H 200 mm
L 70 mm
Ø 12 mm
spess./thick 4 mm



Art. 1453/1
H 390 mm
L 155 mm
spess./thick 4 mm



Art. 1453/2
H 360 mm
L 110 mm
spess./thick 4 mm



Art. 1453/3
H 360 mm
L 110 mm
spess./thick 4 mm



Art. 1453/4
H 240 mm
L 77 mm
spess./thick 4 mm



Art. 1453/5
H 190 mm
L 45 mm
spess./thick 4 mm



Art. 1453/6
H 190 mm
L 45 mm
spess./thick 4 mm



Art. 1436/1
 □ 20 x 6 mm
 H 850 mm
 L 330 mm

Art. 1435/3
 □ 20 x 6 mm
 H 840 mm
 L 330 mm



Art. 1436/2
 □ 20 x 6 mm
 H 700 mm
 L 310 mm

Art. 1435/4
 □ 20 x 6 mm
 H 700 mm
 L 310 mm



Art. 1436/3
 □ 20 x 6 mm
 H 620 mm
 L 260 mm

Art. 1435/5
 □ 20 x 6 mm
 H 620 mm
 L 260 mm



Art. 1435/1
 □ 20 x 6 mm
 H 420 mm - L 1310 mm

Art. 1435/2
 □ 20 x 6 mm
 H 420 mm - L 1100 mm



FORGINOX

COMPENDIUM 2011

Art. 1416/3/X
Art. 1419/1/X
Art. 1419/4/X
Art. 1423/12
Art. 1424/18



Art. 1425/14
 □ 12 x 12 mm
 H 130 mm
 L 80 mm



Art. 1425/15
 Ø 12 mm
 H 130 mm
 L 80 mm



Art. 1425/26
 ▧ 12 x 6 mm
 H 140 mm
 L 60 mm



Art. 1425/25
 ▧ 12 x 6 mm
 H 105 mm
 L 70 mm



Art. 1425/18
 □ 12 x 12 mm
 H 120 mm
 L 110 mm



Art. 1425/24
 ▧ 12 x 6 mm
 H 140 mm
 L 95 mm



Art. 1425/23
 ▧ 12 x 6 mm
 H 210 mm
 L 130 mm



ARTEFERRO



Art. 1425/20
 \square 12 x 6 mm
 H 260 mm
 L 65 mm

Art. 1425/19
 \square 12 x 6 mm
 H 290 mm
 L 80 mm

Art. 1425/22
 \square 12 x 6 mm
 H 190 mm
 L 70 mm

Art. 1425/16
 \square 12 x 12 mm
 H 300 mm
 L 110 mm

Art. 1425/17
 \square 12 x 12 mm
 H 220 mm
 L 110 mm

Art. 1425/21
 \square 12 x 6 mm
 H 270 mm
 L 110 mm



Sezione Section	Ø 100 mm	Ø 115 mm	Ø 130 mm
	Cod.art./Art.no.	Cod.art./Art.no.	Cod.art./Art.no.
\square 12 x 6 mm	1425/27	1425/28	1425/29
\square 20 x 6 mm	1425/30	1425/31	1425/32
\square 12 x 12 mm	1425/33	1425/34	1425/35

ARTEFERRO



Art. 1422/15
 □ 12 x 12 mm
 H 1000 mm
 L 140 mm



Art. 1422/14
 □ 12 x 12 mm
 H 1000 mm
 L 140 mm



Art. 1422/A/2
 Ø 10 mm
 H 1000 mm
 L 100 mm



Art. 1422/A/1
 Ø 10 mm
 H 1000 mm
 L 100 mm



Art. 1422/A/4
 □ 12 x 12 mm
 H 1000 mm
 L 160 mm



Art. 1422/A/3
 □ 12 x 12 mm
 H 1000 mm
 L 160 mm



Art. 1422/A/5
 Ø 12 mm
 H 1000 mm
 L 75 mm



Art. 1422/A/6
 Ø 12 mm
 H 1000 mm
 L 100 mm



Art. 1422/A/8
 Ø 12 mm
 H 1000 mm
 L 80 mm



Art. 1422/A/9
 Ø 12 mm
 H 1000 mm
 L 80 mm



Art. 1422/A/10
 Ø 12 mm
 H 1000 mm
 L 150 mm



Art. 1422/A/11
 Ø 12 mm
 H 1000 mm
 L 150 mm



Art. 1422/B/2
 Ø 12 mm
 H 1000 mm
 L 130 mm



Art. 1422/B/3
 Ø 12 mm
 H 1000 mm
 L 130 mm



Art. 1422/B/4
 Ø 12 mm
 H 1000 mm
 L 130 mm



Art. 1422/B/5
 Ø 12 mm
 H 1000 mm
 L 100 mm



Art. 1426/2
 Ø 12 mm
 H 1000 mm
 L 125 mm



Art. 1426/3
 Ø 12 mm
 H 1000 mm
 L 125 mm



Art. 1422/C/11
 Ø 10 mm
 H 1000 mm
 L 230 mm



Art. 1422/C/12
 Ø 10 mm
 H 1000 mm
 L 205 mm



Art. 1422/C/13
 Ø 10 mm
 H 1000 mm
 L 240 mm



Art. 1422/C/14
 Ø 10 mm
 H 1000 mm
 L 160 mm



Art. 1426/10
 Ø 12 mm
 H 1000 mm



Art. 1426/11
 Ø 12 mm
 H 1000 mm



Art. 1422/1
 Ø 12 mm
 H 1000 mm



Art. 1422/2
 Ø 12 mm
 H 1000 mm



Art. 1422/3
 Ø 12 mm
 H 1000 mm



Art. 1422/4
 Ø 12 mm
 H 1000 mm



Art. 1426/12
 Ø 12 mm
 H 1000 mm



Art. 1422/9
 12 x 12 mm
 H 1000 mm



Art. 1422/10
 12 x 12 mm
 H 1000 mm



Art. 1422/11
 12 x 12 mm
 H 1000 mm



Art. 1422/5
 ⌀ 12 x 12 mm
 H 1000 mm



Art. 1422/6
 ⌀ 12 x 12 mm
 H 1000 mm



Art. 1422/7
 ⌀ 12 x 12 mm
 H 1000 mm



Art. 1422/8
 ⌀ 12 x 12 mm
 H 1000 mm



Art. 1422/12
 ⌀ 12 x 12 mm
 H 1000 mm



Art. 1422/13
 ⌀ 12 x 12 mm
 H 1000 mm



Art. 1422/A/7
 Ø 12 mm
 H 1000 mm
 L 60 mm



Art. 1422/B/1
 Ø 12 mm
 H 1000 mm



Art. 1422/C/1
 ⌀ 12 x 12 mm
 H 1000 mm



Art. 1422/C/2
 ⌀ 12 x 12 mm
 H 1000 mm



Art. 1422/B/16
 Ø 12 mm
 H 1000 mm



Art. 1422/B/17
 Ø 12 mm
 H 1000 mm

Art. 1422/B/18
 ⌀ 12 x 12 mm
 H 1000 mm

Art. 1422/B/19
 ⌀ 12 x 12 mm
 H 1000 mm



Art. 1422/C/3
 ⌀ 12 x 12 mm
 H 1000 mm



Art. 1422/C/4
 8 x 16 mm
 H 1000 mm
 L 125 mm



Art. 1422/C/5
 8 x 16 mm
 H 1000 mm
 L 150 mm



Art. 1422/C/6
 8 x 16 mm
 H 1000 mm
 L 70 mm



ARTEFERRO



Art. 1422/C/7
8 x 16 mm
H 1000 mm
L 120 mm



Art. 1422/C/8
8 x 16 mm
H 1000 mm
L 90 mm



Art. 1422/C/9
8 x 16 mm
H 1000 mm



Art. 1422/C/10
8 x 16 mm
H 1000 mm



Art. 1426/10
Ø 12 mm
H 1000 mm



Art. 1426/11
Ø 12 mm
H 1000 mm



Art. 1426/12
Ø 12 mm
H 1000 mm



Art. 1426/A/2
Ø 30 mm
H 1000 mm



Art. 1426/A/3
Ø 30 mm
H 1000 mm



Art. 1426/A/4
Ø 30 mm
H 1000 mm



Art. 1426/A/5
Ø 30 mm
H 1000 mm



Art. 1426/A/6
Ø 30 mm
H 1000 mm



ARTEFERRO



Art. 1426/A/7
Ø 12 mm
H 1000 mm



Art. 1426/A/8
Ø 30 mm
H 1000 mm



Art. 1426/A/9
Ø 30 mm
H 1000 mm



Art. 1426/A/10
Ø 30 mm
H 1000 mm



Art. 1426/A/11
Ø 30 mm
H 1000 mm

PALETTI FORGIATI in ACCIAIO INOX
STAINLESS STEEL HAND FORGED PICKETS

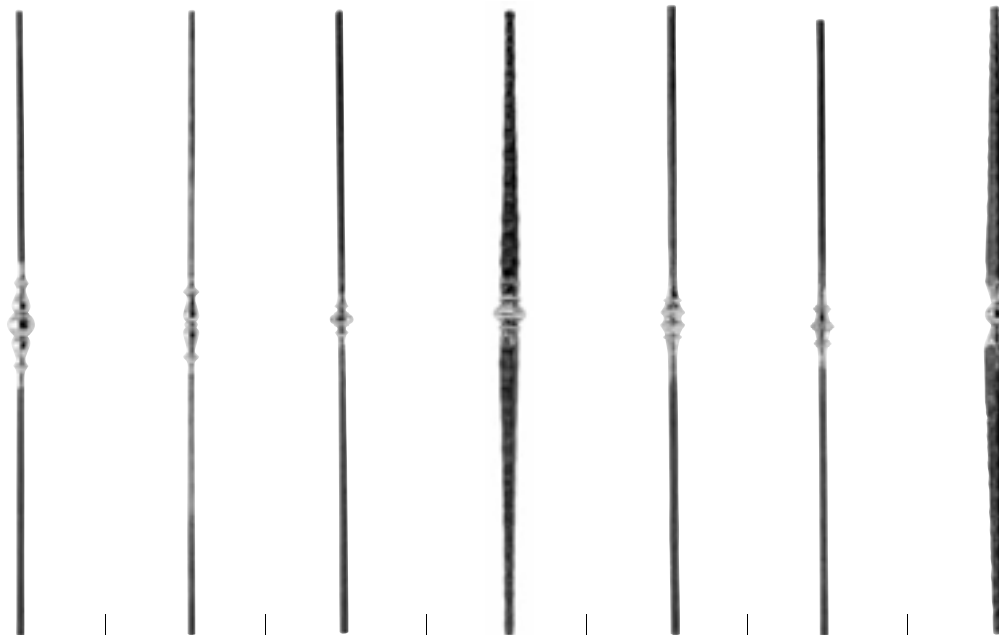

	Cod.art. Art.no.	Cod.art. Art.no.	Cod.art. Art.no.	Cod.art. Art.no.	Cod.art. Art.no.	Cod.art. Art.no.	Cod.art. Art.no.
Paletto Grezzo con borchia lucida <i>Unpolished picket with polished boss</i>	1417/1	1417/2	1417/3	1418/1	1418/2	1418/3	1419/3
Paletto Lucido con borchia lucida <i>Polished picket with polished boss</i>	1417/1/X	1417/2/X	1417/3/X	1418/1/X	1418/2/X	1418/3/X	1419/3/X
Paletto Grezzo con borchia lucida <i>Sandlasted picket with polished boss</i>	1417/1/Y	1417/2/Y	1417/3/Y	1418/1/Y	1418/2/Y	1418/3/Y	1419/3/Y



Paletto Grezzo
con borchia lucida

*Unpolished picket
with polished boss*



Paletto Lucido
con borchia lucida

*Polished picket
with polished boss*



Paletto Grezzo
con borchia lucida

*Sandlasted picket
with polished boss*

PALETTI FORGIATI IN ACCIAIO INOX STAINLESS STEEL HAND FORGED PICKETS

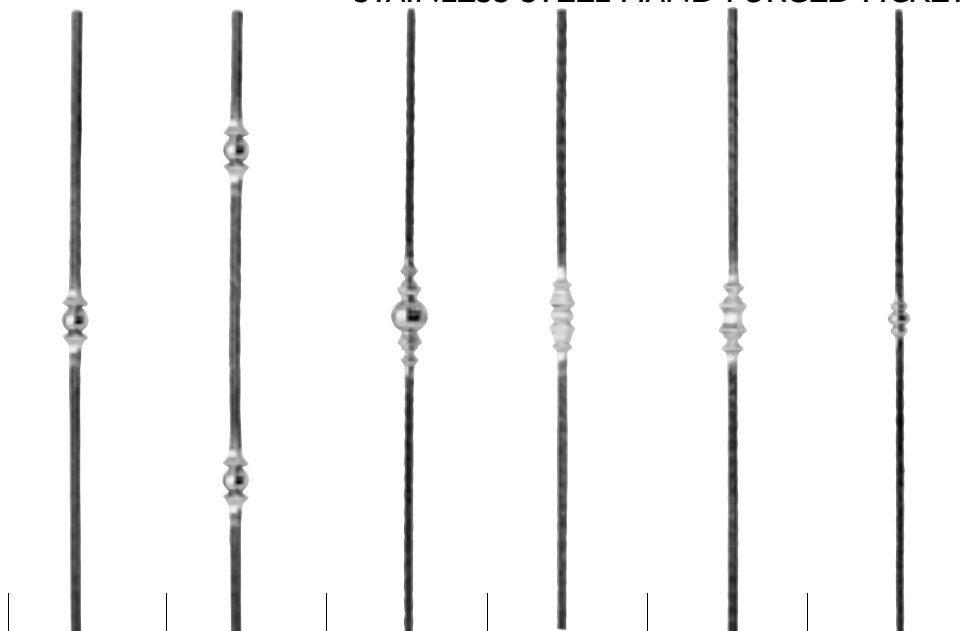

Descrizione Description	Ø 12 x 12 mm	Ø 12 x 12 mm	Ø 12 x 12 mm	Ø 12 x 12 mm	Ø 12 x 12 mm	Ø 12 x 12 mm
	Cod.art. Art.no.	Cod.art. Art.no.	Cod.art. Art.no.	Cod.art. Art.no.	Cod.art. Art.no.	Cod.art. Art.no.
Paletto Grezzo con borchia lucida <i>Unpolished picket with polished boss</i>	1419/1	1419/4	1419/2	1420/1	1420/2	1420/3
Paletto Lucido con borchia lucida <i>Polished picket with polished boss</i>	1419/1/X	1419/4/X	1419/2/X	1420/1/X	1420/2/X	1420/3/X
Paletto Grezzo con borchia lucida <i>Sandlasted picket with polished boss</i>	1419/1/Y	1419/4/Y	1419/2/Y	1420/1/Y	1420/2/Y	1420/3/Y

CAPOSALDI IN ACCIAIO INOX STAINLESS STEEL NEWEL POSTS



	Cod.art. Art.no.	Cod.art. Art.no.	Cod.art. Art.no.
Paletto Grezzo con borchia lucida <i>Unpolished picket with polished boss</i>	1416/1 Ø 25 x 25 mm 1416/2 Ø 30 x 30 mm	1416/3 Ø 25 x 25 mm 1416/4 Ø 30 x 30 mm	1416/5 Ø 25 x 25 mm 1416/6 Ø 30 x 30 mm
Paletto Lucido con borchia lucida <i>Polished picket with polished boss</i>	1416/1/X Ø 25 x 25 mm 1416/2/X Ø 30 x 30 mm	1416/3/X Ø 25 x 25 mm 1416/4/Y Ø 30 x 30 mm	1416/5/X Ø 25 x 25 mm 1416/6/X Ø 30 x 30 mm
Paletto Grezzo con borchia lucida <i>Sandlasted picket with polished boss</i>	1416/1/Y Ø 25 x 25 mm 1416/2/Y Ø 30 x 30 mm	1416/3/Y Ø 25 x 25 mm 1416/4/Y Ø 30 x 30 mm	1416/5/Y Ø 25 x 25 mm 1416/6/Y Ø 30 x 30 mm

Borchia in ottone Brass/Boss Art. 1426/A/1 Ø 40 mm H 1200 mm	Non lucidato <i>Unpolished</i> Art. 1416/10 Ø 25 x 25 mm H 1200 mm	Borchia in ottone Brass/Boss Art. 1416/9 Ø 30 mm H 1200 mm	Non lucidato <i>Unpolished</i> Art. 1416/7 Ø 25 x 25 mm H 1200 mm Art. 1416/8 Ø 30 x 30 mm H 1200 mm
-----------------------------------------------------------------------------	--------------------------------------------------------------------------------	---------------------------------------------------------------------------	---------------------------------------------------------------------------------------------------------------------------

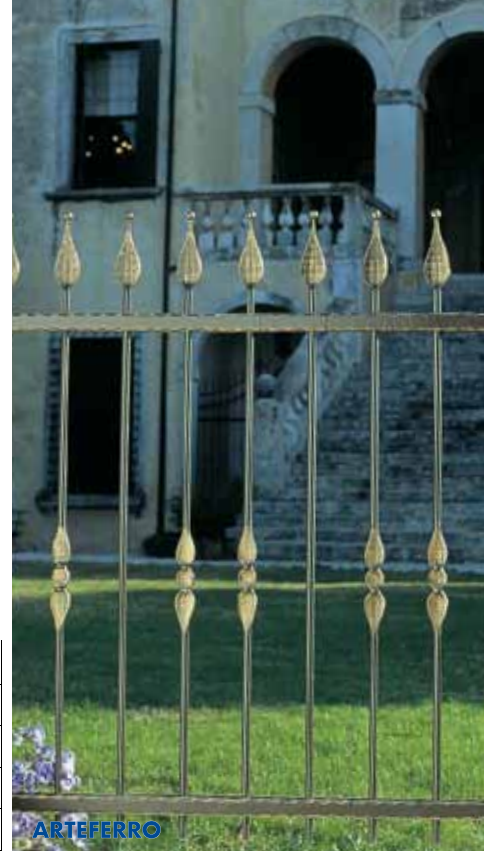

ARTEFERRO

	Φ 12 x 12 mm	Ø 12 mm	Φ 12 x 12 mm	Ø 12 mm
Altezza/Height	Cod.art./Art.no.	Cod.art./Art.no.	Cod.art./Art.no.	Cod.art./Art.no.
200 mm	1422/B/15	1422/B/14	-	-
1000 mm	1422/B/6	1422/B/8	1422/B/10	1422/B/12
1200 mm	1422/B/7	1422/B/9	1422/B/11	1422/B/13



Art. 1426/13
 Ø 30 mm
 H 120 mm
 foro/hole
 Ø 13 mm



Art. 1426/14
 Ø 30 mm
 h 150 mm
 foro/hole
 Ø 13 mm



Art. 1426/15
 Ø 30 mm
 h 150 mm
 foro/hole
 Ø 13 mm



Forgiata
 Hand forged
Art. 1425/2
 Ø 33 mm
 H 140 mm



Forgiato
 Hand forged
Art. 1425/1
 Ø 70 mm
 H 120 mm



Art. 1426/4
 Ø 115 mm
 foro/hole
 Ø 10 mm
 spess./thick. 4 mm



Art. 1426/7
 Ø 90 mm
 foro/hole
 Ø 12 mm
 spess./thick. 4 mm

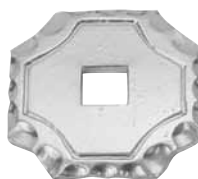

Art. 1426/5
 70 x 70 mm
 foro/hole
 12 x 12 mm
 spess./thick. 4 mm



Art. 1426/8
 75 x 75 mm
 foro/hole
 12 x 12 mm
 spess./thick. 4 mm



Art. 1426/9
 100 x 100 mm
 spess./thick. 4 mm



Art. 1426/6
 80 x 80 mm
 spess./thick. 8 mm

**SFERE FORGIATE
 IN ACCIAIO
 INOX**

**STAINLESS STEEL
 HAND FORGED
 SPHERES**

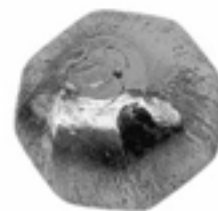

	Non lucidata Unpolished	Non lucidata Unpolished
	Cod.art./Art.no.	Cod.art./Art.no.
Ø 16 mm	1425/3	1425/3/X
Ø 20 mm	1425/4	1425/4/X
Ø 25 mm	1425/5	1425/5/X
Ø 30 mm	1425/6	1425/6/X
Ø 35 mm	1425/7	1425/7/X
Ø 40 mm	1425/8	1425/8/X
Ø 50 mm	1425/9	1425/9/X
Ø 60 mm	1425/10	1425/10/X
Ø 70 mm	1425/11	1425/11/X
Ø 80 mm	1425/12	1425/12/X
Ø 100 mm	1425/13	1425/13/X



Art. 1424/19



Art. 1423/11
Ø 53 x 9 mm
L 3000 mm
Non lucidato
Unpolished

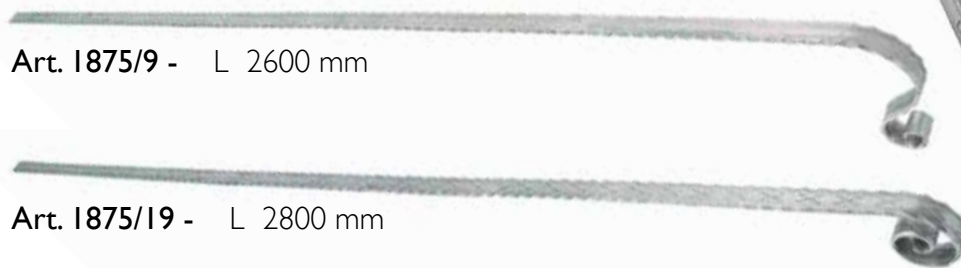

Art. 1875/9 - L 2600 mm

Art. 1875/19 - L 2800 mm



Art. 1424/18



Art. 1423/12
Ø 47 x 14 mm
L 3000 mm
Non lucidato
Unpolished

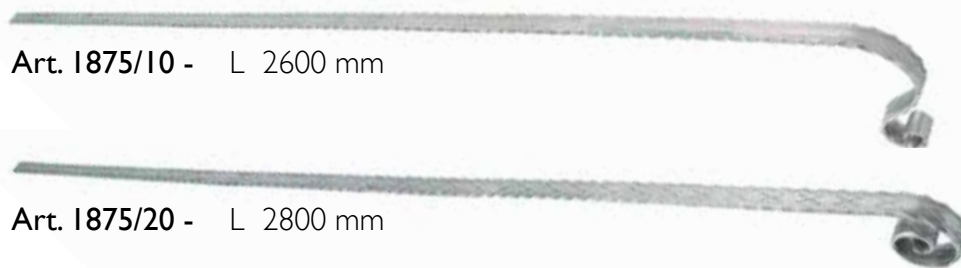

Art. 1875/10 - L 2600 mm

Art. 1875/20 - L 2800 mm



Art. 1423/1
 □ 40 x 8 mm
 L 3000 mm
 Non lucidato
 Unpolished

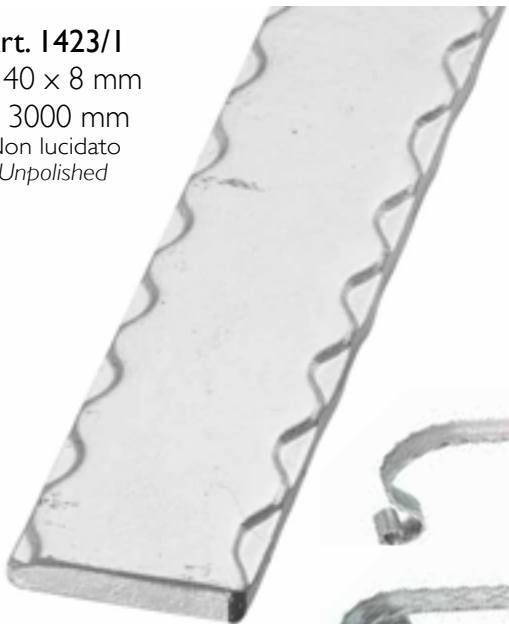

Art. 1424/1



Art. 1424/9



Art. 1875/1 - L 2600 mm

Art. 1875/11 - L 2800 mm

Art. 1423/6
 □ 40 x 8 mm
 L 3000 mm
 Non lucidato
 Unpolished



Art. 1424/6



Art. 1424/14

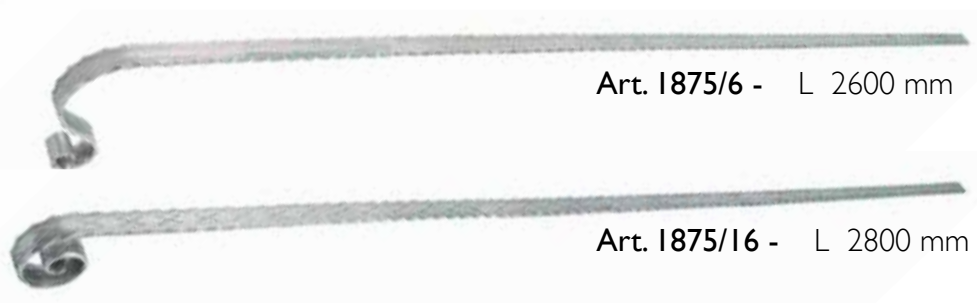

Art. 1875/6 - L 2600 mm

Art. 1875/16 - L 2800 mm

Art. 1423/5
 □ 40 x 8 mm
 L 3000 mm
 Non lucidato
 Unpolished



Art. 1424/5



Art. 1424/13

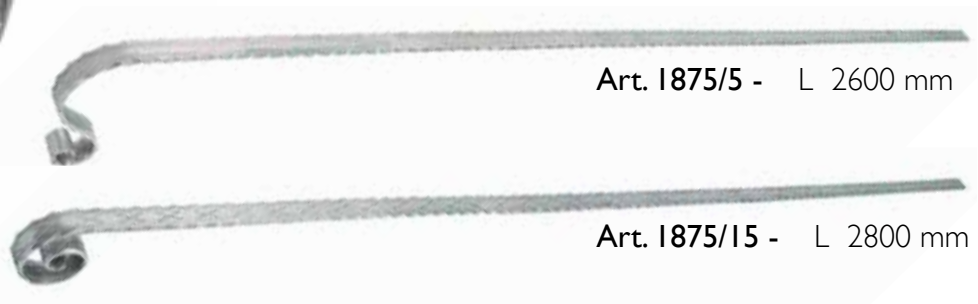

Art. 1875/5 - L 2600 mm

Art. 1875/15 - L 2800 mm



Art. I424/I6



Art. I424/8



Art. I423/8
□ 40 x 8 mm
L 3000 mm
Non lucidato
Unpolished



Art. I875/8 - L 2600 mm



Art. I875/I8 - L 2800 mm



Art. I424/I5



Art. I424/7



Art. I423/7
□ 40 x 8 mm
L 3000 mm
Non lucidato
Unpolished



Art. I875/7- L 2600 mm



Art. I875/I7 - L 2800 mm



Art. I424/I1



Art. I424/3



Art. I423/3
□ 40 x 8 mm
L 3000 mm
Non lucidato
Unpolished



Art. I875/3 - L 2600 mm



Art. I875/I3 - L 2800 mm

Art. 1423/4

40 × 8 mm
L 3000 mm
Non lucidato
Unpolished

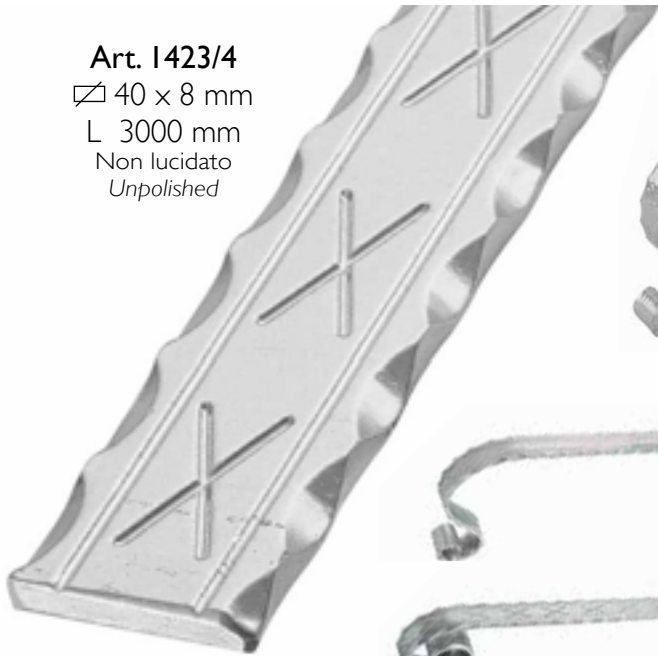

Art. 1423/4/14



Art. 1424/12



Art. 1875/4 - L 2600 mm

Art. 1875/14 - L 2800 mm

Art. 1423/2

40 × 8 mm
L 3000 mm
Non lucidato
Unpolished



Art. 1424/2



Art. 1424/10



Art. 1875/2 - L 2600 mm

Art. 1875/12 - L 2800 mm



Art. 1423/9

30 × 8 mm
L 3000 mm
Non lucidato
Unpolished
Battuto su 2 spigoli
Hammered on 2 edges



Art. 1423/10

30 × 8 mm
L 3000 mm
Non lucidato
Unpolished
Battuto su 4 spigoli e due lati
Hammered on 4 edges and 2 sides

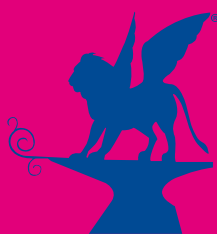

arteferro

ARTEFERRO INOX

THE STAINLESS STEEL RAILING SYSTEM

Un appropriato utilizzo degli elementi modulari che compongono la vasta gamma del "SYSTEMA INOX", (prodotta interamente e direttamente da IND.I.A. S.P.A.) permettono di creare con estrema semplicità e senza perdite di tempo, qualsiasi tipo di ringhiera di scale con risultati di estrema eleganza, offrendo nel contempo una notevole varietà di soluzioni realizzabili.

Il "SYSTEMA INOX" permette di lavorare con una velocità oggi ancora ineguagliata. Non è più necessario saldare, molare, decapare, lucidare e passivare; i singoli pezzi vengono assemblati gli uni agli altri grazie ad un sistema di inserimento ad incastro simile a quello usato nell'industria aeronautica e utilizzando le speciali colle high-tech che completano la gamma della linea "SYSTEMA INOX", si possono bloccare permanentemente. Ind.i.a. spa ha creato con questo sistema per ringhiere un punto focale nell'architettura. Si tratta di un elemento di composizione irrinunciabile per l'architettura moderna poiché si ambienta molto bene negli edifici di nuova concezione; è un prodotto altamente tecnologico, facile da gestire inserendosi in un modello estetico che si sta espandendo molto velocemente in tutto il mondo.

A proper use of the modular elements that make up the wide range of the "SYSTEMA INOX" (entirely and directly produced by IND.I.A. S.P.A.) allows to create very easily and with no waste of time any type of banister. The result would be extremely elegant and will offer at the same time the chance to realize many solutions. The "SYSTEMA INOX" allows to work at a speed unmatched so far. There is no more need to weld, grind, pickle, mirror polish nor passivate the pieces. They are assembled thanks to a joint insertion system similar to the one used in the aviation industry and to special high-tech glues that complete the range of the "SYSTEMA INOX" line. Therefore, such pieces can be fixed permanently.

With such system for banisters, Ind.i.a. spa created a focal point in the architecture. As a matter of fact, the modern architecture cannot do without such composition element since it perfectly suits the new generation buildings. Furthermore, it is an extremely high-tech product easy to handle as it fits in an aesthetic model that is quickly spreading all over the world.

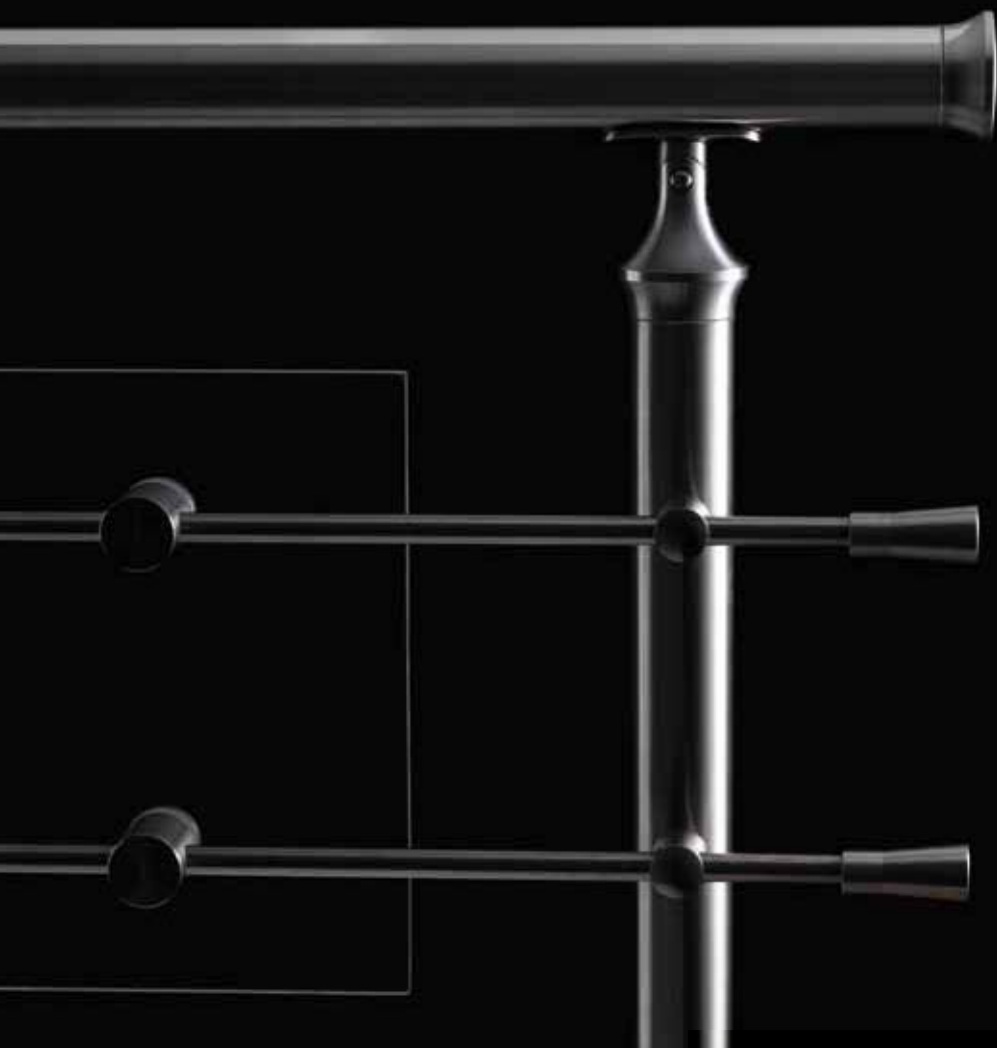

 **ind.i.a.**^{® S.P.A.}
industria italiana arteferro



Richiedeteci il nostro
catalogo completo
*Ask for our
complete catalogue*

www.arteferro.com



AISI 304	AISI 316	Iron	Dimensioni Dimensions
E0011	E4806	I0011	Ø 33,7 x 2,0 x 3000 mm
E0011/6000	E4806/6000	I0011/6000	Ø 33,7 x 2,0 x 6000 mm
E001	E4801	I001	Ø 42,4 x 2,0 x 3000 mm
E001/6000	E4801/6000	I001/6000	Ø 42,4 x 2,0 x 6000 mm
EV005/6000	EV4851/6000		Ø 12 x 0,5 x 6000 mm
EV0050/6000	EV4852/6000		Ø 14 x 0,5 x 6000 mm
EV105/6000	EV5851/6000		Ø 12 x 1,5 x 6000 mm
EV1050/6000	EV5852/6000		Ø 14 x 1,5 x 6000 mm



AISI 304	AISI 316	Iron	Dimensioni Dimensions
E0052	E4849		Ø 8 x 3000 mm
E0052/6000	E4849/6000		Ø 8 x 6000 mm
E0051	E4850	I0051	Ø 10 x 3000 mm
E0051/6000	E4850/6000	I0051/6000	Ø 10 x 6000 mm
E005	E4851	I005	Ø 12 x 3000 mm
E005/6000	E4851/6000	I005/6000	Ø 12 x 6000 mm
E0050	E4852		Ø 14 x 3000 mm
E0050/6000	E4852/6000		Ø 14 x 6000 mm



AISI 304	AISI 316	Dimensioni Dimensions
E4000406	E4010406	40 x 6 x 4000 mm



AISI 304	Lunghezza Lenght	3000 mm	AISI 304	Lunghezza Lenght	6000 mm
E00152020	20 x 20 x 1,5 mm		E06152020	20 x 20 x 1,5 mm	
E00202525	25 x 25 x 2,0 mm		E06202525	25 x 25 x 2,0 mm	
E00203030	30 x 30 x 2,0 mm		E06203030	30 x 30 x 2,0 mm	
E00204040	40 x 40 x 2,0 mm		E06204040	40 x 40 x 2,0 mm	
E00205050	50 x 50 x 2,0 mm		E06205050	50 x 50 x 2,0 mm	
E00206060	60 x 60 x 2,0 mm		E06206060	60 x 60 x 2,0 mm	

AISI 316	Lunghezza Lenght	3000 mm	AISI 316	Lunghezza Lenght	6000 mm
E10152020	20 x 20 x 1,5 mm		E16152020	20 x 20 x 1,5 mm	
E10202525	25 x 25 x 2,0 mm		E16202525	25 x 25 x 2,0 mm	
E10203030	30 x 30 x 2,0 mm		E16203030	30 x 30 x 2,0 mm	
E10204040	40 x 40 x 2,0 mm		E16204040	40 x 40 x 2,0 mm	
E10205050	50 x 50 x 2,0 mm		E16205050	50 x 50 x 2,0 mm	
E10206060	60 x 60 x 2,0 mm		E16206060	60 x 60 x 2,0 mm	

AISI 316	Lunghezza Lenght	3000 mm	AISI 316	Lunghezza Lenght	6000 mm
E10203020	30 x 20 x 2,0 mm		E16203020	30 x 20 x 2,0 mm	
E10204020	40 x 20 x 2,0 mm		E16204020	40 x 20 x 2,0 mm	
E10204030	40 x 30 x 2,0 mm		E16204030	40 x 30 x 2,0 mm	
E10205030	50 x 30 x 2,0 mm		E16205030	50 x 30 x 2,0 mm	
E10206040	60 x 40 x 2,0 mm		E16206040	60 x 40 x 2,0 mm	



AISI 304	AISI 316	Iron	Per tubo For tube
E0212	E0212316	I0212	Ø 33,7 x 2,0 mm
E0213	E0213316	I0213	Ø 42,4 x 2,0 mm



AISI 304	AISI 316	Iron	Dimensioni Dimensions
E403304	E403	I403	Ø 100 x 6 mm e 3 fori/holes Ø 11 mm
E404304	E404	I404	100 x 100 x 6 mm e 4 fori/holes Ø 11 mm



AISI 316	Per tubo For tube
E4482	Ø 33,7 x 2,0 mm
E4483	Ø 42,4 x 2,0 mm

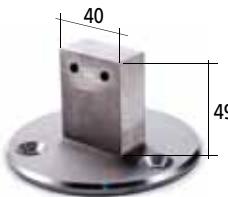

AISI 304	AISI 316	Dimensioni Dimensions
E021200	E021200316	Disco Ø 100 x 6 mm, 3 fori svasati Ø 11 mm Disc has 100 x 100 x 6 mm dia, with 3 holes 11 mm dia



AISI 304	AISI 316	Per rondino For round bar
E021310	E021310316	8 mm
E021320	E021320316	10 mm
E021330	E021330316	12 mm



ALUMINIUM Per tubo
For tube

E0131 Ø 33,7 x 2,0 mm

E013 Ø 42,4 x 2,0 mm



ALUMINIUM Per tubo
For tube

E0141 Ø 33,7 x 2,0 mm

E014 Ø 42,4 x 2,0 mm



AISI 316 Per tubo
For tube

E2066 Ø 33,7 x 2,0 mm

E456 Ø 42,4 x 2,0 mm



AISI 316 Per tubo
For tube

E4560 Ø 33,7 x 2,0 mm

E4561 Ø 42,4 x 2,0 mm



AISI 316 Per tubo
For tube

E4565 Ø 33,7 x 2,0 mm

E4566 Ø 42,4 x 2,0 mm

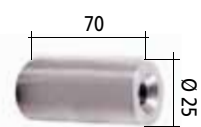

AISI 304 **AISI 316**

E112/70 E112/70316



AISI 316 Per tubo
For tube

E405 Ø 33,7 x 2,0 mm

E406 Ø 42,4 x 2,0 mm



AISI 304 **AISI 316** **Iron** Per tubo
For tube

E11410 E11410316 I11410 Ø 33,7 x 2,0 mm

E11420 E11420316 I11420 Ø 42,4 x 2,0 mm

E11440 E11440316 Superficie piana
Flat face



AISI 304 **AISI 316** **Iron** Per tubo
For tube

E11510 E11510316 I11510 Ø 33,7 x 2,0 mm

E11520 E11520316 I11520 Ø 42,4 x 2,0 mm



AISI 304 **AISI 316** Per tubo
For tube

E116 E116316 Ø 42,4 x 2,0 mm



AISI 304 **AISI 316** Dimensioni
Dimensions

E112 E112316 140 x 40 x 35 mm

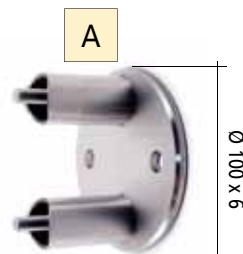

AISI 304 **AISI 316** **Iron** Per tubo
For tube

A

E40010/304 E40010 Ø 33,7 mm

E400/304 E400 I400 Ø 42,4 mm

E40020/304 E40020 Superficie piana
Flat face

B

E40110/304 E40110 Ø 33,7 mm

E401/304 E401 Ø 42,4 mm

E40120/304 E40120 Superficie piana
Flat face

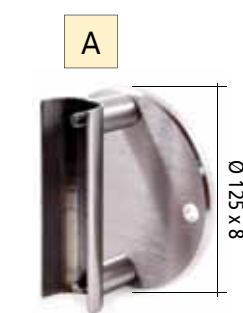

AISI 304 **AISI 316** **Iron** Per tubo
For tube

A

E111 E111316 I111 Ø 42,4 x 2,0 mm

E111/337 E111/337316 Ø 33,7 x 2,0 mm

B

E113 E113316 I113 Ø 42,4 x 2,0 mm

E113/337 E113/337316 I113/337 Ø 33,7 x 2,0 mm

E1110 E1110316 Superficie piana
Flat face



AISI 304 **AISI 316** **Iron** Per tubo
For tube

E1111 E1111316 I1111 Ø 33,7 x 2,0 mm

E1112 E1112316 I1112 Ø 42,4 x 2,0 mm



AISI 304 **AISI 316** **Iron** Per tubo
For tube

E1113 E1113316 I1113 Ø 33,7 x 2,0 mm

E1114 E1114316 I1114 Ø 42,4 x 2,0 mm



AISI 304	AISI 316	Iron	Per tubo For tube
E11310	E11310316	I11310	Ø 33,7 x 2,0 mm
E11320	E11320316	I11320	Ø 42,4 x 2,0 mm
E11340	E11340316		Superficie piana Flat face



AISI 304	Per tubo For tube
E117	Ø 42,4 x 2,0 mm

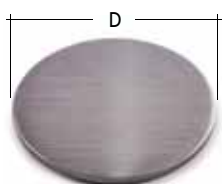

AISI 304	AISI 316	Iron	D
E060	E060316		Ø 33 x 4 mm
E061	E061316		Ø 42 x 4 mm
E062	E062316		Ø 48 x 4 mm
E063	E063316		Ø 60 x 4 mm
E0631	E4753		Ø 70 x 6 mm
E064	E064316	I064	Ø 80 x 4 mm
E065	E065316	I065	Ø 100 x 4 mm
E066	E066316		Ø 100 x 6 mm
E069	E069316		Ø 120 x 6 mm

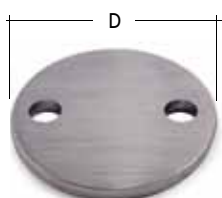

AISI 304	AISI 316	Iron	D
E0680	E0680316		Ø 70 x 6 mm
E0681	E0681316	I0681	Ø 80 x 6 mm
E0682	E0682316	I0682	Ø 100 x 6 mm
E0683	E0683316		Ø 120 x 6 mm

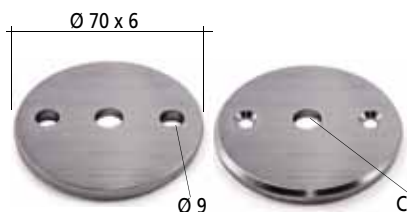

AISI 304	AISI 316	Iron	C
E0690	E4754	I0690	Ø 10,5 mm
E0690/D	E4754/D	I0690/D	Ø 10,5 mm

Fori con svassi e perimetro bisellato
Countersunk holes and chamfered perimeter



AISI 304	AISI 316	Iron	D	Fori esterni External holes	Foro centrale Central hole
E0695	E4755	I0695	Ø 70 x 6 mm	3 x Ø 9 mm	Ø 10,5 mm
E0695/D	E4755/D	I0695/D	Ø 70 x 6 mm	3 x Ø 9 mm	Ø 10,5 mm
E0700	E0700316		Ø 100 x 6 mm	3 x Ø 9 mm	Ø 13 mm

Fori con svassi e perimetro bisellato
Countersunk holes and chamfered perimeter

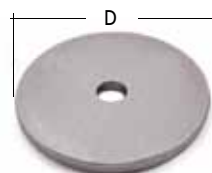

AISI 304	AISI 316	D	Foro centrale Central hole
E0600	E0600316	Ø 100 x 6 mm	Ø 13 mm



AISI 304	AISI 316	Iron	D	Fori esterni External holes	Foro centrale Central hole
E0691	E0691316	I0691	Ø 100 x 6 mm	2 x Ø 9 mm	Ø 43 mm
E0693	E0693316		Ø 120 x 6 mm	2 x Ø 11 mm	Ø 43 mm
E0691/D	E0691316/D	I0691/D	Ø 100 x 6 mm	2 x Ø 9 mm	Ø 43 mm

Fori con svassi e perimetro bisellato
Countersunk holes and chamfered perimeter



AISI 304	AISI 316	Iron	D	Fori esterni External holes	Foro centrale Central hole
E0696	E4751	I0696	Ø 100 x 6 mm	3 x Ø 9 mm	Ø 43 mm
E06961	E47511	I06961	Ø 100 x 6 mm	3 x Ø 9 mm	Ø 34,5 mm
E0698	E4757	I0698	Ø 120 x 6 mm	3 x Ø 11 mm	Ø 34 mm
E0696/D	E4751/D	I0696/D	Ø 100 x 6 mm	3 x Ø 9 mm	Ø 43 mm
E06961/D	E47511/D	I06961/D	Ø 100 x 6 mm	3 x Ø 9 mm	Ø 34,5 mm

Fori con svassi e perimetro bisellato
Countersunk holes and chamfered perimeter



AISI 304	Iron	Dimensioni Dimensions
E050	I050	Ø 33,7 mm
E051	I051	Ø 42,4 mm

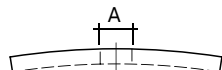

Spess. /Thick. 6 mm

AISI 304	AISI 316	Iron	Fori esterni External holes	A
E0631/5	E0631316/5	I0631/5	No	Ø 10,5 mm
E0690/5	E0690316/5	I0690/5	2 x Ø 6,5 mm	Ø 10,5 mm
E0695/5	E0695316/5	I0695/5	3 x Ø 6,5 mm	Ø 10,5 mm

AISI 304	AISI 316	Ø F Foro centrale Dia. F Central holes	Dimensioni Dimensions	Fori esterni External holes
E08410	E08410316	43 mm	82 x 62 mm	2 x Ø 11 mm
E08420	E08420316	34,5 mm	82 x 62 mm	2 x Ø 11 mm
E08450	E08450316	12 mm	82 x 62 mm	2 x Ø 11 mm
E08460	E08460316	10 mm	82 x 62 mm	2 x Ø 11 mm



Spess. /Thick. 6 mm

ALUMINIUM	Dimensioni Dimensions	Fori esterni External holes	Foro interno Internal hole
E015	Ø 55 mm	3 x Ø 6 mm	Ø 11 mm
E016	Ø 75 mm	3 x Ø 6 mm	Ø 11 mm
E017	Ø 95 mm	3 x Ø 6 mm	Ø 11 mm

AISI 304	AISI 316	Ø F Foro centrale Dia. F Central holes	Dimensioni Dimensions	Fori esterni External holes
E08510	E08510316	43 mm	70 x 70 mm	4 x Ø 11 mm
E08520	E08520316	34,5 mm	70 x 70 mm	4 x Ø 11 mm
E08550	E08550316	12 mm	70 x 70 mm	4 x Ø 11 mm
E08560	E08560316	10 mm	70 x 70 mm	4 x Ø 11 mm



Spess. /Thick. 6 mm

Spess. /Thick. 6 mm

AISI 304	AISI 316	Ø F Foro centrale Dia. F Central holes	Dimensioni Dimensions	Fori esterni External holes
E08110	E08110316	43 mm	87,5 x 90 mm	3 x Ø 11 mm
E08120	E08120316	34,5 mm	87,5 x 90 mm	3 x Ø 11 mm
E08150	E08150316	12 mm	87,5 x 90 mm	3 x Ø 11 mm
E08160	E08160316	10 mm	87,5 x 90 mm	3 x Ø 11 mm

AISI 304	AISI 316	Ø F Foro centrale Dia. F Central holes	Dimensioni Dimensions	Fori esterni External holes
E08610	E08610316	43 mm	80 x 60 mm	3 x Ø 11 mm
E08620	E08620316	34,5 mm	80 x 60 mm	3 x Ø 11 mm
E08650	E08650316	12 mm	80 x 60 mm	3 x Ø 11 mm
E08660	E08660316	10 mm	80 x 60 mm	3 x Ø 11 mm



Spess. /Thick. 6 mm

AISI 304	AISI 316	Ø F Foro centrale Dia. F Central holes	Dimensioni Dimensions	Fori esterni External holes
E08210	E08210316	43 mm	81,5 x 90 mm	3 x Ø 11 mm
E08220	E08220316	34,5 mm	81,5 x 90 mm	3 x Ø 11 mm
E08250	E08250316	12 mm	81,5 x 90 mm	3 x Ø 11 mm
E08260	E08260316	10 mm	81,5 x 90 mm	3 x Ø 11 mm

AISI 304	AISI 316	Iron	Dimensioni Dimensions	Foro Hole	Altezza Height
E0184	E0184316		Ø 76 mm	Ø 43,0 mm	12 mm
E0191	E0191316	I0191	Ø 85 mm	Ø 34,5 mm	15 mm
E0192	E0192316	I0192	Ø 85 mm	Ø 41,0 mm	15 mm
E019	E019316	I019	Ø 85 mm	Ø 43,0 mm	15 mm
E020/S	E4072/S		Ø 105 mm	Ø 34,5 mm	15 mm
E0202	E4074	I0202	Ø 105 mm	Ø 34,5 mm	25 mm
E020	E4072	I020	Ø 105 mm	Ø 43,0 mm	15 mm
E020/C	E4072/C	I020/C	Ø 105 mm	Ø 43,0 mm	25 mm
E0201			Ø 105 mm	Ø 49,0 mm	15 mm
E0201/C	E4073		Ø 105 mm	Ø 49,0 mm	25 mm
E0203		I0203	Ø 129 mm	Ø 43,0 mm	25 mm
E0204	E4075		Ø 129 mm	Ø 49,0 mm	25 mm
E02011	E40731		Ø 105 mm	Ø 51,5 mm	25 mm
	E4076		Ø 145 mm	Ø 49,0 mm	25 mm
	E4077		Ø 145 mm	Ø 61,0 mm	25 mm
E0180	E0180316		Ø 45 mm	Ø 12,5 mm	10 mm
E018			Ø 62 mm	Ø 20,5 mm	15 mm
E0181	E0181316	I0181	Ø 62 mm	Ø 12,5 mm	15 mm
E0182	E4070	I0182	Ø 76 mm	Ø 12,5 mm	12 mm
E0183	E4071		Ø 76 mm	Ø 14,5 mm	12 mm

Spess. /Thick. 6 mm

AISI 304	AISI 316	Ø F Foro centrale Dia. F Central holes	Dimensioni Dimensions	Fori esterni External holes
E08310	E08310316	43 mm	96 x 60 mm	4 x Ø 11 mm
E08320	E08320316	34,5 mm	96 x 60 mm	4 x Ø 11 mm
E08350	E08350316	12 mm	96 x 60 mm	4 x Ø 11 mm
E08360	E08360316	10 mm	96 x 60 mm	4 x Ø 11 mm



AISI 304	AISI 316	Iron	D	Foro Hole	Altezza Height
E02061	E02061316	I02061	85 mm	Ø 34,5 mm	25 mm
E02062	E02062316	I02062	85 mm	Ø 43,0 mm	25 mm
E02063	E02063316	I02063	105 mm	Ø 34,5 mm	25 mm
E02064	E02064316	I02064	105 mm	Ø 43,0 mm	25 mm

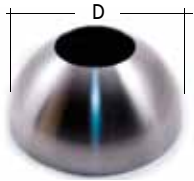

AISI 304	AISI 316	Iron	D	Foro Hole	Altezza Height
E02065	E02065316	I02065	85 mm	Ø 34,5 mm	38 mm
E02066	E02066316	I02066	85 mm	Ø 43,0 mm	38 mm
E02067	E02067316	I02067	105 mm	Ø 34,5 mm	48 mm
E02068	E02068316	I02068	105 mm	Ø 43,0 mm	48 mm

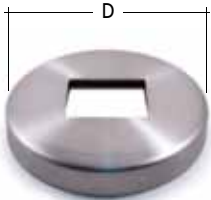

AISI 304	AISI 316	Iron	D	Foro Hole	Altezza Height
E0205	E0205316	I0205	Ø 105 mm	33 x 41 mm	15 mm

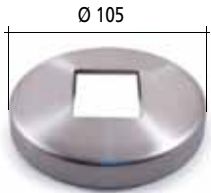

AISI 304	AISI 316	Iron	Foro Hole	Altezza Height
E02051	E02051316	I02051	41 x 41 mm	15 mm



AISI 316	Dimensioni Dimensions	Foro Hole	Altezza Height
E02052316	105 x 105 mm	41 x 41 mm	15 mm



AISI 304	AISI 316	Iron	Descrizione Description
E0222	E0222316	I0222	Senza filetto Without thread



AISI 304	AISI 316	Iron
E0224	E0224316	I0224

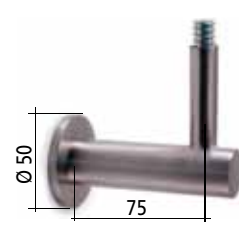

AISI 316	Per corrimano For handrail
E4586	Ø 40 ÷ 48 mm e quadro

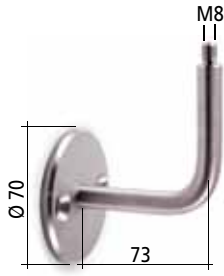

AISI 304	AISI 316	Iron
E02241	E02241316	I02241



AISI 303	Dimensioni Dimensions
E0221	Ø 80 x 5 mm



AISI 304	AISI 316	Iron
E0223	E0223316	I0223



AISI 304	AISI 316	Iron	Dimensioni Dimensions
E034100	E034100316	I034100	66 x 82 mm



AISI 304	AISI 316	Iron
E02231	E02231316	I02231



AISI 303	AISI 316	Iron	Dimensioni Dimensions
E022/S1	E022/S1316	I022/S1	Vetro da forare Ø 21 mm Glass to be drilled 21 mm dia.



AISI 316	Per tubo For tube
E459	Ø 42,4 - 33,7 mm



AISI 303	AISI 316	Iron	Dimensioni Dimensions
E022/S2	E022/S2316	I022/S2	Vetro da forare Ø 21 mm Glass to be drilled 21 mm dia.

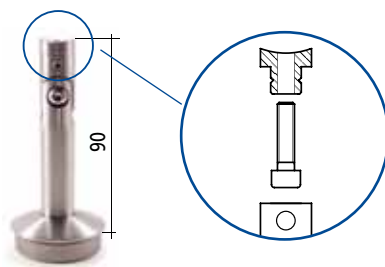

AISI 303	AISI 316	Iron	Per tubo For tube	AISI 303	AISI 316	Iron	Per tubo For tube	AISI 303	AISI 316	Iron	Per tubo For tube
E0301	E0301316	I0301	Ø 33,7 x 2,0 mm	E038600	E038610	I038600	Ø 33,7 x 2,0 mm	E039400	E039410	I039400	Ø 33,7 x 2,0 mm
E030/S	E030/S316	I030/S	Ø 42,4 x 2,0 mm	E038700	E038710	I038700	Ø 42,4 x 2,0 mm	E039500	E039510	I039500	Ø 42,4 x 2,0 mm

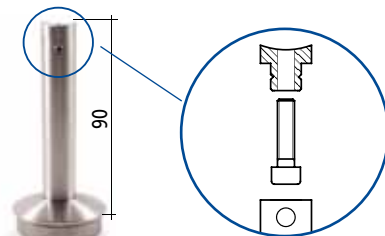

AISI 303	AISI 316	Iron	Per tubo For tube	AISI 303	AISI 316	Iron	Per tubo For tube	AISI 303	AISI 316	Iron	Per tubo For tube
E0311	E0311316	I0311	Ø 33,7 x 2,0 mm	E038400	E038410	I038400	Ø 33,7 x 2,0 mm	E039600	E039610	I039600	Ø 33,7 x 2,0 mm
E031/S1	E031/S1316	I031/S1	Ø 42,4 x 2,0 mm	E038500	E038510	I038500	Ø 42,4 x 2,0 mm	E039700	E039710	I039700	Ø 42,4 x 2,0 mm



AISI 303	AISI 316	Iron	Per tubo For tube	AISI 303	AISI 316	Iron	Per tubo For tube	AISI 303	AISI 316	Iron	Per tubo For tube
E038000	E038010	I038000	Ø 33,7 x 2,0 mm	E039000	E039010	I039000	Ø 33,7 x 2,0 mm	E039800	E039810	I039800	Ø 33,7 x 2,0 mm
E038100	E038110	I038100	Ø 42,4 x 2,0 mm	E039100	E039110	I039100	Ø 42,4 x 2,0 mm	E039900	E039910	I039900	Ø 42,4 x 2,0 mm



AISI 303	AISI 316	Iron	Per tubo For tube	AISI 303	AISI 316	Iron	Per tubo For tube
E039200	E039210	I039200	Ø 33,7 x 2,0 mm	E040000	E040010	I040000	Ø 33,7 x 2,0 mm
E039300	E039310	I039300	Ø 42,4 x 2,0 mm	E040100	E040110	I040100	Ø 42,4 x 2,0 mm



AISI 303	AISI 316	Iron	Per tubo For tube	AISI 303	AISI 316	Iron	Per tubo For tube	AISI 304	Per tubo For tube
E038200	E038210	I038200	Ø 33,7 x 2,0 mm	E038800	E038810	I038800	Ø 33,7 x 2,0 mm	E030	Ø 42,4 x 2,0 mm
E038300	E038310	I038300	Ø 42,4 x 2,0 mm	E038900	E038910	I038900	Ø 42,4 x 2,0 mm		



AISI 304 Per tubo
For tube

E031 Ø 42,4 x 2,0 mm



AISI 303 **AISI 316** **Iron** Per tubo
For tube

E040600 E040610 I040600 Ø 33,7 x 2,0 mm

E040700 E040710 I040700 Ø 42,4 x 2,0 mm

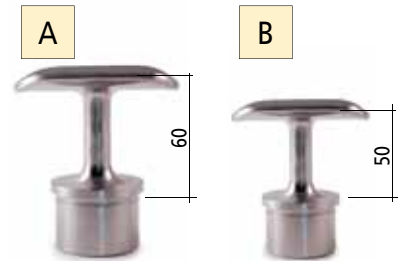

AISI 316 Per tubo
For tube

A
E458/40 Ø 40,0 x 2,0 mm

B
E458 Ø 42,4 x 2,0 mm

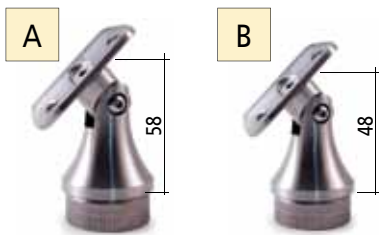

AISI 303 **AISI 316** **Iron** Per tubo
For tube

A
E0104 E0104316 I0104 Ø 42,4 x 2,0 mm

B
E0105 E0105316 I0105 Ø 33,7 x 2,0 mm



AISI 303 **AISI 316** **Iron** Per tubo
For tube

E040800 E040810 I040800 Ø 33,7 x 2,0 mm

E040900 E040910 I040900 Ø 42,4 x 2,0 mm



AISI 316 Per tubo
For tube

E500/424 Ø 42,4 x 2,0 mm

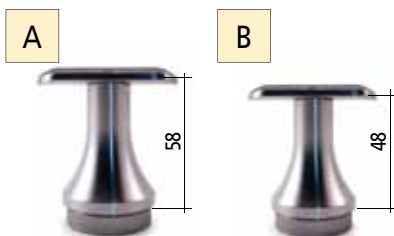

AISI 303 **AISI 316** **Iron** Per tubo
For tube

A
E0102 E0102316 I0102 Ø 42,4 x 2,0 mm

B
E0103 E0103316 I0103 Ø 33,7 x 2,0 mm



AISI 303 **AISI 316** **Iron** Per tubo
For tube

E041000 E041010 I041000 Ø 33,7 x 2,0 mm

E041100 E041110 I041100 Ø 42,4 x 2,0 mm



AISI 316 Per tubo
For tube

E510/424 Ø 42,4 x 2,0 mm



AISI 303 **AISI 316** **Iron** Per tubo
For tube

E040200 E040210 I040200 Ø 33,7 x 2,0 mm

E040300 E040310 I040300 Ø 42,4 x 2,0 mm



AISI 303 **AISI 316** **Iron** Per tubo
For tube

E041200 E041210 I041200 Ø 33,7 x 2,0 mm

E041300 E041310 I041300 Ø 42,4 x 2,0 mm



AISI 304 **AISI 316** Per tondino
For round bar

E050100 E050110 8 mm
E050200 E050210 10 mm
E050300 E050310 12 mm



AISI 303 **AISI 316** **Iron** Per tubo
For tube

E040400 E040410 I040400 Ø 33,7 x 2,0 mm

E040500 E040510 I040500 Ø 42,4 x 2,0 mm



AISI 316 Per tubo
For tube

E4581/40 Ø 40,0 x 2,0 mm

E4581 Ø 42,4 x 2,0 mm



AISI 304	AISI 316	Per tubo For tube
E051100	E051110	Ø 33,7 mm
E051200	E051210	Ø 42,4 mm

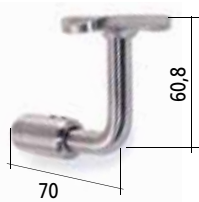

AISI 316	Per tubo For tube
E4583	attacco piano square
E4583/424	Ø 42,4 mm



AISI 304	AISI 316	Iron	Per tubo For tube
E011974	E011974316	I011974	Ø 33,7 mm Ø 42,4 mm



AISI 303	AISI 316	H	Per tubo For tube
E0210	E0210316	71,5 mm	Ø 33,7 mm
E021/S	E021/S316	72 mm	Ø 42,4 mm



AISI 304	AISI 316	Iron	H
E041400	E041500	I041400	64 mm



AISI 304	AISI 316	Iron	Per tubo For tube
E011971	E011971316	I011971	Ø 33,7 mm Ø 42,4 mm



AISI 316	Per tubo For tube
E468/337	Ø 33,7 mm
E468/424	Ø 42,4 mm



AISI 316	H	Per tubo For tube
E4540	60 mm	Ø 33,7 mm
E4541	67 mm	Ø 42,4 mm



AISI 304	AISI 316	Iron	H
E041410	E041510	I041500	65 mm



AISI 303	AISI 316	Per tubo For tube	Foro passante Through hole
E01195100	E02195100	Ø 33,7 mm	Ø 12,2 mm
E01196100	E02196100	Ø 42,4 mm	Ø 12,2 mm



AISI 303	AISI 316	Iron	Dimensioni Dimensions
E0225	E0225316	I0225	Ø 12 x 125 mm
E0226	E0226316	I0226	Ø 14 x 125 mm



AISI 304	AISI 316	Iron	Per tubo For tube
E01197	E01197316	I01197	Ø 33,7 mm Ø 42,4 mm



AISI 304	AISI 316	Iron	Descrizione Description
E011931	E011931316	I011931	Ø 12 x 65 mm
E01193	E01193316	I01193	Ø 14 x 65 mm



AISI 316	Per tubo For tube
E4584	attacco piano square
E4584/424	Ø 42,4 mm



AISI 304	AISI 316	Iron	Per tubo For tube
E011976	E011976316	I011976	Superficie piana Flat face



AISI 304	AISI 316	Iron	Descrizione Description
E011941	E011941316	I011941	Ø 12 x 65 mm
E01194	E01194316	I01194	Ø 14 x 65 mm
E011943	E011943316	I011943	Ø 12 x 115 mm
E011944	E011944316	I011944	Ø 14 x 115 mm



AISI 304	AISI 316	Iron	Descrizione Description
E011945	E011945316	I011945	Ø 12 x 80 mm
E0119451	E0119451316	I0119451	Ø 14 x 80 mm
E011940	E011940316	I011940	Ø 12 x 115 mm testa arrotondata rounded head
E0119441	E0119441316	I011944	Ø 14 x 115 mm testa arrotondata rounded head

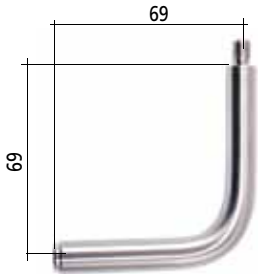

AISI 304	AISI 316	Iron	Descrizione Description
E011946	E011946316	I011946	Con filetto interno M6 e filetto esterno M8 With internal thread M6 and external thread M8

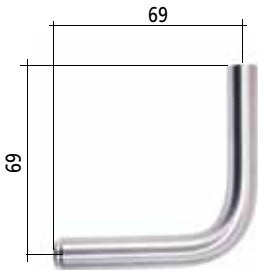

AISI 304	AISI 316	Iron	Descrizione Description
E011947	E011947316	I011947	Con 1 filetto interno M6 With 1 internal thread M6

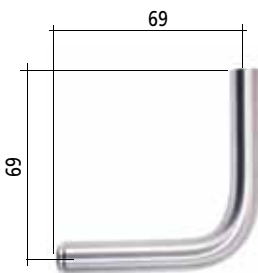

AISI 304	AISI 316	Iron	Descrizione Description
E011948	E011948316	I011948	Con filetti interni M6 With internal threads M6



AISI 304	AISI 316	Iron	Descrizione Description
E01192	E01192316	I01192	90 x 75 mm



AISI 304	Dimensioni Dimensions
E080	Fino a/Up to 1200 mm
E081	Fino a/Up to 1500 mm
E082	Fino a/Up to 1800 mm
E083	Fino a/Up to 2000 mm
E084	Fino a/Up to 2500 mm
E085	Fino a/Up to 3000 mm
E086	Fino a/Up to 4000 mm



AISI 304	AISI 316	ZAMAC	Per tubo For tube	A
	E2001		Ø 33,7 x 2,0 mm	55 mm
E450/304	E450	I450	Ø 42,4 x 2,0 mm	65 mm



AISI 316	Per tubo For tube
E447	Ø 33,7 x 2,0 mm
E447/26	Ø 33,7 x 2,6 mm
E4471	Ø 42,4 x 2,0 mm
E4471/26	Ø 42,4 x 2,6 mm



AISI 304	AISI 316	ZAMAC	Per tubo For tube	A
	E2011		Ø 33,7 x 2,0 mm	55 mm
E451/304	E451	I451	Ø 42,4 x 2,0 mm	65 mm



AISI 316	ZAMAC	Per tubo For tube	A
E2016		Ø 33,7 x 2,0 mm	25 mm
E2019		Ø 40,0 x 2,0 mm	50 mm
E2015	I2015	Ø 42,4 x 2,0 mm	50 mm



AISI 316	Per tubo For tube	A
E2031	Ø 33,7 x 2,0 mm	55 mm
E2034	Ø 40,0 x 2,0 mm	70 mm
E203	Ø 42,4 x 2,0 mm	70 mm



AISI 316	ZAMAC	Per tubo For tube	A
E4464		Ø 33,7 x 2,0 mm	43 mm
E446	I446	Ø 42,4 x 2,0 mm	53 mm



AISI 304	AISI 316	Per tubo For tube
E700		Ø 21,3 x 1,6 mm
E704	E800	Ø 33,7 x 2,0 mm
E706	E802	Ø 42,4 x 2,0 mm

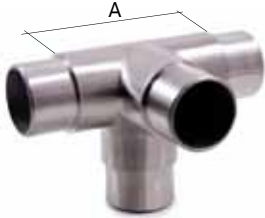

AISI 316	Per tubo For tube	A
E2036	Ø 33,7 x 2,0 mm	76 mm
E2035	Ø 42,4 x 2,0 mm	89 mm



AISI 316	Per tubo For tube
E449	Ø 33,7 x 2,0 mm
E4491	Ø 42,4 x 2,0 mm



AISI 304	AISI 316	Per tubo For tube
E721	E821	Ø 33,7 x 2,0 mm
E722	E822	Ø 42,4 x 2,0 mm

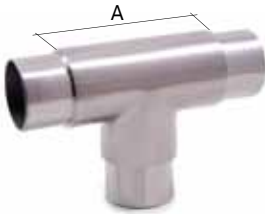

AISI 316	ZAMAC	Per tubo For tube	A
E2041		Ø 33,7 x 2,0 mm	76 mm
E453/40		Ø 40,0 x 2,0 mm	87 mm
E453	I453	Ø 42,4 x 2,0 mm	87 mm



AISI 316	Per tubo For tube
E2061	Ø 33,7 x 2,0 mm
E455	Ø 42,4 x 2,0 mm
E2062	Ø 42,4 x 2,6 mm



AISI 316	Per tubo For tube	A
E440	Ø 42,4 x 2,0 mm Ø 33,7 x 2,0 mm	



AISI 316	Per tubo For tube
E455100	Ø 33,7 x 2,0 mm
E455200	Ø 42,4 x 2,0 mm



AISI 316	Per tubo For tube	B
E2046	Ø 33,7 x 2,0 mm	75 mm
E2049	Ø 40,0 x 2,0 mm	87 mm
E2045	Ø 42,4 x 2,0 mm	87 mm



OTTONE	Per tubo For tube
E024	Ø 42,4 x 2,0 mm
E0241	Ø 33,7 x 2,0 mm



ARTEFERRO



AISI 303	AISI 316	Iron	Foro Hole A	Descrizione Description
E006	E006316	I006	Ø 12,2 mm	Passante Through
E0061		I0061	Ø 12,2 mm	Cieco - sx Blind - L
E0062		I0062	Ø 12,2 mm	Cieco - dx Blind - L
E0066	E0066316		Ø 14,2 mm	Passante Through
E0067			Ø 14,2 mm	Cieco - sx Blind - L
E0068			Ø 14,2 mm	Cieco - dx Blind - R
E00666		I00666	Ø 12,2 mm	Passante - Through Solo per tubo quadro Only for square tube

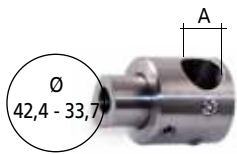

AISI 303	AISI 316	Iron	Foro Hole A	Descrizione Description
E0063	E0063316	I0063	Ø 10,2 mm	Passante Through
E0064	E0064316	I0064	Ø 10,2 mm	Cieco - sx Blind - L
E0065	E0065316	I0065	Ø 10,2 mm	Cieco - dx Blind - R

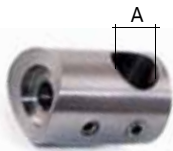

AISI 303	AISI 316	Iron	Per tubo For tube	Foro Hole A
E0069101	E0069101316	I0069101	Ø 33,7 mm	Ø 10,2 mm passante through
E006911	E006911316	I006911	Ø 33,7 mm	Ø 12,2 mm passante through
E006913	E006913316		Ø 33,7 mm	Ø 14,2 mm passante through
E006910	E006910316	I006910	Ø 42,4 mm	Ø 10,2 mm passante through
E0069	E4042	I0069	Ø 42,4 mm	Ø 12,2 mm passante through
E00691	E4040		Ø 42,4 mm	Ø 14,2 mm passante through
E006917	E40440			Superficie piana Flat face Ø 10,2 mm passante through
E00692	E4044	I00692		Superficie piana Flat face Ø 12,2 mm passante through
E006921	E4045			Superficie piana Flat face Ø 14,2 mm passante through
E006923	E40491		Ø 42,4 mm	Ø 10,2 mm cieco dx blind right
E006924	E40490		Ø 42,4 mm	Ø 10,2 mm cieco sx blind left
E0069100	E40493	I0069100	Ø 42,4 mm	Ø 12,2 mm cieco dx blind right
E006922	E40492	I006922	Ø 42,4 mm	Ø 12,2 mm cieco sx blind left

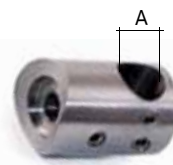

AISI 303	AISI 316	Per tubo For tube	Foro Hole A
E00692100	E40422100	Ø 33,7 mm	Ø 10,2 mm passante - through
E00692200	E40422200	Ø 33,7 mm	Ø 12,2 mm passante - through
E00692300	E40422300	Ø 33,7 mm	Ø 14,2 mm passante - through
E00693100	E40423100	Ø 42,4 mm	Ø 10,2 mm passante - through
E00693200	E40423200	Ø 42,4 mm	Ø 12,2 mm passante - through
E00693300	E40423300	Ø 42,4 mm	Ø 14,2 mm passante - through
E00693000	E40423000	Superficie piana Flat face	

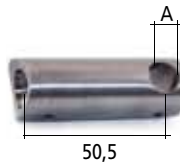

AISI 303	AISI 316	Iron	Per tubo For tube	Foro Hole A
E006931	E006931316	I006931	Ø 42,4 mm	Ø 12,2 mm
E00693	E00693316		Ø 42,4 mm	Ø 14,2 mm
E006934	E006934316	I006934	Superficie piana Flat face	Ø 12,2 mm
E006935	E006935316		Superficie piana Flat face	Ø 14,2 mm

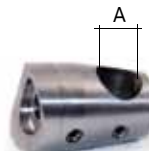

AISI 303	AISI 316	Iron	Per tubo For tube	Foro Hole A
E00698100	E40428100	I00698100	Ø 33,7 mm	Ø 10,2 mm
E00698200	E40428200	I00698200	Ø 33,7 mm	Ø 12,2 mm
E00698300	E40428300	I00698300	Ø 42,4 mm	Ø 10,2 mm
E00698400	E40428400	I00698400	Ø 42,4 mm	Ø 12,2 mm



AISI 303	AISI 316	Iron	Per tubo For tube	Foro Hole A
E00699100	E40429100	I00691100	Ø 33,7 mm	Ø 10,2 mm
E00699200	E40429200	I00691200	Ø 33,7 mm	Ø 12,2 mm
E00699300	E40429300	I00691300	Ø 42,4 mm	Ø 10,2 mm
E00699400	E40429400	I00691400	Ø 42,4 mm	Ø 12,2 mm



AISI 303	AISI 316	Iron	Foro Hole A	Foro Hole B
E006965		I006965	Ø 12,2 mm	Ø 10,2 mm
E006966	E006966316	I006966	Ø 12,2 mm	Ø 12,2 mm
E006976	E006976316	I006976	Ø 14,2 mm	Ø 12,2 mm
E00696			Ø 16,2 mm	Ø 12,2 mm
E006977	E006977316		Ø 14,2 mm	Ø 14,2 mm
E00697			Ø 16,2 mm	Ø 14,2 mm
E006978			Ø 16,2 mm	Ø 16,2 mm



AISI 303	AISI 316	Foro Hole
E01	E01316	Ø 8,2 mm
E02	E02316	Ø 10,2 mm
E03	E03316	Ø 12,2 mm
E04	E04316	Ø 14,2 mm



AISI 303	AISI 316	Descrizione Description
E05	E05316	Senza foro Without hole



AISI 303	AISI 316	Iron	Foro Hole A
E00611	E40611		Ø 10,2 mm
E00600	E40600	I00600	Ø 12,2 mm
E00610	E40610		Ø 14,2 mm



AISI 303	AISI 316	Per tubo For tube	Foro Hole A
E006941	E006941316	Superficie piana - Flat face	Ø 10,2 mm
E00694	E00694316	Superficie piana - Flat face	Ø 12,2 mm
E00695	E00695316	Superficie piana - Flat face	Ø 14,2 mm



AISI 303	AISI 316	Iron	Per tubo For tube	Foro Hole A
E00697110	E40427110	E00697100	Ø 33,7 mm Ø 42,4 mm	Ø 10,2 mm
E00697210	E40427210	E00697200	Ø 33,7 mm Ø 42,4 mm	Ø 12,2 mm



AISI 303	AISI 316	Iron	Per tubo For tube	Foro Hole A
E00696100	E40426100	I00696100	Ø 33,7 mm	Ø 10,2 mm
E00696200	E40426200	I00696200	Ø 33,7 mm	Ø 12,2 mm
E00696300	E40426300	I00696300	Ø 42,4 mm	Ø 10,2 mm
E00696400	E40426400	I00696400	Ø 42,4 mm	Ø 12,2 mm
E00696500	E40426500		Ø 42,4 mm	Ø 14,2 mm

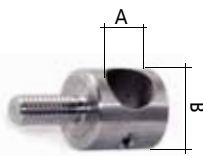

AISI 303	AISI 316	Iron	Foro Hole A	B
E00621	E00621316	I00621	Ø 8,2 mm	Ø 16 mm
E00620	E00620316	I00620	Ø 10,2 mm	Ø 16 mm
E00622	E00622316		Ø 12,2 mm	Ø 18 mm



AISI 303	AISI 316	Iron	Per tubo For tube A	Tondino Round bar B
E01654	E41654		Ø 33,7 mm	Ø 12,2 mm
E01651	E41651	I40650	Ø 42,4 mm	Ø 12,2 mm
E01652	E41652		Ø 33,7 mm	Ø 10,2 mm
E01653	E41653		Ø 42,4 mm	Ø 10,2 mm



AISI 303	AISI 316	Iron	Per tubo For tube	Tondino Round bar B
E00654	E40654	I00654	Superficie piana - Flat face	Ø 10,2 mm
E00651	E40651	I00651	Superficie piana - Flat face	Ø 12,2 mm
E00652	E40652		Superficie piana - Flat face	Ø 14,2 mm

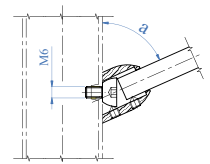

AISI 303	Iron	Per tubo For tube	Tondino Round bar B	a°
E0069991	I0069991	Ø 42,4 mm	Ø 12 mm	22-33
E0069994		Ø 42,4 mm	Ø 14 mm	25-29
E0069997	I0069997	Ø 33,7 mm	Ø 12 mm	22-33
E0069990		Ø 33,7 mm	Ø 14 mm	25-29



AISI 303	Iron	Per tubo For tube	Tondino Round bar B
E006999	I006999	Ø 42,4 mm	Ø 12 mm
E0069993		Ø 42,4 mm	Ø 14 mm
E0069996	I0069996	Ø 33,7 mm	Ø 12 mm
E0069999		Ø 33,7 mm	Ø 14 mm

Regolabile - Adjustable



AISI 303	AISI 316	Iron	Per tubo For tube	Tondino Round bar	B
E0075	E0075316		Ø 42,4 mm	Ø 14 mm	
E0074	E0074316	I0074	Ø 42,4 mm	Ø 12 mm	
E0073	E0073316	I0073	Ø 42,4 mm	Ø 10 mm	
E0077	E0077316		Ø 33,7 mm	Ø 14 mm	
E0076	E0076316	I0076	Ø 33,7 mm	Ø 12 mm	
E0078	E0078316	I0078	Ø 33,7 mm	Ø 10 mm	
E0079	E0079316		Sup. piana Flat face	Ø 14 mm	
E00791	E00791316	I00791	Sup. piana Flat face	Ø 12 mm	
E00792	E00792316	I00792	Sup. piana Flat face	Ø 10 mm	

AISI 303	AISI 316	Iron	Tondino Round bar	A
E0170	E0170316	I0170	Ø 10 mm	
E0171	E0171316		Ø 12 mm	
E0172	E0172316	I0172	Ø 14 mm	

AISI 303	AISI 316	Iron	Tondino Round bar	A
E00700	E00700316	I00700	Ø 12 mm	
E00710	E00710316	I00710	Ø 14 mm	
E00720	E00720316		Ø 10 mm	



**SUPPORTI PER VETRO
CERTIFICATI E TESTATI**
CERTIFIED AND TESTED
GLASS CLAMPS



AISI 316	Dimensioni Dimensions	Per tubo For tube	Spessore vetro Glass thick.
E00970	53 x 68 mm	Ø 33,7 mm	12,76 mm
E00971	53 x 68 mm	Ø 42,4 mm	12,76 mm
E00973	53 x 60 mm	Superficie piana - Flat face	12,76 mm



AISI 316	Dimensioni Dimensions	Per tubo For tube	Spessore vetro Glass thick.
E00941	43 x 48 mm	Ø 33,7 mm	8 e/and 10 mm
E00921	43 x 48 mm	Ø 42,4 mm	8 e/and 10 mm
E00931	43 x 43 mm	Superficie piana - Flat face	8 e/and 10 mm



AISI 316	Dimensioni Dimensions	Per tubo For tube	Spessore vetro Glass thick.
E00913	38 x 53 mm	Ø 33,7 mm	8 e/and 10 mm
E00912	38 x 53 mm	Ø 42,4 mm	8 e/and 10 mm
E00911	38 x 49 mm	Superficie piana - Flat face	8 e/and 10 mm



AISI 316	Dimensioni Dimensions	Per tubo For tube	Spessore vetro Glass thick.
E0092	53 x 58 mm	Ø 42,4 mm	8 e/and 10 mm
E0093	53 x 53 mm	Superficie piana - Flat face	8 e/and 10 mm



AISI 316	Dimensioni Dimensions	Per tubo For tube	Spessore vetro Glass thick.
E009	43 x 64 mm	Ø 42,4 mm	8 e/and 10 mm
E0091	43 x 60 mm	Superficie piana - Flat face	8 e/and 10 mm
E00960	43 x 64 mm	Ø 42,4 mm	10 e/and 12 mm
E00962	43 x 60 mm	Superficie piana - Flat face	10 e/and 12 mm



AISI 316	Dimensioni Dimensions	Per tubo For tube	Spessore vetro Glass thick.
E00980	53 x 60 mm	Ø 33,7 mm	10 e/and 12 mm
E00981	53 x 60 mm	Ø 42,4 mm	10 e/and 12 mm
E00983	53 x 53 mm	Superficie piana - Flat face	10 e/and 12 mm

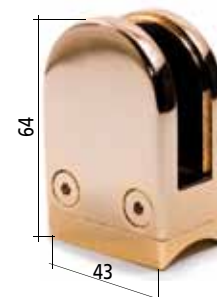
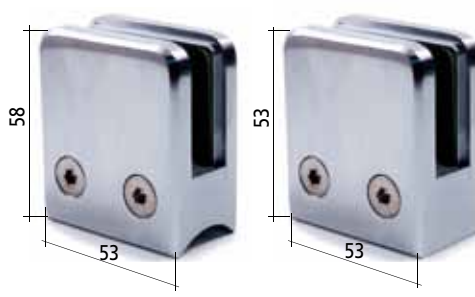
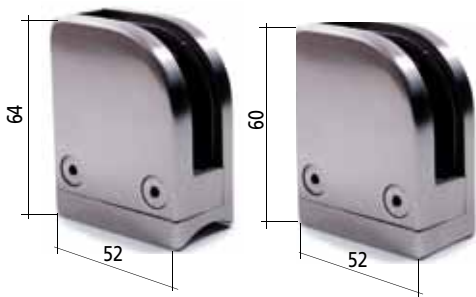

AISI 316

Per tubo
For tube

Spessore vetro
Glass thick.

E00950	Ø 42,4 mm sx	8 e/and 10 mm
E00952	Superficie piana sx Flat face left	8 e/and 10 mm

EFFETTO INOX - STAINLESS STEEL EFFECT

ZAMAC

Per tubo
For tube

Spessore vetro
Glass thick.

E00860	Ø 33,7 mm	8 e/and 10 mm
E00861	Ø 42,4 mm	8 e/and 10 mm
E00862	Superficie piana Flat face	8 e/and 10 mm

EFFETTO DORATO - GOLD PLATED

ZAMAC

Per tubo
For tube

Spessore vetro
Glass thick.

E00730	Ø 42,4 mm	8 e/and 10 mm
--------	-----------	---------------

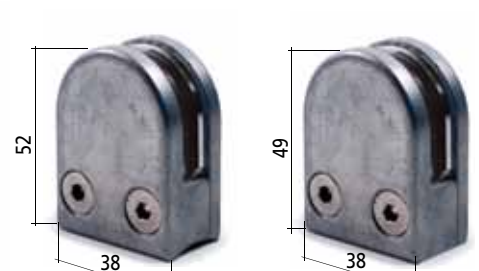
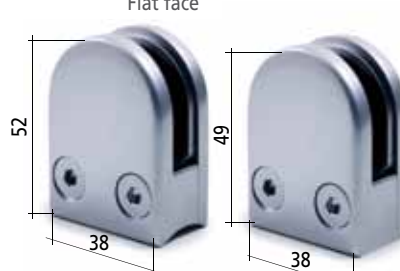
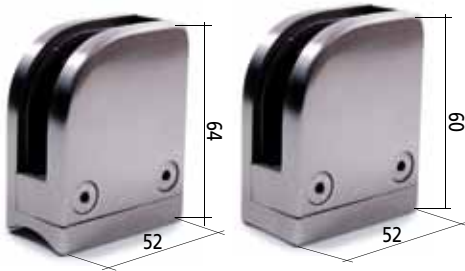

AISI 316

Per tubo
For tube

Spessore vetro
Glass thick.

E00955	Ø 42,4 mm dx	8 e/and 10 mm
E00957	Superficie piana dx Flat face right	8 e/and 10 mm

CROMATO SATINATO - SATIN CHROME

ZAMAC

Per tubo
For tube

Spessore vetro
Glass thick.

E00750	Ø 33,7 mm	6 e/and 8 mm
E00751	Ø 42,4 mm	6 e/and 8 mm
E00752	Superficie piana Flat face	6 e/and 8 mm

GREZZO - RAW FINISH

ZAMAC

Per tubo
For tube

Spessore vetro
Glass thick.

E00742	Ø 33,7 mm	6 e/and 8 mm
E00741	Ø 42,4 mm	6 e/and 8 mm
E00743	Superficie piana Flat face	6 e/and 8 mm

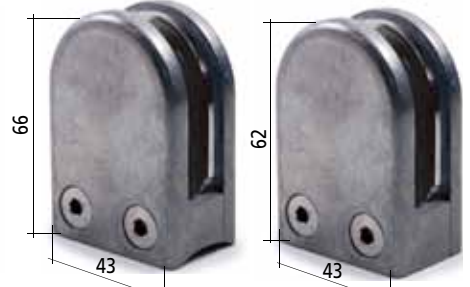
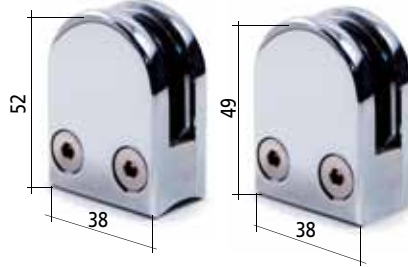
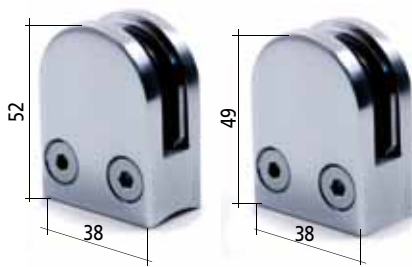

EFFETTO INOX - STAINLESS STEEL EFFECT

ZAMAC

Per tubo
For tube

Spessore vetro
Glass thick.

E00851	Ø 33,7 mm	6 e/and 8 mm
E00850	Ø 42,4 mm	6 e/and 8 mm
E00852	Superficie piana Flat face	6 e/and 8 mm

CROMATO LUCIDO - POLISHED CHROME

ZAMAC

Per tubo
For tube

Spessore vetro
Glass thick.

E00737	Ø 33,7 mm	6 e/and 8 mm
E00736	Ø 42,4 mm	6 e/and 8 mm
E00738	Superficie piana Flat face	6 e/and 8 mm

GREZZO - RAW FINISH

ZAMAC

Per tubo
For tube

Spessore vetro
Glass thick.

E007401	Ø 42,4 mm	8 e/and 10 mm
E00740	Superficie piana Flat face	8 e/and 10 mm

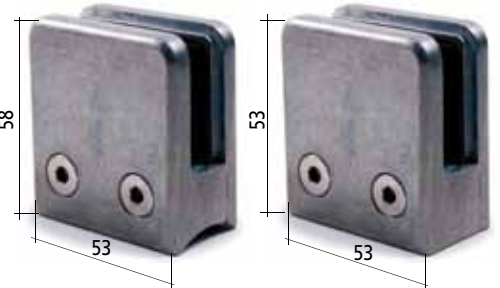
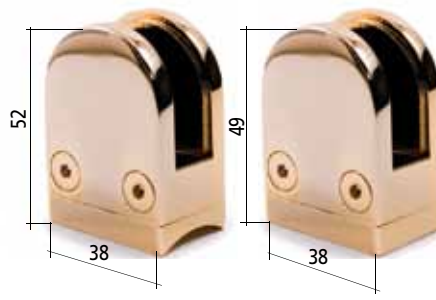
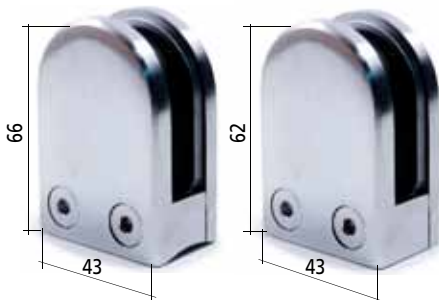

EFFETTO INOX - STAINLESS STEEL EFFECT

ZAMAC

Per tubo
For tube

Spessore vetro
Glass thick.

E00872	Ø 33,7 mm	8 e/and 10 mm
E00871	Ø 42,4 mm	8 e/and 10 mm
E00870	Superficie piana Flat face	8 e/and 10 mm

EFFETTO DORATO - GOLD PLATED

ZAMAC

Per tubo
For tube

Spessore vetro
Glass thick.

E00732	Ø 33,7 mm	8 e/and 10 mm
E00731	Ø 42,4 mm	8 e/and 10 mm
E00733	Superficie piana Flat face	8 e/and 10 mm

GREZZO - RAW FINISH

ZAMAC

Per tubo
For tube

Spessore vetro
Glass thick.

E00760	Ø 42,4 mm	8 e/and 10 mm
E00762	Superficie piana Flat face	8 e/and 10 mm



SUPPORTI PER VETRO
CERTIFICATI E TESTATI

BREVETTATA - PATENTED

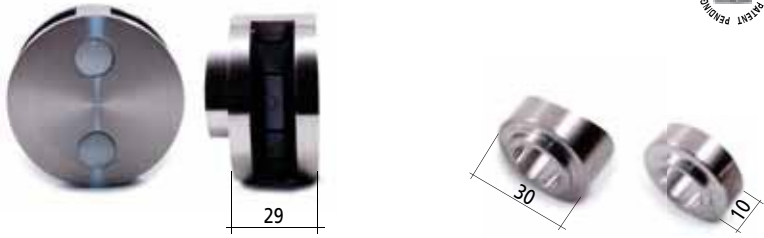

AISI 316	Dimensioni Dimensions	Spessore vetro Glass thickness	AISI 316	Per tubo For tube
E00840	Ø 60 mm	8 mm	E00841	Ø 33,7 mm
X00840 lucido mirror polished	Ø 60 mm	8 mm	E00842	Ø 42,4 mm
			E00843	Superficie piana - Flat face



N 2 per pezzi per set
No. 2 of pieces in set

Da utilizzare con articoli:
To use with these article numbers:
E00820 - E00821 - E00820316 - E00821316
E00830 - E00831 E00830316 - E00831316
-E00840



AISI 316	Descrizione Description	Rubber	Per Vetro For Glass
E00840/C	Chiusura in acciaio inox satinato per creare un supporto circolare con un vetro Stainless steel closure satin finished, fundamental to obtain a glass holder for just one glass	E00840/R1	8,76 mm
		E00840/R2	10 mm
		E00840/R3	10,76 mm
X00840/C lucido mirror polished		E00840/R4	12 mm
		E00840/R5	12,76 mm

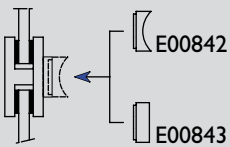

L'ANCORAGGIO INTERCAMBIABILE PERMETTE DI ADATTARLO A QUALSIASI TUBO!
THE INTERCHANGEABLE CLAMP CAN BE USED WITH ALMOST ANY TUBE!

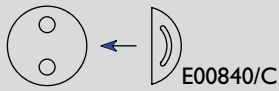

LA CHIUSURA LATERALE TI PERMETTE DI TRASFORMARLO IN UN SUPPORTO DA VETRO SINGOLO
LATERAL LOCKING PERMITS TRANSFORM TO A SINGLE GLASS SUPPORT

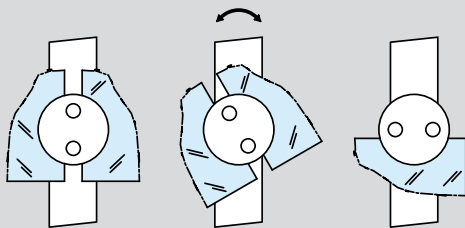

L'ANCORAGGIO MOBILE TI PERMETTE DI RUOTARE I VETRI RISPETTO AL MONTANTE
THE MOVABLE CLAMP PERMITS ROTATION OF THE GLASS A ROUND MOUNTED POST

- FACILE DA INSTALLARE • ECONOMICO • SICURO
- EASY TO INSTALL • ECONOMICAL • SAFE



CERTIFIED AND TESTED
GLASS CLAMPS

BREVETTATA - PATENTED



AISI 304	AISI 316	Spessore vetro Glass thickness
E0099100	E0099	variabile adjustable
2 piastre laterali di fissaggio 1 set gommini vetro monostrato 1 set gommini vetro bi-strato 4 viti M 6		2 side fixing plates 1 set of one-layer rubbers for glass 1 set of two-layer rubbers for glass 4 M6 screws



Adattatori da combinare con le piastre laterali compresa spina di sicurezza in acciaio

Adapters to combine with side plates
Stainless steel safety pin included

AISI 316	Cod. art. Art. no.	Spessore vetro Glass thickness	Per tubo For tube
	E99P8	8 - 8,76 mm	Superficie piana Flat face
	E9933P8	8 - 8,76 mm	Ø 33,7 mm
	E9942P8	8 - 8,76 mm	Ø 42,4 mm
	E9950P8	8 - 8,76 mm	Ø 50,8 mm
	E99P10	10 - 10,76 mm	Superficie piana Flat face
	E9933P10	10 - 10,76 mm	Ø 33,7 mm
	E9942P10	10 - 10,76 mm	Ø 42,4 mm
	E9950P10	10 - 10,76 mm	Ø 50,8 mm
	E99P12	12 - 12,76 mm	Superficie piana Flat face
	E9933P12	12 - 12,76 mm	Ø 33,7 mm
	E9942P12	12 - 12,76 mm	Ø 42,4 mm
	E9950P12	12 - 12,76 mm	Ø 50,8 mm



AISI 316	Cod. art. Art. no.	Spessore vetro Glass thickness	Per tubo For tube
	E99P16	16,76 - 17,52	Superficie piana Flat face
	E9942P16	16,76 - 17,52	Ø 42,4 mm
	E9950P16	16,76 - 17,52	Ø 50,8 mm
	E99P20	20,76 - 21,52	Superficie piana Flat face
	E9942P20	20,76 - 21,52	Ø 42,4 mm
	E9950P20	20,76 - 21,52	Ø 50,8 mm

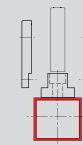
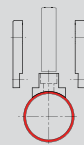

L'ANCORAGGIO INTERCAMBIABILE PERMETTE DI ADATTARLO A QUALSIASI TUBO!
THE INTERCHANGEABLE CLAMP CAN BE USED WITH ALMOST ANY TUBE!

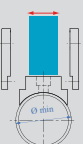
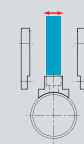

A SECONDA DELLO SPESSORE DELL'ANCORAGGIO INTERCAMBIABILE SI PUO' VARIARE LO SPESSORE DEL VETRO DA MONTARE
THE THICKNESS OF THE GLASS THAT MUST BE ASSEMBLED CAN BE CHANGED ACCORDING TO THE THICKNESS OF THE INTERCHANGEABLE ANCHORAGE

- FACILE DA INSTALLARE • ECONOMICO • SICURO
- EASY TO INSTALL • ECONOMICAL • SAFE

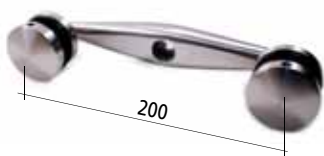

AISI 304	AISI 316	Per vetro For glass
----------	----------	------------------------

E00880 E00880316 da 8,76 a 13,52 mm
from 8,76 to 13,52 mm

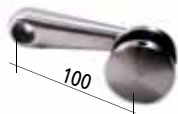

AISI 304	AISI 316	Per vetro For glass
----------	----------	------------------------

E00881 E00881316 da 8,76 a 13,52 mm
from 8,76 to 13,52 mm



AISI 304	AISI 316	Per tubo For tube
----------	----------	----------------------

E00882 E00882316 Ø 42,4 mm

E00883 E00883316 Superficie piana
Flat face

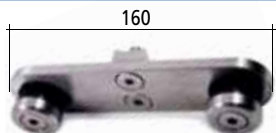

AISI 304	AISI 316	Per tubo For tube	Spessore vetro Glass thickness
----------	----------	----------------------	-----------------------------------

E00891 E00891316 Ø 33,7 mm da 8,76 a 13,52 mm
from 8,76 to 13,52 mm

E00892 E00892316 Ø 42,4 mm da 8,76 a 13,52 mm
from 8,76 to 13,52 mm

E00893 E00893316 Superficie piana
Flat face da 8,76 a 13,52 mm
from 8,76 to 13,52 mm



AISI 304	AISI 316	Per tubo For tube	Spessore vetro Glass thickness
----------	----------	----------------------	-----------------------------------

E00895 E00895316 Ø 33,7 mm da 8,76 a 13,52 mm
from 8,76 to 13,52 mm

E00896 E00896316 Ø 42,4 mm da 8,76 a 13,52 mm
from 8,76 to 13,52 mm

E00897 E00897316 Superficie piana
Flat face da 8,76 a 13,52 mm
from 8,76 to 13,52 mm



AISI 304	AISI 316	Iron	Spessore vetro Glass thickness
----------	----------	------	-----------------------------------

E2200100 E2200200 da/from 8 -12,76 mm

E2200300 E2200400 da/from 16,76 -21,52 mm

AISI 304	AISI 316	Iron	Spessore vetro Glass thickness
----------	----------	------	-----------------------------------

I2200100 da/from 8 -23 mm



AISI 304	AISI 316	Iron	Foro Hole
----------	----------	------	--------------

E4032/304 E4032 I4032 Ø 12,2 mm

E4031/304 E4031 I4031 Ø 14,2 mm

E4030/304 E4030 I4030 Ø 16,2 mm



AISI 316	Iron	Per tubo For tube
----------	------	----------------------

E40000/SO I40000/SO Ø 42,4 mm



AISI 303	AISI 316	Iron	Per tubo For tube
----------	----------	------	----------------------

E40550304 E40550 I40550 Ø 33,7 mm

E40560304 E40560 I40560 Ø 42,4 mm

E40570304 E40570 I40570 Sup. piana
Flat face



AISI 316	Iron	Per tubo For tube
----------	------	----------------------

E40581 I40581 Ø 42,4 mm

E40583 I40583 Sup. piana
Flat face



AISI 304	AISI 316	Iron	Spes. vetro Glass thick.
----------	----------	------	-----------------------------

E2000100 E2000200 I2000100 12 e/and
17,52 mm

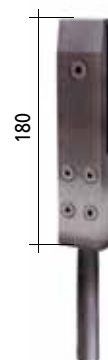

AISI 304	AISI 316	Iron	Sp. vetro Glass Thic.
----------	----------	------	--------------------------

E2100100 E2100200 I2100100 12 e/and
17,52 mm



AISI 304	AISI 316	Per tubo For tube	Sp. vetro Glass Thic.
----------	----------	----------------------	--------------------------

E00820 E00820316 Ø 42,4 mm 8 mm

E00821 E00821316 Sup. piana
Flat face 8 mm



AISI 304	AISI 316	Per tubo For tube	Sp. vetro Glass Thic.
----------	----------	----------------------	--------------------------

E00830 E00830316 Ø 42,4 mm 8 mm

E00831 E00831316 Sup. piana
Flat face 8 mm



AISI 303	Iron	Per tubo For tube
----------	------	----------------------

E0115	I0115	Ø 33,7 x 2,0 mm
E01151	I01151	Ø 42,4 x 2,0 mm



AISI 316	Iron	Per tubo For tube	H
----------	------	----------------------	---

E4139	I4139	Ø 33,7 x 2,0 mm	6,5 mm
E4141	I4141	Ø 42,4 x 2,0 mm	9 mm



AISI 316	Per tubo For tube	H
----------	----------------------	---

E4110	Ø 42,4 x 2,0 mm	
-------	-----------------	--



AISI 316	Per tubo For tube
----------	----------------------

E41451	Ø 33,7 x 2,0 mm
E4146	Ø 42,4 x 2,0 mm



AISI 316	Iron	Per tubo For tube	H
----------	------	----------------------	---

E4143	I4143	Ø 33,7 x 2,0 mm	6 mm
E4144	I4144	Ø 42,4 x 2,0 mm	9 mm



AISI 316	Per tubo For tube	H
----------	----------------------	---

E4115	Ø 33,7 x 2,0 mm	7 mm
E4120	Ø 42,4 x 2,0 mm	9 mm



AISI 316	Iron	Per tubo For tube
----------	------	----------------------

E4148	I4148	Ø 33,7 x 2,0 mm
E4149	I4149	Ø 42,4 x 2,0 mm



AISI 303	Iron	Per tubo For tube	H
----------	------	----------------------	---

E01195	I01195	Ø 33,7 x 2,0 mm	6 mm
E01196	I01196	Ø 42,4 x 2,0 mm	9 mm

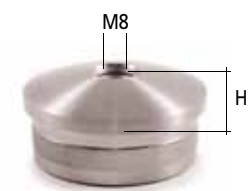

AISI 316	Per tubo For tube	H
----------	----------------------	---

E4116	Ø 33,7 x 2,0 mm	5 mm
E4130	Ø 42,4 x 2,0 mm	7 mm



AISI 303	Per tubo For tube
----------	----------------------

E01157	Ø 33,7 x 2,0 mm
E01158	Ø 42,4 x 2,0 mm



AISI 303	AISI 316	Iron	Per tubo For tube
----------	----------	------	----------------------

E01195/122	E02195/122	I01195/122	Ø 33,7 x 2,0 mm
E01196/122	E02196/122	I01196/122	Ø 42,4 x 2,0 mm



AISI 303	AISI 316	Iron	Per tubo For tube	H
----------	----------	------	----------------------	---

E01111	E02111	I01111	Ø 33,7 x 2,0 mm	17 mm
E01112	E02112	I01112	Ø 42,4 x 2,0 mm	20 mm



AISI 303	Iron	Per tubo For tube
----------	------	----------------------

E0117	I0117	Ø 33,7 x 2,0 mm
E0119	I0119	Ø 42,4 x 2,0 mm



AISI 303	AISI 316	Iron	Per tubo For tube
----------	----------	------	----------------------

E01195100	E02195100	I01195100	Ø 33,7 x 2,0 mm
E01196100	E02196100	I01196100	Ø 42,4 x 2,0 mm

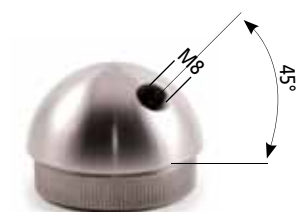

AISI 303	AISI 316	Iron	Per tubo For tube
----------	----------	------	----------------------

E01211	E02211	I01211	Ø 33,7 x 2,0 mm
E01212	E02212	I01212	Ø 42,4 x 2,0 mm



AISI 303	AISI 316	Per tubo For tube
----------	----------	----------------------

E0118	E0118316	Ø 12,0 x 0,5 mm
E01181	E01181316	Ø 14,0 x 0,5 mm
E01182	E01182316	Ø 12,0 x 1,5 mm
E01183	E01183316	Ø 14,0 x 1,5 mm



AISI 316	Per tubo For tube
----------	----------------------

E4100	Ø 42,4 x 2,0 mm
-------	-----------------



AISI 303	AISI 316	Iron	Per tubo For tube
----------	----------	------	----------------------

E0111	E0111316	I0111	Ø 33,7 x 2,0 mm
E011	E011316	I011	Ø 42,4 x 2,0 mm



AISI 303	Iron	Per tubo For tube
E0119010	I0119010	Ø 33,7 x 2,0 mm
E0119020	I0119020	Ø 42,4 x 2,0 mm

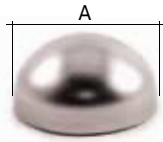

AISI 304	Diametro Diameter	A
E040	Ø 33,7 mm	
E041	Ø 42,4 mm	



AISI 316	Per tubo For tube
E2021	Ø 33,7 x 2,0 mm
E452	Ø 42,4 x 2,0 mm



AISI 303	Iron	Per tubo For tube
E0119110	I0119110	Ø 33,7 x 2,0 mm
E0119120	I0119120	Ø 42,4 x 2,0 mm



AISI 316	Per tubo For tube	Spessore tubo Tube thicknes	A
E4090	Ø 42,4 mm	2,0 - 2,6 mm	
E40956	Ø 33,7 mm	1,6 - 2,6 mm	
E316	Ø 42,4 mm	1,5 - 2,6 mm	
E315	Ø 33,7 mm	1,5 - 2,6 mm	



AISI 316	Per tubo For tube	A	H
E457	Ø 33,7 mm	Ø 70 mm	Ø 103 mm
E4571	Ø 42,4 mm	Ø 80 mm	Ø 115 mm



AISI 303	Iron	Per tubo For tube	B
E0119210	I0119210	Ø 33,7 x 2,0 mm	44 mm
E0119220	I0119220	Ø 42,4 x 2,0 mm	54 mm



AISI 316	Per tubo For tube	A
E460	Ø 33,7 mm	Ø 48 mm
E461	Ø 42,4 mm	Ø 55 mm

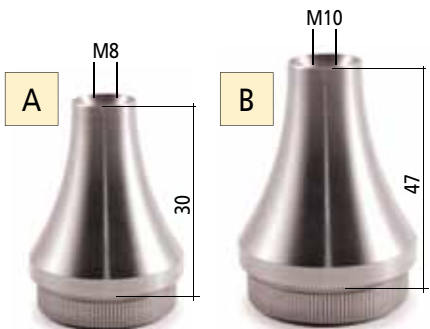

AISI 303	Iron	Per tubo For tube
A		
E0101	I0101	Ø 33,7 x 2,0 mm
B		
E010	I010	Ø 42,4 x 2,0 mm



AISI 303	Iron	Per tubo For tube
E0119310	I0119310	Ø 33,7 x 2,0 mm
E0119320	I0119320	Ø 42,4 x 2,0 mm



AISI 303	Iron	Per tubo For tube
E0119410	I0119410	Ø 33,7 x 2,0 mm
E0119420	I0119420	Ø 42,4 x 2,0 mm

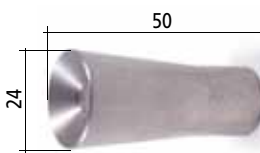

AISI 303	Iron	Per rondino For round bar
E910510	I910510	Ø 12 mm
E9105	I9105	Ø 14 mm



AISI 316	Per tubo For tube
E464	Ø 33,7 x 2,0 mm
E464/26	Ø 33,7 x 2,6 mm
E465	Ø 42,4 x 2,0 mm
E465/26	Ø 42,4 x 2,6 mm



AISI 316	Per tubo For tube	Dimensioni Dimensions	B x A
E480	Ø 33,7 x 2,0 mm	70 x 57 mm	
E481	Ø 42,4 x 2,0 mm	80 x 60 mm	

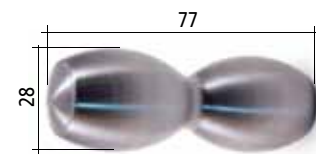

AISI 303	Iron	Per rondino For round bar
E911010	I911010	Ø 12 mm
E9110	I9110	Ø 14 mm

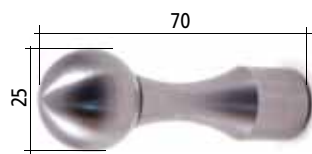

AISI 303	Iron	Per rondino For round bar
E912010	I912010	Ø 12 mm
E9120	I9120	Ø 14 mm

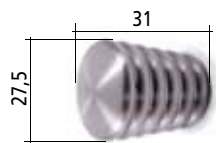

AISI 303	Iron	Per rondino For round bar
E911510	I911510	Ø 12 mm
E9115	I9115	Ø 14 mm

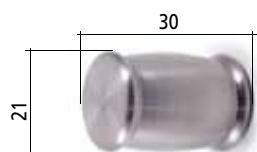

AISI 303	Iron	Per rondino For round bar
E912510	I912510	Ø 12 mm
E9125	I9125	Ø 14 mm

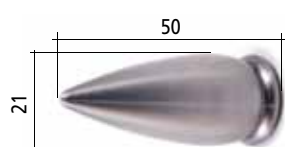

AISI 303	Iron	Per rondino For round bar
E913010	I913010	Ø 12 mm
E9130	I9130	Ø 14 mm



grezzo - raw

AISI 304	Dimensioni Dimensions
E039	30 x 30 mm
E0391	40 x 40 mm
E0392	50 x 50 mm
E0393	60 x 60 mm
E0394	80 x 80 mm
E0395	100 x 100 mm
E0396	120 x 120 mm
E0397	150 x 150 mm



AISI 316	Per tubo For tube
E4165	90 x 90 mm 3 9/16" x 3 9/16"



satinato - satin finish

AISI 316	Dimensioni Dimensions
E4150	30 x 30 mm
E4151	40 x 40 mm
E4152	50 x 50 mm
E4153	60 x 60 mm
E4154	80 x 80 mm
E4155	100 x 100 mm

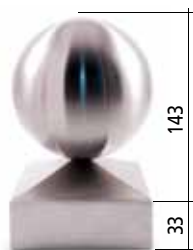

AISI 316	Per tubo For tube
E4160	90 x 90 mm - 3 9/16" x 3 9/16"



lucido - mirror polished

AISI 304	Dimensioni Dimensions	Filetto Thread
E0701/HP	Ø 30 mm	M 6
E0702/HP	Ø 40 mm	M 6
E070/HP	Ø 50 mm	M 6
E071/HP	Ø 60 mm	M 8
E072/HP	Ø 70 mm	M 8
E073/HP	Ø 80 mm	M 8
E074/HP	Ø 90 mm	M 8
E075/HP	Ø 100 mm	M 10
E076/HP	Ø 120 mm	M 10



dorato - gold plated

AISI 304	Dimensioni Dimensions	Filetto Thread
E0701/GO	Ø 30 mm	M 6
E0702/GO	Ø 40 mm	M 6
E070/GO	Ø 50 mm	M 6
E071/GO	Ø 60 mm	M 8
E073/GO	Ø 80 mm	M 8
E075/GO	Ø 100 mm	M 10
E076/GO	Ø 120 mm	M 10



satinato - satin finish

AISI 304	AISI 316	Dimensioni Dimensions	Filetto Thread
E0701		Ø 30 mm	M6
E0702		Ø 40 mm	M6
E070		Ø 50 mm	M6
E071		Ø 60 mm	M8
E072304	E072	Ø 70 mm	M8
E073		Ø 80 mm	M8
E074		Ø 90 mm	M8
E075304	E075	Ø 100 mm	M10
E076		Ø 120 mm	M10
E077		Ø 150 mm	M10
E078		Ø 200 mm	M10



AISI 303	AISI 316	Iron	Dimensioni Dimensions	Filetto Thread
E012	E4300	I012	Ø 60 mm	M10
E01201			Ø 55 mm	M10
E0120	E4301		Ø 50 mm	M8
E0121	E4302		Ø 40 mm	M8
E0122			Ø 30 mm	M6
E0123			Ø 25 mm	M6
E0124			Ø 20 mm	M6
E0125			Ø 15 mm	M6



Foro/Hole Ø 10,2 mm

AISI 303	AISI 316	Iron	Dimensioni Dimensions
E0126	E4307		Ø 20 mm foro cieco blind hole
E01262			Ø 20 mm foro passante hole
E01292			Ø 25 mm foro cieco blind hole
E01300	E4313		Ø 30 mm foro passante hole



Foro/Hole Ø 12,2 mm

AISI 303	AISI 316	Iron	Dimensioni Dimensions
E01261			Ø 20 mm foro cieco blind hole
E0127	E4308	I0127	Ø 25 mm foro cieco blind hole
E0129	E4311	I0129	Ø 25 mm foro passante hole
E01302		I01302	Ø 30 mm foro cieco blind hole
E0130	E4314	I0130	Ø 30 mm foro passante hole
E0130/SO		I0130/SO	Ø 30 mm foro passante con grano laterale hole with set screw



Foro/Hole Ø 14,2 mm

AISI 303	AISI 316	Iron	Dimensioni Dimensions
E0128	E4309		Ø 25 mm foro cieco blind hole
E01281	E4312		Ø 25 mm foro passante hole
E01301	E4315		Ø 30 mm foro passante hole
E01301/SO			Ø 30 mm foro passante con grano laterale hole with set screw

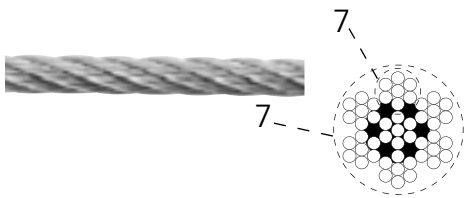

AISI 316	Fune Rope	Forza di rottura minima Min. Brake load
EF7X704	Ø 4 mm	9,00 kN
EF7X705	Ø 5 mm	14,00 kN
EF7X706	Ø 6 mm	20,00 kN



AISI 316	AISI 316	Fune Rope	Y
sinistro/left	destra/right		
ETM04SX	ETM04DX	Ø 4 mm	60 mm
ETM05SX	ETM05DX	Ø 5 mm	60 mm
ETM06SX	ETM06DX	Ø 6 mm	70 mm

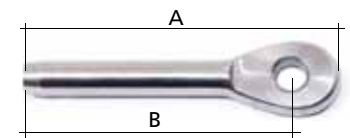

AISI 316	Fune Rope	A	B
ETFF04	Ø 4 mm	55 mm	48 mm
ETFF05	Ø 5 mm	55 mm	48 mm
ETFF06	Ø 6 mm	56,5 mm	48 mm

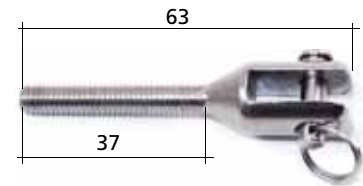

AISI 316	Descrizione Description
ETMT06DX	Filettatura a destra Right hand thread
ETMT06SX	Filettatura a sinistra Left hand thread

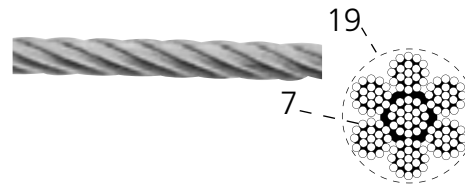
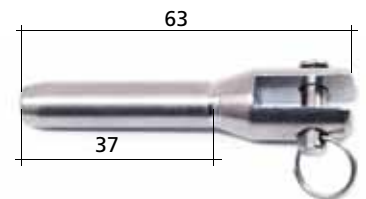

AISI 316	Fune Rope	Forza di rottura minima Min. Brake load
EF7X1904	Ø 4 mm	8,50 kN
EF7X1905	Ø 5 mm	14,00 kN
EF7X1906	Ø 6 mm	20,00 kN



AISI 303	AISI 316	Descrizione Description
ED05	ED05316	Snodo con 2 filetti interni M6 Adjustable ropes with 2 M6 thread

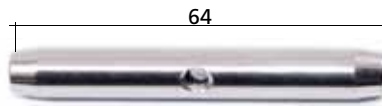

AISI 316	Descrizione Description
ET06	Tenditore con filettature interne sinistra/destra M6 Domed head nut right hand thread M6

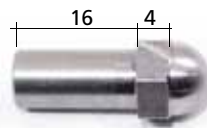

AISI 316	Fune Rope
ETFT04	Ø 4 mm
ETFT05	Ø 5 mm
ETFT06	Ø 6 mm

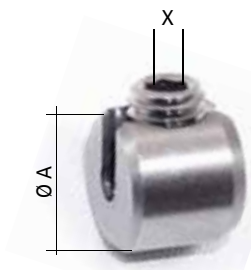
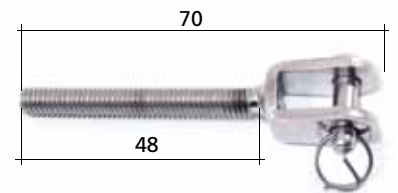

AISI 303	AISI 316	Fune Rope	X	A
EA04	EA04316	Ø 4 mm	M8	Ø 15 mm
EA05	EA05316	Ø 5-6 mm	M6	Ø 20 mm



AISI 316	Descrizione Description
ED06	Dado cieco con gambo prolungato filettatura destra M6 Domed head nut right hand thread M6
ED06SX	Dado cieco con gambo prolungato filettatura sinistra M6 Domed head nut left hand thread M6



AISI 304	Descrizione Description
ETMS06DX	Filettatura a destra Right hand thread
ETMS06SX	Filettatura a sinistra Left hand thread



AISI 303	AISI 316	Per tubo For tube	Foro Hole
EB06	EB06316	Ø 33,7 mm	Ø 6,5 mm
EB061	EB061316	Ø 42,4 mm	Ø 6,5 mm
EB063	EB063316	Superficie piana Flat face	Ø 6,5 mm
EB07	EB07316	Ø 33,7 mm	Ø 8,5 mm
EB071	EB071316	Ø 42,4 mm	Ø 8,5 mm
EB073	EB073316	Superficie piana Flat face	Ø 8,5 mm

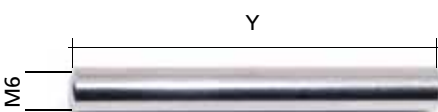

AISI 316	Descrizione Description
ED07	Vite a testa bombata M6 filettatura destra Rounded head screw M6 thread right
ED07SX	Vite a testa bombata M6 filettatura sinistra Rounded head screw M6 thread left

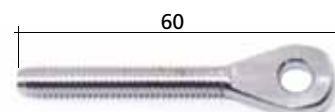

AISI 316	AISI 316	Fune Rope	Y
sinistro/left	destra/right		
ETF04SX	ETF04DX	Ø 4 mm	60 mm
ETF05SX	ETF05DX	Ø 5 mm	60 mm
ETF06SX	ETF06DX	Ø 6 mm	70 mm

AISI 316	Descrizione Description
ETFM06DX	Filettatura a destra Right hand thread
ETFM06SX	Filettatura a sinistra Left hand thread

AISI 304	Fune Rope
ETFS04	Ø 4 mm
ETFS05	Ø 5 mm
ETFS06	Ø 6 mm



AISI 316	Fune Rope	Filetto Thread	A
ETSM8	Ø 4 mm	M6-M8	90 mm
ETSM10	Ø 5 mm	M6-M10	107 mm
ETSM12	Ø 6 mm	M6-M12	119 mm



AISI 303	AISI 316	Fune Rope
ETTB04304	ETTB04	Ø 4 mm
ETTB05304	ETTB05	Ø 5 mm
ETTB06304	ETTB06	Ø 6 mm

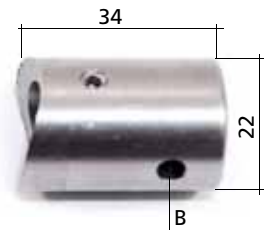

AISI 303	AISI 316	Per tubo For tube	Foro Hole B	Fune Rope
ESF04	ESF04316	Ø 33,7 mm	Ø 4,5 mm	Ø 4 mm
ESF05	ESF05316	Ø 33,7 mm	Ø 5,5 mm	Ø 5 mm
ESF06	ESF06316	Ø 33,7 mm	Ø 6,5 mm	Ø 6 mm
ESF041	ESF041316	Ø 42,4 mm	Ø 4,5 mm	Ø 4 mm
ESF051	ESF051316	Ø 42,4 mm	Ø 5,5 mm	Ø 5 mm
ESF061	ESF061316	Ø 42,4 mm	Ø 6,5 mm	Ø 6 mm
ESF043	ESF043316	Superficie piana Flat face	Ø 4,5 mm	Ø 4 mm
ESF053	ESF053316	Superficie piana Flat face	Ø 5,5 mm	Ø 5 mm
ESF063	ESF063316	Superficie piana Flat face	Ø 6,5 mm	Ø 6 mm



AISI 303	AISI 316	Per tubo For tube	Foro Hole B	Fune Rope
ESF08	ESF08316	Ø 33,7 mm	Ø 8 mm	Ø 4-5-6 mm
ESF081	ESF081316	Ø 42,4 mm	Ø 8 mm	Ø 4-5-6 mm
ESF083	ESF083316	Superficie piana Flat face	Ø 8 mm	Ø 4-5-6 mm

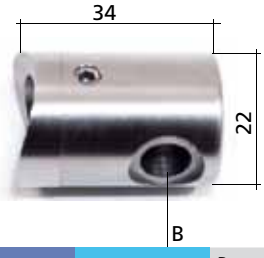

AISI 303	AISI 316	Per tubo For tube	Fune Rope B
EST04DX	EST05DX	Ø 33,7 mm	Ø 4-5-6 mm
EST04SX	EST05SX	Ø 33,7 mm	Ø 4-5-6 mm
EST041DX	EST051DX	Ø 42,4 mm	Ø 4-5-6 mm
EST041SX	EST051SX	Ø 42,4 mm	Ø 4-5-6 mm
EST043DX	EST053DX	Superficie piana Flat face	Ø 4-5-6 mm
EST043SX	EST053SX	Superficie piana Flat face	Ø 4-5-6 mm

ESEMPI DI APPLICAZIONE ACCESSORI PER FUNI- EXAMPLE OF APPLICATION

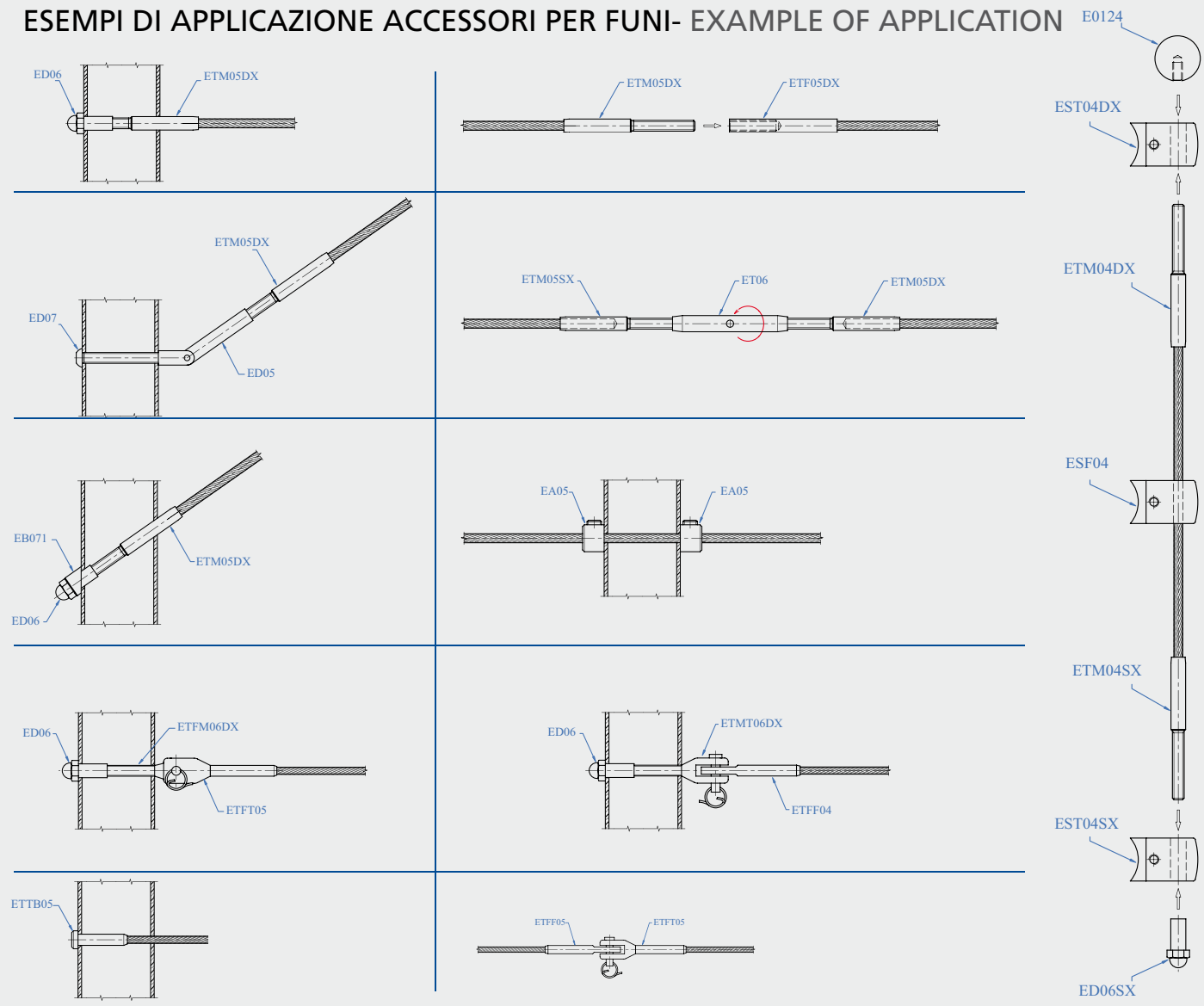

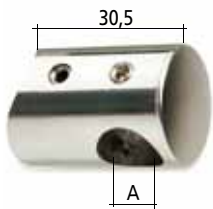

AISI 304	AISI 316	Per tubo For tube	Foro Hole	A
----------	----------	----------------------	--------------	---

X0069	X4042	Ø 42,4 mm Ø 43,0 mm	Ø 12,2 mm passante/through	
X006910	X006910316	Ø 42,4 mm Ø 43,0 mm	Ø 10,2 mm passante/through	



AISI 316	Per tubo For tube
----------	----------------------

X4561	Ø 42,4 x 2,0 mm
X4561/43	Ø 43,0 x 1,5 mm

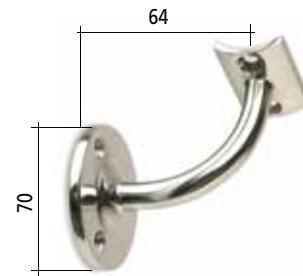

AISI 316	Per tubo For tube
----------	----------------------

X459	Ø 42,4 x 2,0 mm Ø 43,0 x 1,5 mm
------	------------------------------------

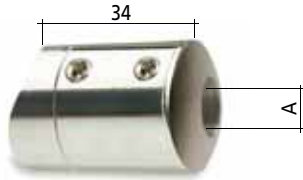

AISI 316	Per tubo For tube	Tondino Round bar	A
----------	----------------------	----------------------	---

X40650	Ø 42,4 mm	Ø 12,2 mm	
--------	-----------	-----------	--



AISI 316	Per tubo For tube
----------	----------------------

X4483	Ø 42,4 x 2,0 mm
-------	-----------------

AISI 316	Altezza Height	Per tubo For tube
----------	-------------------	----------------------

X031/S1316	75 mm	Ø 42,4 x 2,0 mm
X031/S1316/43	75 mm	Ø 43,0 x 1,5 mm



AISI 316	Per tubo For tube	Tondino Round bar	A	a°
----------	----------------------	----------------------	---	----

X0069991316	Ø 42,4 mm	Ø 12,2 mm	22-33	
-------------	-----------	-----------	-------	--



AISI 316	Per tubo For tube	Disco Disc
----------	----------------------	---------------

X113316	Ø 42,4 x 2,0 mm Ø 43,0 x 1,5 mm	Ø 100 x 6 mm
---------	------------------------------------	--------------

AISI 316	Altezza Height	H	Per tubo For tube
----------	-------------------	---	----------------------

X030/S316	75 mm		Ø 42,4 x 2,0 mm
X030/S316/43	75 mm		Ø 43,0 x 1,5 mm



AISI 316	Per tubo For tube
----------	----------------------

X0070316	Ø 42,4 x 2,0 mm
----------	-----------------

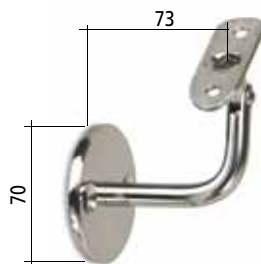

AISI 316	Dimensioni Dimensions	Foro Hole	Altezza Height
----------	--------------------------	--------------	-------------------

X4072	Ø 105 mm	Ø 43 mm	15 mm
X4072/43	Ø 105 mm	Ø 43,5 mm	15 mm
X40731	Ø 105 mm	Ø 51,50 mm	15 mm

AISI 316	Per tubo For tube
----------	----------------------

X02231316	Ø 42,4 x 2,0 mm Ø 43,0 x 1,5 mm
-----------	------------------------------------

AISI 316	Altezza Height	H	Per tubo For tube
----------	-------------------	---	----------------------

X0102316	58 mm		Ø 42,4 x 2,0 mm
X0102316/43	58 mm		Ø 43,0 x 1,5 mm

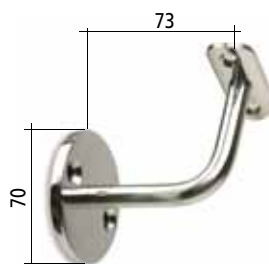

AISI 316	Per tubo For tube
----------	----------------------

X456	Ø 42,4 mm
------	-----------

AISI 316	Per tubo For tube
----------	----------------------

X0223316	Ø 42,4 x 2,0 mm Ø 43,0 x 1,5 mm
----------	------------------------------------

AISI 316	Altezza Height	H	Per tubo For tube
----------	-------------------	---	----------------------

X0102316	58 mm		Ø 42,4 x 2,0 mm
X0102316/43	58 mm		Ø 43,0 x 1,5 mm

TUTTO LUCIDATO A SPECCHIO
ALL MIRROR POLISHED



AISI 316	Altezza Height	H	Per tubo For tube
X458	60 mm		Ø 42,4 x 2,0 mm
X458/43	60 mm		Ø 43,0 x 1,5 mm



AISI 316	Per tubo For tube
X451	Ø 42,4 x 2,0 mm
X451/43	Ø 43,0 x 1,5 mm



AISI 316	C x D	Per tubo For tube	Spessore vetro Glass thick.
X009	43 x 64 mm	Ø 42,4 mm Ø 43,0 mm	8 - 8,76 e/and 10 mm
X00912	38 x 49 mm	Ø 42,4 mm Ø 43,0 mm	8 - 8,76 e/and 10 mm
X00911	38 x 49 mm	Superficie piana Flat face	8 - 8,76 e/and 10 mm
X0091	43 x 64 mm	Superficie piana Flat face	8 - 8,76 e/and 10 mm
X00960	43 x 64 mm	Ø 42,4 mm	10 - 10,76 e/and 12 mm
X00962	43 x 64 mm	Superficie piana Flat face	10 - 10,76 e/and 12 mm



AISI 316	Altezza Height	H	Per tubo For tube
X4581	60 mm		Ø 42,4 x 2,0 mm
X4581/43	60 mm		Ø 43,0 x 1,5 mm



AISI 316	Per tubo For tube
X446	Ø 42,4 x 2,0 mm
X446/43	Ø 43,0 x 1,5 mm

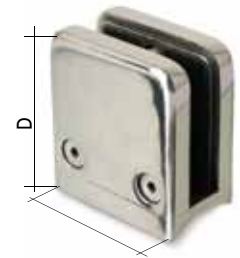

AISI 316	Altezza Height	H	Per tubo For tube
X454	6 mm		Ø 42,4 x 2,0 mm
X454/43	6 mm		Ø 43,0 x 1,5 mm



Glunzione regolabile
Articulated elbow

AISI 316	Per tubo For tube
X4471	Ø 42,4 x 2,0 mm
X4471/43	Ø 43,0 x 1,5 mm

AISI 316	C x D	Per tubo For tube	Spessore vetro Glass thick.
X0092	53 x 53 mm	Ø 42,4 mm Ø 43,0 mm	8 e/and 10 mm
X009221	43 x 43 mm	Ø 42,4 mm	8 e/and 10 mm
X00931	43 x 43 mm	Superficie piana Flat face	8 e/and 10 mm



AISI 316	Per tubo For tube
X468/424	Ø 42,4 x 2,0 mm
X468/43	Ø 43,0 x 1,5 mm



AISI 316	C x D	Per tubo For tube	Spessore vetro Glass thick.
X00950	52 x 64 mm	Ø 42,4 mm sx Ø 43,0 mm sx	8 - 8,76 e/and 10 mm

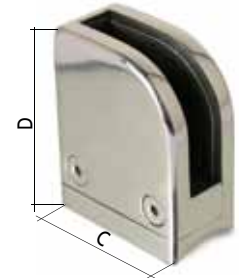

AISI 316	Per tubo For tube
X443	Ø 42,4 x 2,0 mm
X443/43	Ø 43,0 x 1,5 mm



AISI 316	C x D	Per tubo For tube	Spessore vetro Glass thick.
X00955	52 x 64 mm	Ø 42,4 mm dx Ø 43,0 mm dx	8 - 8,76 e/and 10 mm

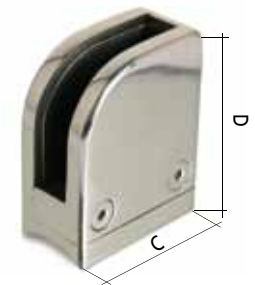

AISI 316	Per tubo For tube
X450	Ø 42,4 x 2,0 mm
X450/43	Ø 43,0 x 1,5 mm

AISI 316	Per tubo For tube
X455	Ø 42,4 x 2,0 mm
X455/43	Ø 43,0 x 1,5 mm



AISI 316	Per tubo For tube
X465	Ø 42,4 x 2,0 mm
X465/43	Ø 43,0 x 1,5 mm



AISI 316	Per tubo For tube
X01151316	Ø 42,4 x 2,0 mm
X01151316/43	Ø 43,0 x 1,5 mm



AISI 316	Dimensioni Dimensions	Foro Hole
X4308	Ø 25 mm foro cieco - blind hole	Ø 12,2 mm
X4309	Ø 25 mm foro cieco - blind hole	Ø 14,2 mm
X4311	Ø 25 mm foro passante - hole	Ø 12,2 mm
X4312	Ø 25 mm foro passante - hole	Ø 14,2 mm



AISI 316	Per tubo For tube
X011316	Ø 42,4 x 2,0 mm
X011316/43	Ø 43,0 x 1,5 mm



AISI 316	Per tubo For tube
X0119316	Ø 42,4 x 2,0 mm
X0119316/43	Ø 43,0 x 1,5 mm



AISI 316	Per tubo For tube
X452	Ø 42,4 x 2,0 mm



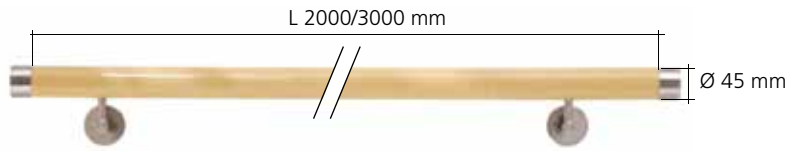

Colore/Colour: Naturale/Natural

AISI 304	Composto da: Composed of:	Lunghezza Length
E6951/1	E691 + n° 2 E4265 + n° 2 E4586	2000 mm
E6951/2	E691 + n° 2 E4260 + n° 2 E4586	2000 mm
E6951/3	E691 + n° 2 E4265 + n° 2 E0224	2000 mm
E6951/4	E691 + n° 2 E4260 + n° 2 E0224	2000 mm
E6951/5	E691 + E4265 + E4260 + E4586 + E0224	2000 mm

AISI 304	Composto da: Composed of:	Lunghezza Length in inches
E6961/1	E691/3000 + n° 2 E4265 + n° 3 E4586	3000 mm
E6961/2	E691/3000 + n° 2 E4260 + n° 3 E4586	3000 mm
E6961/3	E691/3000 + n° 2 E4265 + n° 3 E0224	3000 mm
E6961/4	E691/3000 + n° 2 E4260 + n° 3 E0224	3000 mm

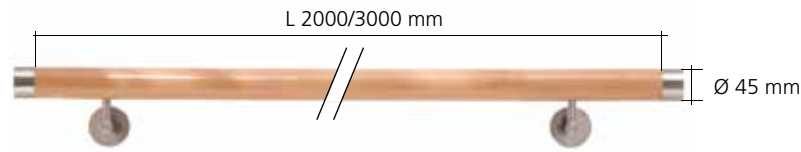

Colore/Colour: Faggio/Beech

AISI 304	Composto da: Composed of:	Lunghezza Length
E695/1	E690 + n° 2 E4265 + n° 2 E4586	2000 mm
E695/2	E690 + n° 2 E4260 + n° 2 E4586	2000 mm
E695/3	E690 + n° 2 E4265 + n° 2 E0224	2000 mm
E695/4	E690 + n° 2 E4260 + n° 2 E0224	2000 mm
E695/5	E690 + E4265 + E4260 + E4586 + E0224	2000 mm

AISI 304	Composto da: Composed of:	Lunghezza Length
E696/1	E690/3000 + n° 2 E4265 + n° 3 E4586	3000 mm
E696/2	E690/3000 + n° 2 E4260 + n° 3 E4586	3000 mm
E696/3	E690/3000 + n° 2 E4265 + n° 3 E0224	3000 mm
E696/4	E690/3000 + n° 2 E4260 + n° 3 E0224	3000 mm

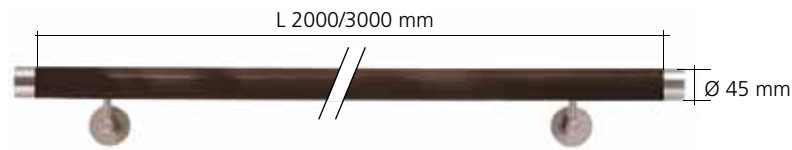

Colore/Colour: Wengè

AISI 304	Composto da: Composed of:	Lunghezza Length
E6952/1	E692 + n° 2 E4265 + n° 2 E4586	2000 mm
E6952/2	E692 + n° 2 E4260 + n° 2 E4586	2000 mm
E6952/3	E692 + n° 2 E4265 + n° 2 E0224	2000 mm
E6952/4	E692 + n° 2 E4260 + n° 2 E0224	2000 mm
E6952/5	E692 + E4265 + E4260 + E4586 + E0224	2000 mm

AISI 304	Composto da: Composed of:	Lunghezza Length
E6962/1	E692/3000 + n° 2 E4265 + n° 3 E4586	3000 mm
E6962/2	E692/3000 + n° 2 E4260 + n° 3 E4586	3000 mm
E6962/3	E692/3000 + n° 2 E4265 + n° 3 E0224	3000 mm
E6962/4	E692/3000 + n° 2 E4260 + n° 3 E0224	3000 mm



Grezzo da verniciare - Raw finish, unpainted

Wood	Descrizione Description
E690/G	Corrimano in legno lg. 2,0 m Wooden handrail 6,5 ft long
E690/3000/G	Corrimano in legno lg. 3,0 m Wooden handrail 10 ft long



Colore/Colour: Naturale/Natural

Wood	Descrizione Description
E691	Corrimano in legno lg. 2,0 m Wooden handrail 6,5 ft long
E691/3000	Corrimano in legno lg. 3,0 m Wooden handrail 10 ft long



Colore/Colour: Faggio/Beech

Wood	Descrizione Description
E690	Corrimano in legno lg. 2,0 m Wooden handrail 6,5 ft long
E690/3000	Corrimano in legno lg. 3,0 m Wooden handrail 10 ft long



Colore/Colour: Wengè

Wood	Descrizione Description
E692	Corrimano in legno lg. 2,0 m Wooden handrail 6,5 ft long
E692/3000	Corrimano in legno lg. 3,0 m Wooden handrail 10 ft long



AISI 304 Descrizione
Description

E602 Raccordo a "T" per tubo
"T" fitting for tube Ø 42,4 x 2,0 mm



AISI 304 Descrizione
Description

E605 Giunzione snodata
Pivotable connector



AISI 304 Descrizione
Description

E0224 Reggicorrimano
Handrail support



AISI 304 Descrizione
Description

E603 Giunzione per corrimani in legno
Wooden handrail connector Ø 45 mm



AISI 304 Descrizione
Description

E6070 Giunzione snodata
Pivotable connector

Plastic Descrizione
Description

E600/T Tappi di plastica completi di vite per fissaggio dei terminali e delle curve
Plastic supports for end caps and fittings (screw included)



Aluminium Descrizione
Description

E600/D Dima di centraggio per forature dei corrimani
Drill-gauge for wooden handrails



AISI 304 Descrizione
Description

E6080 Diametro foro
Hole Diameter
Ø 45 mm

AISI 304 Descrizione
Description

E600 Curva corrimano 90°
90° curved



AISI 304 Descrizione
Description

E4265 Terminale piano
Flat end terminal



AISI 304 Descrizione
Description

E4260 Terminale bombato
Rounded end terminal

Iron Descrizione
Description

E600/D1 Dima per eseguire fori radiali per corrimani Ø 45 mm
Drilling template for radial holes in wooden handrails Ø 45 mm

AISI 304 Descrizione
Description

E601 Angolo corrimano 90°
90° angle

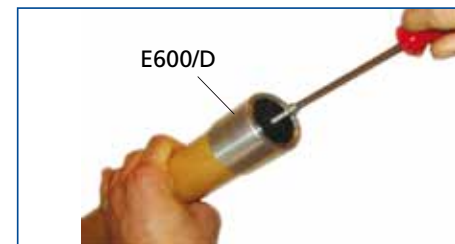

AISI 304 Descrizione
Description

E604 Curva regolabile
Articulated angle

AISI 304 Descrizione
Description

E4586 Reggicorrimano
Handrail support

EINSM6X12
ESM614 Dado da infilare + vite filettata M6 compresi nella fornitura del reggicorrimano E4586
Screw in nut + set screw M6 included with handrail support E4586



RIVOLUZIONARIO SISTEMA DI RECINZIONI TRASPARENTI

TESTATO E CERTIFICATO A 200 Kg/ml

LA CERTIFICAZIONE E IL RAPPORTO DEI TEST
SONO DISPONIBILI SUL SITO

WWW.ARTEFERROINOX.COM

REVOLUTIONARY SYSTEM FOR GLASS RAILING

TESTED AND CERTIFIED AT 200 Kg/ml

CERTIFICATION AND TESTED
REPORT AVAILABLE AT

WWW.ARTEFERROINOX.COM

Supporto per vetro a pavimento - Floor Fixing Channel End Accessories

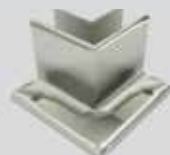
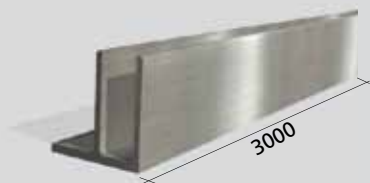

ALUMINIUM Descrizione Description

E1600100 Supporto per vetro da ancorare a pavimento in alluminio effetto acciaio inox
Aluminium support for floor anchorage

ALUMINIUM Cod. art. Art. no.

E1600500

ALUMINIUM Cod. art. Art. no.

E1600600

ALUMINIUM Cod. art. Art. no.

E1600700



Supporto per vetro a parete - Wall Fixing Channel End Accessories

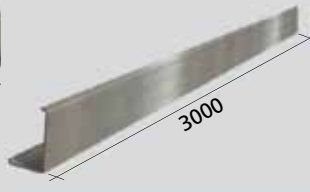

ALUMINIUM Descrizione Description

E1700200 Supporto per vetro da ancorare a parete in alluminio effetto acciaio inox
Aluminium support for wall anchorage

ALUMINIUM Descrizione Description

E1700300 Carter di chiusura fori per E1700200
Carter to cover the holes of E1700200

ALUMINIUM Cod. art. Art. no.

E1700500

ALUMINIUM Cod. art. Art. no.

E1700600

ALUMINIUM Cod. art. Art. no.

E1700700

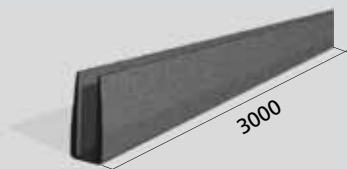
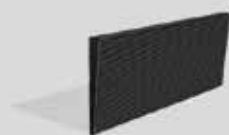
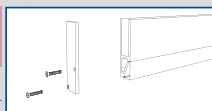

Rubber Descrizione Description

E1999830 Cuneo di fissaggio in materiale sintetico
Fixing wedge made of synthetic material

Rubber Descrizione Description

E1999800 Guarnizioni per art. E1600100 e E1700200
Gaskets for art. E1600100 and E1700200

E1999810 Guarnizioni per art. E1600100 e E1700200
Gaskets for art. E1600100 and E1700200

Spessore vetro Glass thickness

16,76
17,52 mm

20,76
21,52 mm

Rubber Descrizione Description

E1999850 Guarnizioni di chiusura
Closing Gaskets

E1999860 Guarnizioni di chiusura
Closing Gaskets

Spessore vetro Glass thickness

16,76
17,52 mm

20,76
21,52 mm

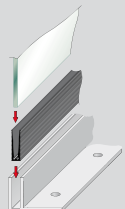

INSERIRE VETRO NEL DISPOSITIVO DI SERRAGGIO E ADAGIARE IL TUTTO NEL PROFILO IN ALLUMINIO
INSERT THE GLASS IN THE CLOSING DEVICE AND LAY EVERYTHING IN THE ALUMINIUM PROFILE

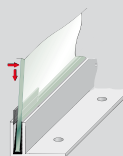

SBILANCIARE IL VETRO SU UN LATO ED INSERIRE I CUNEI NELLA PARTE OPPOSTA DEL VETRO.
MOVE THE GLASS ON ONE SIDE AND INSERT WEDGES IN THE OPPOSITE SIDE OF THE GLASS

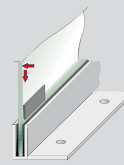

FISSARE DEFINITIVAMENTE IL VETRO INSERENDO I CUNEI NEL LATO IN CUI MANCANO ESERCITANDO UNA LEGGERA PRESSIONE
FIX THE GLASS PUTTING WEDGES IN THE OTHER SIDE OF THE GLASS APPLYING A SLIGHT PRESSION

PER LUOGHI PUBBLICI
E AFFOLLATI

TESTATO A 300 KG/ML

UNA COPIA COMPLETA DEI TEST TÜV
SONO DISPONIBILI SUL SITO
WWW.ARTEFERROINOX.COM

FOR PUBLIC AND
CROWDED SPACES

TESTED AT 300 Kg/ml

FULL COPY THE TÜV TEST REPORT IS
AVAILABLE DOWNLOAD AT
WWW.ARTEFERROINOX.COM

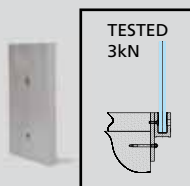

TESTED
3kN

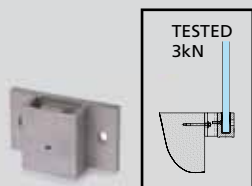

TESTED
3kN

Iron

Cod. art.
Art. no.

E1800200

Iron

Cod. art.
Art. no.

E1800300

ALUMINIUM

Cod. art.
Art. no.

E1800800

Aluminium

Descrizione
Description

Supporto per vetro da ancorare
a pavimento in alluminio effetto
acciaio inox
Aluminium support for floor
anchorage

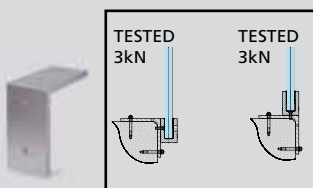

TESTED
3kN

TESTED
3kN

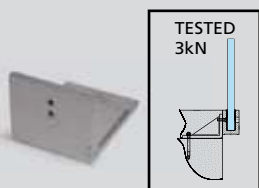

TESTED
3kN

Iron

Cod. art.
Art. no.

E1800400

Iron

Cod. art.
Art. no.

E1800500

Rubber

Cod. art.
Art. no.

E1800600

Descrizione
Description

Guarnizioni in gomma da utilizzare con
articoli E1800100
Rubber gaskets to be used with items E1800100

Spessore vetro
Glass thickness

26,5 - 27 mm
1 3/64" - and 1 1/16"

E1800700

Guarnizioni in gomma da utilizzare con
articoli E1800100
Rubber gaskets to be used with items E1800100

30,5 - 31 mm
1 13/64" and 1 7/32"

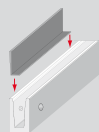
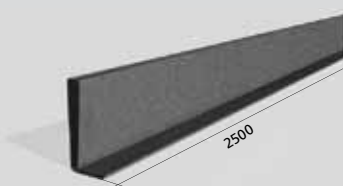

INSERIRE ALL'INTERNO DEL PROFILO
IN ALLUMINIO LA GUARNIZIONE AD L
INSERT IN THE ALUMINIUM PROFILE THE
CHOSEN L SHAPED RUBBER GASKET

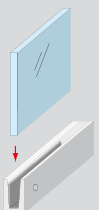

ADAGIARE IL VETRO
AL PROFILO AD L
PUT THE GLASS INSIDE THE
RUBBER GASKET

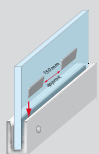

FISSARE IL TUTTO UTILIZZANDO
I CUNEI DENTATI POSIZIONARE I CUNEI NEL LATO
OPPOSTO ALLA GUARNIZIONE AD L
FIX THE WHOLE STRUCTURE USING THE
WEDGES. PLACE THE WEDGES ON THE
OPPOSITE SIDE OF THE L SHAPED GASKET

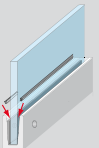

TERMINARE IL MONTAGGIO APPLICANDO
LE GUARNIZIONI DI CHIUSURA PER
PROTEGGERE IL SISTEMA DAGLI
AGENTI ATMOSFERICI
FINISH THE ASSEMBLY BY PUTTING THE
CLOSING GASKET TO PROTECT THE SYSTEM AGAINST THE
WEATHER (RAIN, SNOW, ETC.)

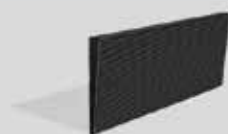

Rubber

Cod. art.
Art. no.

E1800610

Descrizione
Description

Cuneo di fissaggio in materiale sintetico
Fixing wedge made of synthetic material

Spessore vetro
Glass thickness

26,5 - 27 mm
1 3/64" - and 1 1/16"

E1800710

Cuneo di fissaggio in materiale sintetico
Fixing wedge made of synthetic material

30,5 - 31 mm
1 13/64" and 1 7/32"



Rubber

Cod. art.
Art. no.

E1800620

Descrizione
Description

Guarnizioni di chiusura
Closing Gaskets

Spessore vetro
Glass thickness

26,5 - 27 mm
5/8" - and 11/16"

Lunghezza bobina
Coil length

30 mt.
100'

E1800720

Guarnizioni di chiusura
Closing Gaskets

26,5 - 27 mm
5/8" - and 11/16"

30 mt.
100'





Grezzo da verniciare - Raw finish, unpainted

Wood	Descrizione Description
EW110000G	Corrimano in legno lg. 2,0 m Wooden handrail 6,5 ft long



Grezzo da verniciare - Raw finish, unpainted

Wood	Descrizione Description
EW1100424G	Corrimano in legno lg. 2,0 m Wooden handrail 6,5 ft long



AISI 316	Tubo scanalato Groove tube
EW120010	Ø 42,4 mm



Colore/Colour: Naturale/Natural

Wood	Descrizione Description
EW1100001	Corrimano in legno lg. 2,0 m Wooden handrail 6,5 ft long



Colore/Colour: Naturale/Natural

Wood	Descrizione Description
EW11004241	Corrimano in legno lg. 2,0 m Wooden handrail 6,5 ft long



AISI 316	Tubo Tube
E1500100	Ø 42,4 x 1,5 mm
E1500110	Ø 48,3 x 1,5 mm



Colore/Colour: Faggio/Beech

Wood	Descrizione Description
EW1100002	Corrimano in legno lg. 2,0 m Wooden handrail 6,5 ft long



Colore/Colour: Faggio/Beech

Wood	Descrizione Description
EW11004242	Corrimano in legno lg. 2,0 m Wooden handrail 6,5 ft long



AISI 316	Tubo Tube
E1400100	Ø 42,4 x 1,5 mm
E1400110	Ø 48,3 x 1,5 mm



Colore/Colour: Wengè

Wood	Descrizione Description
EW1100003	Corrimano in legno lg. 2,0 m Wooden handrail 6,5 ft long



Colore/Colour: Wengè

Wood	Descrizione Description
EW11004243	Corrimano in legno lg. 2,0 m Wooden handrail 6,5 ft long



AISI 316	Tubo Tube
E1300100	Ø 42,4 x 1,5 mm
E1300110	Ø 48,3 x 1,5 mm



Disponibile anche in multipli di 6 metri
Also available in groups of 6 meters

Rubber	Tubo Tube	Vetro Glass	Lungh. bobina Coil length
E1999100	Ø 42,4 mm	8 - 10,76 mm	30 mt.
E1999200	Ø 42,4 mm	12 - 16,76 mm	30 mt.
E1999300	Ø 42,4 mm	16,76 - 18 mm	30 mt.
E1999400	Ø 48,3 mm	8 - 13 mm	30 mt.
E1999500	Ø 48,3 mm	14 - 18 mm	30 mt.
E1999650	Ø 48,3 mm	18 - 21,5 mm	30 mt.



AISI 316	Tubo Tube
E1100424	Ø 42,4 x 15 x 6000 mm
E1100483	Ø 48,3 x 1,5 x 6000 mm



AISI 316	Tubo Tube
E1200100	Ø 42,4 x 1,5 mm
E1200110	Ø 48,3 x 1,5 mm



AISI 316	Tubo Tube
E1100000	Ø 42,4 x 15 x 6000 mm



AISI 316	Tubo Tube
E1100100	Ø 42,4 x 1,5 mm
E1100110	Ø 48,3 x 1,5 mm



AISI 304	Lungh. Length 3000 mm	AISI 304	Lungh. Length 3000 mm
E00152020	20 x 20 x 1,5 mm	E06152020	20 x 20 x 1,5 mm
E00202525	25 x 25 x 2,0 mm	E06202525	25 x 25 x 2,0 mm
E00203030	30 x 30 x 2,0 mm	E06203030	30 x 30 x 2,0 mm
E00204040	40 x 40 x 2,0 mm	E06204040	40 x 40 x 2,0 mm
E00205050	50 x 50 x 2,0 mm	E06205050	50 x 50 x 2,0 mm
E00206060	60 x 60 x 2,0 mm	E06206060	60 x 60 x 2,0 mm

AISI 316	Lungh. Length 3000 mm	AISI 316	Lungh. Length 3000 mm
E10152020	20 x 20 x 1,5 mm	E16152020	20 x 20 x 1,5 mm
E10202525	25 x 25 x 2,0 mm	E16202525	25 x 25 x 2,0 mm
E10203030	30 x 30 x 2,0 mm	E16203030	30 x 30 x 2,0 mm
E10204040	40 x 40 x 2,0 mm	E16204040	40 x 40 x 2,0 mm
E10205050	50 x 50 x 2,0 mm	E16205050	50 x 50 x 2,0 mm
E10206060	60 x 60 x 2,0 mm	E16206060	60 x 60 x 2,0 mm
E10203020	30 x 20 x 2,0 mm	E16203020	30 x 20 x 2,0 mm
E10204020	40 x 20 x 2,0 mm	E16204020	40 x 20 x 2,0 mm
E10204030	40 x 30 x 2,0 mm	E16204030	40 x 30 x 2,0 mm
E10205030	50 x 30 x 2,0 mm	E16205030	50 x 30 x 2,0 mm
E10206040	60 x 40 x 2,0 mm	E16206040	60 x 40 x 2,0 mm

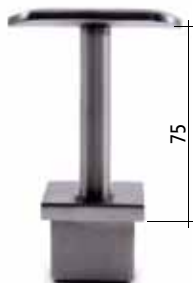

AISI 303	AISI 316	Per tubo quadro For square tube
E037500	E037510	30 x 30 x 2,0 mm
E037600	E037610	40 x 40 x 2,0 mm



AISI 303	AISI 316	Per tubo quadro For square tube
E037100	E037110	30 x 30 x 2,0 mm
E037200	E037210	40 x 40 x 2,0 mm

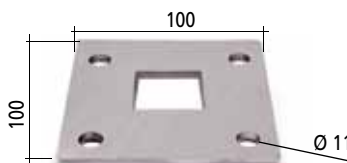

AISI 304	AISI 316	Per tubo For tube	Spess. Thickn.
E02050	E02050316	40 x 40 mm	6 mm



AISI 316	Per tubo For tube	B
E4700	30 x 30 x 2,0 mm	70 mm
E4701	40 x 40 x 2,0 mm	80 mm
E4702	50 x 50 x 2,0 mm	95 mm
E4703	60 x 60 x 2,0 mm	105 mm



Richiedeteci il nostro catalogo completo

Ask for our complete catalogue

www.arteferro.com



AISI 304	AISI 316	Foro Hole	Altezza Height
E02051	E02051316	41 x 41 mm	15 mm



AISI 316	Foro Hole	Altezza Height
E02052316	41 x 41 mm	15 mm



AISI 304	AISI 316	Per tubo For tube	A
E11340	E11340316	Superficie piana Flat face	

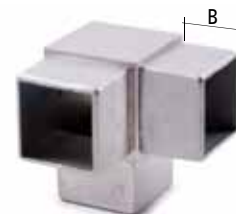

AISI 316	Per tubo For tube	B
E4720	20 x 20 x 1,5 mm	20 mm
E4721	25 x 25 x 2,0 mm	20 mm
E4722	30 x 30 x 2,0 mm	25 mm
E4723	40 x 40 x 2,0 mm	25 mm

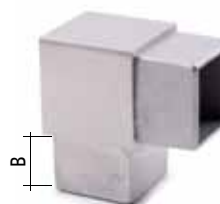

AISI 316	Per tubo For tube	B
E4710	20 x 20 x 1,5 mm	20 mm
E4711	25 x 25 x 2,0 mm	20 mm
E4712	30 x 30 x 2,0 mm	25 mm
E4713	40 x 40 x 2,0 mm	25 mm

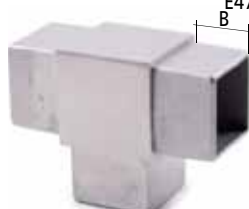

AISI 316	Per tubo For tube
E4743	40 x 40 x 2,0 mm

AISI 316	Per tubo For tube	B
E4730	20 x 20 x 1,5 mm	20 mm
E4731	25 x 25 x 2,0 mm	20 mm
E4732	30 x 30 x 2,0 mm	25 mm
E4733	40 x 40 x 2,0 mm	25 mm

AISI 316	Per tubo For tube
E4200	20 x 20 x 1,5 mm
E4210	25 x 25 x 2,0 mm
E4220	30 x 30 x 2,0 mm
E4230	40 x 40 x 2,0 mm
E4240	50 x 50 x 2,0 mm
E4250	60 x 60 x 2,0 mm

AISI 316	Per tubo For tube
E4251	30 x 20 x 2,0 mm
E4252	40 x 20 x 2,0 mm
E4253	40 x 30 x 2,0 mm
E4254	50 x 30 x 2,0 mm
E4255	60 x 60 x 2,0 mm

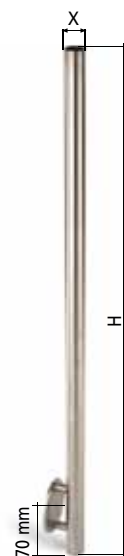
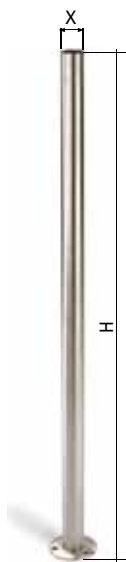

AISI 316	AISI 304	Iron	X	H
E00421316	E00421	I00421	33,7 x 2,0 mm	1000 mm
E00422316	E00422	I00422	33,7 x 2,0 mm	1200 mm
E0042316	E0042	I0042	42,4 x 2,0 mm	1000 mm
E0040316	E0040	I0040	42,4 x 2,0 mm	1200 mm

AISI 316	AISI 304	Iron	X	H
E004501316	E004501	I00451	33,7 x 2,0 mm	1200 mm
E00450316	E00450	I00450	42,4 x 2,0 mm	1200 mm

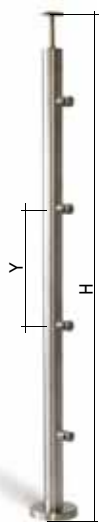

AISI 304	AISI 316	Ø montante Newel post dia.	Ø tondini bar diameter	N° reggitondini N° bar holder	Y	Reggicorrimano snodato Pivotable handrail support	H
EM2331205F	EM4331205F	33,7 x 2,0 mm	12 mm	5	170 mm	No	1000 mm
EM2331207F	EM4331207F	33,7 x 2,0 mm	12 mm	7	125 mm	No	1000 mm
EM2421205F	EM4421205F	42,4 x 2,0 mm	12 mm	5	170 mm	No	1000 mm
EM2421207F	EM4421207F	42,4 x 2,0 mm	12 mm	7	125 mm	No	1000 mm
EM2331205S	EM4331205S	33,7 x 2,0 mm	12 mm	5	170 mm	Si - Yes	1000 mm
EM2331207S	EM4331207S	33,7 x 2,0 mm	12 mm	7	125 mm	Si - Yes	1000 mm
EM2421205S	EM4421205S	42,4 x 2,0 mm	12 mm	5	170 mm	Si - Yes	1000 mm
EM2421207S	EM4421207S	42,4 x 2,0 mm	12 mm	7	125 mm	Si - Yes	1000 mm

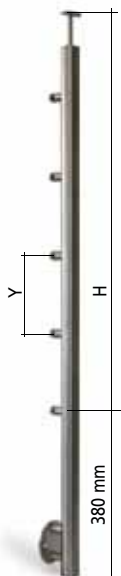

AISI 304	AISI 316	Ø montante Newel post dia.	Ø tondini bar diameter	N° reggitondini N° bar holder	Y	Reggicorrimano snodato Pivotable handrail support	H
EL2331205F	EL4331205F	33,7 x 2,0 mm	12 mm	5	170 mm	No	1200 mm
EL2331207F	EL4331207F	33,7 x 2,0 mm	12 mm	7	125 mm	No	1200 mm
EL2421205F	EL4421205F	42,4 x 2,0 mm	12 mm	5	170 mm	No	1200 mm
EL2421207F	EL4421207F	42,4 x 2,0 mm	12 mm	7	125 mm	No	1200 mm
EL2331205S	EL4331205S	33,7 x 2,0 mm	12 mm	5	170 mm	Si - Yes	1200 mm
EL2331207S	EL4331207S	33,7 x 2,0 mm	12 mm	7	125 mm	Si - Yes	1200 mm
EL2421205S	EL4421205S	42,4 x 2,0 mm	12 mm	5	170 mm	Si - Yes	1200 mm
EL2421207S	EL4421207S	42,4 x 2,0 mm	12 mm	7	125 mm	Si - Yes	1200 mm

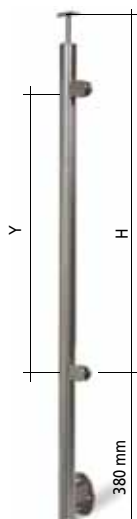
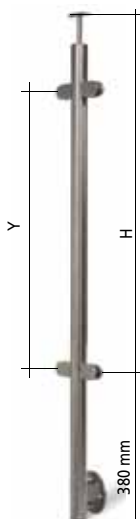

R = Reggicorrimano snodato - Pivotal handrail support

R = Reggicorrimano snodato - Pivotal handrail support

AISI 304	AISI 316	Ø montante Newel post dia.	Y	H	R
ER23304PF	ER43304PF	33,7 x 2,0 mm	640 mm	1200 mm	No
ER23304PS	ER43304PS	33,7 x 2,0 mm	640 mm	1200 mm	Si - Yes
ER24204PF	ER44204PF	42,4 x 2,0 mm	640 mm	1200 mm	No
ER24204PS	ER44204PS	42,4 x 2,0 mm	640 mm	1200 mm	Si - Yes

AISI 304	AISI 316	Ø montante Newel post dia.	Y	H	R
ER23302PF	ER43302PF	33,7 x 2,0 mm	640 mm	1200 mm	No
ER23302PS	ER43302PS	33,7 x 2,0 mm	640 mm	1200 mm	Si - Yes
ER24202PF	ER44202PF	42,4 x 2,0 mm	640 mm	1200 mm	No
ER24202PS	ER44202PS	42,4 x 2,0 mm	640 mm	1200 mm	Si - Yes

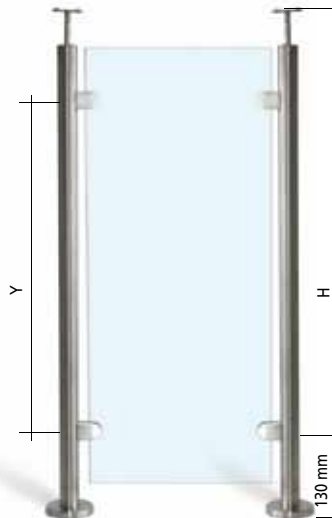
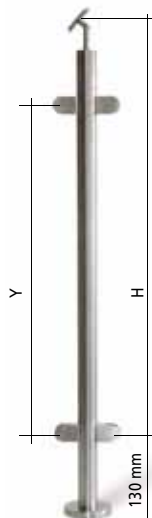

R = Reggicorrimano snodato - Pivotal handrail support

R = Reggicorrimano snodato - Pivotal handrail support

AISI 304	AISI 316	Ø montante Newel post dia.	Y	H	R
EP23304PF	EP43304PF	33,7 x 2,0 mm	640 mm	1000 mm	No
EP23304PS	EP43304PS	33,7 x 2,0 mm	640 mm	1000 mm	Si - Yes
EP24204PF	EP44204PF	42,4 x 2,0 mm	640 mm	1000 mm	No
EP24204PS	EP44204PS	42,4 x 2,0 mm	640 mm	1000 mm	Si - Yes

AISI 304	AISI 316	Ø montante Newel post dia.	Y	H	R
EP23302PF	EP43302PF	33,7 x 2,0 mm	640 mm	1000 mm	No
EP23302PS	EP43302PS	33,7 x 2,0 mm	640 mm	1000 mm	Si - Yes
EP24202PF	EP44202PF	42,4 x 2,0 mm	640 mm	1000 mm	No
EP24202PS	EP44202PS	42,4 x 2,0 mm	640 mm	1000 mm	Si - Yes

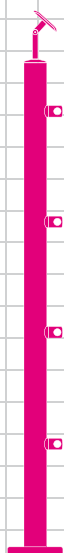

Se quello che cerchi non è qui noi possiamo farlo apposta per te!

If you can't find what you need, we can make it specially for you!

MONTANTI EXTRA STRONG 3kN EXTRA STRONG NEWEL POSTS 3kN

Nasce la linea di montanti extra strong !!

4 nuovi modelli testati e certificati secondo le più severe norme di sicurezza. Ogni piantone resiste ad una trazione orizzontale di 1.5 Kn. Montandone 2 ad una distanza di 1 mt otterremo un parapetto capace di resistere a 3 Kn di trazione. Testato dall'ente internazionale TÜV SÜD. Test report numero MEC 10117.00

A new line of extra strong newel posts is now available !!

4 new tested models, certified according to the most severe security laws. Each post resists to an horizontal traction force of 1.5 kN. With 2 of them placed 1m away one another we would get a railing (baluster) resisting to a 3kN traction force Tested by the international company TÜV SÜD. Test report number MEC 10117.00

EXTRA STRONG 

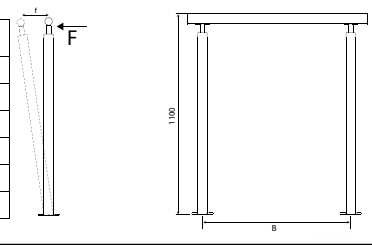

F	B (max)	f
0,50 Kn/m	1500 mm	≤ 25 mm
0,75 Kn/m	1500 mm	≤ 25 mm
1,00 Kn/m	1000 mm	≤ 25 mm
1,50 Kn/m	1000 mm	≤ 25 mm
2,00 Kn/m	1000 mm	≤ 25 mm
3,00 Kn/m	1000 mm	≤ 25 mm

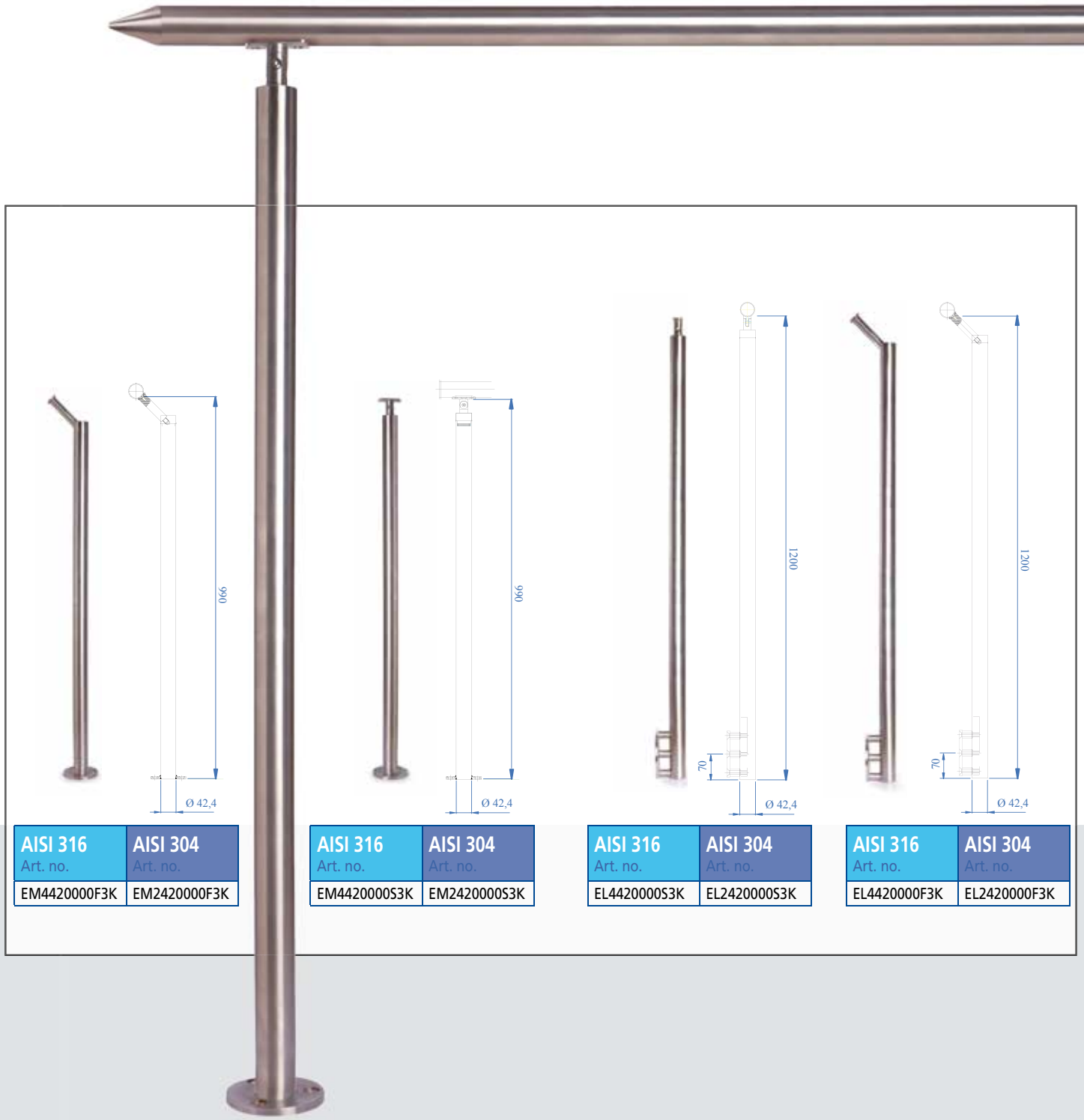

UNA COPIA COMPLETA DEI TEST TÜV SONO
DISPONIBILI SU
WWW.ARTEFERRO.COM

A FULL COPY OF THE TÜV TEST REPORT
IS AVAILABLE DOWNLOAD AT
WWW.ARTEFERRO.COM

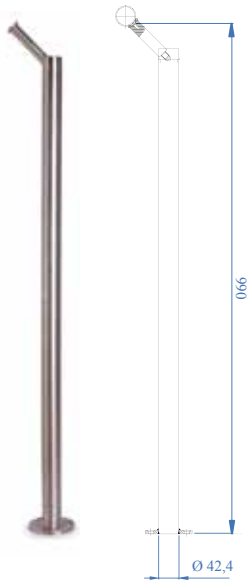
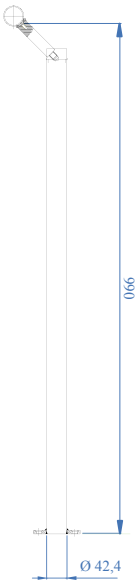
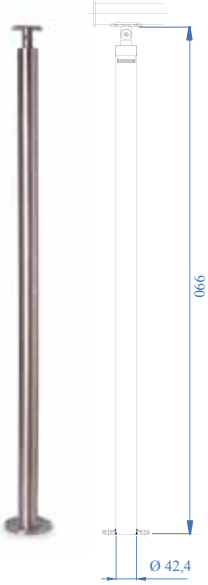

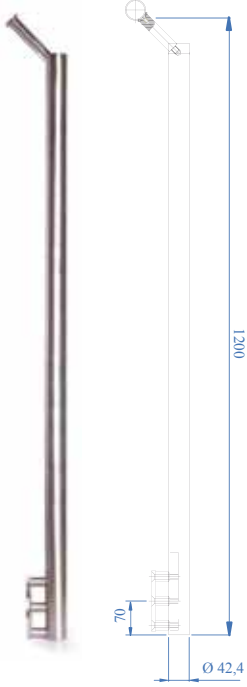
					
AISI 316 Art. no. EM4420000F3K	AISI 304 Art. no. EM2420000F3K	AISI 316 Art. no. EM4420000S3K	AISI 304 Art. no. EM2420000S3K	AISI 316 Art. no. EL4420000S3K	AISI 304 Art. no. EL2420000S3K
AISI 316 Art. no. EL4420000F3K	AISI 304 Art. no. EL2420000F3K				

I MONTANTI EXTRA STRONG CERTIFICATI
CERTIFIED EXTRA STRONG NEWEL POSTS

REGGICORRIMANO
TONDO PIENO DIAMETRO
14 mm
SOLID ROUND
DIA. 14 mm
HANDRAIL SUPPORT

REGGICORRIMANO
DISASSATO
ANTISCALATA
ANTI-Climbing
MISALIGNED
HANDRAIL SUPPORT

SALDATO E SUCCESSIVAMENTE
MOLATO
WELDED AND
THEN GRINDED

SPESSORE TUBO
3 mm
TUBE THICKNESS
3 mm

4 FORI PER UNA
MAGGIORE TENUTA
4 HOLES FOR A
STRONGER HOLD

DOPPIA SALDATURA A
TIG CONTINUA SOPRA E
SOTTO
DOUBLE TIG CONTINUOUS
UP AND UNDER WELDING

SPESSORE FLANGIA
8 mm
FLANGE THICKNESS
8 mm



enjoy the

new

website

www.arteferroinox.com



IL GRANDE FABBRO

ARCHITECTURAL METAL CONTRACTING

Vicenza Fiera - Tradeshow



Asiago Chalet privato - Private chalet



Kuwait Villa privata - Private Villa



Bassano del Grappa Residence



Megeve Villa privata - Private Villa



Okija Tenuta provata - Manor House



Thiene Villa privata - Private Villa



Principato di Monaco Palazzo - Palace



IL GRANDE FABBRO® è la divisione di Ind.i.a. SPA che si occupa di lavori finiti.

In gran parte dei casi questo accade collaborando con i fabbri che tramite Ind.i.a. ci contattano (un esempio è stato il restauro di Piazza Vittorio a Roma). Qualche volta direttamente (creazione ex novo del ferro battuto ad Euro Disney, Parigi) causa enormità dell'opera che ci obbliga ad affrontare il lavoro in prima persona.

IL GRANDE FABBRO® è infatti sempre a disposizione del progettista laddove i lavori di recinzione, protezione o puramente estetici in ferro, inox e altri metalli siano parte importante di un progetto. Uno studio tecnico in grado di progettare con esperienza e creatività qualsiasi elemento il committente richieda ed una squadra di dipendenti altamente qualificati con capacità tali da permetterci di sviluppare opere di qualunque dimensione e complessità sono gli elementi chiave che ci contraddistinguono. La presenza capillare nei mercati principali della casa madre Ind.i.a. SPA (20 filiali ed oltre 2500 distributori), leader mondiale nella produzione e distribuzione di semi lavorati in ferro ed acciaio inox, facilita ad IL GRANDE FABBRO® l'esecuzione di opere praticamente in ogni parte del mondo. In conclusione; capacità tecniche, conoscenze artistiche e la flessibilità offerte da IL GRANDE FABBRO® lo rendono il partner ideale per chiunque abbia necessità di compiere opere di medie e grandi dimensioni in ferro battuto, acciaio inox e altri metalli.

IL GRANDE FABBRO® is the division of Ind.i.a. S.P.A. that deals with finished works.

This division functions through two channels: the first channel begins with blacksmiths and their cooperation with our head office, as was the case for the restoration of Piazza Vittorio in Rome. The second channel is the direct one: it deals with projects of such mass proportions that entire plans must be finalized face-to-face, as it occurred during the initial and subsequent design phases of wrought iron fencing at Euro Disney in Paris.

One of the reasons IL GRANDE FABBRO® is so exceptional is because the service is always at the disposal of the designer. Whether your project includes: security gating, fencing, purely aesthetic wrought iron works, stainless steel, or other metals, we will be there to help you create exactly what you are looking for. Our skilled technical department, as well as our expert blacksmiths, have worked with each component we produce, and they are able to develop works of any size and complexity. The widespread presence of Ind.i.a. S.P.A., as well as that of its affiliates and distributors in the metal industry, allows the IL GRANDE FABBRO® service to reach fabricators, architects, and designers all over the world. As a matter of fact, Ind.i.a. SPA is a world leader company in the production and distribution of wrought iron and stainless steel components. Therefore, the technical skills, the artistic knowledge, and the flexibility offered by IL GRANDE FABBRO®, make it the ideal service and partner for anyone wishing to establish plans of moderate to large dimensions in wrought iron, stainless steel and other metals.

Bruno Scato

ArteferroCAD

WEB CONFIGURATOR 4.0



Realizzare un cancello, una recinzione, una scala o, in generale, una composizione in Acciaio Inox o ancor più in Ferro Battuto mette l'artigiano nella condizione di dover scegliere tra migliaia di possibilità realizzative a livello estetico. Tale ricchezza è, naturalmente, resa possibile dalla grande varietà di articoli disponibili e dalla possibilità di ottenere da loro molteplici composizioni.

Tale gamma di prodotti, di linee e di motivi che possono essere assemblati, creando ad ogni passaggio differenti effetti, porta l'artigiano in un terreno che molto si avvicina all'arte in quanto la progettazione comporta precise scelte estetiche che ben si adattino all'ambiente dove verranno collocate.

Una delle necessità più frequentemente avvertite dai Fabbri e dai loro clienti è quella di visualizzare la composizione preventivamente al contempo i materiali e stimandone quindi agevolmente i costi, e potendone modificare l'aspetto "con un click". Per venire incontro a tale necessità Ind.i.a. spa da anni abbina ai suoi già riccamente illustrati cataloghi (oltre 2000 foto ambientate) un software di progettazione 3D chiamato Arteferro CAD.

Tale strumento è quindi un aiuto per i fabbri ed architetti nel visualizzare l'effetto di insieme ed inoltre è un efficace strumento di vendita nei confronti del cliente che riesce a visualizzare con immediatezza e efficacia la composizione che desidera, sia essa una scala, un cancello, una recinzione o altro. Per restare al passo con i tempi il software è stato strutturato per essere un prodotto esclusivamente web e verrà reso disponibile nel corso dei primi mesi del 2010.

La principale novità introdotta con la nuova versione del Software, chiamato Arteferro CAD 4 - Web configurator, è la sua fruibilità esclusivamente on-line. Tale scelta è motivata dalla volontà di proporre ai professionisti e agli "Innamorati del Ferro Battuto e dell' Acciaio Inox" un programma che sia costantemente aggiornato tramite l'inserimento di sempre nuovi articoli e composizioni pre-costruite senza il peso di continui aggiornamenti del programma. La libreria di articoli disponibile arriverà a contare oltre 10.000 pezzi selezionati da Ind.i.a. spa e conterrà anche la linea di prestigio "Gonzato Design".

La prima release del programma permette di realizzare composizioni in Ferro Battuto e verrà seguita anche dalla funzione per progettare con l'acciaio Inox.

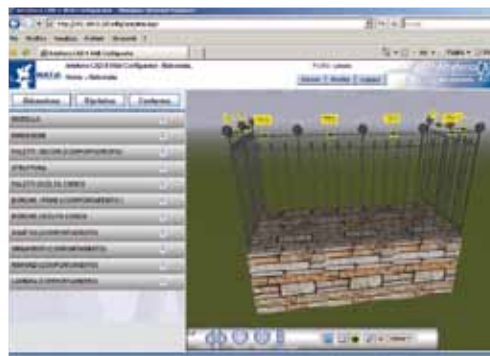

Requisiti per un corretto funzionamento:

Microsoft Internet Explorer 7 - Linea internet - Consigliata scheda grafica 3D con risoluzione video di 1280 x 1024 pixel o superiore

There is true artistic expression in the design of stainless steel and wrought iron products. Craftsmen have thousands of options for gates, fences, staircases, or any other product made from the materials. The vast array of options is made possible by the wide range of items available and by the various methods of combining them. The broad range of product lines and to-be-assembled patterns also inspire the creation of diverse aesthetic effects. Creative uses of wrought iron and stainless steel allow any craftsman the freedom of artistic style, since the creation or design process entails precise aesthetic choices which have to perfectly suit the environment in which they will be placed.

One of the needs most frequently felt by blacksmiths (fabricators) and their customers is the need to visualize designs and evaluate the materials used in those designs at the same time. This allows for easy estimation of costs and the chance to make changes with just a click of the mouse.

Ind.I.A. S.p.A. has strived for years to meet these needs by offering in its catalogues, which are already rich in illustrations with more than 2000 set pictures, a 3D design software program called Arteferro CAD. The software has proven itself a valuable tool in helping blacksmiths, architects and designers visualize and complete entire projects. Furthermore, it is an effective sales tool for attracting customers because; it enables users to play around with model designs, it is fast and easy to use, and it allows users to thoroughly view created designs, whether they are of staircases, gates, fences or something else.

The main change in the new version of the software, called Arteferro CAD 4 Web Configurator, is the fact that it will be offered exclusively online. This choice stems from the wish to offer the product to wrought iron "pros" and to others that have fallen in love with wrought iron and stainless steel. The software program is constantly updated as well, with the addition of new items and pre-built compositions free of charge.

The library of available products included in the software has more than 10,000 pieces, selected by India spa. It also includes the prestigious "Gonzato Design" line. The first release of the software program allows construction of wrought iron designs and will soon be followed by the library application concerning stainless steel.

Requirements for a correct working:

- Microsoft Internet Explorer 7
- Internet line
- A 3D graphic card with video resolution of 1280x1024 or more pixel is recommended

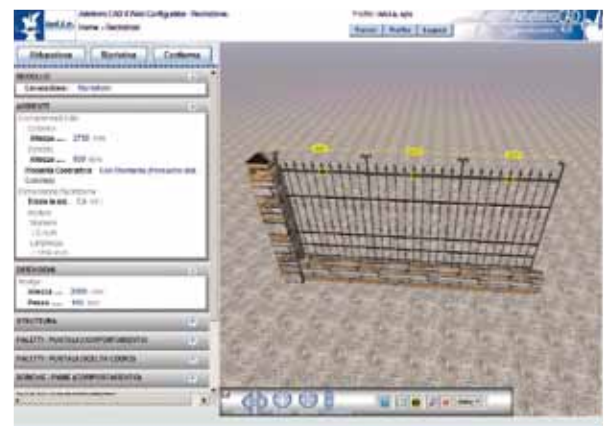



CATALOGHI - CATALOGUES

COMPENDIUM 2011

FERRUMAMANTIBUS - I

da pag./ from page 1 - a pag / to page 416

Art. 212/I



1592 Fotografie. Photographs.

432 Pagine stampate in oro.
Art pages overprinted in gold.

24 Disegni tecnici esplicativi ed esplosi.
Technical and explanatory drawings.

12 Pagine di originali ricerche storiche sul Ferro Battuto dall'antico Egitto ai nostri giorni.
Pages of original historical research on wrought iron production, from the Egyptians to present times.



Art. 1598/2
raccoltore con cataloghi
box with catalogues
(Vol. 1°, 2°, 3°, 4°)

IN FERRO QUALITAS - 3

da pag./ from page 945 - a pag / to page 1610

Art. 1596/I



700 Pagine contenenti foto singole, dati tecnici, suggerimenti tipologici e Foto APPLICATIVE di oltre 4000 articoli in Ferro Battuto per la gran parte di "nuova concezione".

700 Pages full with photos, technical data, actual applications on fences, grills, doors etc. of over 4,000 ready made Wrought Iron forgings.

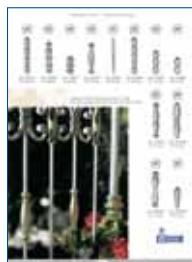

HOMO FABER - 2

da pag./ from page 417 - a pag / to page 944

Art. 938/I



540 Pagine contenenti foto singole, dati tecnici e foto applicative di oltre 3000 articoli "tutti" regolarmente in produzione e disponibili con pronta consegna.

540 pages showing actual pictures, technical data and example pictures of more than 3,000 ready made forgings steadily produced in our own factories and readily available for delivery.



FABER FERRARIUS - 4

da pag./ from page 1611 - a pag / to page 1986

Art. 3005/70



Un migliaio di foto raccontano un lavoro nato trent'anni fa, e cresciuto sino ad affacciarsi prepotentemente al nuovo millennio, sempre con idee innovative e competitive, in grado di soddisfare le nuove realtà economiche mondiali.

A thousand photos tells of a job started thirty years ago and grown overwhelmingly into the new millennium, always with innovative and competitive ideas to satisfy all new economic realities.

CANCELLI GATES BOOK

Art. 939/1
Pagine - Pages 382



LE SCALE STAIRWAYS BOOK

Art. 3005/26
Pagine - Pages 349



PORTE E FINESTRE DOOR and WINDOWS BOOK



Art. 1601/1
Pagine - Pages 296



RECINZIONI E BALCONATE FENCES and RAILINGS BOOK



Art. 1601/2
Pagine - Pages 512



MOBILI D'ARTE Art. 3005/65
ART FURNITURE Pagine - Pages 592
BOOK



OGGETTISTICA Art. 3005/2
ART LINE Pagine - Pages 94



GIARDINAGGIO Art. 3005/1
GARDEN LINE Pagine - Pages 158



DESIGNS
DESIGNS BOOK



Art. 211/2
Pagine - Pages 346

CATALOGO CONVENIENTE 2
CONVENIENT "QUICK
CATALOGUE 2"



Art. 3005/55
Pagine - Pages 128



GONZATO DESIGN

Art. 3005/33
Pagine - Pages 250



ARTEFERRO INOX

Art. 3005/56
Pagine - Pages 400



MANNUS

DISSUASORI IN FERRO,
ALLUMINIO E ACCIAIO INOX
STAINLESS STEEL - ALUMINIUM AND
IRON BOLLARDS



Art. 3005/75
Pagine - Pages 54



PALETTIVERNICIATI Art. 3005/71
POWDER COATED Page - Pages 72
PICKETS



RIASSUNTO Art. 3005/8
ABRIDGED Page - Pages 480

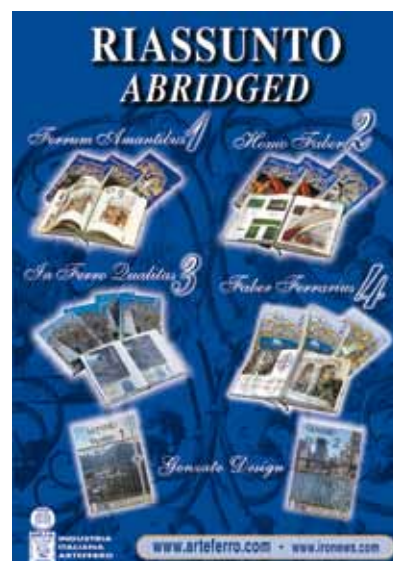

Tutti i volumi dei cataloghi possono essere acquistati direttamente dal sito internet:

All the volumes of the catalogues can be purchased directly from the internet site:

www.arteferro.com

COMPENDIUM Art. 3005/73
 Pagine - Pages 628

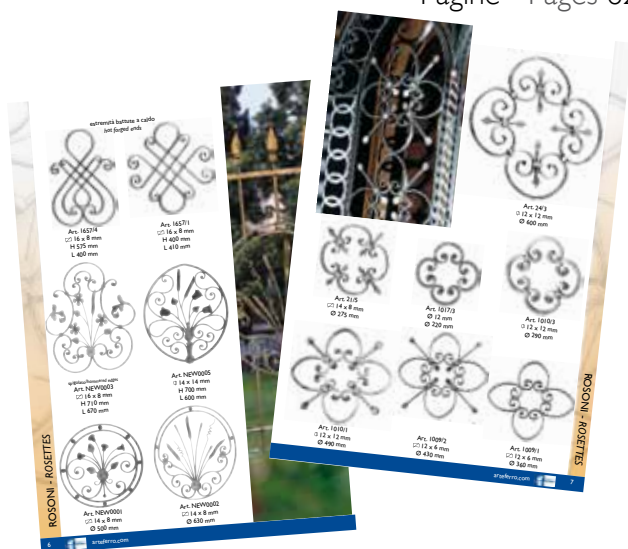

INDICE - INDEX

16/1	66	27/9	68	31/51	49	36/3	76	42/17	303	46/2	279	48/A/9	145
16/2	66	27/10	68	31/52	49	37/1	76	42/18	303	46/3	279	48/A/10	145
16/3	66	27/11	68	31/53	49	37/2	76	42/19	303	46/4	279	48/A/11	145
17/1	56	27/12	68	31/54	49	37/3	75	42/20	303	46/5	279	48/A/12	145
17/2	56	27/13	68	31/55	49	38/1	316	42/21	303	46/6	279	48/B/1	147
18/1	56	27/14	67	31/56	49	38/2	316	42/22	302	46/7	279	48/B/2	147
18/2	56	28/1	68	31/57	49	38/3	316	42/23	302	46/8	279	48/B/3	147
18/3	66	28/2	68	31/58	49	38/4	316	42/24	302	46/9	285	48/B/4	147
18/4	66	28/3	68	31/59	49	38/5	27	42/25	302	46/10	284	48/B/5	147
18/A/1	56	28/4	68	31/60	49	38/6	27	42/26	302	46/11	284	48/B/6	147
18/B/1	71	29/1	68	31/61	49	38/7	27	42/27	302	46/12	284	48/B/7	147
18/B/2	40	29/2	68	31/62	49	38/8	27	42/28	302	47/1	271	48/B/8	147
18/B/3	35	29/3	68	31/63	49	39/1	317	42/A/1	298	47/2	271	49/1	198
18/B/4	71	29/4	68	31/64	49	39/2	317	42/A/2	298	47/3	270	49/2	198
18/B/5	40	29/5	68	31/65	49	40/1	316	42/A/3	298	47/3/1000	270	49/3	176
18/B/6	35	30/1	71	31/66	49	40/2	316	42/A/4	298	47/4	277	49/4	198
19/1	56	30/2	71	31/67	49	40/3	316	42/A/5	299	47/5	271	49/5	176
19/2	56	30/3	71	31/68	49	40/4	316	42/A/6	299	47/6	270	49/6	176
19/3	66	30/4	56	31/69	49	40/5	316	42/A/7	299	47/7	271	49/6	198
19/4	66	30/5	35	31/70	49	40/A/1	316	42/A/8	299	47/8	271	49/7	176
19/5	66	30/6	468	31/71	49	40/A/2	316	42/A/9	303	47/9	270	49/7	198
19/6	66	30/7	56	31/72	49	40/A/3	316	42/A/10	303	47/10	277	49/8	142
20/1	66	31/1	68	31/73	49	40/B/3	317	42/A/11	303	47/11	271	49/9	142
20/2	66	31/2	68	31/74	49	40/B/4	317	42/A/12	303	47/12	270	50/1	198
20/3	66	31/3	68	31/75	49	40/B/5	317	42/A/13	302	47/13	271	50/2	198
20/4	66	31/4	68	31/76	49	40/B/6	317	42/A/14	302	47/14	270	50/3	198
20/5	66	31/5	49	31/77	49	40/B/7	317	42/A/15	302	47/15	270	50/4	198
20/6	66	31/6	49	31/78	49	40/B/8	468	42/A/16	302	47/16	270	50/5	148
21/4	70	31/7	49	31/79	49	40/B/9	468	42/A/17	299	47/17	270	50/6	148
21/5	58	31/8	49	31/80	49	40/B/10	316	42/A/18	299	47/18	270	50/7	176
22/1	70	31/9	49	31/81	49	40/B/11	436	42/B/1	318	47/19	270	50/8	176
22/2	70	31/10	49	31/82	49	40/B/12	436	42/B/2	318	47/20	270	50/9	148
22/3	70	31/11	49	31/83	49	41/1	466	42/B/3	318	47/22	270	50/10	148
22/A/1	70	31/12	49	31/84	49	41/2	318	42/B/4	318	47/23	271	50/11	176
22/A/2	68	31/13	49	31/85	49	41/3	318	42/B/5	334	47/24	270	50/12	176
22/A/3	71	31/14	49	31/86	49	41/4	466	42/B/6	334	47/25	270	50/13	148
22/B/1	70	31/15	49	31/87	49	41/5	466	42/B/7	334	47/26	270	50/14	148
22/B/2	56	31/16	49	31/88	49	41/6	466	42/B/8	334	47/27	270	50/15	176
22/B/3	66	31/17	49	31/89	49	41/7	466	44/1	399	47/28	270	50/16	176
22/B/4	66	31/18	49	31/90	49	41/8	466	44/2	399	47/29	270	51/1	154
22/C/1	66	31/19	49	31/91	49	41/9	466	44/3	399	47/30	270	51/2	154
23/1	56	31/20	49	31/92	49	41/10	466	44/4	399	47/31	270	51/3	119
23/2	66	31/21	49	31/93	49	41/11	466	44/5	399	47/32	270	51/4	154
23/3	66	31/22	49	31/94	49	41/12	466	44/6	399	47/33	270	51/5	154
24/1	57	31/23	49	31/95	49	41/13	466	44/7	399	47/34	270	51/6	119
24/2	57	31/24	49	31/96	49	41/14	466	44/11	279	47/35	270	52/1	78
24/3	58	31/25	49	31/97	49	41/15	466	44/12	279	47/36	270	52/2	176
24/B/1	67	31/26	49	31/98	49	41/16	466	44/13	279	47/37	270	52/A/2	176
24/C/1	70	31/27	49	31/99	49	41/17	466	44/14	279	47/38	270	52/A/3	155
24/C/2	70	31/28	49	31/100	49	41/18	466	45/1	284	48/1	145	52/A/4	175
24/C/3	67	31/29	49	31/101	49	41/19	466	45/2	284	48/2	145	52/A/5	155
24/E/1	70	31/30	49	31/102	49	41/20	466	45/3	284	48/3	145	52/B/1	198
24/F/1	119	31/31	49	31/103	49	41/21	466	45/4	284	48/4	145	52/B/2	198
24/F/2	32	31/32	49	31/104	49	41/22	466	45/5	284	48/5	198	52/B/3	198
26/1	66	31/33	49	31/105	49	41/23	466	45/6	284	48/6	145	52/E/1	175
26/2	66	31/34	49	31/106	49	41/24	466	45/7	284	48/7	145	52/E/2	198
26/3	68	31/35	49	31/107	49	42/1	298	45/8	284	48/8	145	52/E/3	198
26/4	68	31/36	49	31/108	49	42/2	298	45/9	284	48/9	145	52/E/4	198
26/5	68	31/37	49	31/109	49	42/3	298	45/10	284	48/10	198	52/E/5	119
26/A/1	69	31/38	49	31/110	49	42/4	298	45/11	284	48/11	145	52/E/6	119
26/A/2	69	31/39	49	33/1	68	42/5	298	45/12	284	48/12	145	52/F/1	197
26/B/1	69	31/40	49	33/2	56	42/6	298	45/13	284	48/13	145	52/F/2	195
26/B/2	69	31/41	49	33/3	71	42/7	298	45/14	284	48/14	145	52/G/1	79
26/C/1	54	31/42	49	34/1	71	42/8	299	45/15	284	48/15	198	52/H/1	31
27/1	68	31/43	49	34/2	437	42/9	299	45/16	284	48/A/1	145	52/H/2	31
27/2	68	31/44	49	34/3	468	42/10	299	45/17	284	48/A/2	145	52/H/3	71
27/3	68	31/45	49	34/A/1	119	42/11	299	45/18	284	48/A/3	145	52/H/4	197
27/4	68	31/46	49	34/A/1	355	42/12	299	45/19	284	48/A/4	145	52/H/5	197
27/5	68	31/47	49	35/1	74	42/13	299	45/20	284	48/A/5	145	53/1	197
27/6	68	31/48	49	35/2	76	42/14	299	45/21	284	48/A/6	145	53/2	197
27/7	68	31/49	49	36/1	75	42/15	303	45/22	284	48/A/7	145	53/3	141
27/8	68	31/50	49	36/2	74	42/16	303	46/1	279	48/A/8	145	55/1	197

INDICE - INDEX

55/2	197	64/F/1	229	67/7	196	74/14	14	78/11	16	80/C/25	16	88/A/2	34
55/3	142	64/F/2	149	67/8	196	74/15	14	78/12	16	80/C/26	16	88/A/3	19
55/4	142	64/F/3	149	68/1	120	74/16	14	78/13	16	81/1	27	88/A/4	35
55/5	197	64/F/4	149	68/2	119	74/17	14	78/14	16	81/2	468	88/A/5	36
55/6	197	64/F/5	149	69/1	119	74/18	14	78/B/1	24	81/3	19	88/A/6	36
56/1	197	64/F/6	156	69/2	119	74/19	14	78/B/2	24	81/4	468	88/B/1	39
56/2	197	64/F/7	156	69/3	119	74/20	14	78/B/3	24	81/5	19	88/B/2	38
56/3	197	64/F/8	156	69/4	120	74/21	14	78/B/4	24	81/6	468	88/B/3	43
56/4	197	64/F/9	156	70/1	119	74/22	14	78/B/5	24	81/7	30	88/B/4	42
56/5	197	64/G/1	196	70/2	119	74/23	14	78/B/6	24	81/8	468	88/C/1	42
56/6	197	64/G/2	196	70/A/1	190	74/24	14	78/B/7	292	82/1	30	88/C/2	294
57/1	197	64/G/3	27	70/A/2	190	74/25	14	78/B/8	292	82/2	468	88/C/3	294
57/2	197	64/G/4	27	70/A/3	190	74/26	14	78/B/9	292	82/3	30	88/D/1	40
57/3	197	64/G/5	27	70/A/4	190	74/27	14	78/B/10	292	82/4	468	88/D/2	40
57/4	197	64/G/6	27	70/B/1	199	74/28	14	78/B/11	292	82/5	30	88/D/3	41
58/1	119	64/G/7	27	70/B/2	199	75/1	292	78/B/12	292	82/6	468	88/E/1	42
58/2	197	64/G/8	27	70/B/3	199	75/2	292	79/1	296	82/7	30	88/E/2	42
58/3	197	64/G/9	27	70/B/4	199	75/3	292	79/2	296	82/8	468	88/E/3	36
59/1	118	64/G/10	27	70/B/5	199	75/4	292	79/3	296	83/1	43	88/E/4	34
59/2	118	64/H/1	283	70/B/6	42	75/5	292	79/4	296	83/2	468	88/E/5	42
59/3	118	64/H/2	283	70/B/7	468	75/6	292	79/5	296	83/3	468	88/G/1	40
59/4	118	64/H/3	283	70/D/1	143	75/7	292	79/6	296	83/4	468	88/G/2	40
59/5	118	64/H/4	283	70/D/2	141	75/8	292	79/7	293	83/5	468	88/G/3	24
59/6	118	64/H/5	283	70/D/3	141	75/9	292	79/8	293	83/6	468	88/G/4	35
59/7	118	64/H/6	283	70/D/4	273	75/10	292	79/9	293	83/7	468	88/G/5	43
59/8	118	64/H/7	283	70/D/5	273	75/11	292	79/10	293	83/8	468	88/G/6	38
60/1	198	64/H/8	283	70/D/6	282	75/12	292	80/A/1	14	83/9	468	88/H/1	15
60/2	198	64/H/9	275	70/D/7	282	75/13	292	80/A/3	14	83/10	468	88/H/2	15
60/3	197	64/H/10	275	70/D/8	282	75/14	292	80/A/9	15	83/11	468	88/H/3	15
60/4	197	64/H/11	283	70/D/9	273	75/15	292	80/A/10	15	83/12	468	88/H/4	15
61/1	195	64/H/12	283	70/E/1	120	75/16	292	80/A/11	15	83/13	468	88/H/5	15
61/2	195	64/H/13	283	70/E/2	120	75/17	292	80/A/12	15	84/1	36	88/H/6	15
61/3	195	64/H/14	283	70/E/3	120	75/18	292	80/A/13	14	84/2	36	88/I/1	38
61/4	195	64/H/15	283	70/E/4	120	75/19	292	80/A/14	14	84/3	36	88/I/2	36
62/1	80	64/H/16	283	70/E/5	120	75/20	292	80/A/15	14	84/4	36	88/I/3	36
62/2	80	64/H/17	283	70/E/6	120	75/21	30	80/A/16	14	84/5	37	88/L/1	36
63/1	80	64/H/18	283	70/E/7	120	75/22	30	80/A/17	15	84/6	36	88/L/2	398
63/2	80	64/H/19	275	70/E/8	120	75/23	30	80/A/18	15	84/7	29	88/L/2	468
63/3	80	64/H/20	275	71/1	292	75/24	30	80/A/19	15	84/8	40	88/L/3	38
63/4	80	64/I/1	229	71/2	292	75/25	30	80/A/20	15	85/1	468	88/L/4	292
64/1	286	64/I/2	162	71/3	292	75/26	30	80/A/21	14	85/3	40	88/M/1	36
64/2	118	64/I/3	162	71/4	292	75/27	30	80/A/22	14	85/4	35	88/M/2	30
64/2	197	64/I/4	148	71/5	292	75/28	30	80/A/23	14	85/5	35	88/M/3	33
64/A/1	196	64/I/5	148	71/6	292	75/29	30	80/A/24	15	85/6	468	88/M/4	43
64/A/2	196	64/L/1	139	72/1	293	75/30	30	80/A/25	15	85/7	36	88/M/5	35
64/A/3	196	64/L/2	139	72/2	293	75/31	39	80/A/26	15	85/8	253	88/N/1	39
64/A/4	196	64/L/3	139	72/3	293	75/32	39	80/A/27	15	85/9	253	88/N/2	39
64/A/5	196	64/L/4	139	72/4	292	75/33	39	80/A/28	14	86/1	42	88/N/3	38
64/A/6	196	65/1	117	72/5	118	75/34	42	80/A/29	14	86/2	42	88/N/4	34
64/A/7	196	65/2	117	72/6	118	76/1	30	80/A/30	14	86/3	40	88/N/5	36
64/A/8	196	65/3	117	72/7	293	76/2	30	80/B/1	43	86/4	42	88/N/6	35
64/B/1	196	65/4	117	72/8	293	76/3	30	80/B/3	15	86/5	19	88/N/7	35
64/B/2	196	65/5	117	72/9	293	76/4	43	80/B/6	43	86/6	34	88/N/8	39
64/B/3	117	65/6	117	72/10	293	76/5	43	80/B/8	15	87/1	19	88/N/9	39
64/B/4	196	65/7	141	72/11	293	77/1	42	80/C/7	16	87/2	42	88/N/10	38
64/B/5	196	65/8	141	72/12	293	77/2	42	80/C/8	16	87/3	30	88/N/11	34
64/D/1	283	66/1	147	73/1	27	77/3	34	80/C/9	16	87/4	36	88/N/12	36
64/D/2	283	66/2	147	73/2	27	77/4	34	80/C/10	16	87/5	19	88/N/13	35
64/D/3	274	66/3	147	73/3	27	77/5	34	80/C/11	16	87/6	19	88/P/1	24
64/D/4	274	66/4	147	74/1	14	77/6	34	80/C/12	16	88/1	42	88/P/2	24
64/D/5	274	66/5	196	74/2	14	77/7	34	80/C/13	16	88/2	42	88/P/3	24
64/D/6	274	66/6	196	74/3	14	77/8	34	80/C/14	16	88/3	42	88/Q/1	190
64/D/7	274	66/7	196	74/4	14	78/1	16	80/C/15	16	88/4	30	88/Q/2	345
64/D/8	274	66/8	196	74/5	14	78/2	16	80/C/16	16	88/5	30	88/Q/3	346
64/D/9	274	66/9	196	74/6	14	78/3	16	80/C/17	16	88/6	30	88/Q/4	292
64/D/10	274	66/10	196	74/7	14	78/4	16	80/C/18	16	88/7	37	89/1	36
64/E/1	196	67/1	196	74/8	14	78/5	16	80/C/19	16	88/8	37	89/2	27
64/E/2	196	67/2	196	74/9	14	78/6	16	80/C/20	16	88/9	19	89/3	27
64/E/3	196	67/3	196	74/10	14	78/7	16	80/C/21	16	88/10	19	89/4	398
64/E/4	42	67/4	196	74/11	14	78/8	16	80/C/22	16	88/11	50	89/4	468
64/E/5	42	67/5	196	74/12	14	78/9	16	80/C/23	16	88/12	50	90/1	19
64/E/6	42	67/6	196	74/13	14	78/10	16	80/C/24	16	88/A/1	30	90/2	37

INDICE - INDEX

91/1	37	94/E/1	110	109/3	127	114/B/6	247	116/A/18	402	118/18	261	118/C/25	334
91/2	190	94/E/2	110	110/3	130	114/B/7	247	116/A/19	402	118/19	261	118/C/26	334
91/3	190	94/E/3	110	110/4	130	114/B/8	247	116/A/20	402	118/20	261	118/C/27	334
91/4	190	94/E/4	110	110/5	130	114/B/9	245	116/A/21	402	118/21	261	118/C/27/1200	334
91/5	190	94/E/5	110	110/6	130	114/B/10	246	116/A/22	402	118/22	261	118/C/28	334
91/6	37	94/E/6	110	110/8	345	114/B/11	246	116/B/1	498	118/23	261	118/C/28/1200	334
92/1	37	94/F/1	110	110/9	396	114/B/12	246	116/B/2	498	118/24	256	118/C/29	334
92/A/1	119	94/F/2	110	111/2	133	114/B/13	234	116/D/1	354	118/25	256	118/C/30	334
92/A/2	119	94/F/3	110	111/3	232	114/B/14	234	116/D/2	353	118/26	261	118/C/31	334
92/A/3	71	94/F/4	110	112/1	227	114/B/15	234	116/D/3	355	118/27	261	118/C/32	334
92/B/1	31	94/F/5	110	112/2	227	115/1	249	116/D/4	355	118/28	261	118/C/33	334
92/B/2	31	94/F/6	110	112/3	225	115/2	239	116/E/1	354	118/29	261	118/C/34	334
92/B/3	28	94/P/1	20	112/4	225	115/3	239	116/E/2	354	118/30	261	118/C/35	334
92/B/4	28	94/P/2	20	112/5	223	115/4	249	116/E/3	356	118/A/1	261	118/C/36	334
92/B/5	120	94/P/3	20	112/6	223	115/5	249	116/E/4	356	118/A/2	261	118/C/37	334
92/C/1	295	94/P/4	20	112/7	222	116/1	248	116/E/5	117	118/A/3	261	118/C/38	334
92/C/2	295	94/P/5	20	112/8	222	116/2	245	116/E/6	354	118/A/4	261	118/C/39	334
92/C/3	42	94/P/6	20	112/9	227	116/3	247	116/F/1	382	118/A/5	261	118/C/39/1200	334
92/C/4	28	94/P/7	20	112/10	227	116/4	247	116/F/2	382	118/A/6	261	118/C/40	334
92/C/5	28	94/P/8	20	112/11	227	116/5	247	116/F/3	382	118/A/7	261	118/C/40 T16	334
92/D/1	31	94/P/9	20	112/B/1	225	116/6	245	116/F/4	382	118/A/8	261	118/C/41	334
92/D/2	31	94/P/10	20	112/B/2	225	116/7	246	116/F/5	382	118/A/9	261	118/C/42	334
92/D/3	43	94/P/11	20	112/B/3	225	116/8	246	116/F/6	382	118/A/10	260	118/C/42/1200	334
92/D/3	294	94/P/12	20	112/B/4	225	116/9	248	116/F/7	382	118/A/11	260	118/C/43	334
92/D/4	43	94/Q/1	20	112/B/5	225	116/10	245	116/F/8	382	118/A/12	260	118/C/44	334
92/D/4	294	94/Q/2	20	112/B/6	225	116/11	247	116/F/9	382	118/A/13	260	118/C/44/1200	334
92/D/5	31	94/Q/3	20	112/B/7	225	116/12	247	116/F/10	382	118/A/14	260	118/C/45	334
93/1	31	94/Q/4	20	112/B/8	225	116/13	247	116/F/11	384	118/A/15	260	118/C/46	334
93/2	31	94/Q/5	20	112/B/9	226	116/14	245	116/F/12	384	118/A/16	260	118/C/47	334
93/3	31	94/Q/6	20	112/B/10	226	116/15	246	116/F/13	384	118/A/17	259	118/C/48	334
93/4	28	94/Q/7	20	112/B/11	226	116/16	246	116/F/14	384	118/A/18	259	118/C/48 T16	334
94/1	31	94/Q/8	20	112/B/12	226	116/17	248	116/F/15	384	118/A/19	259	118/C/49	334
94/2	28	96/1	136	112/B/13	226	116/18	245	116/F/16	384	118/A/20	259	118/C/49 T16	334
94/3	31	96/2	132	112/B/14	226	116/19	247	116/F/17	382	118/A/21	259	118/C/50	334
94/A/1	467	96/3	136	112/B/15	226	116/20	247	116/F/18	384	118/A/22	259	118/C/51	334
94/A/2	467	96/4	136	112/B/16	226	116/21	247	116/F/19	382	118/A/23	259	118/C/52	334
94/A/3	406	97/1	199	113/1	226	116/22	245	117/1	382	118/A/44	259	118/C/53	334
94/A/4	406	97/2	199	113/2	226	116/23	246	117/2	382	118/B/1	143	118/C/54	334
94/A/5	406	97/3	199	113/3	226	116/24	246	117/3	382	118/B/2	142	118/C/55	334
94/A/6	406	98/1	127	113/4	226	116/25	248	117/4	382	118/B/3	142	118/C/56	334
94/A/7	407	98/B/1	277	113/5	225	116/26	245	117/5	382	118/B/4	142	118/C/57	334
94/A/8	407	98/B/2	199	113/6	225	116/27	247	117/6	382	118/B/5	143	118/C/58	334
94/B/1	428	98/B/3	199	113/7	225	116/28	247	117/7	382	118/C/1	334	118/C/59	334
94/B/2	422	99/1	126	113/8	225	116/29	247	117/8	382	118/C/1 Q16	334	118/C/60	334
94/B/3	428	99/2	126	113/9	402	116/30	245	117/9	382	118/C/2	334	118/C/61	334
94/B/4	428	100/3	137	113/10	402	116/31	246	117/10	266	118/C/3	334	118/C/62	334
94/B/5	421	101/1	136	113/11	382	116/32	246	117/11	266	118/C/4	334	118/C/63	334
94/B/6	421	101/2	136	113/12	382	116/33	467	117/12	266	118/C/5	334	118/C/63	392
94/B/7	419	102/1	136	114/1	249	116/34	467	117/13	266	118/C/6	334	118/C/64	334
94/B/8	419	102/3	199	114/2	239	116/35	467	117/14	266	118/C/7	334	118/C/64	392
94/B/9	419	102/4	199	114/4	245	116/35	405	117/15	382	118/C/7 Q16	334	118/C/65	334
94/B/10	419	103/1	119	114/5	245	116/36	246	117/16	382	118/C/8	334	118/C/65	392
94/B/11	419	103/2	119	114/6	247	116/37	246	118/1	256	118/C/9	334	118/C/66	334
94/B/12	419	104/3	132	114/7	247	116/38	246	118/2	256	118/C/10	334	118/C/66	392
94/B/13	419	104/4	132	114/8	247	116/39	246	118/3	256	118/C/11	334	118/C/67	334
94/B/14	419	104/5	132	114/9	244	116/A/1	405	118/4	256	118/C/12	334	118/C/67	392
94/B/15	419	105/1	122	114/9	256	116/A/2	406	118/5	256	118/C/13	334	118/C/68	334
94/B/16	419	105/2	122	114/10	245	116/A/3	410	118/6	256	118/C/13/1200	334	118/C/68	392
94/C/1	31	105/3	122	114/11	246	116/A/4	410	118/7	244	118/C/14	334	118/C/106	334
94/C/2	31	105/4	122	114/12	246	116/A/5	410	118/7	256	118/C/15	334	118/E/1	257
94/C/3	31	105/5	122	114/13	245	116/A/6	404	118/8	244	118/C/16	334	118/E/2	257
94/C/4	31	105/6	122	114/A/1	238	116/A/7	404	118/8	256	118/C/16/1200	334	118/E/3	257
94/C/5	31	105/7	122	114/A/2	238	116/A/8	248	118/10	261	118/C/17	334	118/E/4	257
94/C/6	31	106/1	199	114/A/3	234	116/A/9	245	118/11	261	118/C/18	334	118/E/5	257
94/C/7	31	106/2	137	114/A/4	248	116/A/10	247	118/12	261	118/C/19	334	118/E/6	257
94/C/8	31	107/1	199	114/A/5	251	116/A/11	247	118/13	246	118/C/20	334	118/E/7	257
94/C/9	110	107/2	189	114/A/6	251	116/A/12	247	118/13	261	118/C/20/1200	334	118/E/8	257
94/C/10	110	108/1	136	114/B/1	238	116/A/13	245	118/14	246	118/C/21	334	118/E/9	257
94/C/11	110	108/2	136	114/B/2	238	116/A/14	246	118/14	261	118/C/22	334	118/E/10	257
94/C/12	110	108/A/1	130	114/B/3	239	116/A/15	246	118/15	261	118/C/23	334	118/E/13	257
94/C/13	110	108/A/2	130	114/B/4	248	116/A/16	246	118/16	261	118/C/23/1200	334	118/E/14	257
94/C/14	110	109/2	284	114/B/5	245	116/A/17	402	118/17	261	118/C/24	334	118/E/15	257

INDICE - INDEX

118/E/16	257	119/28	141	126/B/9	388	128/30	380	130/13	329	131/20	333	132/34	332
118/E/17	257	119/28	224	126/C/1	396	128/31	378	130/14	329	131/21	333	132/35	332
118/F/1	266	120/1	395	126/C/2	390	128/31	403	130/15	329	131/22	333	132/36	332
118/F/2	266	120/2	395	126/C/3	388	128/32	380	130/16	329	131/23	333	132/37	332
118/F/3	266	120/3	395	126/C/4	388	128/33	380	130/17	329	131/24	333	132/38	332
118/F/4	266	121/1	390	126/C/5	388	128/34	380	130/18	329	131/25	333	132/39	332
118/F/5	266	121/2	390	126/C/6	399	128/35	378	130/19	329	131/26	333	132/40	346
118/F/6	266	121/3	390	126/C/7	399	128/36	363	130/20	329	131/27	333	132/41	346
118/F/7	250	121/4	394	126/C/8	399	128/37	363	130/21	329	131/28	333	132/42	346
118/F/8	250	121/5	394	126/C/9	396	128/38	363	130/22	329	131/29	333	132/43	345
118/F/9	250	121/6	394	126/D/1	399	128/39	363	130/23	329	131/30	333	132/44	345
118/F/10	250	121/7	394	126/E/1	389	128/B/1	373	130/24	329	131/31	332	132/45	345
118/H/1	142	121/8	394	126/E/2	396	128/B/2	373	130/25	329	131/32	332	132/46	345
118/H/2	142	121/9	394	126/F/1	360	128/C/1	380	130/26	329	131/33	332	132/47	345
118/H/3	141	122/1	390	126/F/2	360	128/C/2	380	130/27	329	131/34	332	132/48	345
118/H/4	141	122/2	390	126/F/3	360	128/C/3	364	130/28	329	131/35	332	132/49	345
118/H/5	263	122/3	390	126/F/4	360	128/C/4	364	130/29	329	131/36	332	132/50	345
118/H/6	263	122/4	399	126/F/5	360	128/C/5	364	130/30	329	131/37	332	132/51	345
118/H/7	263	122/5	399	126/F/6	361	128/C/6	364	130/31	322	131/38	332	132/52	345
118/H/8	263	122/6	390	126/F/7	361	128/C/7	364	130/32	322	131/39	332	132/A/1	333
118/H/9	263	122/A/1	395	126/F/8	361	128/C/8	364	130/33	322	131/40	332	132/A/2	333
118/H/10	263	122/B/1	395	126/F/9	361	128/C/9	364	130/34	322	131/41	332	132/A/3	333
118/H/11	263	123/1	382	126/F/10	361	128/C/10	364	130/35	322	131/42	332	132/A/4	333
118/H/12	263	123/2	399	126/F/11	371	128/C/11	364	130/36	322	131/43	332	132/A/5	333
118/H/13	263	123/3	394	126/F/12	363	128/C/12	364	130/37	322	131/44	332	132/A/6	333
118/H/14	263	123/4	390	126/F/13	363	128/C/13	364	130/38	322	131/45	332	132/A/7	333
118/H/15	263	123/5	394	126/F/14	363	128/C/14	364	130/39	322	131/46	332	132/A/8	333
118/H/16	263	123/6	390	127/1	390	128/C/15	364	130/40	322	131/47	332	132/A/9	333
118/H/17	263	123/7	396	127/2	390	128/D/1	329	130/41	327	131/48	332	132/A/10	333
118/H/18	263	124/1	386	127/3	360	128/D/2	329	130/42	327	131/49	332	132/A/11	333
118/H/19	263	124/2	386	127/4	360	128/D/3	329	130/43	327	131/50	332	132/A/12	333
118/H/20	263	124/3	387	127/5	362	128/D/4	329	130/44	327	131/51	332	132/A/13	333
118/H/21	263	124/4	387	127/6	362	128/D/5	329	130/45	327	131/52	332	132/A/14	333
118/H/22	263	124/5	387	127/7	362	128/D/6	329	130/46	327	131/53	332	132/A/15	333
118/H/23	263	124/6	396	127/8	362	128/D/9	391	130/47	327	131/54	332	132/A/16	333
118/H/24	263	124/7	387	127/9	362	129/1	399	130/48	327	131/55	332	132/A/17	333
118/H/25	263	124/8	396	127/10	362	129/2	399	130/49	327	131/56	332	132/A/18	333
118/H/26	263	124/9	386	127/11	362	129/3	399	130/50	327	131/57	332	132/A/19	333
118/H/27	232	124/11	331	127/12	362	129/4	399	130/51	329	131/58	332	132/A/20	333
118/H/28	232	124/12	331	127/13	362	129/5	393	130/52	329	132/1	332	132/A/21	333
118/H/29	142	124/13	331	127/14	362	129/6	393	130/53	329	132/2	332	132/A/22	333
118/H/30	142	124/14	331	127/15	362	129/7	323	130/54	329	132/3	332	132/A/23	333
119/1	266	125/1	386	127/16	362	129/7	391	130/55	329	132/4	332	132/A/24	333
119/2	266	125/2	386	128/1	363	129/8	323	130/56	329	132/5	332	132/B/1	344
119/3	266	125/3	399	128/2	363	129/8	391	130/57	329	132/6	332	132/B/2	344
119/4	141	125/4	399	128/3	360	129/9	322	130/58	329	132/7	332	132/B/3	344
119/5	141	126/1	394	128/4	360	129/9	391	130/59	329	132/8	332	132/B/4	344
119/6	141	126/2	394	128/5	360	129/10	322	130/60	329	132/9	332	132/B/5	344
119/7	141	126/3	429	128/6	360	129/10	391	130/66	333	132/10	332	132/B/6	344
119/8	141	126/5	396	128/7	360	129/11	327	130/67	333	132/11	347	132/B/7	344
119/9	141	126/6	390	128/8	360	129/11	391	130/68	333	132/12	347	132/B/8	344
119/10	141	126/7	390	128/9	360	129/12	327	130/69	333	132/13	347	132/B/9	344
119/11	141	126/8	386	128/10	360	129/12	391	130/70	333	132/14	332	132/B/10	344
119/12	141	126/9	390	128/11	360	129/14	398	131/1	333	132/15	332	132/B/11	344
119/13	141	126/13	396	128/12	360	129/15	396	131/2	333	132/16	332	132/B/12	344
119/14	141	126/14	396	128/13	360	129/16	391	131/3	333	132/17	332	132/B/13	344
119/15	141	126/15	394	128/14	360	129/17	393	131/4	333	132/18	332	132/B/14	344
119/16	141	126/16	394	128/15	360	129/18	393	131/5	333	132/19	332	132/B/15	344
119/17	141	126/17	396	128/16	361	129/19	391	131/6	333	132/20	332	132/B/16	344
119/18	141	126/18	394	128/17	361	129/20	391	131/7	333	132/21	332	132/B/17	344
119/19	141	126/19	390	128/18	361	130/1	323	131/8	333	132/22	332	132/B/18	344
119/20	141	126/20	390	128/19	361	130/2	323	131/9	333	132/23	332	132/B/19	344
119/21	141	126/21	386	128/20	361	130/3	323	131/10	333	132/24	333	132/B/20	344
119/22	141	126/A/1	389	128/21	361	130/4	323	131/11	333	132/25	333	132/B/21	344
119/23	141	126/B/1	387	128/22	361	130/5	323	131/12	333	132/26	333	132/B/22	344
119/24	141	126/B/2	387	128/23	361	130/6	323	131/13	333	132/27	332	132/B/23	344
119/25	141	126/B/3	387	128/24	361	130/7	323	131/14	333	132/28	332	132/B/24	344
119/25	225	126/B/4	396	128/25	361	130/8	323	131/15	333	132/29	332	132/B/25	344
119/26	141	126/B/5	396	128/26	361	130/9	323	131/16	333	132/30	332	132/B/26	344
119/26	225	126/B/6	387	128/27	361	130/10	323	131/17	333	132/31	332	132/B/27	344
119/27	141	126/B/7	387	128/28	361	130/11	329	131/18	333	132/32	332	132/B/28	344
119/27	224	126/B/8	387	128/29	380	130/12	329	131/19	333	132/33	332	132/B/29	344

INDICE - INDEX

132/B/30	344	132/C/15	338	134/23	346	134/F/4	199	140/C/2	431	152/6	295	157/6	46
132/B/31	344	132/C/15	392	134/24	346	134/F/5	199	140/C/3	431	152/7	295	157/7	46
132/B/32	344	132/C/16	338	134/25	346	134/F/6	200	140/C/4	431	152/8	295	157/8	46
132/B/33	344	132/C/16	392	134/26	346	134/F/7	200	140/D/1	431	152/9	295	157/9	46
132/B/34	344	132/C/17	338	134/27	346	134/F/8	200	140/D/2	431	152/10	295	157/10	46
132/B/35	344	132/C/17	392	134/28	346	134/G/1	200	140/D/3	431	153/1	286	157/11	46
132/B/36	344	132/C/18	338	134/29	282	134/G/2	200	140/D/4	433	153/2	39	157/12	46
132/B/37	338	132/C/18	392	134/30	282	134/G/3	143	140/E/1	431	154/1	370	157/13	46
132/B/38	338	132/C/19	338	134/31	282	134/G/4	143	140/E/2	431	154/2	370	157/14	46
132/B/39	338	132/C/19	392	134/32	282	134/H/1	200	140/E/3	431	154/3	370	157/15	46
132/B/40	338	132/C/20	338	134/33	282	134/H/2	200	140/F/1	431	154/4	370	157/16	50
132/B/41	338	132/C/20	392	134/34	282	135/1	345	140/F/2	431	154/5	370	157/17	150
132/B/42	338	132/C/21	338	134/35	282	135/2	345	140/F/3	431	154/6	182	157/18	150
132/B/43	338	132/C/21	392	134/36	282	135/3	318	140/F/4	431	154/7	182	158/1	254
132/B/44	338	132/C/22	338	134/37	282	136/1	411	140/H/1	413	154/8	182	158/2	254
132/B/45	338	132/C/22	392	134/38	282	136/2	411	140/H/2	413	154/9	182	158/3	252
132/B/46	338	132/C/23	338	134/39	282	136/3	411	140/H/3	412	154/10	182	158/4	253
132/B/47	338	132/C/23	392	134/40	282	136/4	411	140/H/4	412	154/11	182	158/5	255
132/B/48	338	132/C/25	338	134/41	282	136/5	423	140/I/1	427	154/12	182	158/6	255
132/B/49	338	132/C/28	338	134/42	282	136/6	423	140/I/2	417	154/13	182	158/7	255
132/B/50	338	132/C/29	338	134/43	282	136/7	423	140/I/3	416	154/14	182	158/8	255
132/B/51	338	132/C/30	392	134/44	282	136/8	423	140/I/4	427	154/15	182	158/9/C	235
132/B/52	338	132/C/31	392	134/45	282	136/9	423	141/1	207	154/A/1	370	158/10/C	235
132/B/53	338	132/D/1	338	134/46	282	136/10	411	141/2	207	154/A/2	370	158/12/C	235
132/B/54	338	132/D/2	338	134/47	282	136/11	411	141/3	207	154/A/3	370	158/13	254
132/B/55	338	132/D/3	338	134/48	282	136/12	411	141/4	207	154/A/4	370	158/14	254
132/B/56	338	132/D/4	338	134/A/1	138	136/13	411	141/5	207	154/A/5	370	158/15	254
132/B/57	338	132/D/5	338	134/A/2	138	137/1	430	141/6	207	154/A/6	370	158/16	254
132/B/58	338	132/D/6	338	134/A/3	138	137/2	430	142/1	207	154/A/7	370	158/17	254
132/B/59	338	132/D/7	338	134/A/4	138	137/4	430	142/2	207	154/A/8	370	158/18	254
132/B/60	338	132/D/8	338	134/A/5	139	137/7	413	142/3	207	154/B/1	370	158/19	254
132/B/61	338	132/D/9	338	134/A/6	139	137/8	413	142/4	286	154/B/2	370	158/20	252
132/B/62	338	132/D/10	338	134/A/7	139	137/9	423	142/5	207	154/B/3	370	158/21	252
132/B/63	338	132/D/11	338	134/A/8	139	137/10	423	142/6	207	154/B/4	370	158/22	252
132/B/64	338	132/D/12	338	134/A/9	139	137/11	430	142/7	207	154/B/5	370	158/23	252
132/B/65	338	132/D/13	338	134/A/10	139	137/12	407	142/8	207	154/B/6	370	158/24	252
132/B/66	338	132/D/14	338	134/A/11	346	137/13	407	144/3	185	154/B/7	182	158/25	252
132/B/67	338	132/D/15	338	134/A/12	346	137/14	407	145/3	232	154/B/8	182	158/26	252
132/B/68	338	132/D/16	338	134/A/13	346	138/1	420	145/4	232	154/B/9	182	158/27	252
132/B/69	338	132/D/17	338	134/A/14	346	138/2	405	145/5	232	154/B/10	182	158/28	252
132/B/70	338	132/D/18	338	134/A/15	346	138/3	414	146/1	161	154/B/11	182	158/29	252
132/B/71	338	132/D/19	338	134/A/16	346	138/4	414	146/2	161	154/B/12	182	158/30	252
132/B/72	338	132/D/20	338	134/B/1	193	138/5	414	146/3	186	155/1	370	158/31	253
132/B/73	344	133/1	345	134/B/2	193	138/6	414	146/4	186	155/2	370	158/32	253
132/B/74	344	133/2	345	134/B/3	193	138/7	431	147/1	186	155/3	370	158/33	253
132/B/75	344	133/6	345	134/B/4	193	138/8	417	147/2	186	155/4	370	158/34	255
132/B/76	344	133/7	345	134/B/5	193	138/9	417	147/3	406	155/5	370	158/35	255
132/B/77	344	133/8	345	134/B/6	193	138/10	417	148/1	186	155/6	370	158/36	255
132/B/78	344	133/9	345	134/C/1	193	138/11	412	148/2	186	155/7	370	158/37	255
132/B/79	344	133/10	345	134/C/2	193	138/12	412	149/1	161	156/1	50	158/38	255
132/B/80	344	134/1	138	134/C/3	193	138/13	412	149/2	161	156/2	50	158/39	255
132/B/85	338	134/2	138	134/C/4	193	138/14	414	149/3	183	156/3	50	158/40	255
132/B/86	338	134/3	138	134/C/5	193	138/15	420	150/1	182	156/4	50	158/41	255
132/B/87	338	134/4	138	134/C/6	193	138/16	430	150/2	182	156/5	50	158/42	255
132/B/88	338	134/5	139	134/D/1	193	139/1	422	150/3	182	156/6	50	158/43	255
132/C/1	338	134/6	139	134/D/2	193	139/2	422	150/4	182	156/A/1	51	158/44	255
132/C/2	338	134/7	139	134/D/3	193	139/3	422	150/5	182	156/A/2	51	158/45/C	235
132/C/3	338	134/8	139	134/D/4	193	139/4	422	150/6	182	156/A/3	51	158/47/C	235
132/C/4	338	134/9	138	134/D/5	193	139/5	422	150/7	182	156/A/4	51	158/49	254
132/C/5	338	134/10	138	134/D/6	193	139/6	434	150/8	182	156/A/5	51	158/50	254
132/C/6	338	134/11	138	134/D/7	199	140/1	417	150/9	182	156/A/6	50	158/51	254
132/C/7	338	134/12	138	134/D/8	199	140/2	417	151/1	182	156/A/7	481	158/52	254
132/C/8	338	134/13	139	134/D/9	199	140/3	417	151/2	182	156/A/8	481	158/53	254
132/C/9	338	134/14	139	134/D/10	199	140/4	430	151/3	182	156/A/9	481	158/54	254
132/C/10	338	134/15	139	134/E/1	199	140/5	423	151/4	182	156/A/10	481	158/B/1	374
132/C/11	338	134/16	139	134/E/2	194	140/6	423	151/5	182	156/A/11	481	158/B/2	374
132/C/12	338	134/17	323	134/E/3	194	140/7	423	151/6	182	156/A/12	481	158/B/3	374
132/C/12	392	134/18	323	134/E/4	199	140/8	423	152/1	295	157/1	46	158/B/4	374
132/C/13	338	134/19	323	134/E/5	199	140/B/1	430	152/2	295	157/2	46	158/B/5	374
132/C/13	392	134/20	323	134/F/1	199	140/B/2	430	152/3	295	157/3	46	158/B/6	375
132/C/14	338	134/21	323	134/F/2	155	140/B/3	428	152/4	34	157/4	46	158/B/7	375
132/C/14	392	134/22	323	134/F/3	199	140/C/1	431	152/5	295	157/5	46	158/B/8	375

INDICE - INDEX

158/B/9	380	160/C/5	195	161/2	504	168/5	444	171/29	474	186/6	256	213/2	493
158/B/10	380	160/C/6	195	161/3	504	168/6	444	171/30	474	190/5	399	213/3	493
158/B/11	380	160/C/7	505	161/4	504	169/1	448	171/31	474	198/1	468	213/4	493
159/1	374	160/C/8	505	161/5	504	169/2	448	171/32	474	199/1	440	227/1	456
159/2	374	160/C/9	505	161/6	504	169/3	448	171/33	474	199/1	472	227/2	456
159/3	374	160/C/10	505	161/7	504	169/4	454	171/34	474	199/2	440	227/3	456
159/4	374	160/C/11	507	161/8	504	169/5	454	171/35	474	199/2	472	227/4	456
159/5	374	160/C/12	507	161/9	504	169/6	449	171/36	474	199/3	440	227/16	456
159/6	374	160/D/1	503	161/10	504	169/7	449	171/37	466	199/3	472	227/18	456
159/7	374	160/D/2	503	161/11	504	169/8	449	171/38	466	199/4	440	227/20	456
159/8	374	160/D/3	503	161/12	504	169/9	449	171/39	466	199/4	472	227/22	456
159/9	374	160/D/4	503	161/13	504	169/10	449	171/40	466	199/5	440	227/24	456
159/10	374	160/D/5	503	161/14	504	169/11	442	171/41	466	199/5	472	227/27	456
160/1	208	160/D/6	503	161/15	504	169/12	444	171/42	466	199/6	440	227/28	456
160/2	208	160/D/7	503	161/16	504	169/13	444	178/19	379	199/6	472	227/29	456
160/3	208	160/D/8	503	161/17	504	169/14	444	178/20	379	199/7	440	227/30	456
160/4	208	160/D/9	503	161/18	504	169/15	444	178/21	379	199/7	472	227/31	456
160/5	208	160/D/10	503	161/19	504	170/1	449	178/22	379	199/8	440	227/32	456
160/6	208	160/D/11	503	161/20	504	170/2	449	178/23	379	199/8	472	227/33	456
160/7	208	160/D/12	503	161/21	504	170/3	449	178/24	379	199/9	440	227/34	456
160/8	208	160/D/13	503	161/22	504	170/5	449	178/25	379	199/9	472	227/35	456
160/9	208	160/D/14	503	161/23	504	170/6	452	178/26	379	199/10	440	227/36	456
160/10	208	160/D/15	503	161/24	504	170/7	453	178/27	379	199/10	472	227/37	456
160/11	208	160/E/1	200	161/25	504	170/8	492	178/28	379	199/11	440	227/38	456
160/12	208	160/E/2	69	161/31	504	170/9	492	178/29	379	199/11	472	227/39	456
160/13	208	160/E/3	68	161/32	504	170/10	492	178/30	379	199/12	440	227/40	456
160/14	208	160/E/4	69	161/33	504	170/11	492	178/31	379	199/12	472	227/41	456
160/15	208	160/E/5	200	161/34	504	170/12	492	178/32	379	199/13	440	227/42	456
160/16	208	160/E/6	508	161/35	504	170/A/1	453	178/33	379	199/13	472	227/43	456
160/17	208	160/E/7	508	162/1	71	170/A/2	453	178/34	379	199/14	440	227/44	456
160/18	208	160/E/8	508	162/2	71	170/A/3	453	178/35	380	199/14	472	227/45	456
160/19	208	160/E/9	508	162/3	71	170/A/4	453	178/36	380	199/15	440	227/46	456
160/20	208	160/E/10	416	162/4	119	170/A/5	453	178/37	380	199/15	472	227/47	456
160/21	208	160/G/A	508	162/5	119	170/A/6	453	179/3	345	199/16	440	227/48	456
160/22	208	160/G/B	508	162/6	119	170/A/7	453	179/4	345	199/16	472	227/49	456
160/23	208	160/G/C	508	163/1	200	170/A/8	453	179/5	345	199/17	440	227/50	456
160/24	208	160/G/D	508	163/2	120	170/A/9	453	179/6	345	199/17	472	227/51	456
160/25	208	160/G/E	508	163/3	200	170/A/10	453	179/7	345	200/1	319	227/52	456
160/26	208	160/G/F	508	163/4	190	170/A/11	453	179/8	345	200/2	491	227/53	456
160/27	208	160/G/G	508	163/5	190	170/B/1	454	179/9	347	200/3	319	227/54	456
160/28	208	160/G/H	508	164/1	455	170/B/2	454	179/10	347	200/4	320	227/55	456
160/29	208	160/H/A	508	164/2	455	170/B/3	454	180/49	347	200/5	320	227/56	456
160/30	208	160/H/B	508	164/3	455	170/B/4	455	180/50	261	200/6	319	227/57	456
160/31	208	160/H/C	508	164/4	455	170/B/5	454	180/51	261	200/7	319	227/58	456
160/32	208	160/H/D	509	164/5	455	171/1	474	180/53	261	200/8	319	446/1	67
160/33	208	160/H/E	509	164/6	455	171/2	474	180/54	261	200/9	319	446/2	67
160/34	208	160/H/F	509	164/7	455	171/3	474	181/6	406	200/11	319	446/3	68
160/35	208	160/H/G	509	164/8	455	171/4	474	181/7	253	200/12	319	446/4	62
160/36	208	160/H/H	509	164/9	455	171/5	474	181/8	253	200/13	319	447/1	67
160/37	208	160/H/I	509	164/10	455	171/6	474	181/10	442	200/14	319	448/1	67
160/38	208	160/H/IDX	509	164/11	455	171/7	474	181/11	442	200/15	319	449/1	67
160/39	208	160/H/ISX	509	164/12	455	171/8	474	181/12	442	200/16	319	450/1	67
160/40	208	160/H/L	508	164/13	455	171/9	474	181/13	455	200/17	320	451/1	70
160/42	503	160/H/M	508	164/14	455	171/10	474	181/14	455	200/18	320	452/1	67
160/43	506	160/H/N	508	167/3	379	171/11	474	181/15	442	200/19	320	452/2	37
160/44	506	160/H/O	508	167/4	379	171/12	474	182/1	455	200/20	320	452/3	37
160/45	506	160/H/P	508	167/5	379	171/13	474	182/2	455	200/21	320	453/1	68
160/46	506	160/H/Q	508	167/6	379	171/14	474	185/1	141	200/22	320	453/2	68
160/A/1	497	160/I/1	497	167/7	379	171/15	474	185/2	145	201/1	207	453/3	68
160/A/2	497	160/I/2	497	167/8	379	171/16	474	185/4	155	201/2	207	453/4	68
160/A/3	497	160/I/3	497	167/9	379	171/17	474	185/5	196	201/3	207	453/5	68
160/B/1	503	160/I/4	497	167/10	379	171/18	474	185/6	119	202/1	384	453/6	68
160/B/2	503	160/I/5	497	167/11	379	171/19	474	185/7	196	202/2	384	453/7	68
160/B/3	503	160/I/6	497	167/12	379	171/20	474	185/8	196	202/3	384	453/8	119
160/B/4	503	160/L/1	497	167/13	379	171/21	474	185/9	464	202/4	384	453/9	119
160/B/5	503	160/L/2	497	167/14	379	171/22	474	186/1	57	202/5	384	454/1	67
160/B/6	503	160/L/3	497	167/15	379	171/23	474	186/2	66	202/6	384	454/2	66
160/B/7	503	160/L/4	497	167/16	379	171/24	474	186/3	247	202/7	384	454/3	66
160/C/1	195	160/L/5	497	168/1	492	171/25	474	186/3	256	211/1	492	454/4	68
160/C/2	195	160/L/6	496	168/2	451	171/26	474	186/4	244	211/2	598	454/5	67
160/C/3	195	160/L/7	496	168/3	444	171/27	474	186/4	256	212/1	596	454/6	66
160/C/4	195	161/1	504	168/4	444	171/28	474	186/5	256	213/1	493	454/7	66

INDICE - INDEX

454/8	66	490/1	136	511/1	113	537/1	161	565/3	189	577/2	158	585/4	148
455/2	67	490/2	136	512/1	135	537/2	161	565/4	189	577/3	154	586/1	203
456/1	118	491/1	189	512/2	135	537/3	161	566/1	189	577/4	158	586/2	203
456/2	69	491/2	189	513/1	135	537/4	161	566/2	189	577/5	158	586/3	203
456/3	118	491/3	48	513/2	135	537/5	161	566/3	189	577/6	154	586/4	139
457/1	69	491/4	48	514/1	137	537/6	161	566/4	189	577/7	158	586/5	139
457/2	69	491/5	48	515/1	71	537/7	161	566/5	158	577/8	158	586/6	280
458/1	32	491/6	48	515/2	71	537/8	161	566/6	158	577/9	158	586/7	280
459/1	69	491/7	50	515/3	135	537/9	161	567/1	158	577/10	158	586/8	281
460/1	70	491/8	46	515/4	135	538/1	201	567/2	158	577/11	154	586/9	281
460/2	70	491/8/D89	46	515/5	137	538/2	201	568/1	158	577/12	154	586/10	281
461/1	70	491/8/D127	46	515/6	137	539/1	201	568/2	158	578/1	149	586/11	281
462/1	147	491/8/D133	46	516/1	135	539/2	201	569/1	158	578/2	149	586/12	280
462/2	147	491/8/D140	46	516/2	135	540/1	294	569/2	158	578/3	149	586/13	280
462/3	147	491/9	47	516/3	137	540/2	80	570/1	201	578/4	149	586/14	280
462/4	147	491/10	51	517/1	191	541/1	79	570/2	201	578/5	156	586/15	280
463/1	82	491/11	51	518/1	191	541/2	79	570/3	201	578/6	156	586/16	280
463/2	82	491/12	51	518/2	191	543/1	114	570/4	201	578/7	158	586/17	280
463/3	82	491/13	47	518/3	191	543/2	114	571/1	159	578/8	158	586/18	281
463/4	82	491/14	47	519/1	191	543/3	114	571/2	159	578/9	158	586/19	281
464/1	82	491/15	47	520/1	191	543/4	114	571/3	158	578/10	158	586/20	281
464/2	82	491/16	46	520/2	191	543/5	114	571/4	158	578/11	154	587/1	281
464/3	82	491/17	46	521/1	191	543/6	114	572/1	275	578/12	154	587/2	281
464/4	82	492/1	135	522/1	191	544/1	114	572/2	275	578/13	275	587/3	281
465/1	198	492/2	135	522/2	191	544/2	114	572/3	275	578/14	275	587/4	281
466/1	198	493/1	135	522/3	191	544/3	114	572/4	275	578/15	275	587/5	281
466/2	200	493/2	135	522/4	191	545/1	114	572/5	271	578/16	275	587/6	281
467/1	200	494/1	137	522/5	191	545/2	114	572/5	275	578/17	275	587/7	281
468/1	200	494/2	137	523/1	131	545/3	114	572/6	271	578/18	275	587/8	281
468/2	200	494/3	434	523/2	131	546/1	114	572/7	271	578/19	275	587/9	281
468/3	200	496/1	137	523/3	131	546/2	114	572/7	275	578/20	275	587/10	281
468/4	200	496/2	137	523/4	131	546/3	114	572/8	271	581/1	208	587/11	281
469/1	200	496/3	137	525/1	185	547/1	114	572/13	275	581/2	208	587/12	281
470/1	200	496/B/1	137	527/1	185	547/2	114	572/14	275	581/3	208	587/13	281
471/1	119	496/B/2	137	527/2	185	547/3	114	572/15	275	581/4	208	587/14	281
471/2	71	496/B/3	137	527/3	185	548/1	114	572/16	275	581/5	208	587/15	281
471/3	43	496/B/4	137	528/1	182	548/2	114	572/17	275	581/6	208	587/16	281
472/1	117	496/B/5	137	529/1	185	549/1	114	572/18	275	581/7	208	587/17	281
472/2	200	496/C/1	127	529/2	185	549/2	114	572/19	275	581/8	208	587/18	281
472/3	200	496/C/2	127	529/3	185	550/1	114	572/20	275	581/9	208	587/19	281
473/1	117	497/1	124	529/4	185	550/2	114	573/1	149	581/10	208	587/20	281
474/1	117	497/2	124	529/5	185	550/3	114	573/2	149	581/11	208	587/21	281
475/1	109	498/1	118	529/6	191	550/4	114	573/3	149	581/12	208	587/22	281
475/2	109	498/1	294	529/7	191	551/1	114	573/4	149	582/1	75	587/23	281
476/1	109	498/2	118	529/8	185	552/1	114	573/5	159	582/2	75	587/24	281
476/2	109	498/2	294	530/1	185	553/1	114	573/6	159	582/3	75	587/25	281
477/1	109	499/1	128	530/2	185	554/1	114	573/7	149	583/1	76	587/26	281
477/2	109	499/2	128	530/3	185	555/1	114	573/8	149	583/2	75	587/27	281
478/1	109	500/1	129	530/4	185	556/1	114	573/9	149	583/3	76	587/28	281
478/2	109	500/2	129	531/1	183	557/1	114	573/10	149	583/4	76	587/29	281
478/3	373	501/1	133	531/2	384	558/1	114	574/1	344	584/1	192	587/30	281
478/4	373	501/2	129	531/3	384	560/1	191	574/2	344	584/2	192	587/31	281
478/5	373	501/3	133	531/4	384	560/2	191	574/3	344	584/3	208	587/32	281
478/6	373	502/1	136	531/5	384	560/3	191	574/4	344	584/4	192	587/33	281
479/1	118	502/2	136	533/1	185	561/1	159	574/5	344	584/5	192	587/34	281
479/2	81	503/1	132	533/2	185	561/2	159	574/6	344	584/6	192	587/35	281
479/3	118	503/2	133	533/3	185	561/3	157	574/7	344	584/7	192	587/36	281
480/1	70	504/1	190	533/4	185	561/4	157	574/8	344	584/A/1	155	587/37	281
483/1	109	504/2	123	533/5	384	561/5	156	574/9	344	584/A/2	155	587/38	281
483/2	109	504/3	123	533/6	384	561/6	156	574/10	398	584/A/3	208	587/39	281
483/3	41	505/1	135	533/7	384	562/1	159	574/11	398	584/A/4	203	587/40	281
483/4	34	505/2	135	533/8	384	562/2	159	574/12	398	584/A/5	203	587/41	138
483/5	34	505/3	133	535/1	185	563/1	189	574/13	398	584/A/6	203	587/42	138
484/1	117	505/4	133	535/2	185	563/2	189	574/14	398	584/B/1	203	587/43	138
484/2	36	507/1	136	535/3	185	563/3	189	574/15	398	584/B/2	203	587/44	138
485/1	79	507/2	136	535/4	384	563/4	189	576/1	149	584/B/3	203	587/45	138
486/1	200	508/1	133	535/5	384	564/1	189	576/2	149	584/B/4	203	587/46	138
486/2	117	508/2	123	535/6	384	564/2	189	576/3	149	584/B/5	203	587/47	138
487/1	137	508/3	130	536/1	186	564/3	189	576/4	149	584/B/6	203	587/48	138
488/1	137	508/4	130	536/2	186	564/4	189	576/5	149	585/1	148	589/1	286
489/1	136	509/1	137	536/3	186	565/1	189	576/6	149	585/2	148	589/2	286
489/2	136	510/1	113	536/4	186	565/2	189	577/1	158	585/3	148	589/3	286

INDICE - INDEX

589/4	278	599/3	260	605/8	302	617/4	188	630/3	34	648/1	294	662/3	418
589/5	279	599/4	260	606/1	298	617/5	188	630/4	36	648/2	34	662/4	418
589/6	207	599/5	260	606/2	298	617/6	188	630/5	40	648/3	38	662/5	418
591/1	277	599/6	260	606/3	298	617/7	188	630/6	40	648/4	294	662/6	418
591/2	277	599/7	260	606/4	298	620/1	316	630/7	41	650/1	27	663/1	418
591/3	277	599/8	260	607/1	298	620/2	434	630/8	41	650/2	29	663/2	418
591/4	277	599/9	260	607/2	298	620/3	434	630/9	41	650/3	29	663/3	428
593/1	380	600/1	260	607/3	298	620/4	434	630/10	40	650/4	29	663/4	428
593/2	380	600/2	260	607/4	298	621/1	316	630/11	40	651/1	29	663/5	428
593/3	380	600/3	260	608/1	314	622/1	267	630/12	40	651/2	29	663/6	428
593/4	380	600/4	260	608/2	314	622/2	267	630/13	296	651/3	29	663/7	428
593/5	380	600/5	260	608/3	314	622/3	267	633/1	41	651/4	29	663/8	428
593/6	380	600/6	260	608/4	314	622/4	267	633/2	41	653/1	350	664/1	410
593/7	380	600/7	260	608/5	306	622/5	267	634/1	294	653/2	350	664/2	410
593/8	347	600/8	260	608/6	306	622/6	267	634/2	294	653/3	350	664/3	436
593/9	347	600/9	260	608/7	306	623/1	262	634/3	34	653/4	350	664/4	428
593/10	380	600/10	260	608/8	306	623/2	262	634/4	36	653/5	351	664/5	428
593/11	380	601/1	143	609/1	405	623/3	262	634/5	36	654/1	350	664/6	428
594/1	345	601/2	143	609/2	310	623/4	262	634/6	35	654/2	351	664/7	422
594/2	346	601/3	143	609/3	310	623/5	262	634/7	36	654/3	351	664/8	437
594/3	346	601/4	143	610/4	348	623/6	262	634/8	36	654/4	351	664/9	435
594/4	346	601/5	143	610/5	348	623/7	262	635/1	39	654/5	405	665/1	421
594/5	43	601/6	143	610/6	348	623/8	262	635/2	38	654/5	351	665/2	421
595/1	142	601/7	143	610/7	348	623/9	262	635/3	39	655/1	35	665/3	421
595/2	142	601/8	143	610/8	348	623/10	262	635/4	38	655/2	37	665/4	421
595/3	142	601/9	143	610/9	348	623/11	262	636/1	296	655/3	36	665/5	421
595/4	142	601/10	143	610/10	348	623/12	262	636/2	41	655/4	32	665/6	428
595/5	347	601/11	143	610/11	348	623/13	262	636/3	41	655/5	32	666/1	424
595/6	347	601/12	143	610/12	348	625/1	262	636/4	71	656/1	120	666/2	424
595/7	345	601/13	143	610/13	348	625/2	262	636/5	43	656/2	31	666/3	424
595/8	142	601/14	143	610/14	348	625/3	262	636/6	296	656/3	31	666/4	431
595/9	142	601/15	143	610/15	348	625/4	262	638/1	51	656/4	31	666/5	431
595/10	142	601/16	143	610/16	348	625/5	262	638/2	51	657/1	32	666/6	431
595/11	142	601/17	143	610/17	348	625/6	262	638/3	51	657/2	32	666/7	431
595/12	142	601/18	143	610/18	348	625/7	262	638/4	52	657/3	32	666/8	431
595/13	142	602/1	143	610/19	348	625/8	262	638/5	51	658/1	32	666/9	431
595/14	142	602/2	143	610/20	348	625/9	262	638/6	51	658/2	32	668/1	110
595/15	142	602/3	143	610/21	348	625/10	262	639/1	295	658/3	32	668/2	110
595/16	347	602/4	143	610/22	348	626/1	266	639/2	295	658/4	32	668/3	110
595/17	347	602/5	143	610/23	348	626/2	266	639/3	295	658/5	32	668/4	110
595/18	347	602/6	143	610/24	348	626/3	266	639/4	295	658/6	30	670/1	110
595/19	347	602/7	143	610/25	348	626/4	266	639/5	225	658/7	30	670/2	110
596/1	294	602/8	143	610/26	348	626/5	266	639/5	225	658/8	30	670/3	110
596/2	294	602/9	143	610/27	348	626/6	266	639/5	142	659/1	32	670/4	110
596/3	294	602/10	143	610/28	348	626/7	266	639/6	142	659/2	32	671/1	110
596/4	34	602/11	143	610/29	348	626/8	266	641/1	24	659/3	32	671/2	110
597/1	143	602/12	143	610/30	348	626/9	266	641/2	24	659/4	32	671/3	110
597/2	143	602/13	143	610/31	348	626/10	262	641/3	24	659/5	31	671/4	110
597/3	143	602/14	143	611/1	315	626/11	262	641/4	24	659/6	30	673/1	413
597/4	143	602/15	143	611/2	315	626/12	262	641/5	24	659/7	32	673/2	413
597/5	317	602/16	143	611/3	315	626/13	262	641/6	24	659/8	32	673/3	413
598/1	260	602/17	143	611/4	315	626/14	262	641/7	24	659/9	32	675/1	415
598/2	260	602/18	143	611/5	315	626/15	262	641/8	24	659/10	30	675/2	415
598/3	260	604/1	174	611/6	315	626/16	262	642/1	294	659/11	30	675/3	415
598/4	260	604/2	174	611/7	314	626/17	266	642/2	294	660/1	434	675/4	415
598/5	260	604/3	174	611/8	314	626/19	262	642/3	34	660/2	434	675/5	415
598/6	260	604/4	434	611/9	314	628/1	38	642/4	38	660/3	434	675/6	435
598/7	260	604/5	434	611/10	314	628/2	38	645/1	43	660/4	434	675/7	435
598/8	260	604/6	174	611/11	314	628/3	38	645/2	296	660/5	434	675/8	436
598/9	260	604/7	174	611/12	314	628/4	38	645/3	37	660/6	434	675/9	436
598/10	260	604/8	174	613/1	348	628/5	40	645/4	43	660/7	434	675/10	436
598/11	260	604/9	434	613/2	348	628/6	42	645/5	292	660/8	434	675/11	436
598/12	260	604/10	434	614/4	315	629/1	40	645/6	35	660/9	431	675/12	436
598/13	260	604/11	417	614/5	315	629/2	43	645/7	39	660/10	421	675/13	436
598/14	260	604/12	417	614/6	315	629/3	40	646/1	294	660/11	421	675/14	436
598/15	260	605/1	299	615/1	188	629/4	39	646/2	294	660/12	421	675/15	436
598/16	260	605/2	299	615/2	188	629/4	296	646/3	39	661/1	418	675/16	434
598/17	260	605/3	299	615/3	188	629/5	43	646/4	34	661/2	418	675/17	434
598/18	260	605/4	299	615/4	188	629/6	41	646/5	38	661/3	412	676/1	421
598/19	260	605/5	302	617/1	188	629/7	36	646/6	38	661/4	412	676/2	428
599/1	260	605/6	302	617/2	188	630/1	38	646/7	39	662/1	418	676/3	433
599/2	260	605/7	302	617/3	188	630/2	41	646/8	38	662/2	418	678/1	120

INDICE - INDEX

678/2	120	688/1	32	697/3	410	706/13	437	710/9	429	726/15	396	737/2	371
679/1	65	688/2	41	697/4	410	706/14	509	710/10	510	726/16	396	737/3	371
679/2	65	688/2	292	697/5	365	706/15	417	710/11	429	726/17	396	737/4	371
679/3	65	688/3	41	697/7	365	706/16	509	710/12	510	726/18	399	737/5	371
680/1	65	688/3	292	697/8	365	706/17	437	710/13	429	726/19	396	737/6	371
680/2	65	688/4	40	698/1	437	706/18	509	710/14	510	726/20	330	737/7	371
681/1	111	688/5	40	698/2	437	706/19	417	711/1	414	726/21	330	737/8	371
681/2	111	688/6	40	700/1	416	706/20	509	711/2	414	726/22	330	738/1	369
681/3	111	688/7	40	700/2	416	706/21	417	711/3	414	726/23	330	738/2	369
681/4	111	688/8	32	700/3	417	706/22	509	711/4	433	727/1	386	738/3	369
681/5	111	688/9	40	700/4	416	706/23	417	711/5	433	727/2	386	738/4	369
681/6	111	689/1	426	700/5	416	706/24	509	711/6	433	727/3	386	738/5	369
681/7	111	689/2	426	700/6	417	707/1	437	711/7	429	727/4	388	738/6	369
681/8	111	689/3	426	700/7	416	707/2	509	711/8	429	727/5	388	738/7	369
682/1	111	689/4	426	700/8	417	707/3	437	711/9	429	727/6	388	738/8	369
682/2	111	689/5	426	700/9	416	707/4	509	713/1	112	727/7	387	738/9	369
682/3	111	689/6	426	700/10	416	707/5	437	713/2	112	727/8	387	738/10	369
682/4	111	689/7	419	701/1	420	707/6	509	714/1	112	727/9	387	738/11	369
682/5	111	689/8	419	701/2	437	707/7	438	715/1	112	727/10	386	739/1	363
682/6	111	689/9	419	701/3	429	707/8	509	715/2	112	727/11	386	739/2	363
682/7	111	689/10	419	701/4	423	707/9	437	716/1	112	727/12	331	739/3	363
682/8	33	690/1	434	701/5	433	707/10	509	716/2	112	727/13	331	739/4	371
682/9	33	690/2	434	701/6	423	707/11	437	716/3	112	727/14	331	739/5	371
682/10	33	690/3	434	701/7	433	707/12	509	716/4	112	727/15	331	739/6	371
682/11	33	690/4	434	701/8	433	707/13	437	717/1	296	727/16	331	741/1	364
683/1	33	691/1	419	701/9	433	707/14	509	717/2	296	727/17	331	741/2	364
683/2	33	691/2	419	701/10	407	708/1	422	717/5	422	727/18	331	741/3	364
683/3	33	691/3	434	702/1	417	708/2	509	718/1	69	727/19	331	741/4	364
683/3	111	691/4	434	702/2	417	708/3	422	719/1	65	727/20	331	741/5	364
683/4	33	691/5	50	702/3	417	708/4	509	719/2	70	727/21	331	741/6	364
683/4	111	691/6	431	704/1	431	708/5	422	720/1	65	727/22	331	741/7	364
684/1	33	691/7	431	704/2	509	708/6	509	720/2	65	727/23	331	741/8	364
684/2	33	692/1	431	704/3	431	708/7	422	720/3	425	727/24	331	742/1	372
684/3	33	692/2	436	704/4	509	708/8	510	720/4	425	727/25	331	742/2	372
684/4	33	692/3	436	704/5	431	708/9	422	722/1	391	727/26	331	742/3	372
684/5	41	692/4	436	704/6	509	708/10	510	722/2	391	727/27	331	742/4	372
684/6	50	692/5	436	704/7	431	708/11	437	722/3	325	727/28	331	742/5	372
684/7	37	692/6	436	704/8	509	708/12	510	722/3	391	727/29	331	742/6	372
685/1	111	692/7	436	704/9	431	708/13	437	722/4	325	727/30	331	743/1	504
685/2	111	692/8	415	704/10	509	708/14	510	722/4	391	727/31	331	743/2	504
685/3	111	692/9	415	704/11	431	708/15	437	722/5	324	727/32	331	743/3	505
685/4	111	692/10	431	704/12	509	708/16	510	722/5	391	727/33	331	743/4	504
685/5	111	694/1	435	705/1	432	708/17	437	722/6	324	727/34	331	743/5	504
685/6	111	694/2	435	705/2	508	708/18	510	722/6	391	727/35	331	743/6	504
685/7	111	694/3	435	705/3	432	709/1	437	722/7	391	727/36	331	743/7	504
685/8	111	694/4	435	705/4	508	709/2	510	722/8	391	727/37	331	743/8	504
686/1	33	694/5	435	705/5	432	709/3	437	723/1	399	728/1	505	743/9	504
686/2	33	694/6	435	705/6	508	709/4	510	723/2	390	731/1	397	743/10	504
686/3	33	694/7	435	705/7	432	709/5	437	723/3	390	731/2	386	744/1	503
686/4	33	694/8	435	705/8	508	709/6	510	723/4	394	731/3	397	744/2	503
686/5	33	694/9	437	705/9	432	709/7	412	723/5	394	731/4	397	744/3	503
686/6	33	694/10	434	705/10	508	709/8	510	723/6	394	731/5	397	744/4	503
686/7	33	694/11	435	705/11	433	709/9	412	724/1	394	731/6	397	744/5	503
686/8	33	694/12	435	705/12	508	709/10	510	725/1	389	731/7	397	744/6	503
686/9	33	694/13	435	705/13	433	709/11	412	725/2	388	732/1	397	744/7	503
686/10	33	695/1	424	705/14	508	709/12	510	725/3	388	732/2	397	744/8	503
686/11	33	695/2	424	705/15	433	709/13	437	725/4	389	732/3	397	745/1	373
686/12	33	695/3	424	705/16	508	709/14	510	725/5	38	733/1	397	745/2	373
686/13	33	695/4	424	705/17	433	709/15	437	726/1	399	733/2	397	745/3	373
686/14	33	695/5	424	705/18	508	709/16	510	726/2	399	733/3	397	745/4	373
686/15	33	695/6	466	706/1	417	709/17	437	726/3	394	733/4	397	745/5	373
686/16	33	695/7	466	706/2	509	709/18	510	726/4	390	733/5	397	745/6	373
686/17	40	695/8	466	706/3	417	709/19	417	726/5	396	734/1	397	745/7	373
686/18	40	695/9	466	706/4	509	709/20	510	726/6	387	734/2	397	745/8	373
687/1	32	695/10	466	706/5	417	709/21	437	726/7	387	734/3	397	745/9	373
687/2	32	695/11	466	706/6	509	709/22	510	726/8	388	735/1	397	745/10	373
687/3	33	695/12	466	706/7	437	710/1	429	726/9	388	735/2	397	745/11	373
687/4	33	696/1	354	706/8	509	710/2	510	726/10	371	735/3	397	746/1	366
687/5	33	696/2	433	706/9	437	710/3	429	726/11	371	736/1	397	746/2	366
687/6	33	696/3	425	706/10	509	710/4	510	726/12	396	736/2	397	746/3	366
687/7	33	697/1	429	706/11	437	710/7	429	726/13	396	736/3	397	746/4	366
687/8	33	697/2	429	706/12	509	710/8	510	726/14	396	737/1	371	746/5	366

INDICE - INDEX

746/6	366	755/3	181	771/5	537	781/8	515	793/8	511	810/3	235	811/4/T	249
747/1	367	755/4	181	771/6	536	781/9	515	793/9	511	810/4	235	811/5	237
747/2	367	755/5	162	771/7	536	781/10	515	793/10	511	810/5	235	811/5/T	242
747/3	366	755/6	162	771/8	536	781/11	515	795/1	511	810/7/C	235	811/6	237
747/4	367	756/1	57	771/9	536	782/1	515	795/2	511	810/8/C	235	811/6/T	239
747/5	367	756/2	420	771/10	536	782/2	515	795/3	511	810/10	235	811/7	237
747/6	367	756/3	57	771/11	536	782/3	515	795/4	511	810/11	235	811/7/T	249
747/7	367	756/4	420	771/12	536	782/4	515	795/5	511	810/12	235	811/8	237
747/8	367	756/5	57	771/13	536	782/5	515	795/6	505	810/13	235	811/8/T	242
747/9	367	756/6	438	771/14	536	783/1	518	795/7	505	810/A/1	235	811/9/T	248
747/10	367	756/7	57	772/1	533	783/2	518	795/8	505	810/A/2	235	811/10/T	248
747/11	367	756/8	438	772/2	533	783/3	518	795/9	505	810/A/3	235	812/1	235
747/12	360	756/9	438	772/3	535	783/4	518	795/10	505	810/A/4	235	812/2	235
747/13	360	756/10	57	772/4	535	783/5	518	795/11	505	810/A/5	235	812/3	235
747/14	360	756/10	437	772/5	535	783/6	518	795/12	505	810/A/6	235	812/4	235
747/15	361	756/11	57	772/6	535	783/7	518	796/1	505	810/A/7	235	812/5	235
747/16	361	756/12	420	772/7	535	783/8	518	796/2	505	810/A/9	235	812/6	235
747/17	361	756/13	420	772/8	523	783/9	518	796/3	505	810/A/10	235	812/7	235
747/18	360	756/14	420	772/9	523	783/10	518	796/4	505	810/A/11	235	812/8	235
747/19	360	756/15	438	772/10	523	783/11	518	796/5	505	810/A/12	235	812/9	243
747/20	360	756/16	438	772/11	523	783/12	518	796/6	505	810/A/13	235	812/10	243
747/21	361	756/17	438	772/12	523	784/1	518	796/7	505	810/A/14	235	812/11	243
747/22	361	757/3	57	772/13	523	784/2	518	797/1	227	810/A/15	235	812/12	237
747/23	361	757/4	438	772/14	523	784/3	518	797/2	223	810/A/16	235	812/12/T	239
749/1	402	757/5	420	772/15	523	784/4	518	797/3	228	810/A/18	235	812/13	237
749/2	402	767/1	524	772/16	530	784/5	518	797/4	223	810/A/19	251	812/13/T	249
749/3	380	767/2	524	772/17	530	785/5	518	797/5	227	810/A/19/T	251	812/15	237
749/4	378	767/3	524	774/7	517	785/6	518	797/6	223	810/A/20	251	812/15/T	242
749/5	378	768/1	521	774/8	517	785/7	518	797/7	223	810/A/20/T	251	815/1	506
749/6	378	768/2	521	774/9	517	785/8	518	798/1	227	810/A/21	251	815/2	506
749/7	378	768/3	526	774/10	517	785/11	518	798/2	227	810/A/22	251	815/3	506
749/8	378	768/4	526	774/11	517	785/12	518	799/1	227	810/A/23	235	816/1	506
749/9	378	768/5	526	774/12	517	785/13	518	799/2	227	810/A/24	235	816/2	507
749/10	378	768/6	525	774/13	516	786/1	516	799/3	223	810/B/1	248	816/3	506
749/11	378	768/7	526	776/1	516	786/2	516	800/1	223	810/B/1/T	242	816/4	506
749/12	378	768/8	526	776/2	516	786/3	516	800/2	222	810/B/2	248	816/5	506
749/13	378	768/9	526	776/3	516	789/1	510	800/3	227	810/B/2/T	242	816/6	507
749/14	378	768/10	530	779/1	516	789/2	510	800/4	227	810/B/3	248	816/7	507
749/15	378	768/11	526	779/2	516	789/3	510	801/1	229	810/B/3/T	242	816/8	507
749/16	378	768/12	526	779/3	516	789/4	510	801/2	229	810/B/4	248	816/9	507
749/17	378	769/1	526	779/4	516	789/5	510	801/3	226	810/B/4/T	242	816/10	507
749/18	378	769/2	527	779/5	516	789/6	510	801/4	226	810/B/5	248	816/11	507
749/19	378	769/3	525	779/6	516	789/7	510	801/5	229	810/B/5/T	242	816/12	507
749/20	378	769/4	525	780/1	515	789/8	510	801/6	222	810/B/6	248	816/13	507
749/21	378	769/5	526	780/2	515	789/9	510	801/7	229	810/B/6/T	242	816/14	507
749/22	402	769/6	526	780/3	515	789/10	510	801/8	229	810/B/7	248	816/15	507
750/1	428	769/7	527	780/4	515	790/1	511	802/1	228	810/B/7/T	242	816/16	507
750/2	424	769/8	527	780/5	515	790/2	511	802/2	228	810/B/8	248	817/1	507
750/3	428	769/9	528	780/6	515	790/3	71	802/3	227	810/B/8/T	242	817/2	507
751/1	428	769/10	528	780/7	515	790/4	511	802/4	406	810/B/13	241	817/3	507
751/2	429	769/11	530	780/8	515	790/5	502	802/5	406	810/B/13/T	240	817/4	507
751/3	429	769/12	525	780/9	515	790/6	502	803/1	516	810/B/14	241	818/1	507
751/4	398	769/13	528	780/10	515	790/7	496	803/2	516	810/B/14/T	240	818/2	507
751/5	428	770/1	522	780/11	515	790/8	496	803/3	516	810/B/15	241	818/3	507
751/6	398	770/2	522	780/12	515	790/9	496	803/4	505	810/B/15/T	240	818/4	507
751/7	398	770/3	522	780/13	515	790/10	496	803/5	505	810/B/16	241	819/1	404
751/8	398	770/4	522	780/14	515	791/1	511	804/1	232	810/B/16/T	240	819/2	404
751/9	398	770/5	522	780/15	515	791/2	511	804/2	232	810/B/17	241	819/3	404
753/1	76	770/6	520	780/16	515	791/3	511	805/1	232	810/B/17/T	240	819/4	404
753/2	76	770/7	520	780/17	515	791/4	511	805/2	232	810/B/18	241	819/5	404
753/3	76	770/8	520	780/18	515	791/5	511	806/1	232	810/B/18/T	240	819/6	404
753/4	76	770/9	520	780/19	515	791/6	511	806/2	232	810/B/19	243	819/7	404
753/5	76	770/10	520	780/20	515	791/7	511	806/3	232	810/B/19/T	240	819/8	404
753/6	76	770/11	522	780/21	515	791/8	511	806/4	232	810/B/20	243	819/9	404
753/7	76	770/12	522	780/22	515	791/9	511	806/5	232	810/B/20/T	240	819/10	404
753/8	76	770/13	520	781/1	515	793/1	511	806/6	232	810/B/21	241	819/11	404
753/9	76	770/14	521	781/2	515	793/2	511	807/1	232	810/B/22	241	819/12	383
754/1	203	770/15	520	781/3	515	793/3	511	807/2	232	811/1	243	819/13	383
754/2	203	771/1	537	781/4	515	793/4	511	807/3	232	811/2	236	819/14	383
754/3	203	771/2	537	781/5	515	793/5	511	807/4	232	811/3	237	819/15	404
755/1	203	771/3	536	781/6	515	793/6	511	810/1	235	811/3/T	239	819/16	404
755/2	181	771/4	537	781/7	515	793/7	511	810/2	235	811/4	237	819/17	404

INDICE - INDEX

819/18	404	837/10	454	844/34	457	850/17	473	870/2	460	881/3	464	891/1	477
830/1	455	838/1	448	845/1	458	850/18	473	870/3	460	881/4	464	891/2	477
830/2	455	838/2	448	845/2	458	850/19	473	870/4	460	881/5	464	891/3	477
830/3	455	838/3	448	845/3	458	850/20	473	871/1	460	881/6	464	891/4	477
830/4	455	838/4	448	845/4	458	850/21	473	872/1	460	881/7	464	891/5	477
830/5	455	838/5	492	845/5	458	850/22	473	872/2	460	881/8	464	891/6	477
830/6	455	838/6	492	845/6	458	850/23	473	872/3	460	881/9	464	892/1	477
830/7	455	838/7	492	845/7	458	850/24	473	872/4	460	882/1	464	892/2	477
830/8	455	839/1	452	845/8	459	850/25	473	872/5	460	882/2	464	892/3	477
830/9	455	839/2	452	845/9	459	850/26	473	872/6	460	882/3	464	892/4	477
830/10	455	839/3	452	845/10	459	850/27	473	872/7	460	882/4	465	892/5	477
830/11	455	839/4	452	845/11	459	850/28	473	872/8	460	883/1	464	892/6	477
830/12	455	839/5	449	845/12	459	850/29	473	872/9	460	883/3	464	902/4	491
830/13	455	839/6	449	845/13	459	850/30	473	872/10	460	883/4	464	902/6	491
830/14	455	839/7	449	845/14	459	850/31	473	872/11	460	885/1	490	938/1	596
830/15	455	839/8	449	845/15	459	850/32	473	873/1	460	885/2	490	939/1	597
830/16	455	839/9	449	845/16	459	850/33	473	873/2	460	885/3	490	1009/1	59
830/17	455	839/10	449	845/17	457	850/34	473	873/3	460	885/4	490	1009/2	59
830/18	455	840/1	454	845/18	458	850/35	473	874/1	461	885/5	490	1010/1	59
830/19	455	840/2	454	845/19	458	850/36	473	874/2	461	885/6	490	1010/2	68
830/20	455	840/3	454	845/20	458	850/37	473	874/3	461	885/7	490	1010/3	59
830/21	455	840/4	454	845/21	458	850/38	473	874/4	461	885/8	490	1011/1	67
831/1	445	840/5	454	845/22	458	850/39	473	874/5	461	886/1	490	1011/2	67
832/1	450	840/6	454	845/23	458	850/40	473	875/1	461	886/2	490	1011/3	69
832/2	450	841/1	443	845/24	458	850/41	473	875/2	461	886/3	490	1012/1	62
832/3	450	841/2	443	845/25	458	850/42	473	875/3	461	886/4	490	1012/2	69
832/4/DX	450	841/3	443	845/26	459	850/43	473	875/4	461	887/1	43	1013/1	60
832/4/SX	450	841/4	443	845/27	459	850/44	473	875/5	461	888/1	43	1013/2	60
832/5	450	841/5	443	845/28	459	850/45	473	875/6	461	888/2	492	1014/1	60
832/6	450	841/6	443	845/29	459	850/46	473	875/7	461	888/3	492	1014/2	60
832/7	450	841/7	407	845/30	459	850/47	473	875/8	461	889/1	489	1014/3	69
832/8	450	842/1	443	846/4	457	850/48	473	875/9	461	889/2	489	1015/1	69
833/1	452	842/2	443	846/5	459	850/49	473	875/10	461	889/3	489	1015/2	60
833/2	452	842/3	443	846/6	458	850/50	473	875/11	461	889/4	489	1017/1	68
833/3	452	842/4	443	846/7	458	850/51	473	875/12	461	889/5	489	1017/2	68
833/4	445	842/5	443	846/8	458	850/52	473	876/1	462	889/6	489	1017/3	59
833/5	450	842/6	443	846/9	458	851/1	473	876/2	462	889/7	489	1017/4	59
833/6	452	842/7	443	846/10	458	851/2	473	876/3	462	889/8	489	1019/1	70
833/7	450	842/8	443	846/11	458	851/3	473	876/4	462	889/9	489	1019/2	70
833/8	450	844/1	457	846/12	458	851/4	473	876/5	462	889/10	489	1019/3	70
833/9	450	844/2	457	846/13	458	851/5	473	876/6	461	889/11	489	1019/4	70
834/1	448	844/3	457	846/14	458	851/6	473	876/7	461	889/12	489	1019/5	70
834/2	448	844/4	457	846/15	458	851/7	473	876/8	461	889/13	489	1019/6	70
834/3	452	844/5	457	846/16	458	851/8	473	876/9	461	889/14	489	1019/7	70
835/1	453	844/6	457	846/17	458	851/9	473	876/10	461	889/15	489	1019/8	70
835/2	453	844/7	457	846/18	459	851/10	473	876/11	461	889/16	489	1019/9	70
835/3	453	844/8	457	846/19	459	851/11	473	877/1	462	889/17	489	1020/1	63
835/4	453	844/9	457	846/20	459	851/12	473	877/2	462	889/18	489	1021/1	63
835/5	453	844/10	457	846/21	459	851/13	473	877/3	462	889/19	489	1022/1	63
835/6	444	844/11	457	846/22	459	851/14	473	877/4	462	889/20	489	1023/1	63
835/7	445	844/12	457	848/1	474	851/15	473	877/5	462	889/21	489	1024/1	70
835/8	445	844/13	457	848/2	474	851/16	473	877/6	462	889/22	489	1025/1	70
835/9	445	844/14	457	849/1	474	851/17	473	877/7	462	889/23	489	1026/1	70
836/1	445	844/15	457	849/2	474	851/18	473	877/8	462	889/24	489	1027/1	70
836/2	450	844/16	457	849/3	474	852/1	473	878/1	462	889/25	489	1028/1	62
836/3	450	844/17	457	849/4	474	852/2	473	878/2	462	889/26	489	1028/2	62
836/4	452	844/18	457	850/1	473	852/3	373	878/3	462	889/27	489	1032/1	115
836/5	450	844/19	457	850/2	473	852/4	469	878/4	462	889/28	489	1032/2	115
836/6	450	844/20	457	850/3	473	852/5	469	878/5	462	889/29	489	1033/1	115
836/7	451	844/21	457	850/4	473	852/6	469	878/6	462	889/30	489	1033/2	115
836/8	451	844/22	457	850/5	473	852/7	469	878/7	462	889/31	489	1034/1	115
836/9	451	844/23	457	850/6	473	852/8	469	878/8	462	889/32	489	1034/2	115
837/1	453	844/24	457	850/7	473	852/9	469	879/1	462	889/33	489	1035/1	115
837/2	453	844/25	457	850/8	473	852/10	469	879/2	462	889/34	489	1035/2	115
837/3	453	844/26	457	850/9	473	852/11	469	879/3	462	889/35	489	1038/1	109
837/4	454	844/27	457	850/10	473	852/12	469	880/1	464	889/36	489	1038/2	109
837/5	454	844/28	457	850/11	473	852/13	469	880/2	464	889/37	489	1038/3	41
837/6/DX	454	844/29	457	850/12	473	852/14	469	880/3	464	889/38	489	1039/1	109
837/6/SX	454	844/30	457	850/13	473	852/15	469	880/4	464	889/39	489	1039/2	36
837/7	454	844/31	457	850/14	473	869/1	460	880/5	464	889/40	489	1039/3	40
837/8	454	844/32	457	850/15	473	869/2	460	881/1	464	889/41	489	1040/1	109
837/9	454	844/33	457	850/16	473	870/1	460	881/2	464	889/42	489	1043/1	113

INDICE - INDEX

1043/2	113	1069/3	148	1106/1	115	1132/9	143	1141/2	206	1149/5	147	1163/4	374
1045/5	88	1069/4	148	1107/1	115	1133/1	346	1142/1	113	1149/5/GR	147	1163/5	374
1045/6	88	1071/1	204	1109/1	115	1133/2	346	1142/2	113	1149/6	147	1163/6	374
1045/7	88	1071/2	204	1111/1	114	1133/3	346	1143/1	26	1149/6/GR	147	1163/7	374
1045/8	88	1071/3	204	1111/2	114	1133/4	346	1143/2	26	1149/7	232	1163/8	374
1046/1	113	1071/4	204	1111/3	114	1133/5	346	1143/3	26	1149/7/GR	232	1163/9	375
1046/2	113	1071/5	204	1112/1	114	1133/6	346	1144/1	26	1149/8	232	1163/10	375
1046/3	20	1073/1	194	1112/2	114	1133/7	346	1144/2	26	1149/8/GR	232	1163/11	375
1046/4	20	1073/2	194	1112/3	114	1133/8	346	1144/3	26	1150/1	146	1163/12	375
1046/5	20	1073/3	204	1113/1	114	1133/9	346	1144/4	26	1150/2	146	1164/1	375
1046/6	20	1074/1	204	1113/2	114	1133/10	346	1144/5	26	1150/3	146	1164/2	375
1046/7	20	1074/2	204	1113/3	114	1133/11	346	1144/6	26	1150/4	146	1164/3	375
1049/1	175	1075/1	204	1114/1	114	1133/12	346	1145/1	26	1150/5	146	1164/4	375
1050/1	80	1075/2	204	1114/2	114	1133/13	346	1145/2	26	1150/6	146	1164/5	375
1050/2	80	1080/3	116	1114/3	114	1133/14	346	1145/3	26	1150/7	146	1165/1	379
1050/3	80	1080/4	116	1115/1	190	1133/15	346	1146/1	296	1150/8	146	1165/2	379
1050/4	80	1080/5	116	1115/2	190	1133/16	346	1146/2	296	1151/1	1445	1165/3	379
1051/1	203	1080/6	116	1115/3	116	1133/17	346	1146/3	296	1151/2	145	1165/4	379
1051/2	175	1080/7	116	1116/1	115	1133/18	346	1146/4	296	1151/3	145	1165/5	379
1051/3	175	1080/8	116	1116/2	115	1133/19	346	1146/5	296	1151/4	145	1165/6	379
1051/4	8	1080/9	329	1116/3	115	1133/20	346	1147/1	296	1151/5	140	1166/1	144
1051/5	81	1080/10	329	1116/4	115	1133/21	346	1147/2	296	1151/6	140	1166/2	144
1053/1	203	1081/1	116	1117/1	115	1133/22	346	1147/3	296	1151/7	140	1166/3	144
1053/2	34	1081/2	116	1117/2	115	1133/23	346	1147/4	296	1152/1	146	1166/4	144
1053/3	34	1081/3	116	1117/3	115	1133/24	346	1147/5	296	1152/2	146	1167/1	144
1054/1	202	1081/4	116	1118/1	115	1133/25	143	1148/1	140	1152/3	146	1167/2	144
1054/2	202	1082/1	204	1118/2	115	1133/26	143	1148/2	140	1152/4	146	1167/3	144
1054/3	202	1082/2	204	1118/3	115	1133/27	143	1148/3	140	1157/1	143	1167/4	144
1054/4	202	1082/3	204	1118/4	115	1133/28	143	1148/4	140	1157/2	149	1170/1	173
1054/5	202	1082/4	204	1120/1	83	1133/29	143	1148/5	140	1157/3	149	1170/2	173
1054/6	202	1084/1	204	1122/1	205	1133/30	143	1148/6	140	1157/4	158	1170/3	173
1055/1	202	1084/2	204	1122/2	205	1133/31	143	1148/7	140	1157/5	156	1170/4	173
1055/2	202	1084/3	204	1122/3	205	1133/32	143	1148/8	140	1157/6	185	1170/5	173
1055/3	195	1084/4	204	1122/4	205	1135/1	156	1148/9	140	1157/7	186	1170/6	173
1055/4	195	1085/1	189	1122/5	205	1135/2	156	1148/10	140	1157/8	186	1171/1	173
1055/5	202	1085/2	189	1122/6	37	1135/3	149	1148/11	140	1158/1	147	1171/2	173
1055/6	202	1086/1	189	1122/7	71	1135/4	149	1148/12	140	1158/2	147	1172/1	181
1056/1	202	1086/2	189	1124/1	205	1136/1	158	1148/13	140	1158/3	147	1172/2	181
1056/2	202	1087/1	189	1124/2	205	1136/2	159	1148/14	140	1158/4	147	1172/3	181
1056/3	202	1087/2	189	1124/3	205	1136/3	157	1148/15	140	1158/5	270	1173/1	181
1056/4	195	1088/1	189	1124/4	205	1136/4	159	1148/16	140	1158/6	271	1173/2	181
1056/4	202	1088/2	189	1125/1	205	1136/5	149	1148/17	140	1158/8	273	1173/3	181
1058/1	202	1089/1	204	1125/2	205	1136/6	149	1148/18	140	1158/9	162	1175/1	162
1058/2	202	1089/2	204	1126/1	205	1136/7	157	1148/19	140	1158/10	162	1175/2	162
1060/1	194	1089/3	205	1126/2	205	1136/8	159	1148/20	140	1158/11	148	1175/3	162
1060/2	194	1089/4	205	1127/1	193	1136/9	149	1148/21	140	1159/1	128	1175/4	162
1060/3	194	1090/1	190	1127/2	193	1136/10	149	1148/22	140	1159/2	128	1176/1	163
1060/4	194	1090/2	190	1127/3	205	1137/1	149	1148/23	140	1159/3	125	1176/2	163
1061/1	194	1090/3	190	1127/4	205	1137/2	149	1148/24	140	1159/4	125	1176/3	163
1061/2	194	1090/4	190	1127/5	205	1137/3	149	1148/25	140	1159/5	122	1176/4	163
1064/1	194	1091/1	190	1128/1	205	1137/4	149	1148/26	140	1159/6	122	1177/1	162
1064/2	194	1091/2	190	1128/2	206	1137/5	158	1148/27	140	1159/7	127	1177/2	162
1064/3	194	1092/1	190	1128/3	206	1137/6	158	1148/28	140	1159/8	127	1177/3	162
1064/4	194	1092/2	190	1128/4	206	1137/7	275	1148/28	339	1159/9	155	1177/4	162
1064/5	194	1093/1	190	1128/5	206	1137/8	275	1148/29	140	1159/10	155	1177/5	162
1064/6	194	1093/2	190	1130/1	194	1137/9	275	1148/29	339	1159/11	148	1177/6	162
1066/1	192	1094/1	190	1130/2	194	1137/10	275	1148/30	140	1159/12	148	1177/7	162
1066/2	192	1094/2	190	1130/3	195	1137/11	274	1148/30	339	1160/1	181	1177/8	162
1066/3	202	1097/1	115	1130/4	195	1137/12	274	1148/31	140	1160/2	181	1177/9	182
1066/4	202	1097/2	115	1130/5	195	1137/13	274	1148/31	339	1160/3	174	1177/10	182
1066/5	202	1097/3	180	1130/6	195	1137/14	274	1148/32	140	1160/4	174	1177/11	182
1066/6	155	1098/1	115	1131/1	206	1138/1	193	1148/32	339	1160/5	155	1177/12	182
1067/1	160	1098/2	115	1131/2	206	1138/2	193	1148/33	140	1160/6	206	1179/1	162
1067/2	160	1099/1	115	1131/3	206	1138/3	159	1148/33	339	1160/7	142	1179/2	162
1067/3	192	1099/2	115	1132/1	143	1138/4	159	1149/1	147	1160/8	142	1179/3	162
1067/4	192	1100/1	115	1132/2	143	1138/5	154	1149/1/GR	147	1160/9	143	1179/4	162
1068/1	192	1100/2	115	1132/3	143	1138/6	154	1149/2	147	1160/10	143	1179/5	191
1068/2	192	1101/1	115	1132/4	143	1138/7	155	1149/2/GR	147	1160/11	123	1179/6	191
1068/3	192	1102/1	115	1132/5	143	1138/8	155	1149/3	147	1160/12	123	1179/7	191
1068/4	192	1103/1	115	1132/6	143	1138/9	155	1149/3/GR	147	1163/1	374	1179/8	191
1069/1	192	1104/1	115	1132/7	143	1138/10	155	1149/4	147	1163/2	374	1184/1	135
1069/2	192	1105/1	115	1132/8	143	1141/1	206	1149/4/GR	147	1163/3	374	1184/1	346

1184/2	135	1211/3	182	1243/3	371	1253/4	342	1259/2	337	1260/50	325	1261/50	323
1184/2	346	1211/4	182	1243/4	371	1253/5	342	1259/3	337	1260/51	325	1261/51	323
1184/3	130	1211/5	182	1243/5	371	1253/6	342	1259/4	337	1260/52	325	1261/52	323
1184/4	123	1212/1	34	1243/6	371	1253/7	342	1259/5	337	1260/53	325	1261/53	323
1184/5	128	1212/2	39	1243/7	371	1253/8	342	1259/6	337	1260/54	325	1261/54	323
1184/6	127	1212/3	37	1243/8	371	1253/9	342	1259/7	337	1260/55	325	1261/55	323
1185/1	124	1212/4	37	1243/9	371	1253/10	342	1259/8	337	1260/56	325	1261/56	323
1185/2	129	1213/1	294	1243/10	371	1253/11	342	1259/9	337	1260/57	325	1261/57	323
1185/3	132	1213/2	294	1243/11	371	1253/12	342	1259/10	337	1260/58	325	1261/58	323
1185/4	123	1213/3	294	1243/12	371	1253/13	342	1259/11	337	1260/59	325	1261/59	323
1185/5	123	1214/1	384	1244/1	372	1253/14	342	1259/12	337	1260/60	325	1261/60	323
1187/1	127	1214/2	384	1244/2	372	1253/15	342	1259/13	337	1260/61	325	1261/61	323
1187/2	127	1214/3	384	1244/3	372	1253/16	342	1259/14	337	1260/62	325	1261/62	323
1187/3	126	1214/4	384	1244/4	372	1253/17	342	1259/15	337	1260/63	325	1261/63	323
1187/4	123	1215/1	131	1244/5	372	1253/18	342	1259/16	337	1260/64	325	1261/64	323
1189/1	125	1215/2	131	1244/6	372	1253/19	342	1259/17	337	1260/65	325	1261/65	323
1189/2	125	1215/3	131	1244/7	372	1253/20	342	1259/18	337	1260/66	325	1261/66	323
1189/3	125	1215/4	131	1244/8	372	1254/1	339	1259/19	337	1260/67	325	1261/67	323
1189/4	125	1218/1	135	1244/9	372	1254/2	339	1259/20	337	1260/68	325	1261/68	323
1190/1	134	1218/2	131	1244/10	372	1254/3	339	1259/21	337	1260/69	325	1261/69	323
1190/2	134	1218/3	384	1244/11	372	1254/4	339	1259/22	337	1260/70	325	1261/70	323
1190/3	134	1218/4	384	1244/12	372	1254/5	339	1259/23	337	1260/71	325	1261/71	323
1190/4	134	1218/5	384	1244/13	372	1254/6	339	1259/24	337	1260/72	325	1261/72	323
1191/1	134	1223/1	161	1244/14	372	1254/7	339	1260/1	327	1261/1	327	1262/1	325
1191/2	134	1223/2	161	1244/15	372	1254/8	339	1260/2	327	1261/2	327	1262/2	325
1191/3	134	1223/3	161	1244/16	372	1254/9	339	1260/3	327	1261/3	327	1262/3	325
1191/4	134	1223/4	183	1244/17	372	1254/10	339	1260/4	327	1261/4	327	1262/4	325
1192/1	132	1223/5	183	1244/18	372	1254/11	339	1260/5	327	1261/5	327	1262/5	325
1192/2	132	1229/1	187	1244/19	372	1254/12	339	1260/6	327	1261/6	327	1262/6	325
1192/3	132	1229/2	187	1244/20	372	1254/13	339	1260/7	327	1261/7	327	1262/7	325
1192/4	132	1229/3	187	1244/21	372	1254/14	339	1260/8	327	1261/8	327	1262/8	325
1192/5	129	1229/4	187	1244/22	372	1254/15	339	1260/9	327	1261/9	327	1262/9	325
1192/6	129	1229/5	187	1244/23	372	1254/16	339	1260/10	327	1261/10	327	1262/10	325
1192/7	123	1229/6	187	1246/1	231	1254/17	339	1260/11	327	1261/11	327	1262/11	325
1192/8	136	1229/7	187	1246/2	231	1254/18	339	1260/12	327	1261/12	327	1262/12	325
1192/9	136	1229/8	187	1247/1	231	1254/19	339	1260/13	327	1261/13	327	1262/13	324
1198/1	228	1230/1	187	1247/2	231	1254/20	339	1260/14	327	1261/14	327	1262/14	324
1198/2	228	1230/2	187	1251/1	138	1254/21	339	1260/15	327	1261/15	327	1262/15	324
1198/3	136	1230/3	187	1251/2	138	1254/22	339	1260/16	327	1261/16	327	1262/16	324
1198/4	136	1230/4	187	1251/3	138	1254/23	339	1260/17	327	1261/17	327	1262/17	324
1198/5	136	1231/1	187	1251/4	138	1254/24	339	1260/18	327	1261/18	327	1262/18	324
1198/6	136	1231/2	187	1251/5	138	1256/1	345	1260/19	324	1261/19	322	1262/19	324
1198/7	183	1231/3	187	1251/6	138	1256/2	345	1260/20	324	1261/20	322	1262/20	324
1198/8	183	1231/4	187	1251/7	138	1256/3	345	1260/21	324	1261/21	322	1262/21	324
1199/1	228	1233/1	187	1251/8	138	1256/4	345	1260/22	324	1261/22	322	1262/22	324
1199/2	228	1233/2	187	1251/9	138	1256/5	347	1260/23	324	1261/23	322	1262/23	324
1199/3	228	1233/3	187	1251/10	138	1256/6	347	1260/24	324	1261/24	322	1262/24	324
1199/4	228	1233/4	187	1251/11	138	1258/1	337	1260/25	324	1261/25	322	1262/25	323
1199/5	228	1234/1	187	1251/12	138	1258/2	337	1260/26	324	1261/26	322	1262/26	323
1203/1	226	1234/2	187	1252/1	342	1258/3	337	1260/27	324	1261/27	322	1262/27	323
1203/2	226	1234/3	187	1252/2	342	1258/4	337	1260/28	324	1261/28	322	1262/28	323
1204/1	226	1235/1	189	1252/3	342	1258/5	337	1260/29	324	1261/29	322	1262/29	323
1205/1	229	1236/1	189	1252/4	342	1258/6	337	1260/30	324	1261/30	322	1262/30	323
1205/2	229	1237/1	189	1252/5	342	1258/7	337	1260/31	324	1261/31	322	1262/31	323
1206/1	228	1238/1	189	1252/6	342	1258/8	337	1260/32	324	1261/32	322	1262/32	323
1207/1	231	1239/1	189	1252/7	342	1258/9	337	1260/33	324	1261/33	322	1262/33	323
1207/2	231	1239/2	189	1252/8	342	1258/10	337	1260/34	324	1261/34	322	1262/34	323
1207/3	231	1239/3	189	1252/9	342	1258/11	337	1260/35	324	1261/35	322	1262/35	323
1207/4	231	1241/1	183	1252/10	342	1258/12	337	1260/36	324	1261/36	322	1262/36	323
1208/1	184	1241/2	183	1252/11	342	1258/13	337	1260/37	325	1261/37	323	1262/37	322
1208/2	184	1241/3	183	1252/12	342	1258/14	337	1260/38	325	1261/38	323	1262/38	322
1208/3	184	1241/4	183	1252/13	342	1258/15	337	1260/39	325	1261/39	323	1262/39	322
1208/4	184	1241/5	183	1252/14	342	1258/16	337	1260/40	325	1261/40	323	1262/40	322
1208/5	183	1241/6	183	1252/15	342	1258/17	337	1260/41	325	1261/41	323	1262/41	322
1210/1	184	1242/1	183	1252/16	342	1258/18	337	1260/42	325	1261/42	323	1262/42	322
1210/2	184	1242/2	183	1252/17	342	1258/19	337	1260/43	325	1261/43	323	1262/43	322
1210/3	184	1242/3	183	1252/18	342	1258/20	337	1260/44	325	1261/44	323	1262/44	322
1210/4	184	1242/4	183	1252/19	342	1258/21	337	1260/45	325	1261/45	323	1262/45	322
1210/5	184	1242/5	183	1252/20	342	1258/22	337	1260/46	325	1261/46	323	1262/46	322
1210/6	184	1242/6	183	1253/1	342	1258/23	337	1260/47	325	1261/47	323	1262/47	322
1211/1	182	1243/1	371	1253/2	342	1258/24	337	1260/48	325	1261/48	323	1262/48	322
1211/2	182	1243/2	371	1253/3	342	1259/1	337	1260/49	325	1261/49	323	1263/1	325

INDICE - INDEX

1263/2	325	1265/36	282	1267/54	282	1270/4	286	1273/32	286	1294/7	21	1301/9	22
1263/3	325	1265/37	285	1268/1	285	1270/5	286	1273/33	286	1294/8	21	1301/10	22
1263/4	325	1265/38	285	1268/2	285	1270/6	286	1273/34	286	1294/9	21	1301/11	43
1263/5	325	1265/39	285	1268/3	285	1270/7	286	1273/35	286	1295/1	21	1301/12	38
1263/6	325	1265/40	285	1268/4	285	1270/8	286	1273/36	286	1295/2	21	1301/13	38
1263/7	325	1265/41	285	1268/5	285	1270/9	286	1273/37	286	1295/3	21	1301/14	42
1263/8	325	1265/42	285	1268/6	285	1270/10	286	1273/38	286	1295/4	21	1301/15	42
1263/9	325	1265/43	285	1268/7	285	1270/11	286	1273/39	286	1295/5	21	1301/16	42
1263/10	325	1265/44	285	1268/8	285	1270/12	286	1273/40	286	1295/6	21	1301/17	42
1263/11	325	1265/45	285	1268/9	285	1270/13	286	1273/41	286	1295/7	21	1302/1	42
1263/12	325	1265/46	285	1268/10	285	1270/14	286	1273/42	286	1296/1	23	1302/2	42
1263/13	324	1265/47	282	1268/11	282	1270/15	286	1274/1	285	1296/2	23	1302/3	35
1263/14	324	1265/48	282	1268/12	282	1270/16	286	1274/2	285	1296/3	23	1302/4	41
1263/15	324	1265/49	282	1268/13	282	1270/17	286	1274/3	285	1296/4	23	1302/5	41
1263/16	324	1265/50	282	1268/14	282	1270/18	286	1274/4	285	1296/5	23	1303/1	207
1263/17	324	1265/51	282	1268/15	282	1270/19	286	1274/5	285	1296/6	23	1303/2	207
1263/18	324	1265/52	282	1268/16	282	1270/20	286	1274/6	285	1296/7	23	1303/3	207
1263/19	324	1265/53	282	1268/17	282	1270/21	286	1275/1	280	1296/8	23	1303/4	117
1263/20	324	1265/54	282	1268/18	282	1270/22	286	1275/2	43	1296/9	23	1303/4	207
1263/21	324	1267/1	285	1268/19	285	1270/23	286	1275/2	293	1296/10	23	1303/5	117
1263/22	324	1267/2	285	1268/20	285	1270/24	286	1275/3	280	1296/11	23	1303/5	207
1263/23	324	1267/3	285	1268/21	285	1270/25	286	1275/4	41	1296/12	23	1303/6	117
1263/24	324	1267/4	285	1268/22	285	1270/26	286	1275/4	293	1296/13	23	1303/6	207
1263/25	323	1267/5	285	1268/23	285	1270/27	286	1276/1	279	1297/1	25	1303/7	35
1263/26	323	1267/6	285	1268/24	285	1270/28	286	1279/1	429	1297/2	25	1304/1	43
1263/27	322	1267/7	285	1268/25	285	1270/29	286	1279/2	429	1297/3	25	1308/1	44
1263/28	322	1267/8	285	1268/26	285	1270/30	286	1279/3	355	1297/4	25	1308/1	270
1263/29	322	1267/9	285	1268/27	285	1270/31	286	1279/4	355	1297/5	25	1308/2	44
1263/30	322	1267/10	285	1268/28	285	1270/32	286	1280/1	355	1297/6	25	1308/2	270
1263/31	322	1267/11	282	1268/29	282	1270/33	286	1280/2	356	1297/7	25	1308/3	44
1263/32	322	1267/12	282	1268/30	282	1270/34	286	1280/3	356	1297/8	25	1308/3	270
1264/1	285	1267/13	282	1268/31	282	1270/35	286	1281/1	353	1297/9	25	1308/4	44
1264/2	285	1267/14	282	1268/32	282	1270/36	286	1281/2	353	1297/10	25	1308/4	270
1264/3	285	1267/15	282	1268/33	282	1271/1	283	1281/3	355	1297/11	25	1308/5	44
1264/4	285	1267/16	282	1268/34	282	1271/2	283	1281/4	355	1297/12	25	1308/6	44
1264/5	285	1267/17	282	1268/35	282	1271/3	283	1281/5	357	1297/13	25	1308/7	44
1264/6	286	1267/18	282	1268/36	282	1271/4	283	1281/6	357	1297/14	25	1308/7	270
1265/1	285	1267/19	285	1268/37	285	1271/5	283	1281/7	356	1297/15	37	1308/8	44
1265/2	285	1267/20	285	1268/38	285	1271/6	283	1281/8	356	1297/16	38	1308/8	270
1265/3	285	1267/21	285	1268/39	285	1271/7	283	1281/9	357	1298/1	293	1308/9	44
1265/4	285	1267/22	285	1268/40	285	1271/8	283	1281/10	357	1298/2	293	1308/9	270
1265/5	285	1267/23	285	1268/41	285	1273/1	286	1281/11	357	1298/3	293	1308/11	44
1265/6	285	1267/24	285	1268/42	285	1273/2	286	1281/12	357	1298/4	293	1308/11	270
1265/7	285	1267/25	285	1268/43	285	1273/3	286	1281/13	357	1298/5	293	1308/12	44
1265/8	285	1267/26	285	1268/44	285	1273/4	286	1281/14	357	1298/6	293	1308/12	270
1265/9	285	1267/27	285	1268/45	285	1273/5	286	1283/1	296	1298/7	39	1308/13	44
1265/10	285	1267/28	285	1268/46	285	1273/6	286	1283/2	296	1298/7	294	1308/13	270
1265/11	282	1267/29	282	1268/47	282	1273/7	286	1283/3	296	1298/8	294	1309/1	288
1265/12	282	1267/30	282	1268/48	282	1273/8	286	1283/4	37	1298/9	34	1309/2	288
1265/13	282	1267/31	282	1268/49	282	1273/9	286	1283/5	37	1298/10	39	1309/3	288
1265/14	282	1267/32	282	1268/50	282	1273/10	286	1283/6	35	1298/11	35	1309/4	288
1265/15	282	1267/33	282	1268/51	282	1273/11	286	1283/7	37	1298/12	34	1309/5	288
1265/16	282	1267/34	282	1268/52	282	1273/12	286	1290/1	38	1298/13	37	1310/1	293
1265/17	282	1267/35	282	1268/53	282	1273/13	286	1290/2	38	1299/1	429	1310/2	293
1265/18	282	1267/36	282	1268/54	282	1273/14	286	1290/3	37	1299/1	43	1310/3	293
1265/19	285	1267/37	285	1269/1	277	1273/15	286	1291/1	37	1299/2	37	1310/4	293
1265/20	285	1267/38	285	1269/2	277	1273/16	286	1291/2	37	1299/5	51	1310/5	293
1265/21	285	1267/39	285	1269/3	277	1273/17	286	1291/3	37	1299/6	51	1310/6	293
1265/22	285	1267/40	285	1269/4	277	1273/18	286	1291/4	44	1299/7	51	1310/7	293
1265/23	285	1267/41	285	1269/5	277	1273/19	286	1291/5	41	1299/8	51	1311/1	352
1265/24	285	1267/42	285	1269/6	277	1273/20	286	1292/1	117	1300/1	75	1311/2	352
1265/25	285	1267/43	285	1269/7	277	1273/21	286	1292/1	294	1300/2	75	1311/3	352
1265/26	285	1267/44	285	1269/8	277	1273/22	286	1292/2	117	1300/3	75	1311/4	352
1265/27	285	1267/45	285	1269/9	277	1273/23	286	1292/2	294	1300/4	74	1312/1	357
1265/28	285	1267/46	285	1269/10	277	1273/24	286	1292/3	117	1301/1	22	1314/1	289
1265/29	282	1267/47	282	1269/11	277	1273/25	286	1292/3	294	1301/2	22	1314/2	289
1265/30	282	1267/48	282	1269/12	277	1273/26	286	1294/1	21	1301/3	22	1314/3	289
1265/31	282	1267/49	282	1269/13	277	1273/27	286	1294/2	21	1301/4	22	1315/1	290
1265/32	282	1267/50	282	1269/14	277	1273/28	286	1294/3	21	1301/5	22	1315/2	35
1265/33	282	1267/51	282	1270/1	286	1273/29	286	1294/4	21	1301/6	22	1317/1	46
1265/34	282	1267/52	282	1270/2	286	1273/30	286	1294/5	21	1301/7	22	1317/2	46
1265/35	282	1267/53	282	1270/3	286	1273/31	286	1294/6	21	1301/8	22	1317/3	47

1317/4	47	1319/36	48	1324/8	164	1360/9	310	1374/15	257	1378/4	247	1385/11	325
1317/5	47	1319/37	48	1324/9	164	1360/10	310	1374/16	257	1378/5	247	1385/11	391
1317/6	46	1319/38	48	1324/10	164	1360/11	310	1374/17	257	1378/6	245	1385/12	391
1317/7	46	1320/1	46	1324/11	164	1360/12	310	1374/18	257	1378/7	246	1385/13	324
1317/8	46	1320/2	46	1324/12	164	1360/13	310	1374/19	257	1378/8	246	1385/13	391
1317/9	46	1320/3	46	1325/1	206	1361/1	301	1374/20	257	1378/9	246	1385/14	324
1317/10	46	1320/4	46	1325/2	206	1361/2	301	1374/21	257	1378/10	248	1385/14	391
1317/11	46	1320/5	46	1325/3	164	1361/3	301	1374/22	257	1378/11	245	1385/15	391
1317/12	47	1320/6	46	1325/4	164	1361/4	301	1374/23	257	1378/12	247	1386/1	394
1317/13	47	1320/7	46	1325/5	164	1361/5	301	1374/24	257	1378/13	247	1386/2	394
1317/14	47	1320/8	46	1325/6	164	1361/6	301	1374/25	257	1378/14	247	1386/3	394
1317/15	47	1320/9	46	1325/7	164	1361/7	301	1374/26	257	1378/15	245	1386/4	394
1317/16	47	1320/10	46	1325/8	164	1361/8	301	1374/27	257	1378/16	246	1386/5	391
1317/17	47	1320/11	46	1325/9	164	1368/1	268	1374/28	257	1378/17	246	1386/6	391
1317/18	47	1320/12	46	1325/10	164	1368/2	268	1374/29	257	1378/18	246	1386/7	386
1317/19	47	1320/13	47	1326/1	267	1368/3	268	1374/30	257	1380/1	399	1386/8	386
1317/20	47	1320/14	47	1328/1	436	1368/4	268	1375/1	266	1380/2	399	1386/9	386
1317/21	47	1320/15	47	1328/2	436	1368/5	268	1375/2	266	1381/1	392	1386/10	386
1317/22	47	1320/16	47	1328/3	417	1368/6	268	1375/3	266	1381/2	392	1386/11	396
1317/23	47	1320/17	47	1328/4	435	1368/7	268	1377/1	248	1381/3	392	1386/12	386
1318/1	47	1320/18	47	1328/5	43	1368/8	268	1377/1/T	242	1381/4	392	1386/13	386
1318/2	47	1320/19	47	1328/5	435	1368/9	268	1377/2	248	1381/5	392	1387/1	387
1318/3	47	1320/20	47	1328/6	433	1368/10	268	1377/2/T	242	1381/6	392	1387/2	387
1318/4	47	1320/21	47	1328/7	438	1368/11	268	1377/3	248	1381/7	392	1387/3	387
1318/5	47	1320/22	47	1328/8	438	1368/12	268	1377/3/T	242	1381/8	392	1389/1	369
1318/6	47	1320/23	47	1328/9	438	1368/13	268	1377/4	248	1381/9	392	1389/2	369
1318/7	47	1320/24	47	1329/1	426	1368/14	268	1377/4/T	242	1381/10	392	1389/3	369
1318/8	47	1320/25	47	1329/2	426	1368/15	268	1377/5	243	1381/11	392	1389/4	369
1318/9	47	1320/26	47	1329/3	426	1368/16	268	1377/5/T	240	1381/12	392	1389/5	369
1318/10	47	1320/27	47	1329/4	426	1368/17	268	1377/6	241	1381/13	392	1389/6	369
1318/11	47	1320/28	47	1329/5	426	1368/18	268	1377/7	241	1381/14	392	1390/1	366
1318/12	47	1320/29	47	1329/6	416	1368/19	268	1377/7/T	240	1381/15	392	1390/2	366
1318/13	47	1320/30	47	1330/1	425	1368/20	268	1377/8	241	1381/16	392	1390/3	366
1318/14	47	1320/31	51	1330/2	425	1368/21	268	1377/8/T	240	1381/17	392	1390/4	366
1318/15	47	1320/32	51	1330/3	425	1368/22	268	1377/9	241	1381/18	392	1390/5	366
1318/16	47	1320/33	51	1330/4	425	1368/23	268	1377/9/T	240	1382/1	392	1391/1	362
1318/17	47	1320/34	50	1330/5	439	1368/24	268	1377/14	248	1382/2	392	1391/2	362
1319/1	47	1320/35	50	1330/6	439	1368/25	268	1377/14/T	242	1382/3	392	1391/3	362
1319/2	47	1321/1	470	1330/7	439	1369/1	262	1377/15	248	1382/4	392	1391/4	362
1319/3	47	1321/2	470	1330/8	439	1369/2	262	1377/15/T	242	1382/5	392	1391/5	362
1319/4	47	1321/3	470	1330/9	439	1370/1	267	1377/16	248	1382/6	392	1391/6	362
1319/5	47	1321/4	470	1330/10	439	1370/2	267	1377/16/T	242	1382/7	392	1391/7	362
1319/6	47	1321/5	470	1330/11	439	1370/3	267	1377/17	248	1382/8	392	1391/8	362
1319/7	48	1321/6	470	1330/12	439	1370/4	267	1377/17/T	242	1382/9	392	1391/9	362
1319/8	48	1321/7	470	1330/13	439	1370/5	258	1377/18	243	1382/10	392	1391/10	362
1319/9	48	1321/8	470	1330/14	439	1370/6	258	1377/18/T	240	1382/11	392	1391/11	362
1319/10	48	1321/9	470	1331/1	425	1370/7	258	1377/19	241	1382/12	392	1391/12	362
1319/11	48	1321/10	470	1331/2	425	1370/8	258	1377/20	241	1382/13	392	1391/13	362
1319/12	48	1321/11	470	1331/3	425	1370/9	258	1377/20/T	240	1382/14	392	1391/14	362
1319/13	48	1321/12	470	1331/4	425	1370/10	267	1377/21	241	1382/15	392	1391/15	362
1319/14	48	1323/1	71	1331/5	439	1370/11	258	1377/21/T	240	1382/16	392	1391/16	362
1319/15	48	1323/2	71	1331/6	439	1370/12	258	1377/22	241	1382/17	392	1391/17	362
1319/16	48	1323/3	71	1331/7	439	1370/13	267	1377/22/T	240	1382/18	392	1391/18	362
1319/17	48	1323/4	71	1331/8	439	1370/14	267	1377/23	234	1382/19	392	1391/19	362
1319/18	48	1323/5	71	1331/9	439	1373/1	251	1377/24	234	1382/20	392	1391/20	362
1319/19	48	1323/6	71	1331/10	439	1373/2	234	1377/25	234	1382/21	392	1391/21	363
1319/20	48	1323/7	71	1356/1	317	1373/3	234	1377/31	243	1382/22	392	1391/22	363
1319/21	48	1323/8	71	1356/2	317	1373/4	234	1377/33	241	1385/1	399	1391/23	363
1319/22	48	1323/9	71	1356/3	317	1374/1	257	1377/34	241	1385/2	399	1392/1	360
1319/23	48	1323/10	71	1358/1	316	1374/2	257	1377/35	241	1385/3	399	1392/2	360
1319/24	48	1323/11	71	1358/2	316	1374/3	257	1377/36	234	1385/4	323	1392/3	361
1319/25	48	1323/12	71	1358/3	317	1374/4	257	1377/37	234	1385/4	391	1392/4	361
1319/26	48	1323/13	71	1358/4	317	1374/5	257	1377/38	234	1385/5	323	1392/5	363
1319/27	48	1323/14	71	1358/5	317	1374/6	257	1377/40	237	1385/5	391	1392/6	363
1319/28	48	1323/15	71	1360/1	300	1374/7	257	1377/40/T	239	1385/6	391	1392/7	363
1319/29	48	1324/1	164	1360/2	300	1374/8	257	1377/41	237	1385/7	322	1393/1	71
1319/30	48	1324/2	164	1360/3	300	1374/9	257	1377/41/T	249	1385/7	391	1393/2	68
1319/31	48	1324/3	164	1360/4	300	1374/10	257	1377/42	237	1385/8	322	1393/3	406
1319/32	48	1324/4	164	1360/5	300	1374/11	257	1377/42/T	242	1385/8	391	1393/3	438
1319/33	48	1324/5	164	1360/6	298	1374/12	257	1378/1	248	1385/9	391	1393/4	429
1319/34	48	1324/6	164	1360/7	299	1374/13	257	1378/2	245	1385/10	325	1393/5	429
1319/35	48	1324/7	164	1360/8	310	1374/14	257	1378/3	247	1385/10	391	1393/6	429

INDICE - INDEX

1393/7	405	1404/6	403	1412/6	471	1414/22	472	1422/A/5	544	1425/3	550	1435/4	540
1393/8	420	1404/7	403	1412/7	471	1416/1	549	1422/A/6	544	1425/3/X	550	1435/5	540
1393/9	420	1404/8	403	1412/8	471	1416/1/X	549	1422/A/7	546	1425/4	550	1436/1	540
1393/10	373	1404/9	403	1412/9	471	1416/1/Y	549	1422/A/8	544	1425/4/X	550	1436/2	540
1393/11	373	1405/1	467	1412/10	471	1416/3	549	1422/A/9	544	1425/5	550	1436/3	540
1393/12	373	1405/2	467	1412/11	471	1416/3/X	549	1422/A/10	544	1425/5/X	550	1436/4	522
1393/13	373	1405/3	467	1412/12	471	1416/3/Y	549	1422/A/11	544	1425/6	550	1436/5	522
1393/14	373	1406/1	433	1412/13	471	1416/5	549	1422/B/1	546	1425/6/X	550	1437/1	535
1393/15	373	1406/2	432	1412/14	471	1416/5/X	549	1422/B/2	544	1425/7	550	1437/2	535
1393/16	373	1406/3	432	1412/15	471	1416/5/Y	549	1422/B/3	544	1425/7/X	550	1437/3	535
1393/17	373	1406/4	433	1412/16	471	1416/7	549	1422/B/4	544	1425/8	550	1437/4	535
1393/18	363	1406/5	432	1412/17	471	1416/8	549	1422/B/5	544	1425/8/X	550	1437/5	535
1393/19	363	1406/6	432	1412/18	471	1416/9	549	1422/B/6	550	1425/9	550	1437/6	535
1393/20	364	1406/7	432	1412/19	471	1416/10	549	1422/B/7	550	1425/9/X	550	1437/7	535
1393/21	364	1406/8	432	1412/20	471	1417/1	548	1422/B/8	550	1425/10	550	1437/8	535
1393/22	364	1406/9	432	1412/21	471	1417/1/X	548	1422/B/9	550	1425/10/X	550	1437/9	535
1393/23	364	1406/10	432	1412/22	471	1417/1/Y	548	1422/B/10	550	1425/11	550	1437/10	535
1393/24	364	1406/11	432	1412/23	471	1417/2	548	1422/B/11	550	1425/11/X	550	1437/11	535
1393/25	363	1408/1	406	1412/24	471	1417/2/X	548	1422/B/12	550	1425/12	550	1437/12	535
1393/26	363	1408/2	406	1412/25	471	1417/2/Y	548	1422/B/13	550	1425/12/X	550	1437/13	535
1393/27	363	1408/3	408	1412/26	471	1417/3	548	1422/B/14	550	1425/13	550	1437/14	535
1393/28	363	1408/4	408	1412/27	471	1417/3/X	548	1422/B/15	550	1425/13/X	550	1437/15	535
1394/1	382	1408/5	404	1412/28	471	1417/3/Y	548	1422/B/16	546	1425/14	542	1437/16	521
1394/2	382	1408/6	404	1413/1	471	1418/1	548	1422/B/17	546	1425/15	542	1437/17	521
1394/3	382	1408/7	404	1413/2	471	1418/1/X	548	1422/B/18	546	1425/16	543	1437/18	521
1394/4	382	1408/8	404	1413/3	471	1418/1/Y	548	1422/B/19	546	1425/17	543	1437/19	520
1394/5	382	1408/9	404	1413/4	471	1418/2	548	1422/C/1	546	1425/18	542	1437/20	535
1394/6	382	1408/10	404	1413/5	471	1418/2/X	548	1422/C/2	546	1425/19	543	1438/1	524
1394/7	382	1408/11	404	1413/6	471	1418/2/Y	548	1422/C/3	546	1425/20	543	1438/2	524
1394/8	382	1408/12	404	1413/7	471	1418/3	548	1422/C/4	546	1425/21	543	1438/3	521
1394/9	382	1408/13	404	1413/8	471	1418/3/X	548	1422/C/5	546	1425/22	543	1440/1	528
1394/10	382	1408/14	404	1413/9	471	1418/3/Y	548	1422/C/6	546	1425/23	542	1440/2	528
1394/11	382	1408/15	404	1413/10	471	1419/1	549	1422/C/7	547	1425/24	542	1443/1	523
1394/12	382	1408/16	404	1413/11	471	1419/1/X	549	1422/C/8	547	1425/25	542	1443/2	523
1394/13	382	1408/17	404	1413/12	471	1419/1/Y	549	1422/C/9	547	1425/26	542	1443/3	523
1394/14	382	1408/18	404	1413/13	471	1419/2	549	1422/C/10	547	1425/27	543	1443/4	523
1394/15	382	1408/19	404	1413/14	471	1419/2/X	549	1422/C/11	545	1425/28	543	1443/5	523
1394/16	382	1408/20	404	1413/15	471	1419/2/Y	549	1422/C/12	545	1425/29	543	1443/6	523
1394/17	382	1408/21	404	1413/16	471	1419/3	548	1422/C/13	545	1425/30	543	1443/7	523
1394/18	382	1409/1	470	1413/17	471	1419/3/X	548	1422/C/14	545	1425/31	543	1443/8	523
1394/19	382	1409/2	470	1413/18	471	1419/3/Y	548	1423/1	552	1425/32	543	1443/9	523
1394/20	382	1409/3	470	1413/19	471	1419/4	549	1423/2	554	1425/33	543	1443/10	523
1394/21	383	1409/4	470	1413/20	471	1419/4/X	549	1423/3	553	1425/34	543	1443/11	523
1394/22	383	1409/5	470	1413/21	471	1419/4/Y	549	1423/4	554	1425/35	543	1443/12	523
1394/23	383	1409/6	470	1413/22	471	1420/1	549	1423/5	552	1426/2	544	1443/13	523
1394/24	383	1409/7	470	1413/23	471	1420/1/X	549	1423/6	552	1426/3	544	1444/1	527
1394/25	383	1409/8	470	1413/24	471	1420/1/Y	549	1423/7	553	1426/4	550	1444/2	527
1395/1	383	1410/1	470	1413/25	471	1420/2	549	1423/8	553	1426/5	550	1444/3	527
1395/2	383	1410/2	470	1413/26	471	1420/2/X	549	1423/9	554	1426/6	550	1444/4	528
1395/3	383	1410/3	470	1413/27	471	1420/2/Y	549	1423/10	554	1426/7	550	1444/5	528
1395/4	383	1410/4	470	1413/28	471	1420/3	549	1423/11	551	1426/8	550	1444/6	526
1395/5	383	1410/5	470	1414/1	472	1420/3/X	549	1423/12	551	1426/9	550	1444/7	525
1395/6	383	1410/6	470	1414/2	472	1420/3/Y	549	1424/1	552	1426/10	545	1444/8	525
1395/7	383	1410/7	470	1414/3	472	1422/1	545	1424/2	554	1426/11	545	1444/9	525
1395/8	383	1410/8	470	1414/4	472	1422/2	545	1424/3	553	1426/12	545	1444/10	528
1395/9	383	1411/1	470	1414/5	472	1422/3	545	1424/4	554	1426/13	550	1444/11	527
1395/10	383	1411/2	470	1414/6	472	1422/4	545	1424/5	552	1426/14	550	1444/12	527
1396/1	384	1411/3	470	1414/7	472	1422/5	546	1424/6	552	1426/15	550	1444/13	527
1396/2	384	1411/4	470	1414/8	472	1422/6	546	1424/7	553	1426/A/1	549	1444/14	528
1396/3	384	1411/5	470	1414/9	472	1422/7	546	1424/8	553	1426/A/2	547	1444/15	528
1396/4	384	1411/6	470	1414/10	472	1422/8	546	1424/9	552	1426/A/3	547	1444/16	526
1396/5	384	1411/7	470	1414/11	472	1422/9	545	1424/10	554	1426/A/4	547	1444/17	525
1398/1	403	1411/8	470	1414/12	472	1422/10	545	1424/11	553	1426/A/5	547	1444/18	525
1398/2	403	1411/9	470	1414/13	472	1422/11	545	1424/12	554	1426/A/6	547	1444/19	528
1399/1	403	1411/10	438	1414/14	472	1422/12	546	1424/13	552	1426/A/7	547	1445/1	529
1400/1	403	1411/11	438	1414/15	472	1422/13	546	1424/14	552	1426/A/8	547	1445/2	529
1400/2	403	1411/12	438	1414/16	472	1422/14	544	1424/15	553	1426/A/9	547	1445/3	529
1404/1	403	1412/1	471	1414/17	472	1422/15	544	1424/16	553	1426/A/10	547	1445/4	529
1404/2	403	1412/2	471	1414/18	472	1422/A/1	544	1424/18	551	1426/A/11	547	1445/5	529
1404/3	403	1412/3	471	1414/19	472	1422/A/2	544	1424/19	551	1435/1	540	1446/1	529
1404/4	403	1412/4	471	1414/20	472	1422/A/3	544	1425/1	550	1435/2	540	1446/2	529
1404/5	403	1412/5	471	1414/21	472	1422/A/4	544	1425/2	550	1435/3	540	1446/3	529

1446/4	529	1452/8	539	1461/6	513	1465/13	499	1471/3006/24	494	1530/4	478	1535/4	480
1446/5	529	1452/9	539	1462/1	513	1465/14	499	1471/3006/25	494	1530/5	478	1535/5	480
1446/6	529	1452/10	539	1462/2	513	1465/15	501	1471/3006/26	494	1530/6	478	1535/6	480
1447/1	532	1453/1	539	1462/3	514	1465/16	500	1471/3006/27	494	1530/7	478	1535/7	480
1447/2	533	1453/2	539	1462/4	514	1465/17	498	1471/3006/28	494	1530/8	478	1535/8	480
1447/3	533	1453/3	539	1462/5	514	1465/18	498	1471/3006/29	494	1531/1	478	1535/9	480
1447/4	534	1453/4	539	1462/6	514	1465/19	498	1471/3006/30	494	1531/2	478	1535/10	480
1447/5	534	1453/5	539	1462/7	513	1465/20	498	1471/3006/31	494	1531/3	478	1535/11	480
1447/6	532	1453/6	539	1462/8	513	1465/21	498	1471/3006/32	494	1531/4	478	1535/12	480
1447/7	534	1453/7	539	1463/1	514	1466/1	507	1471/3006/33	494	1531/5	479	1535/13	480
1447/8	535	1453/8	539	1463/2	514	1466/2	507	1474/1	452	1531/6	479	1535/14	480
1447/8	554	1454/1	539	1463/3	514	1466/3	506	1474/2	452	1531/7	479	1535/15	480
1447/9	531	1454/2	539	1463/4	514	1466/4	503	1474/3	452	1531/8	479	1535/16	480
1447/10	531	1454/3	539	1463/5	514	1466/5	503	1474/4	453	1531/9	479	1535/17	481
1447/11	531	1454/4	539	1463/6	506	1466/6	503	1474/5	452	1531/10	479	1535/18	481
1447/12	531	1454/5	537	1463/7	506	1466/7	503	1474/6	466	1531/11	479	1535/19	481
1447/13	533	1454/6	537	1463/8	506	1466/8	503	1474/7	466	1531/12	479	1535/20	481
1447/14	532	1454/7	537	1463/9	506	1466/9	503	1474/8	466	1531/13	479	1535/21	481
1447/15	533	1454/8	537	1463/10	506	1466/10	497	1474/9	466	1531/14	479	1535/22	481
1447/16	533	1454/9	537	1463/11	514	1466/11	497	1474/10	466	1531/15	479	1535/23	481
1447/17	534	1454/10	537	1463/12	514	1466/12	497	1475/1	451	1531/16	479	1535/24	481
1447/18	534	1454/11	538	1463/13	514	1467/1	504	1475/2	451	1532/1	478	1536/1	478
1447/19	532	1454/12	538	1463/14	514	1467/2	504	1475/3	451	1532/2	478	1536/2	478
1447/20	534	1454/13	538	1463/15	514	1467/3	504	1475/4	451	1532/3	478	1536/3	478
1447/21	533	1454/14	538	1463/16	514	1467/4	504	1475/5	451	1532/4	478	1536/4	478
1447/22	532	1454/15	538	1463/17	514	1467/5	504	1475/6	451	1532/5	478	1536/5	478
1447/23	533	1454/16	538	1464/1	501	1467/6	504	1475/7	452	1532/6	478	1536/6	478
1447/24	533	1456/1	512	1464/2	500	1467/7	504	1476/1	447	1532/7	478	1536/7	478
1447/25	534	1456/2	512	1464/3	501	1468/1	504	1476/2	447	1532/8	478	1536/8	478
1447/26	534	1456/3	512	1464/4	500	1468/2	504	1476/3	447	1533/1	478	1537/1	478
1447/27	532	1456/4	512	1464/5	499	1468/3	504	1476/4	447	1533/2	478	1537/2	478
1447/28	534	1456/5	512	1464/6	499	1468/4	504	1476/5	447	1533/3	478	1537/3	478
1447/29	531	1456/6	512	1464/7	501	1468/5	504	1476/6	447	1533/4	478	1537/4	478
1447/30	531	1456/7	512	1464/8	500	1468/6	504	1476/7	447	1533/5	479	1537/5	479
1448/1	530	1456/8	512	1464/9	502	1468/7	504	1476/8	447	1533/6	479	1537/6	479
1448/2	530	1456/9	512	1464/10	502	1468/8	504	1476/9	447	1533/7	479	1537/7	479
1448/3	530	1456/10	512	1464/11	498	1468/9	504	1476/10	447	1533/8	479	1537/8	479
1448/4	536	1456/11	512	1464/12	498	1468/10	504	1476/11	447	1533/9	479	1537/9	479
1448/5	536	1456/12	512	1464/13	502	1469/1	490	1476/12	447	1533/10	479	1537/10	479
1448/6	536	1457/1	512	1464/14	502	1470/1	491	1476/13	447	1533/11	479	1537/11	479
1448/7	536	1457/2	512	1464/15	498	1470/2	491	1476/14	447	1533/12	479	1537/12	479
1448/8	536	1457/3	512	1464/16	502	1470/3	490	1476/A/1	446	1533/13	479	1537/13	479
1448/9	536	1457/4	512	1464/17	502	1470/4	490	1476/A/2	446	1533/14	479	1537/14	479
1448/10	536	1457/5	512	1464/18	502	1470/5	490	1476/A/3	446	1533/15	479	1537/15	479
1448/11	536	1457/6	512	1464/19	502	1470/6	490	1476/A/4	446	1533/16	479	1537/16	479
1450/1	539	1457/7	513	1464/20	502	1470/7	490	1476/A/5	446	1534/1	480	1538/1	478
1450/2	539	1458/1	512	1464/21	502	1470/8	407	1476/A/6	446	1534/2	480	1538/2	478
1450/3	539	1458/2	512	1464/22	502	1470/9	407	1476/A/7	446	1534/3	480	1538/3	478
1450/4	539	1458/3	512	1464/23	502	1471/3006/0	494	1476/A/8	446	1534/4	480	1538/4	478
1450/5	539	1458/4	512	1464/24	502	1471/3006/1	494	1476/A/9	446	1534/5	480	1538/5	478
1450/6	539	1458/5	513	1464/25	502	1471/3006/2	494	1476/A/10	446	1534/6	480	1538/6	478
1450/7	539	1458/6	513	1464/26	502	1471/3006/3	494	1476/A/11	446	1534/7	480	1538/7	478
1450/8	539	1458/7	513	1464/27	502	1471/3006/4	494	1476/A/12	446	1534/8	480	1538/8	478
1450/9	539	1458/8	513	1464/28	502	1471/3006/5	494	1476/A/13	446	1534/9	480	1539/1	478
1450/10	539	1458/9	513	1464/29	502	1471/3006/6	494	1476/A/14	446	1534/10	480	1539/2	478
1451/1	538	1458/10	513	1464/30	502	1471/3006/7	494	1476/A/15	446	1534/11	480	1539/3	478
1451/2	538	1458/11	513	1464/31	502	1471/3006/8	494	1487/1	155	1534/12	480	1539/4	478
1451/3	538	1458/12	513	1464/32	502	1471/3006/9	494	1487/2	155	1534/13	480	1539/5	479
1451/4	538	1458/13	512	1464/33	502	1471/3006/10	494	1489/7	158	1534/14	480	1539/6	479
1451/5	538	1458/14	512	1464/34	498	1471/3006/11	494	1489/8	158	1534/15	480	1539/7	479
1451/6	538	1460/1	513	1465/1	501	1471/3006/12	494	1490/1	190	1534/16	480	1539/8	479
1451/7	538	1460/2	513	1465/2	500	1471/3006/13	494	1490/2	190	1534/17	481	1539/9	479
1451/8	538	1460/3	514	1465/3	501	1471/3006/14	494	1490/3	190	1534/18	481	1539/10	479
1451/9	538	1460/4	514	1465/4	500	1471/3006/15	494	1490/4	190	1534/19	481	1539/11	479
1451/10	538	1460/5	514	1465/5	499	1471/3006/16	494	1491/1	367	1534/20	481	1539/12	479
1452/1	538	1460/6	514	1465/6	499	1471/3006/17	494	1491/2	367	1534/21	481	1539/13	479
1452/2	538	1460/7	514	1465/7	501	1471/3006/18	494	1491/3	367	1534/22	481	1539/14	479
1452/3	537	1461/1	514	1465/8	500	1471/3006/19	494	1491/4	367	1534/23	481	1539/15	479
1452/4	537	1461/2	514	1465/9	501	1471/3006/20	494	1491/5	367	1534/24	481	1539/16	479
1452/5	537	1461/3	513	1465/10	500	1471/3006/21	494	1530/1	478	1535/1	480	1540/1	159
1452/6	537	1461/4	513	1465/11	501	1471/3006/22	494	1530/2	478	1535/2	480	1540/2	159
1452/7	539	1461/5	513	1465/12	500	1471/3006/23	494	1530/3	478	1535/3	480	1540/3	159

INDICE - INDEX

1540/4	159	1665/5	64	1695/4	201	1707/3	150	1714/3	151	1722/3	346	1725/2	224
1540/5	159	1665/6	64	1695/5	201	1707/4	150	1714/4	151	1722/4	346	1725/3	224
1540/6	492	1665/7	64	1695/6	201	1707/5	150	1714/5	151	1723/1	140	1725/4	224
1540/7	492	1665/8	64	1695/7	201	1707/6	150	1714/6	151	1723/2	140	1725/5	224
1540/8	492	1665/9	64	1695/8	201	1707/7	154	1714/7	154	1723/3	140	1725/6	224
1540/9	492	1665/10	64	1695/9	201	1707/8	155	1714/8	154	1723/4	140	1725/7	224
1559/1	463	1665/11	64	1695/10	201	1707/9	193	1714/9	156	1723/5	140	1725/8	224
1559/2	463	1665/12	64	1695/11	201	1707/10	154	1714/10	156	1723/6	140	1725/9	224
1596/1	596	1665/13	64	1695/12	201	1707/11	155	1714/11	155	1723/7	140	1725/10	224
1601/1	597	1665/14	64	1696/1	179	1707/12	193	1714/12	155	1724/1	224	1725/11	224
1601/2	597	1665/15	64	1696/2	179	1709/1	151	1716/1	150	1724/2	224	1725/12	224
1639/1	67	1665/16	64	1696/3	181	1709/2	151	1716/2	150	1724/3	224	1725/13	224
1639/2	37	1665/17	64	1696/4	181	1709/3	151	1716/3	150	1724/4	224	1725/14	224
1639/3	37	1665/18	64	1696/5	181	1709/4	151	1716/4	150	1724/5	224	1725/15	224
1639/4	71	1665/19	71	1699/1	195	1709/5	151	1716/5	150	1724/6	224	1725/16	224
1641/1	54	1667/1	69	1699/2	195	1709/6	151	1716/6	150	1724/7	224	1725/17	224
1641/2	54	1667/2	63	1699/3	179	1709/7	154	1716/7	157	1724/8	224	1725/18	224
1641/3	118	1667/3	63	1699/4	195	1709/8	154	1716/8	157	1724/9	224	1725/19	224
1641/4	118	1667/4	36	1699/5	195	1709/9	155	1716/9	193	1724/10	224	1725/20	224
1641/5	54	1667/5	43	1699/6	195	1709/10	155	1716/10	193	1724/11	224	1725/21	224
1641/6	54	1668/1	63	1699/7	195	1709/11	193	1716/11	155	1724/12	224	1725/22	224
1642/1	62	1668/2	63	1699/8	206	1709/12	193	1716/12	155	1724/13	224	1725/23	224
1643/1	62	1668/3	69	1699/9	206	1709/13	151	1716/13	151	1724/14	224	1725/24	224
1644/1	62	1670/1	78	1699/10	438	1709/14	151	1716/14	151	1724/15	224	1727/1	152
1645/1	62	1670/2	78	1699/11	438	1709/15	151	1716/15	151	1724/16	224	1727/2	152
1647/1	62	1671/1	79	1701/1	151	1709/16	151	1716/16	151	1724/17	224	1727/3	152
1647/2	81	1671/2	79	1701/2	151	1709/17	151	1716/17	151	1724/18	224	1727/4	152
1647/3	81	1671/3	78	1701/3	151	1709/18	151	1716/18	151	1724/19	224	1727/5	154
1647/4	71	1671/4	78	1701/4	151	1709/19	157	1716/19	157	1724/20	224	1727/6	154
1647/5	71	1671/5	78	1701/5	151	1709/20	157	1716/20	157	1724/21	224	1727/7	154
1648/1	63	1671/6	78	1701/6	151	1709/21	155	1716/21	193	1724/22	224	1727/8	154
1648/2	68	1672/1	116	1701/7	154	1709/22	155	1716/22	193	1724/23	224	1729/1	152
1648/3	68	1672/2	116	1701/8	154	1709/23	193	1716/23	155	1724/24	224	1729/2	152
1648/4	68	1672/3	116	1701/9	156	1709/24	193	1716/24	155	1724/25	224	1729/3	152
1649/1	67	1674/1	116	1701/10	156	1710/1	150	1718/1	160	1724/26	224	1729/4	152
1650/1	67	1674/2	116	1701/11	157	1710/2	150	1718/2	160	1724/27	224	1729/5	154
1651/1	67	1674/3	116	1701/12	157	1710/3	150	1718/3	160	1724/28	224	1729/6	154
1652/1	70	1675/1	116	1701/13	276	1710/4	150	1718/4	160	1724/29	224	1729/7	154
1652/2	70	1675/2	116	1701/14	276	1710/5	150	1718/5	160	1724/30	224	1729/8	154
1652/3	70	1675/3	116	1701/15	230	1710/6	150	1718/6	160	1724/31	224	1729/11	152
1652/4	70	1676/1	116	1702/1	151	1710/7	154	1718/7	160	1724/32	224	1729/12	152
1652/5	70	1676/2	116	1702/2	151	1710/8	154	1718/8	160	1724/33	224	1730/1	152
1652/6	70	1676/3	116	1702/3	151	1710/9	155	1718/9	152	1724/34	224	1730/2	152
1652/7	70	1677/1	116	1702/4	151	1710/10	155	1718/10	152	1724/35	224	1730/3	152
1652/8	70	1677/2	116	1702/5	151	1710/11	193	1718/11	152	1724/36	224	1730/4	152
1653/1	70	1677/3	116	1702/6	151	1710/12	193	1718/12	152	1724/37	224	1730/5	152
1653/2	70	1678/1	118	1702/7	157	1710/13	151	1718/13	152	1724/38	224	1730/6	152
1655/1	67	1678/2	201	1702/8	157	1710/14	151	1718/14	152	1724/39	224	1730/7	152
1655/2	37	1678/3	206	1702/9	157	1710/15	151	1718/15	152	1724/40	224	1730/8	152
1655/3	37	1678/4	206	1702/10	157	1710/16	151	1718/16	152	1724/41	224	1730/9	148
1655/4	118	1680/1	174	1702/11	157	1710/17	151	1718/17	231	1724/42	224	1730/10	148
1657/1	58	1680/2	84	1702/12	157	1710/18	151	1718/18	231	1724/43	224	1730/11	148
1657/2	118	1681/1	84	1702/13	276	1710/19	157	1720/1	159	1724/44	224	1730/12	148
1657/3	118	1682/1	113	1702/14	276	1710/20	157	1720/2	159	1724/45	224	1730/13	154
1657/4	58	1682/2	113	1702/15	230	1710/21	155	1720/3	159	1724/46	224	1730/14	154
1658/1	55	1685/1	113	1705/1	150	1710/22	155	1720/4	159	1724/47	224	1730/15	154
1658/2	55	1685/2	113	1705/2	150	1710/23	193	1720/5	159	1724/48	224	1730/16	154
1659/1	60	1685/3	169	1705/3	150	1710/24	193	1720/6	159	1724/49	224	1730/17	225
1659/2	64	1687/1	120	1705/4	150	1713/1	151	1720/7	159	1724/50	224	1733/1	150
1661/1	70	1687/2	120	1705/5	150	1713/2	151	1720/8	159	1724/51	224	1733/2	150
1661/2	70	1688/1	201	1705/6	150	1713/3	151	1720/9	159	1724/52	224	1733/3	150
1661/3	70	1688/2	201	1705/7	154	1713/4	151	1720/10	159	1724/53	224	1733/4	150
1661/4	70	1688/3	201	1705/8	154	1713/5	151	1720/11	159	1724/54	224	1733/5	151
1661/5	70	1688/4	201	1705/9	157	1713/6	151	1720/12	159	1724/55	224	1733/6	151
1661/6	70	1688/5	166	1705/10	157	1713/7	157	1721/1	159	1724/56	224	1733/7	151
1661/7	70	1688/6	166	1705/11	157	1713/8	157	1721/2	159	1724/57	224	1733/8	151
1661/8	70	1690/1	166	1705/12	157	1713/9	155	1721/3	159	1724/58	224	1733/9	151
1661/9	71	1691/1	166	1705/13	276	1713/10	155	1721/4	159	1724/59	224	1733/10	151
1665/1	35	1692/1	166	1705/14	276	1713/11	193	1721/5	159	1724/60	224	1733/11	151
1665/2	35	1695/1	201	1705/15	230	1713/12	193	1721/6	159	1724/61	224	1733/12	151
1665/3	35	1695/2	201	1707/1	150	1714/1	151	1722/1	398	1724/62	224	1733/13	148
1665/4	64	1695/3	201	1707/2	150	1714/2	151	1722/2	346	1725/1	224	1733/14	148

1733/15	148	1754/32	340	1757/8	336	1758/2	336	1759/13	335	1764/37	328	1765/7	326
1733/16	148	1754/33	340	1757/9	336	1758/3	336	1759/14	335	1764/38	328	1765/8	326
1733/17	145	1754/34	340	1757/10	336	1758/4	336	1759/15	335	1764/39	328	1765/9	326
1733/18	145	1754/35	340	1757/11	336	1758/5	336	1759/16	335	1764/40	328	1765/10	326
1733/19	145	1754/36	340	1757/12	336	1758/6	336	1759/17	335	1764/41	328	1765/11	391
1733/20	145	1754/37	340	1757/13	336	1758/7	336	1759/18	335	1764/42	328	1765/12	326
1734/1	160	1754/38	340	1757/14	336	1758/8	336	1759/19	335	1764/43	328	1765/13	326
1734/2	160	1754/39	340	1757/15	336	1758/9	336	1759/20	335	1764/44	328	1765/14	326
1741/3	113	1754/40	340	1757/16	336	1758/10	336	1759/21	335	1764/45	328	1765/15	326
1746/1	163	1754/41	340	1757/17	336	1758/11	336	1759/22	335	1764/46	328	1765/16	391
1746/2	163	1754/42	340	1757/18	336	1758/12	336	1759/23	335	1764/47	328	1765/17	326
1746/3	163	1754/43	340	1757/19	336	1758/13	336	1759/24	335	1764/48	328	1765/18	326
1746/4	163	1754/44	340	1757/20	336	1758/14	336	1759/25	335	1764/49	328	1765/19	326
1746/5	163	1754/45	393	1757/21	336	1758/15	336	1759/26	335	1764/50	328	1765/20	326
1746/6	163	1754/46	393	1757/22	336	1758/16	336	1759/27	335	1764/51	328	1765/21	391
1749/1	139	1754/47	393	1757/23	336	1758/17	336	1759/28	335	1764/52	328	1765/22	326
1749/2	139	1754/48	340	1757/24	336	1758/18	336	1759/29	335	1764/53	328	1765/23	326
1749/3	139	1756/1	341	1757/25	336	1758/19	336	1759/30	335	1764/54	328	1765/24	326
1749/4	139	1756/2	341	1757/26	336	1758/20	336	1759/31	335	1764/55	328	1765/25	326
1749/5	156	1756/3	341	1757/27	336	1758/21	336	1759/32	335	1764/56	328	1765/26	391
1749/5	156	1756/4	341	1757/28	336	1758/22	336	1759/33	335	1764/57	328	1765/27	326
1749/6	156	1756/5	341	1757/29	336	1758/23	336	1759/34	335	1764/58	328	1765/28	326
1749/7	156	1756/6	341	1757/30	336	1758/24	336	1759/35	335	1764/59	328	1765/29	326
1749/8	156	1756/7	341	1757/31	336	1758/25	336	1759/36	335	1764/60	328	1765/30	326
1749/9	138	1756/8	341	1757/32	336	1758/26	336	1759/37	335	1764/61	328	1765/31	391
1749/10	138	1756/9	341	1757/33	336	1758/27	336	1759/38	335	1764/62	328	1765/32	326
1749/11	138	1756/10	341	1757/34	336	1758/28	336	1759/39	335	1764/63	328	1765/33	326
1749/12	138	1756/11	341	1757/35	336	1758/29	336	1759/40	335	1764/64	328	1765/34	326
1751/1	116	1756/12	341	1757/36	336	1758/30	336	1759/41	335	1764/65	328	1765/35	326
1751/2	116	1756/13	341	1757/37	336	1758/31	336	1759/42	335	1764/66	328	1765/36	391
1751/3	116	1756/14	341	1757/38	336	1758/32	336	1759/43	335	1764/67	328	1765/37	326
1751/4	116	1756/15	341	1757/39	336	1758/33	336	1759/44	335	1764/68	328	1765/38	326
1751/5	225	1756/16	341	1757/40	336	1758/34	336	1759/45	392	1764/69	328	1765/39	326
1751/6	514	1756/17	341	1757/41	336	1758/35	336	1759/46	392	1764/70	328	1765/40	326
1753/1	176	1756/18	341	1757/42	336	1758/36	336	1759/47	392	1764/71	328	1765/41	391
1753/2	198	1756/19	341	1757/43	336	1758/37	336	1759/48	392	1764/72	328	1765/42	326
1753/3	197	1756/20	341	1757/44	336	1758/38	336	1764/1	328	1764/73	328	1765/43	326
1753/4	119	1756/21	341	1757/45	336	1758/39	336	1764/2	328	1764/74	328	1765/44	326
1753/5	181	1756/22	341	1757/46	336	1758/40	336	1764/3	328	1764/75	328	1765/45	326
1753/6	203	1756/23	341	1757/47	336	1758/41	336	1764/4	328	1764/76	328	1765/46	391
1753/7	176	1756/24	341	1757/48	336	1758/42	336	1764/5	328	1764/77	328	1765/47	326
1754/1	340	1756/25	341	1757/49	336	1758/43	336	1764/6	328	1764/78	328	1765/48	326
1754/2	340	1756/26	341	1757/50	336	1758/44	336	1764/7	328	1764/79	328	1765/49	326
1754/3	340	1756/27	341	1757/51	336	1758/45	336	1764/8	328	1764/80	328	1765/50	326
1754/4	340	1756/28	341	1757/52	336	1758/46	336	1764/9	328	1764/81	328	1765/51	391
1754/5	340	1756/29	341	1757/53	336	1758/47	336	1764/10	328	1764/82	328	1765/52	326
1754/6	340	1756/30	341	1757/54	336	1758/48	336	1764/11	328	1764/83	328	1765/53	326
1754/7	340	1756/31	341	1757/55	336	1758/49	336	1764/12	328	1764/84	328	1765/54	326
1754/8	340	1756/32	341	1757/56	336	1758/50	336	1764/13	328	1764/85	328	1765/55	326
1754/9	340	1756/33	341	1757/57	336	1758/51	336	1764/14	328	1764/86	328	1766/1	343
1754/10	340	1756/34	341	1757/58	336	1758/52	336	1764/15	328	1764/87	328	1766/2	343
1754/11	340	1756/35	341	1757/59	336	1758/53	336	1764/16	328	1764/88	328	1766/3	343
1754/12	340	1756/36	341	1757/60	336	1758/54	336	1764/17	328	1764/89	328	1766/4	343
1754/13	340	1756/37	340	1757/61	336	1758/55	336	1764/18	328	1764/90	328	1766/5	343
1754/14	340	1756/38	340	1757/62	336	1758/56	336	1764/19	328	1764/91	328	1766/6	343
1754/15	340	1756/39	340	1757/63	336	1758/57	336	1764/20	328	1764/92	328	1766/7	343
1754/16	340	1756/40	340	1757/64	336	1758/58	336	1764/21	328	1764/93	328	1766/8	343
1754/17	340	1756/41	340	1757/65	336	1758/59	336	1764/22	328	1764/94	328	1766/9	343
1754/18	340	1756/42	340	1757/66	336	1758/60	336	1764/23	328	1764/95	328	1766/10	343
1754/19	340	1756/43	340	1757/67	336	1758/61	336	1764/24	328	1764/96	328	1766/11	343
1754/20	340	1756/44	340	1757/68	336	1759/1	335	1764/25	328	1764/97	328	1766/12	343
1754/21	340	1756/45	340	1757/69	336	1759/2	335	1764/26	328	1764/98	328	1766/13	343
1754/22	340	1756/46	340	1757/70	336	1759/3	335	1764/27	328	1764/99	328	1766/14	343
1754/23	340	1756/47	340	1757/71	336	1759/4	335	1764/28	328	1764/100	328	1766/15	343
1754/24	340	1756/48	340	1757/72	336	1759/5	335	1764/29	328	1764/101	328	1766/16	343
1754/25	340	1757/1	336	1757/73	336	1759/6	335	1764/30	328	1764/102	328	1766/17	343
1754/26	340	1757/2	336	1757/74	336	1759/7	335	1764/31	328	1765/1	393	1766/18	343
1754/27	340	1757/3	336	1757/75	336	1759/8	335	1764/32	328	1765/2	399	1766/19	343
1754/28	340	1757/4	336	1757/76	336	1759/9	335	1764/33	328	1765/3	399	1766/20	343
1754/29	340	1757/5	336	1757/77	336	1759/10	335	1764/34	328	1765/4	399	1766/21	343
1754/30	340	1757/6	336	1757/78	336	1759/11	335	1764/35	328	1765/5	326	1766/22	343
1754/31	340	1757/7	336	1758/1	336	1759/12	335	1764/36	328	1765/6	326	1766/23	343

INDICE - INDEX

1766/24	343	1775/12	229	1787/3	278	1802/26	46	1802/98	46	1807/17	263	1818/6	238
1766/25	343	1775/13	225	1787/4	278	1802/27	46	1802/99	46	1807/18	263	1818/7	244
1766/26	343	1775/14	225	1787/5	278	1802/28	46	1802/100	46	1807/19	263	1818/8	244
1766/27	343	1775/15	225	1787/6	278	1802/29	46	1802/101	46	1807/20	263	1818/9	244
1766/28	343	1777/1	230	1787/7	278	1802/30	46	1802/102	46	1807/21	263	1818/10	244
1766/29	343	1777/2	230	1787/8	278	1802/31	46	1802/103	46	1807/22	263	1818/11	244
1766/30	343	1777/3	230	1787/9	278	1802/32	46	1802/104	46	1807/23	263	1818/12	244
1766/31	343	1777/4	230	1787/10	278	1802/33	46	1802/105	46	1807/24	263	1818/13	244
1766/32	343	1777/5	230	1789/1	278	1802/34	46	1802/106	46	1808/1	295	1818/14	244
1766/33	393	1777/6	230	1789/2	278	1802/35	46	1802/107	46	1808/2	295	1818/15	238
1766/34	393	1777/7	230	1789/3	278	1802/36	46	1802/108	46	1808/3	290	1818/16	238
1766/35	393	1777/8	230	1789/4	278	1802/37	46	1802/109	46	1808/4	290	1819/1	248
1766/36	393	1777/9	230	1789/5	278	1802/38	46	1802/110	46	1809/1	35	1819/2	248
1766/37	393	1779/7	274	1791/1	279	1802/39	46	1802/111	46	1809/2	37	1819/3	248
1766/38	393	1779/8	274	1791/2	279	1802/40	46	1802/112	46	1809/3	40	1819/4	248
1766/39	393	1779/9	276	1791/3	279	1802/41	46	1802/113	46	1809/4	40	1819/5	243
1766/40	393	1779/10	276	1791/4	279	1802/42	46	1802/114	46	1809/5	290	1819/6	241
1766/41	393	1779/11	276	1791/5	279	1802/43	46	1802/115	46	1809/6	290	1819/7	241
1766/42	393	1779/12	276	1791/6	279	1802/44	46	1803/1	51	1811/1	295	1819/8	241
1766/43	393	1779/13	276	1793/1	186	1802/45	46	1803/2	51	1811/2	295	1819/9	241
1766/44	393	1779/14	276	1793/2	186	1802/46	46	1803/3	51	1811/3	295	1819/10	237
1769/1	123	1779/15	274	1793/3	186	1802/47	46	1803/4	46	1811/4	295	1819/11	237
1769/2	123	1779/16	274	1793/4	186	1802/48	46	1803/5	46	1811/5	295	1819/12	23
1769/3	134	1780/1	276	1793/5	186	1802/49	46	1803/6	46	1811/6	295	1819/13	235
1769/4	134	1780/2	276	1793/7	370	1802/50	46	1803/7	46	1811/7	295	1819/14	235
1769/5	222	1780/3	276	1793/8	370	1802/51	46	1803/8	46	1811/8	295	1819/15	235
1769/6	222	1780/4	276	1793/9	186	1802/52	46	1806/1	267	1811/9	295	1819/16	235
1769/7	222	1780/5	276	1793/10	186	1802/53	46	1806/2	267	1811/10	295	1819/17	235
1769/8	222	1780/6	276	1793/11	186	1802/54	46	1806/3	267	1811/11	295	1819/18	235
1770/1	130	1780/7	274	1794/1	184	1802/55	46	1806/4	267	1811/12	295	1819/19	235
1770/2	128	1780/8	274	1794/2	184	1802/56	46	1806/5	267	1811/13	296	1819/20	235
1770/3	128	1780/9	276	1794/3	184	1802/57	46	1806/6	267	1813/1	469	1819/21	235
1770/4	123	1780/10	276	1794/4	184	1802/58	46	1806/7	267	1813/2	469	1819/22	235
1770/5	134	1780/11	276	1794/5	184	1802/59	46	1806/8	267	1813/3	469	1819/23	235
1770/6	124	1780/12	276	1794/5	232	1802/60	46	1806/9	267	1813/4	469	1819/24	235
1770/7	133	1780/13	276	1794/6	184	1802/61	46	1806/10	267	1813/5	469	1819/25	235
1770/8	23	1780/14	276	1794/6	232	1802/62	46	1806/11	267	1813/6	469	1819/26	235
1770/9	124	1780/15	274	1794/7	184	1802/63	46	1806/12	267	1814/1	249	1819/27	235
1770/10	124	1780/16	274	1794/8	184	1802/64	46	1806/13	263	1814/2	236	1819/28	235
1770/11	126	1782/1	273	1794/8	232	1802/65	46	1806/14	263	1814/3	234	1819/32	241
1770/12	126	1782/2	273	1794/9	266	1802/66	46	1806/15	263	1814/4	234	1820/1	242
1770/13	122	1782/3	273	1794/10	266	1802/67	46	1806/16	263	1814/5	234	1820/2	242
1770/14	122	1782/4	273	1796/1	438	1802/68	46	1806/17	263	1814/6	234	1820/3	242
1770/15	122	1782/5	273	1796/2	430	1802/69	46	1806/18	263	1814/7	249	1820/4	242
1770/16	122	1782/6	273	1796/3	41	1802/70	46	1806/19	263	1814/8	236	1820/5	240
1771/1	130	1782/7	273	1796/4	37	1802/71	46	1806/20	263	1814/9	234	1820/6	240
1771/2	128	1782/8	273	1796/5	37	1802/72	46	1806/21	263	1814/10	234	1820/7	240
1771/3	128	1782/9	273	1802/1	46	1802/73	46	1806/22	263	1814/11	234	1820/8	240
1771/4	123	1783/1	280	1802/2	46	1802/74	46	1806/23	263	1814/12	234	1820/9	239
1771/5	134	1783/2	280	1802/3	46	1802/75	46	1806/24	263	1814/13	249	1820/10	249
1771/6	124	1783/3	272	1802/4	46	1802/76	46	1806/25	263	1814/14	236	1820/11	242
1771/7	133	1783/4	272	1802/5	46	1802/77	46	1806/26	263	1814/15	234	1820/12	248
1771/8	123	1783/5	272	1802/6	46	1802/78	46	1806/27	263	1814/16	234	1820/13	248
1773/1	129	1783/6	272	1802/7	46	1802/79	46	1806/28	263	1814/17	234	1820/14	248
1773/2	129	1783/7	272	1802/8	46	1802/80	46	1806/29	263	1814/18	234	1822/1	234
1773/3	129	1783/8	272	1802/9	46	1802/81	46	1806/30	263	1817/1	234	1822/2	234
1773/4	129	1784/1	273	1802/10	46	1802/82	46	1807/1	263	1817/2	234	1822/3	234
1773/5	129	1784/2	273	1802/11	46	1802/83	46	1807/2	263	1817/3	234	1822/4	234
1773/6	129	1784/3	273	1802/12	46	1802/84	46	1807/3	263	1817/4	236	1822/5	243
1773/7	129	1784/4	273	1802/13	46	1802/85	46	1807/4	263	1817/5	234	1822/6	236
1773/8	129	1784/5	271	1802/14	46	1802/86	46	1807/5	263	1817/6	234	1822/7	238
1775/1	229	1784/6	271	1802/15	46	1802/87	46	1807/6	263	1817/7	236	1822/8	238
1775/2	229	1784/7	271	1802/16	46	1802/88	46	1807/7	263	1817/8	234	1822/9	249
1775/3	229	1784/8	271	1802/17	46	1802/89	46	1807/8	263	1817/9	234	1822/10	239
1775/4	229	1784/9	271	1802/18	46	1802/90	46	1807/9	263	1817/10	234	1822/11	249
1775/5	229	1785/1	284	1802/19	46	1802/91	46	1807/10	263	1817/11	236	1822/12	234
1775/6	229	1785/2	284	1802/20	46	1802/92	46	1807/11	263	1817/12	234	1822/13	234
1775/7	231	1785/3	284	1802/21	46	1802/93	46	1807/12	263	1818/1	244	1822/14	234
1775/8	231	1785/4	284	1802/22	46	1802/94	46	1807/13	263	1818/2	244	1822/15	234
1775/9	231	1785/5	284	1802/23	46	1802/95	46	1807/14	263	1818/3	244	1822/16	243
1775/10	229	1787/1	278	1802/24	46	1802/96	46	1807/15	263	1818/4	244	1822/17	236
1775/11	229	1787/2	278	1802/25	46	1802/97	46	1807/16	263	1818/5	238	1822/18	238

1822/19	238	1838/7	244	1842/9	268	1848/20	253	1853/1	306	1853/73	307	1853/145	305
1822/20	249	1838/7	256	1842/10	268	1848/21	253	1853/2	306	1853/74	307	1853/146	305
1822/21	239	1838/8	250	1842/11	268	1851/1	254	1853/3	306	1853/75	307	1853/147	305
1822/22	249	1839/1	256	1842/12	268	1851/2	254	1853/4	306	1853/76	307	1853/148	305
1825/1	244	1839/2	256	1842/13	268	1851/3	254	1853/5	306	1853/77	307	1853/149	305
1825/2	244	1839/3	256	1842/14	268	1851/4	254	1853/6	306	1853/78	307	1853/150	305
1825/3	244	1839/4	256	1842/15	268	1851/5	254	1853/7	306	1853/79	307	1853/151	305
1825/4	244	1839/5	267	1842/16	268	1851/6	254	1853/8	306	1853/80	307	1853/152	305
1825/5	244	1839/6	267	1842/17	268	1851/7	254	1853/9	306	1853/81	307	1853/153	305
1825/6	244	1839/7	261	1842/18	268	1851/8	254	1853/10	306	1853/82	307	1853/154	305
1825/7	244	1839/8	261	1842/19	268	1851/9	254	1853/11	306	1853/83	307	1853/155	305
1825/8	244	1839/9	261	1842/20	268	1851/10	254	1853/12	306	1853/84	307	1853/156	305
1825/9	242	1839/10	261	1842/21	268	1851/11	254	1853/13	306	1853/85	307	1853/157	305
1825/10	242	1839/11	261	1842/22	268	1851/12	254	1853/14	306	1853/86	307	1853/158	305
1825/11	242	1839/12	261	1842/23	268	1851/13	254	1853/15	306	1853/87	307	1853/159	308
1825/12	242	1839/13	261	1842/24	268	1851/14	255	1853/16	306	1853/88	307	1853/160	308
1825/13	240	1839/14	261	1842/25	268	1851/15	255	1853/17	306	1853/89	307	1853/161	308
1825/14	240	1839/15	256	1842/26	268	1851/16	255	1853/18	306	1853/90	307	1853/162	308
1825/15	240	1839/16	256	1842/27	268	1851/17	255	1853/19	306	1853/91	307	1853/163	308
1825/16	239	1839/17	256	1842/28	268	1851/18	255	1853/20	306	1853/92	307	1853/164	308
1825/17	249	1839/18	256	1842/29	268	1851/19	255	1853/21	306	1853/93	307	1853/165	308
1825/18	242	1839/19	256	1842/30	268	1851/20	255	1853/22	306	1853/94	307	1853/166	308
1825/19	242	1839/20	256	1842/31	268	1851/21	255	1853/23	306	1853/95	307	1853/167	308
1825/20	242	1839/21	256	1842/32	268	1851/22	255	1853/24	306	1853/96	307	1853/168	308
1825/21	242	1839/22	256	1842/33	268	1851/23	255	1853/25	306	1853/97	307	1853/169	308
1825/22	242	1839/23	256	1842/34	268	1851/24	255	1853/26	306	1853/98	307	1853/170	308
1825/23	240	1839/24	256	1845/1	303	1851/25	255	1853/27	306	1853/99	307	1853/171	308
1825/24	240	1839/25	250	1845/2	303	1851/26	254	1853/28	306	1853/100	307	1853/172	308
1825/25	240	1841/1	261	1845/3	303	1851/27	254	1853/29	306	1853/101	307	1853/173	308
1825/26	239	1841/2	261	1845/4	303	1851/28	254	1853/30	306	1853/102	307	1853/174	308
1825/27	249	1841/3	261	1845/5	303	1851/29	254	1853/31	306	1853/103	307	1853/175	308
1825/28	242	1841/4	261	1845/6	301	1851/30	254	1853/32	306	1853/104	307	1853/176	308
1827/1	352	1841/5	261	1845/7	301	1852/1	311	1853/33	306	1853/105	305	1853/177	308
1827/2	352	1841/6	261	1845/8	301	1852/2	311	1853/34	306	1853/106	305	1853/178	308
1827/3	352	1841/7	261	1845/9	301	1852/3	311	1853/35	306	1853/107	305	1853/179	308
1827/4	352	1841/8	260	1845/10	301	1852/4	311	1853/36	306	1853/108	305	1853/180	308
1827/5	352	1841/9	260	1845/11	304	1852/5	311	1853/37	306	1853/109	305	1853/181	308
1827/6	352	1841/10	260	1845/12	304	1852/6	311	1853/38	306	1853/110	305	1853/182	308
1827/7	352	1841/11	260	1845/13	304	1852/7	311	1853/39	306	1853/111	305	1853/183	308
1827/8	352	1841/12	260	1845/14	304	1852/8	311	1853/40	306	1853/112	305	1853/184	308
1827/9	352	1841/13	260	1845/15	304	1852/9	311	1853/41	306	1853/113	305	1853/185	308
1827/10	352	1841/14	260	1845/16	303	1852/10	311	1853/42	306	1853/114	305	1853/186	308
1827/11	352	1841/15	260	1845/17	303	1852/11	311	1853/43	306	1853/115	305	1853/187	308
1827/12	352	1841/16	260	1845/18	303	1852/12	311	1853/44	306	1853/116	305	1853/188	308
1834/1	264	1841/17	260	1845/19	303	1852/13	311	1853/45	306	1853/117	305	1853/189	308
1834/2	264	1841/18	260	1845/20	299	1852/14	311	1853/46	306	1853/118	305	1853/190	308
1834/3	264	1841/19	260	1845/21	299	1852/15	311	1853/47	306	1853/119	305	1853/191	308
1834/4	265	1841/20	260	1845/22	299	1852/16	311	1853/48	306	1853/120	305	1853/192	308
1834/5	264	1841/21	260	1845/23	299	1852/17	311	1853/49	306	1853/121	305	1853/193	308
1834/6	264	1841/22	260	1845/24	304	1852/18	311	1853/50	306	1853/122	305	1853/194	308
1834/7	265	1841/23	260	1845/25	304	1852/19	311	1853/51	307	1853/123	305	1853/195	309
1834/8	265	1841/24	260	1845/26	304	1852/20	311	1853/52	307	1853/124	305	1853/196	309
1834/9	264	1841/25	260	1845/27	304	1852/21	311	1853/53	307	1853/125	305	1853/197	309
1837/1	265	1841/26	260	1846/1	316	1852/22	311	1853/54	307	1853/126	305	1853/198	309
1837/2	265	1841/27	260	1846/2	398	1852/23	311	1853/55	307	1853/127	305	1853/199	309
1837/3	265	1841/28	260	1846/3	255	1852/24	311	1853/56	307	1853/128	305	1853/200	309
1837/4	265	1841/29	260	1846/4	255	1852/25	311	1853/57	307	1853/129	305	1853/201	309
1837/5	265	1841/30	261	1848/1	252	1852/26	311	1853/58	307	1853/130	305	1853/202	309
1837/6	265	1841/31	261	1848/2	252	1852/27	311	1853/59	307	1853/131	305	1853/203	309
1837/7	251	1841/32	261	1848/3	252	1852/28	311	1853/60	307	1853/132	305	1853/204	309
1837/8	251	1841/33	261	1848/4	252	1852/29	311	1853/61	307	1853/133	305	1853/205	309
1838/1	249	1841/34	261	1848/5	252	1852/30	311	1853/62	307	1853/134	305	1853/206	309
1838/2	244	1841/35	261	1848/6	252	1852/31	311	1853/63	307	1853/135	305	1853/207	309
1838/2	256	1841/36	261	1848/7	253	1852/32	311	1853/64	307	1853/136	305	1853/208	309
1838/3	244	1842/1	268	1848/8	253	1852/33	311	1853/65	307	1853/137	305	1853/209	309
1838/3	256	1842/2	268	1848/9	253	1852/34	311	1853/66	307	1853/138	305	1853/210	309
1838/4	244	1842/3	268	1848/10	253	1852/35	311	1853/67	307	1853/139	305	1853/211	309
1838/4	256	1842/4	268	1848/14	253	1852/36	311	1853/68	307	1853/140	305	1853/212	309
1838/5	244	1842/5	268	1848/16	253	1852/37	311	1853/69	307	1853/141	305	1853/213	309
1838/5	256	1842/6	268	1848/17	253	1852/38	311	1853/70	307	1853/142	305	1853/214	309
1838/6	244	1842/7	268	1848/18	253	1852/39	311	1853/71	307	1853/143	305	1853/215	309
1838/6	256	1842/8	268	1848/19	253	1852/40	311	1853/72	307	1853/144	305	1853/216	309

INDICE - INDEX

1853/217	309	1860/2	408	1870/3	525	3005/8	600	10314/6	476	GD20/3	168	GD69/2	87
1853/218	309	1860/3	408	1871/1	535	3005/26	597	10314/7	476	GD20/4	168	GD70/1	97
1853/219	309	1860/4	408	1871/2	535	3005/33	599	10314/8	476	GD20/5	168	GD71/1	97
1853/220	309	1860/5	408	1871/3	535	3005/55	598	10315/1	475	GD20/6	168	GD72/1	97
1853/221	309	1860/6	408	1871/4	535	3005/56	599	10315/2	475	GD20/7	168	GD73/1	97
1853/222	309	1861/1	408	1871/5	535	3005/65	598	10315/3	475	GD20/8	168	GD73/2	180
1853/223	309	1861/2	408	1871/6	535	3005/70	596	10315/4	476	GD21/1	102	GD73/2	165
1853/224	309	1861/3	408	1871/7	535	3005/71	600	10315/6	475	GD21/2	102	GD73/3	165
1853/225	309	1861/4	408	1872/1	532	3005/73	600	10316/2	476	GD21/3	168	GD73/4	468
1853/226	309	1861/5	408	1872/2	533	3005/75	599	10316/3	476	GD21/4	168	GD76/1	83
1853/227	309	1861/6	408	1872/3	533	5069/3	474	10316/4	476	GD21/5	168	GD76/2	83
1853/228	309	1861/7	408	1872/4	534	6016/1	357	10316/5	476	GD21/6	168	GD77/1	50
1853/229	309	1861/8	408	1872/5	534	6036/8	24	10316/7	476	GD21/7	168	GD78/1	100
1853/230	309	1861/9	408	1872/6	532	6048/1	355	10316/8	476	GD22/1	169	GD78/2	100
1854/1	365	1861/10	408	1872/7	534	6048/2	355	10333/1	491	GD22/2	169	GD78/3	100
1854/2	365	1861/11	408	1872/8	531	6048/3	355	10393/1	477	GD22/3	169	GD86/1	113
1854/3	365	1861/12	408	1872/9	531	6048/5	347	10393/2	477	GD22/4	169	GD86/1	273
1854/4	380	1861/13	408	1872/10	533	6092/1	290	10393/3	477	GD22/5	169	GD88/1	100
1854/5	380	1861/14	408	1872/11	532	6092/2	290	10393/4	477	GD22/6	225	GD88/2	100
1854/6	380	1861/15	408	1872/12	533	6092/3	290	10393/5	477	GD23/1	178	GD92/1	184
1854/7	395	1861/16	408	1872/13	533	6092/4	40	10393/6	477	GD25/1	178	GD92/2	173
1854/8	395	1861/17	408	1872/14	534	6092/4	290	10393/7	477	GD25/2	178	GD92/3	173
1854/9	395	1861/18	408	1872/15	534	6092/5	290	10393/8	477	GD25/3	178	GD99/1	107
1855/1	387	1861/19	408	1872/16	532	6096/1	41	10393/9	477	GD26/1	92	GD102/1	107
1855/2	387	1861/20	408	1872/17	534	6108/1	38	10393/10	477	GD29/1	178	GD105/1	107
1855/3	387	1861/21	408	1872/18	531	6112/2	290	10393/11	477	GD29/2	178	GD106/1	141
1855/4	389	1861/22	408	1872/19	531	6112/4	40	10393/12	477	GD31/1	87	GD106/2	141
1855/5	389	1864/1	498	1872/20	533	6112/4	290	10395/1	477	GD31/2	87	GD106/3	141
1855/6	395	1864/2	498	1875/1	552	6115/1	37	10395/2	477	GD35/1	166	GD106/4	141
1855/7	395	1864/3	498	1875/2	554	6131/1	41	10395/3	477	GD35/2	166	GD106/5	141
1855/8	395	1864/4	498	1875/3	553	6214/1	42	10395/4	477	GD35/3	166	GD106/6	141
1855/9	395	1864/5	501	1875/4	554	6318/1	482	10395/5	477	GD35/4	142	GD106/7	141
1855/10	395	1864/6	500	1875/5	552	6320/1	485	10395/6	477	GD38/1	92	GD106/8	141
1855/11	331	1864/7	501	1875/6	552	6321/1	485	10395/7	477	GD38/2	92	GD106/9	141
1855/12	331	1864/8	500	1875/7	553	6322/1	484	10395/8	477	GD39/1	94	GD106/10	141
1855/13	331	1864/9	499	1875/8	553	6324/1	484	10395/9	477	GD39/2	94	GD106/11	141
1855/14	331	1864/10	499	1875/9	551	6326/1	485	10395/10	477	GD39/3	94	GD106/12	141
1855/15	331	1864/11	501	1875/10	551	6327/1	485	10395/11	477	GD40/1	102	GD106/13	141
1855/16	331	1864/12	500	1875/11	552	6340/1	482	10395/12	477	GD41/1	179	GD106/14	141
1855/17	331	1864/13	501	1875/12	554	6342/1	486	10437/1	492	GD41/2	94	GD106/15	141
1855/18	331	1864/14	500	1875/13	553	6343/1	486	10455/1	492	GD42/1	102	GD106/16	141
1855/19	331	1864/15	501	1875/14	554	6344/1	483	10472/1	493	GD42/2	94	GD106/17	141
1855/20	331	1864/16	500	1875/15	552	6346/1	483	10472/2	493	GD43/1	173	GD106/18	141
1855/21	331	1864/17	499	1875/16	552	6348/1	486	10473/1	493	GD45/1	94	GD106/19	141
1855/22	331	1864/18	499	1875/17	553	6349/1	486	10473/2	493	GD45/2	94	GD106/20	141
1855/23	330	1864/19	501	1875/18	553	6352/1	487	10474/1	493	GD47/1	93	GD106/21	141
1855/24	330	1864/20	500	1875/19	551	6352/2	487	10475/1	493	GD47/2	92	GD106/22	141
1855/25	330	1865/1	506	1875/20	551	6352/3	326	10475/2	493	GD47/3	93	GD106/23	141
1855/26	330	1865/2	506	1905/1	465	6352/3	488	10477/1	493	GD47/4	93	GD106/24	141
1857/1	437	1865/3	506	1905/2	465	6352/4	326	10477/2	493	GD48/1	184	GD106/25	141
1857/2	427	1865/4	506	1905/3	465	6352/4	488	10520/1	491	GD48/2	184	GD106/26	141
1857/3	427	1865/5	506	1905/4	465	6353/1	487	10539/1	492	GD50/1	92	GD106/27	141
1857/4	427	1867/1	523	1905/5	465	6353/2	487	10540/1	492	GD58/1	86	GD111/1	343
1857/5	408	1867/2	523	1905/6	465	6354/1	487	GD12/1	179	GD58/2	178	GD124/1	304
1857/6	408	1867/3	523	1905/7	465	6354/2	487	GD13/1	226	GD58/3	178	GD124/2	304
1857/7	408	1867/4	521	1905/8	465	6355/1	488	GD15/1	84	GD59/1	179	GD124/3	304
1857/8	408	1867/5	521	1905/9	465	6355/2	488	GD15/2	84	GD59/2	179	GD124/4	304
1857/9	436	1867/6	521	1905/10	465	6355/3	326	GD15/3	84	GD59/3	178	GD124/5	304
1857/10	436	1867/7	52	1905/12	465	6355/3	488	GD16/1	84	GD59/4	178	GD124/6	304
1857/11	436	1869/1	524	1905/13	465	6355/4	326	GD16/2	84	GD61/1	95	GD124/7	304
1857/12	436	1869/2	524	1905/14	465	6355/4	488	GD17/1	84	GD64/1	143	GD124/8	304
1857/13	405	1869/3	524	1905/15	465	6356/1	488	GD17/1	179	GD64/2	143	GD124/9	300
1857/14	405	1869/4	524	1905/16	465	6356/2	488	GD18/1	174	GD64/3	143	GD124/10	300
1857/15	405	1869/5	524	1905/17	465	6356/3	326	GD18/2	174	GD64/4	143	GD124/11	300
1858/1	379	1869/6	527	1905/18	465	6356/3	488	GD18/3	179	GD66/1	92	GD124/12	300
1858/2	379	1869/7	527	1905/19	465	6356/4	326	GD18/4	174	GD66/2	93	GD124/13	300
1858/3	379	1869/8	527	3002/6	41	6356/4	488	GD19/1	174	GD66/3	92	GD124/14	300
1858/4	379	1869/9	527	3002/6	290	10314/1	475	GD19/2	174	GD67/1	92	GD124/15	300
1858/5	379	1869/10	528	3002/7	41	10314/2	475	GD19/3	179	GD68/1	97	GD124/16	300
1858/6	379	1869/11	536	3002/7	290	10314/3	475	GD19/4	174	GD68/2	167	GD124/17	259
1858/7	379	1870/1	525	3002/13	383	10314/4	475	GD20/1	179	GD68/3	180	GD124/18	259
1860/1	408	1870/2	525	3005/2	598	10314/5	476	GD20/2	179	GD69/1	87	GD124/19	259

INDICE - INDEX

GD124/20	259	GD128/60	312	GD189/1	91	GD239/1	106	NEW0021	150	PC6/3	211	PC57/2	219
GD124/21	259	GD128/61	312	GD189/2	91	GD239/2	180	NEW0022	150	PC6/4	211	PC58/1	219
GD124/22	259	GD128/62	312	GD190/1	167	GD239/3	180	NEW0023	150	PC6/5	211	PC58/2	219
GD124/23	259	GD128/63	312	GD190/2	167	GD239/4	421	NEW0024	165	PC6/6	211	PC58/3	219
GD124/24	259	GD128/64	312	GD191/1	167	GD239/5	421	NEW0025	165	PC8/1	211	PC60/1	220
GD124/25	259	GD148/1	170	GD191/2	167	GD240/1	98	NEW0026	276	PC8/2	211	PC60/2	220
GD124/26	259	GD150/1	170	GD192/1	167	GD240/2	17	NEW0027	276	PC8/3	211	PC60/3	220
GD124/27	259	GD150/2	170	GD192/2	167	GD241/1	98	NEW0028	231	PC8/4	211	PC60/4	220
GD124/28	259	GD150/3	170	GD192/3	171	GD241/2	98	NEW0029	150	PC8/5	211	PC60/5	220
GD124/29	259	GD151/1	170	GD193/1	171	GD242/1	86	NEW0030	150	PC8/6	211	PC60/6	220
GD124/30	259	GD151/2	61	GD195/1	153	GD243/1	178	NEW0031	150	PC10/1	211	PC60/7	220
GD124/31	259	GD152/1	180	GD195/2	153	GD243/2	178	NEW0032	150	PC10/2	211	PC60/8	220
GD124/32	259	GD152/2	180	GD195/3	153	GD245/1	99	NEW0033	150	PC10/3	211	PC60/9	220
GD128/1	313	GD153/1	167	GD195/4	153	GD245/2	99	NEW0034	150	PC10/4	211	PC60/10	220
GD128/2	313	GD153/2	101	GD195/5	153	GD245/3	99	NEW0035	165	PC12/1	211	PC60/16	220
GD128/3	313	GD153/3	101	GD195/6	153	GD247/1	104	NEW0036	165	PC16/1	215	PC60/17	220
GD128/4	313	GD154/1	170	GD195/7	153	GD247/2	184	NEW0037	276	PC16/2	215		
GD128/5	313	GD154/2	170	GD196/1	177	GD247/3	184	NEW0038	276	PC18/1	212		
GD128/6	313	GD154/3	170	GD196/2	177	GD248/1	128	NEW0039	231	PC18/2	212		
GD128/7	313	GD156/1	171	GD196/3	177	GD248/2	128	NEW0040	163	PC18/3	212		
GD128/8	313	GD156/2	171	GD199/1	153	GD249/1	188	NEW0041	163	PC19/1	212		
GD128/9	313	GD158/1	172	GD199/2	153	GD249/2	188	NEW0042	163	PC19/2	212		
GD128/10	313	GD158/2	172	GD199/3	153	GD251/1	188	NEW0043	163	PC20/1	213		
GD128/11	313	GD159/1	99	GD199/4	153	GD251/2	188	NEW0044	163	PC22/1	213		
GD128/12	313	GD159/2	99	GD199/5	153	GD251/3	188	NEW0045	163	PC22/2	213		
GD128/13	313	GD161/1	95	GD199/6	153	GD251/4	188	NEW0046	165	PC22/3	213		
GD128/14	313	GD161/2	95	GD199/7	153	GD253/1	89	NEW0047	165	PC22/4	213		
GD128/15	313	GD161/3	95	GD200/1	177	GD253/2	89	NEW0048	165	PC22/5	213		
GD128/16	313	GD163/1	104	GD200/2	177	GD255/1	89	NEW0049	407	PC24/1	214		
GD128/17	313	GD163/2	104	GD200/3	177	GD255/2	89	NEW0049	427	PC26/1	213		
GD128/18	313	GD164/1	85	GD202/1	101	GD262/1	18	NEW0050	407	PC28/1	214		
GD128/19	313	GD164/2	85	GD205/1	101	GD262/2	18	NEW0050	427	PC28/2	214		
GD128/20	313	GD166/1	105	GD205/2	101	GD262/3	18	NEW0051	407	PC28/3	214		
GD128/21	313	GD166/2	95	GD206/1	108	GD262/4	18	NEW0052	407	PC28/4	214		
GD128/22	313	GD167/1	171	GD206/2	108	GD263/1	18	NEW0053	427	PC28/5	214		
GD128/23	313	GD169/1	99	GD209/1	108	GD263/2	18	NEW0054	407	PC28/6	214		
GD128/24	313	GD169/2	99	GD209/2	108	GD263/3	18	NEW0054	427	PC28/7	214		
GD128/25	313	GD169/3	170	GD209/3	108	GD264/1	17	NEW0055	407	PC30/1	214		
GD128/26	313	GD170/1	171	GD211/1	96	GD264/1	290	NEW0055	427	PC30/2	214		
GD128/27	313	GD170/2	171	GD211/2	50	GD264/2	17	NEW0056	427	PC32/1	213		
GD128/28	313	GD171/1	167	GD211/2	60	GD264/2	290	NEW0057	427	PC33/1	213		
GD128/29	313	GD173/1	103	GD211/3	96	GD264/3	17	NEW0058	417	PC33/2	213		
GD128/30	313	GD173/2	103	GD211/4	96	GD264/3	290	NEW0059	427	PC34/1	215		
GD128/31	313	GD173/3	103	GD212/1	96	GD264/4	17	NEW0060	25	PC34/2	215		
GD128/32	313	GD173/4	103	GD215/1	83	GD264/4	290	NEW0061	25	PC34/3	215		
GD128/33	313	GD175/1	180	GD215/2	180	GD264/5	17	NEW0062	25	PC34/4	215		
GD128/34	313	GD175/2	180	GD215/3	83	GD264/5	290	NEW0063	22	PC38/1	216		
GD128/35	313	GD175/3	180	GD216/1	107	GD265/1	368	NEW0064	22	PC38/2	216		
GD128/36	313	GD175/4	180	GD216/2	107	GD265/2	368	NEW0065	22	PC38/3	216		
GD128/37	313	GD175/5	180	GD216/3	107	GD265/3	368	NEW0066	22	PC40/1	216		
GD128/38	313	GD175/6	180	GD219/1	98	GD265/4	368	NEW0067	22	PC42/1	216		
GD128/39	313	GD175/7	103	GD219/2	98	GD265/5	368	NEW0068	22	PC42/2	216		
GD128/40	313	GD176/1	173	GD219/3	98	NEW0001	58	NEW0069	22	PC44/1	216		
GD128/41	313	GD176/2	173	GD220/1	105	NEW0002	58	NEW0070	22	PC44/2	216		
GD128/42	313	GD176/3	173	GD220/2	105	NEW0003	58	NEW0071	22	PC45/1	217		
GD128/43	313	GD177/1	105	GD222/1	85	NEW0004	54	NEW0072	22	PC45/2	217		
GD128/44	313	GD177/2	105	GD222/2	85	NEW0005	58	NEW0073	22	PC46/1	217		
GD128/45	313	GD178/1	172	GD223/1	85	NEW0006	60	NEW0074	22	PC47/1	217		
GD128/46	313	GD178/2	172	GD225/1	103	NEW0007	60	NEW0077	358	PC48/1	217		
GD128/47	313	GD181/1	90	GD226/1	180	NEW0008	60	NEW0078	358	PC49/1	215		
GD128/48	313	GD181/2	90	GD226/2	180	NEW0009	61	NEW0079	358	PC49/2	215		
GD128/49	312	GD181/3	90	GD226/3	103	NEW0010	61	NEW0080	358	PC50/1	217		
GD128/50	312	GD182/1	90	GD226/4	180	NEW0011	61	NEW0081	358	PC52/1	217		
GD128/51	312	GD182/2	90	GD228/1	103	NEW0012	25	NEW0082	358	PC52/2	217		
GD128/52	312	GD183/1	90	GD228/2	172	NEW0013	353	PC4/1	211	PC54/1	218		
GD128/53	312	GD184/1	90	GD231/1	105	NEW0014	353	PC4/2	211	PC55/1	218		
GD128/54	312	GD184/2	90	GD231/2	105	NEW0015	353	PC4/3	211	PC55/2	218		
GD128/55	312	GD186/1	91	GD232/1	86	NEW0016	61	PC4/4	211	PC55/3	218		
GD128/56	312	GD186/2	91	GD233/1	86	NEW0017	172	PC4/5	211	PC56/1	219		
GD128/57	312	GD186/3	91	GD234/1	104	NEW0018	150	PC4/6	211	PC56/2	219		
GD128/58	312	GD187/1	91	GD235/1	104	NEW0019	150	PC6/1	211	PC56/3	219		
GD128/59	312	GD187/2	61	GD236/1	106	NEW0020	150	PC6/2	211	PC57/1	219		



E001	556	E0069101316	566	E0069999	567	E00872	569	E0118	572	E01212	572	E02051316	584
E001/6000	556	E006910316	566	E00700	568	E00880	571	E01181	572	E0122	574	E02052316	560
E0011	556	E006911	566	E00700316	568	E00880316	571	E01181316	572	E0123	574	E02052316	585
E0011/6000	556	E006911316	566	E00710	568	E00881	571	E01182	572	E0124	574	E0205316	560
E00152020	556	E006913	566	E00710316	568	E00881316	571	E01182316	572	E0125	574	E02061	560
E00152020	585	E006917	566	E00720	568	E00882	571	E01183	572	E0126	574	E02061316	560
E00202525	556	E00692	566	E00720316	568	E00882316	571	E0118316	572	E01261	574	E02062	560
E00202525	585	E006921	566	E0073	568	E00883	571	E01183316	572	E01262	574	E02062316	560
E00203030	556	E00692100	566	E00730	569	E00883316	571	E0119	572	E0127	574	E02063	560
E00203030	585	E006922	566	E0073316	568	E00891	571	E0119010	573	E0128	574	E02063316	560
E00204040	556	E00692200	566	E00736	569	E00891316	571	E0119020	573	E01281	574	E02064	560
E00204040	585	E006923	566	E00736	569	E00892	571	E0119110	573	E0129	574	E02064316	560
E00205050	556	E00692300	566	E00737	569	E00892316	571	E0119120	573	E01292	574	E02065	560
E00205050	585	E006924	566	E00737	569	E00893	571	E01192	564	E013	557	E02065316	560
E00206060	556	E00693	566	E00738	569	E00893316	571	E0119210	573	E0130	574	E02066	560
E00206060	585	E00693000	566	E00738	569	E00895	571	E0119220	573	E0130/SO	574	E02066316	560
E0040	586	E006931	566	E0074	568	E00895316	571	E01192316	564	E01300	574	E02067	560
E0040316	586	E00693100	566	E00740	569	E00896	571	E01193	563	E01301	574	E02067316	560
E0042	586	E006931316	566	E007401	569	E00896316	571	E011931	563	E01301/SO	574	E02068	560
E00421	586	E00693200	566	E00741	569	E00897	571	E0119310	573	E01302	574	E02068316	560
E00421316	586	E00693300	566	E00742	569	E00897316	571	E011931316	563	E0131	557	E021/S	563
E00422	586	E00693316	566	E00743	569	E009	568	E0119320	573	E01316	567	E021/S316	563
E00422316	586	E006934	566	E0074316	568	E0091	568	E01193316	563	E014	557	E0210	563
E0042316	586	E006934316	566	E0075	568	E00911	568	E01194	563	E0141	557	E0210316	563
E00450	586	E006935	566	E00750	569	E00912	568	E011940	564	E015	559	E02111	572
E004501	586	E006935316	566	E00751	569	E00913	568	E011940316	564	E016	559	E02112	572
E004501316	586	E00694	567	E00752	569	E0092	568	E011941	563	E01651	567	E0212	556
E00450316	586	E006941	567	E0075316	568	E00921	568	E0119410	573	E01652	567	E021200	556
E005	556	E006941316	567	E0076	568	E0093	568	E011941316	563	E01653	567	E021200316	556
E005/6000	556	E00694316	567	E00760	569	E00931	568	E0119420	573	E01654	567	E0212316	556
E0050	556	E00695	567	E00762	569	E00941	568	E011943	563	E017	559	E0213	556
E0050/6000	556	E00695316	567	E0076316	568	E00950	569	E01194316	563	E0170	568	E021310	556
E0051	556	E00696	566	E0077	568	E00952	569	E011943316	563	E0170316	568	E021310316	556
E0051/6000	556	E00696100	567	E0077316	568	E00955	569	E011944	563	E0171	568	E021320	556
E0052	556	E00696200	567	E0078	568	E00957	569	E0119441	564	E0171316	568	E021320316	556
E0052/6000	556	E00696300	567	E0078316	568	E00960	568	E0119441316	564	E0172	568	E021330	556
E006	566	E00696400	567	E0079	568	E00962	568	E011944316	563	E0172316	568	E021330316	556
E00600	567	E006965	566	E00791	568	E00970	568	E011945	564	E018	559	E0213316	556
E0061	566	E00696500	567	E00791316	568	E00971	568	E0119451	564	E0180	559	E02195/122	572
E00610	567	E006966	566	E00792	568	E00973	568	E0119451316	564	E0180316	559	E02195100	563
E00611	567	E006966316	566	E00792316	568	E00980	568	E011945316	564	E0181	559	E02195100	572
E0062	566	E00697	566	E0079316	568	E00981	568	E011946	564	E0181316	559	E02196/122	572
E00620	567	E00697100	567	E00820	571	E00983	568	E011946316	564	E0182	559	E02196100	563
E00620316	567	E00697110	567	E00820316	571	E0099	570	E011947	564	E0183	559	E02196100	572
E00621	567	E00697200	567	E00821	571	E0099100	570	E011947316	564	E0184	559	E022/S1	560
E00621316	567	E00697210	567	E00821316	571	E01	567	E011948	564	E0184316	559	E022/S1316	560
E00622	567	E006976	566	E00830	571	E010	573	E011948316	564	E019	559	E022/S2	560
E00622316	567	E006976316	566	E00830316	571	E0101	573	E01195	572	E0191	559	E022/S2316	560
E0063	566	E006977	566	E00831	571	E0102	562	E01195/122	572	E0191316	559	E0221	560
E006316	566	E006977316	566	E00831316	571	E010206040	583	E01195100	563	E0192	559	E02211	572
E0063316	566	E006978	566	E00840	570	E0102316	562	E01195100	572	E0192316	559	E02212	572
E0064	566	E00698	571	E00840/C	570	E0103	562	E01196	572	E019316	559	E0222	560
E0064316	566	E00698100	566	E00840/R1	570	E0103316	562	E01196/122	572	E02	567	E0222316	560
E0065	566	E00698200	566	E00840/R2	570	E0104	562	E01196100	563	E020	559	E0223	560
E00651	567	E00698300	566	E00840/R3	570	E0104316	562	E01196100	572	E020/C	559	E02231	560
E00652	567	E00698400	566	E00840/R4	570	E0105	562	E01197	563	E020/S	559	E02231316	560
E0065316	566	E00699	571	E00840/R5	570	E0105316	562	E011971	563	E0201	559	E0223316	560
E00654	567	E00699100	566	E00841	570	E011	572	E011971316	563	E0201/C	559	E0224	560
E0066	566	E00699200	566	E00842	570	E0111	572	E01197316	563	E02011	559	E0224	581
E0066316	566	E00699300	566	E00843	570	E01111	572	E011974	563	E0202	559	E02241	560
E00666	566	E00699400	566	E00850	569	E01112	572	E011974316	563	E0203	559	E02241316	560
E0067	566	E006999	567	E00851	569	E0111316	572	E011976	563	E0204	559	E0224316	560
E0068	566	E0069990	567	E00852	569	E011316	572	E011976316	563	E0205	560	E0225	563
E0069	566	E0069991	567	E00860	569	E0115	572	E012	574	E02050	585	E0225316	563
E00691	566	E0069993	567	E00861	569	E01151	572	E0120	574	E02050316	585	E0226	563
E006910	566	E0069994	567	E00862	569	E01157	572	E01201	574	E02051	585	E0226316	563
E0069100	566	E0069996	567	E00870	569	E01158	572	E0121	574	E02051	585	E02316	567
E0069101	566	E0069997	567	E00871	569	E0117	572	E01211	572	E02051316	560	E024	565

INDICE ARTEFERRO INOX / INDEX

E0241	565	E040	573	E0631316/5	559	E077	574	E10205030	585	E16203020	585	E40020	557
E03	567	E040000	561	E063316	558	E078	574	E10205050	556	E16203030	556	E40020/304	557
E030	561	E040010	561	E064	558	E080	564	E10205050	585	E16203030	585	E401	557
E030/S	561	E040100	561	E064316	558	E081	564	E10206040	556	E16204020	556	E401/304	557
E030/S316	561	E040110	561	E065	558	E08110	559	E10206040	585	E16204020	585	E4010406	556
E0301	561	E040200	562	E065316	558	E08110316	559	E10206060	556	E16204030	556	E40110	557
E0301316	561	E040210	562	E066	558	E08120	559	E10206060	585	E16204030	585	E40110/304	557
E031	562	E040300	562	E066316	558	E08120316	559	E1100000	584	E16204040	556	E40120	557
E031/S1	561	E040310	562	E0680	558	E08150	559	E1100100	584	E16204040	585	E40120/304	557
E031/S1316	561	E040400	562	E0680316	558	E08150316	559	E1100110	584	E16205030	556	E403	556
E0311	561	E040410	562	E0681	558	E08160	559	E1100424	584	E16205030	585	E4030	571
E0311316	561	E040500	562	E0681316	558	E08160316	559	E1100483	584	E16205050	556	E4030/304	571
E03316	567	E040510	562	E0682	558	E082	564	E111	557	E16205050	585	E4031	571
E034100	560	E040600	562	E0682316	558	E08210	559	E111/337	557	E16206040	556	E4031/304	571
E034100316	560	E040610	562	E0683	558	E08210316	559	E111/337316	557	E16206040	585	E4032	571
E037100	585	E040700	562	E0683316	558	E08220	559	E1110	557	E16206060	556	E4032/304	571
E037110	585	E040710	562	E069	558	E08220316	559	E1110316	557	E16206060	585	E403304	556
E037200	585	E040800	562	E0690	558	E08250	559	E1111	557	E1700200	582	E404	556
E037210	585	E040810	562	E0690/5	559	E08250316	559	E1111316	557	E1700300	582	E4040	566
E037500	585	E040900	562	E0690316/5	559	E08260	559	E1112	557	E170500	582	E4042	566
E037510	585	E040910	562	E0691	558	E08260316	559	E1112316	557	E1700600	582	E40422100	566
E037600	585	E041	573	E0691/D	558	E083	564	E1113	557	E1700700	582	E40422200	566
E037610	585	E041000	562	E0691316	558	E08310	559	E111316	557	E1800100	583	E40422300	566
E038000	561	E041010	562	E0691316/D	558	E08310316	559	E1113316	557	E1800200	583	E40423000	566
E038010	561	E041100	562	E06913316	566	E08320	559	E1114	557	E1800300	583	E40423100	566
E038100	561	E041110	562	E0693	558	E08320316	559	E1114316	557	E1800400	583	E40423200	566
E038110	561	E041200	562	E069316	558	E08350	559	E112	557	E1800500	583	E40423300	566
E038200	561	E041210	562	E0693316	558	E08350316	559	E112/70	557	E1800600	583	E40426100	567
E038210	561	E041300	562	E0695	558	E08360	559	E112/70316	557	E1800610	583	E40426200	567
E038300	561	E041310	562	E0695/5	559	E08360316	559	E112316	557	E1800620	583	E40426300	567
E038310	561	E041400	563	E0695/D	558	E084	564	E113	557	E1800700	583	E40426400	567
E038400	561	E041410	563	E0695316/5	559	E08410	559	E113/337	557	E1800710	583	E40426500	567
E038410	561	E041500	563	E0696	558	E08410316	559	E113/337316	557	E1800720	583	E40427110	567
E038500	561	E041510	563	E0696/D	558	E08420	559	E11310	558	E1800800	583	E40427210	567
E038510	561	E04316	567	E06961	558	E08420316	559	E11310316	558	E1999100	584	E40428100	566
E038600	561	E05	567	E06961/D	558	E08450	559	E11320	558	E1999200	584	E40428200	566
E038610	561	E050	558	E0698	558	E08450316	559	E11320316	558	E1999300	584	E40428300	566
E038700	561	E050100	562	E070	574	E08460	559	E113316	557	E1999400	584	E40428400	566
E038710	561	E050110	562	E070/GO	574	E08460316	559	E11340	558	E1999500	584	E40429100	566
E038800	561	E050200	562	E070/HP	574	E085	564	E11340	585	E1999650	584	E40429200	566
E038810	561	E050210	562	E0701	574	E08510	559	E11340316	558	E2000100	571	E40429300	566
E038900	561	E050300	562	E0701/GO	574	E08510316	559	E11340316	584	E2000200	571	E40429400	566
E038910	561	E050310	562	E0701/HP	574	E08520	559	E11410	557	E2001	564	E404304	556
E039	574	E051	558	E0701/HP	579	E08520316	559	E11410316	557	E2011	564	E4044	566
E039000	561	E051100	563	E0702	574	E08550	559	E11420	557	E2015	564	E40440	566
E039010	561	E051110	563	E0702/GO	574	E08550316	559	E11420316	557	E2016	564	E40445	566
E0391	574	E051200	563	E0702/HP	574	E08560	559	E11440	557	E2019	564	E40490	566
E039100	561	E051210	563	E0702/HP	579	E08560316	559	E11440316	557	E2021	573	E40491	566
E039110	561	E05316	567	E071	574	E086	564	E11510	557	E203	565	E40492	566
E0392	574	E060	558	E071/GO	574	E08610	559	E11510316	557	E2031	565	E40493	566
E039200	561	E0600	558	E071/HP	574	E08610316	559	E11520	557	E2034	565	E405	557
E039210	561	E0600316	558	E071/HP	579	E08620	559	E11520316	557	E2036	565	E40500	571
E0393	574	E060316	558	E072	574	E08620316	559	E116	557	E2041	565	E40550	571
E039300	561	E061	558	E072/HP	574	E08650	559	E116316	557	E2045	565	E40550304	571
E039310	561	E06152020	556	E072/HP	579	E08650316	559	E117	558	E2046	565	E40560	571
E0394	574	E06152020	585	E072304	574	E08660	559	E1200100	584	E2049	565	E40560304	571
E039400	561	E06202525	556	E073	574	E08660316	559	E1200110	584	E205	565	E40570	571
E039410	561	E06202525	585	E073/GO	574	E10152020	556	E1300100	584	E2061	565	E40570304	571
E0395	574	E06203030	556	E073/HP	574	E10152020	585	E1300110	584	E2062	565	E40581	571
E039500	561	E06203030	585	E073/HP	579	E10202525	556	E1400100	584	E2066	557	E40583	571
E039510	561	E06204040	556	E074	574	E10202525	585	E1400110	584	E2100100	571	E406	557
E0396	574	E06204040	585	E074/HP	574	E10203020	556	E1500100	584	E2100200	571	E40600	567
E039600	561	E06205050	556	E074/HP	579	E10203020	585	E1500110	584	E2200100	571	E40610	567
E039610	561	E06205050	585	E075	574	E10203030	556	E1600100	582	E2200200	571	E40611	567
E0397	574	E06206060	556	E075/GO	574	E10203030	585	E1600500	582	E315	573	E40651	567
E039700	561	E06206060	585	E075/HP	574	E10204020	556	E1600600	582	E316	573	E40652	567
E039710	561	E061316	558	E075/HP	579	E10204020	585	E1600700	582	E400	557	E40654	567
E039800	561	E062	558	E075304	574	E10204030	556	E16152020	556	E400/304	557	E4070	559
E039810	561	E062316	558	E076	574	E10204030	585	E16152020	585	E40000/SO	571	E4071	559
E039900	561	E063	558	E076/GO	574	E10204040	556	E16202525	556	E4000406	556	E4072	559
E039910	561	E0631	558	E076/HP	574	E10204040	585	E16202525	585	E40010	557	E4072/C	559
E04	567	E0631/5	559	E076/HP	579	E10205030	556	E16203020	556	E40010/304	557	E4072/S	559

INDICE ARTEFERRO INOX INDEX

E4073	559	E451	564	E4850	556	E911510	574	EM2331207F	586	ESF063316	576	EW1100424G	584
E40731	559	E451/304	564	E4850/6000	556	E9120	574	EM2331207S	586	ESF08	576	EW120010	584
E4074	559	E452	573	E4851	556	E912010	574	EM2421205F	586	ESF081	576	I001	556
E4075	559	E453	565	E4851/6000	556	E9125	574	EM2421205S	586	ESF081316	576	I001/6000	556
E4076	559	E453/40	565	E4852	556	E912510	574	EM2421207F	586	ESF083	576	I0011	556
E4077	559	E4540	563	E4852/6000	556	E9130	574	EM2421207S	586	ESF08316	576	I0011/6000	556
E4090	573	E4541	563	E500/424	562	E913010	574	EM4331205F	586	ESF083316	576	I0040	584
E40956	573	E455	565	E510/424	562	E99P8	570	EM4331205S	586	EST041DX	576	I0042	584
E4100	572	E455100	565	E600	581	E99P10	570	EM4331207F	586	EST041SX	576	I00421	584
E4110	572	E455200	565	E600/DI	581	E99P12	570	EM4331207S	586	EST043DX	576	I00422	584
E4115	572	E456	557	E600/T	581	E99P16	570	EM4421205F	586	EST043SX	576	I00450	584
E4116	572	E4560	557	E600/T/D	581	E99P20	570	EM4421205S	586	EST04DX	576	I00451	584
E4120	572	E4561	557	E601	581	E9933P8	570	EM4421207F	586	EST04SX	576	I005	556
E4130	572	E4565	557	E602	581	E9933P10	570	EM4421207S	586	EST051DX	576	I005/6000	556
E4139	572	E4566	557	E603	581	E9933P12	570	EL2420000F3K	588	EST051SX	576	I0051	556
E4141	572	E457	573	E604	581	E9942P8	570	EL2420000S3K	588	EST053DX	576	I0051/6000	556
E4143	572	E4571	573	E605	581	E9942P10	570	EL4420000F3K	588	EST053SX	576	I006	566
E4144	572	E458	562	E6070	581	E9942P12	570	EL4420000S3K	588	EST05DX	576	I00600	567
E41451	572	E458/40	562	E608	581	E9942P16	570	EM2420000F3K	588	EST05SX	576	I0061	566
E4146	572	E4581	562	E690	580	E9942P20	570	EM2420000S3K	588	ET06	575	I0062	566
E4148	572	E4581/40	562	E690/3000	580	E9950P8	570	EM4420000F3K	588	ETF04DX	575	I00620	567
E4149	572	E4583	563	E690/3000/G	580	E9950P10	570	EM4420000S3K	588	ETF04SX	575	I00621	567
E4150	574	E4583/424	563	E690/D	558	E9950P12	570	EP23302PF	587	ETF05DX	575	I0063	566
E4151	574	E4584	563	E690/G	580	E9950P16	570	EP23302PF	587	ETF05SX	575	I0064	566
E4152	574	E4584/424	563	E691	580	E9950P20	570	EP23304PF	587	ETF06DX	575	I0065	566
E4153	574	E4586	560	E691/3000	580	EA04	575	EP23304PS	587	ETF06SX	575	I00651	567
E4154	574	E4586	581	E692	580	EA04316	575	EP24202PF	587	ETFF04	575	I00654	567
E4155	574	E459	560	E692/3000	580	EA05	575	EP24202PS	587	ETFF05	575	I00666	566
E4160	574	E460	573	E695/1	580	EA05316	575	EP24204PF	587	ETFF06	575	I0069	566
E4165	574	E461	573	E695/2	580	EB06	575	EP24204PS	587	ETFM06DX	575	I006910	566
E41651	567	E464	573	E695/3	580	EB061	575	EP43302PF	587	ETFM06SX	575	I0069100	566
E41652	567	E464/26	573	E695/4	580	EB061316	575	EP43302PS	587	ETFS04	575	I0069101	566
E41653	567	E465	573	E695/5	580	EB063	575	EP43304PF	587	ETFS05	575	I006911	566
E41654	567	E465/26	573	E6951/1	580	EB06316	575	EP43304PS	587	ETFS06	575	I00691100	566
E4200	583	E468/337	563	E6951/2	580	EB063316	575	EP44202PF	587	ETFT04	575	I00691200	566
E4210	583	E468/424	563	E6951/3	580	EB07	575	EP44202PS	587	ETFT05	575	I00691300	566
E4220	583	E4700	585	E6951/4	580	EB071	575	EP44204PF	587	ETFT06	575	I00691400	566
E4230	583	E4701	585	E6951/5	580	EB071316	575	EP44204PS	587	ETM04DX	575	I00692	566
E4240	583	E4702	585	E6952/1	580	EB073	575	ER23302PF	587	ETM04SX	575	I006922	566
E4250	583	E4703	585	E6952/2	580	EB07316	575	ER23302PS	587	ETM05DX	575	I006931	566
E4251	583	E4710	585	E6952/3	580	EB073316	575	ER23304PF	587	ETM05SX	575	I006934	566
E4252	583	E4711	585	E6952/4	580	ED05	575	ER23304PS	587	ETM06DX	575	I00696100	567
E4253	583	E4712	585	E6952/5	580	ED05316	575	ER24202PF	587	ETM06SX	575	I00696200	567
E4254	583	E4713	585	E696/1	580	ED06	575	ER24202PS	587	ETMS06DX	575	I00696300	567
E4255	583	E4720	585	E696/2	580	ED06SX	575	ER24204PF	587	ETMS06SX	575	I00696400	567
E4260	581	E4721	585	E696/3	580	ED07	575	ER24204PS	587	ETMT06DX	575	I006965	566
E4265	581	E4722	585	E696/4	580	ED07SX	575	ER43302PF	587	ETMT06SX	575	I006966	566
E4300	574	E4723	585	E6961/1	580	EF7X1904	575	ER43302PS	587	ETSM10	575	I006976	566
E4301	574	E4730	585	E6961/2	580	EF7X1905	575	ER43304PF	587	ETSM12	575	I00698	571
E4302	574	E4731	585	E6961/3	580	EF7X1906	575	ER43304PS	587	ETSM8	575	I00698100	566
E4307	574	E4732	585	E6961/4	580	EF7X704	575	ER44202PF	587	ETTB04	576	I00698200	566
E4308	574	E4733	585	E6962/1	580	EF7X705	575	ER44202PS	587	ETTB04304	576	I00698300	566
E4309	574	E4743	585	E6962/2	580	EF7X706	575	ER44204PF	587	ETTB05	576	I00698400	566
E4311	574	E4751	558	E6962/3	580	EL2331205F	586	ER44204PS	587	ETTB05304	576	I00699	571
E4312	574	E4751/D	558	E6962/4	580	EL2331205S	586	ESF04	576	ETTB06	576	I006999	567
E4313	574	E47511	558	E700	558	EL2331207F	586	ESF041	576	ETTB06304	576	I0069991	567
E4314	574	E47511/D	558	E700	565	EL2331207S	586	ESF041316	576	EV005/6000	556	I0069996	567
E4315	574	E4753	558	E700316	558	EL2421205F	586	ESF043	576	EV0050/6000	556	I0069997	567
E440	565	E4754	558	E704	565	EL2421205S	586	ESF04316	576	EV105/6000	556	I00700	568
E446	565	E4754/D	558	E706	565	EL2421207F	586	ESF043316	576	EV1050/6000	556	I00710	568
E4464	565	E4755	558	E721	565	EL2421207S	586	ESF05	576	EV4851/6000	556	I0073	568
E447	564	E4755/D	558	E722	565	EL4331205F	586	ESF051	576	EV4852/6000	556	I0074	568
E447/26	564	E4757	558	E800	565	EL4331205S	586	ESF051316	576	EV5851/6000	556	I0076	568
E4471	564	E480	573	E802	565	EL4331207F	586	ESF053	576	EV5852/6000	556	I0078	568
E4471/26	564	E4801	556	E821	565	EL4331207S	586	ESF05316	576	EW1100001	584	I00791	568
E4482	556	E4801/6000	556	E822	565	EL4421205F	586	ESF053316	576	EW1100002	584	I00792	568
E4483	556	E4806	556	E9105	573	EL4421205S	586	ESF06	576	EW1100003	584	I010	573
E449	565	E4806/6000	556	E910510	573	EL4421207F	586	ESF061	576	EW110000G	584	I0101	573
E4491	565	E481	573	E9110	573	EL4421207S	586	ESF061316	576	EW11004241	584	I0102	562
E450	564	E4849	556	E911010	573	EM2331205F	586	ESF063	576	EW11004242	584	I0103	562
E450/304	564	E4849/6000	556	E9115	574	EM2331205S	586	ESF06316	576	EW11004243	584	I0104	562

I0105	562	I02068	560	I111	557	X0102316/43	577
I011	572	I0212	556	I1111	557	X011316	579
I0111	572	I0213	556	I1112	557	X011316/43	579
I01111	572	I022/S1	560	I1113	557	X01151316	579
I01112	572	I022/S1	560	I1114	557	X01151316/43	579
I0115	572	I0222	560	I113	557	X0119316	579
I01151	572	I0223	560	I113/337	557	X0119316/43	579
I0117	572	I02231	560	I11310	558	X02231316	577
I0119	572	I0224	560	I11320	558	X0223316	577
I0119010	573	I02241	560	I11410	557	X030/S316	577
I0119020	573	I0225	563	I11420	557	X030/S316/43	577
I0119110	573	I0226	563	I11510	557	X031/S1316	577
I0119120	573	I030/S	561	I11520	557	X031S1316/43	577
I01192	564	I0301	561	I2000100	571	X113316	577
I0119210	573	I031/S1	561	I2015	564	X4042	577
I0119220	573	I0311	561	I2100100	571	X40650	577
I01193	563	I034100	560	I2200100	571	X4072	577
I011931	563	I038000	561	I400	557	X4072/43	577
I0119310	573	I038100	561	I40000/SO	571	X40731	577
I0119320	573	I038200	561	I403	556	X4308	579
I01194	563	I038300	561	I4030	571	X4309	579
I011940	564	I038400	561	I4031	571	X4311	579
I011941	563	I038500	561	I4032	571	X4312	579
I0119410	573	I038800	561	I404	556	X443	578
I0119420	573	I038900	561	I40550	571	X443/43	578
I011943	563	I039000	561	I40560	571	X446	578
I011944	563	I039100	561	I40570	571	X446/43	578
I011944	564	I039200	561	I40581	571	X4471	578
I011945	564	I039300	561	I40583	571	X4471/43	578
I0119451	564	I039400	561	I40650	567	X4483	577
I011946	564	I039500	561	I4139	572	X450	578
I011947	564	I039600	561	I4141	572	X450/43	578
I011948	564	I039700	561	I4143	572	X451	578
I01195	572	I039800	561	I4144	572	X451/43	578
I01195/122	572	I039900	561	I4148	572	X452	579
I01195100	572	I040000	561	I4149	572	X454	578
I01196	572	I040100	561	I446	565	X454/43	578
I01196/122	572	I040200	562	I450	564	X455	578
I01196100	572	I040300	562	I451	564	X455/43	578
I01197	563	I040400	562	I453	565	X456	577
I011971	563	I040500	562	I9105	573	X4561	577
I011974	563	I040600	562	I910510	573	X4561/43	577
I011976	563	I040700	562	I9110	573	X458	578
I012	574	I040800	562	I911010	573	X458/43	578
I01211	572	I040900	562	I9115	574	X4581	578
I01212	572	I041000	562	I911510	574	X4581/43	578
I0127	574	I041100	562	I9120	574	X459	577
I0129	574	I041200	562	I912010	574	X465	579
I0130	574	I041300	562	I9125	574	X465/43	579
I0130/SO	574	I041400	563	I912510	574	X468/424	578
I01302	574	I041500	563	I9130	574	X468/43	578
I0170	568	I050	558	I913010	574		
I0172	568	I051	558	X0069	577		
I0181	559	I0631/5	559	X006910	577		
I0182	559	I064	558	X006910316	577		
I019	559	I065	558	X0069991316	577		
I0191	559	I0681	558	X0070316	577		
I0192	559	I0682	558	X009	578		
I020	559	I0690	558	X0091	578		
I020/C	559	I0690/5	559	X00911	578		
I0202	559	I0690/D	558	X00912	578		
I0203	559	I0691	558	X0092	578		
I0205	560	I0691/D	558	X009221	578		
I02051	560	I0695	558	X00931	578		
I02061	560	I0695/5	559	X00950	578		
I02062	560	I0695/D	558	X00955	578		
I02063	560	I0696	558	X00960	578		
I02064	560	I0696/D	558	X00962	578		
I02065	560	I06961	558	X0102316	577		
I02066	560	I06961/D	558	X0102316	577		
I02067	560	I0698	558	X0102316/43	577		



Siamo presenti nelle
maggiori fiere del mondo

We attend the most import
exhibitions in the world



Ordini

1. Gli ordini dovranno pervenire con gli esatti riferimenti del codice articolo IND.I.A., in caso contrario l'azienda non si assume nessuna responsabilità per eventuali errori derivanti dall'errata indicazione.
2. Gli ordini trasmessi agli agenti e/o agli area managers di IND.I.A. SPA si intendono sempre condizionati all'accettazione della azienda tramite conferma d'ordine.
3. Per gli ordini inferiori alla quantità prevista nella confezione di imballo standard, è necessario chiederne preventivamente all'azienda la disponibilità e la fattibilità.
4. Ci riserviamo la facoltà di evadere gli ordini frazionati.
5. Il cliente è tenuto allo scrupoloso controllo della conferma d'ordine.

Resa

1. Non verrà accettata merce resa se non in porto franco e sempre su espressa autorizzazione scritta di IND.I.A. SPA.
2. In ogni caso, non si accetteranno restituzioni di materiale manomesso: arrugginito, accorciato, forato, piegato, storto, verniciato o zincato.
3. IND.I.A. SPA si riserva, inoltre, la facoltà di addebitare al cliente un importo forfettario del 15% sull'equivalente valore della merce resa quale partecipazione alla spesa di controllo, immagazzinaggio e ripristino del materiale.

Consegna e spedizione

1. Quale data di consegna si intende quella della partenza della merce dal nostro stabilimento di Malo (VI) e la consegna si intende fatta al cliente all'atto di uscita dallo stabilimento, anche nel caso in cui la resa sia franco destino.
2. I tempi di consegna espressi nella conferma d'ordine sono indicativi e quindi non impegnativi.
3. La merce viaggia a rischio e pericolo del committente anche se venduta franco destino e non ci assumiamo nessuna responsabilità per ritardi, disguidi, perdite o avarie causate da qualsiasi mezzo di trasporto; i reclami contro il vettore spettano al destinatario.

Reclami

1. I reclami per merce mancante o danneggiata devono essere fatti immediatamente per iscritto sul documento di trasporto che accompagna la merce e controfirmati dal trasportatore.
2. Comunque nessun reclamo, anche inerente la qualità della merce, potrà essere sollevato, sotto pena di decadenza, decorsi 8 giorni dall'arrivo della merce.

Varie

1. I dati tecnici espressi nel catalogo sono indicativi e pertanto i prodotti originali possono differire leggermente dalle misure e dalle fotografie riportate in catalogo. L'azienda, in ogni caso, si riserva il diritto in qualunque momento di apportare modifiche e migliorie ritenute necessarie a suo insindacabile giudizio.
2. Non si risponde per errori di stampa riguardanti le informazioni e le misure indicate a catalogo.
3. IND.I.A. SPA non accetterà la richiesta di rimborso danni senza prima aver avuto la possibilità di verificare il danno stesso ed accertarne una propria colpa. In ogni caso, qualsiasi richiesta di rimborso danni sarà da ritenersi nulla, se il presunto danno verrà comunicato all'azienda dopo la messa in opera del lavoro finito nel quale sono stati utilizzati articoli di IND.I.A. SPA, vista l'impossibilità dell'azienda di verificare una propria colpa a seguito di trattamenti e lavorazioni effettuati dal cliente o da terzi.
4. L'azienda può eseguire articoli su misura, per determinate quantità. Nel caso, su richiesta del cliente, vengano prima prodotti dei campioni ai quali non segue poi una richiesta di produzione dell'articolo su misura, IND.I.A. SPA si riserva il diritto di addebitare al cliente il costo di progettazione e realizzazione dei campioni richiesti. Per eventuali ordini di articoli su disegno oppure di articoli non standard viene richiesto un anticipo pari ad un terzo del valore dell'ordine.

Copyright

1. E' assolutamente vietata la riproduzione anche parziale del presente catalogo, di cui IND.I.A. SPA possiede i diritti di Copy Right.

Foro Competente

1. Eventuali controversie saranno di esclusiva competenza del Foro di Vicenza.

Orders

1. Orders must be placed with the exact reference to IND.I.A.'s item codes, otherwise the company will not bear any responsibility for any possible mistake due to the wrong reference.
2. Orders conveyed by IND.I.A. SPA's agents and/or area managers are always submitted to the company's acceptance through the order confirmation.
3. Orders for quantities lower than the standard pack must be agreed with the company after having checked their availability and possibility of realization.
4. We reserve the right to dispatch the orders partially.
5. The customer must carefully check the order confirmation.

Return of goods

1. The company will grant the return of free delivered goods always after its explicit written authorization.
2. In any case, the company will not accept any return of rusty, cut, pierced, bent, twisted, painted nor galvanized goods.
3. Furthermore, IND.I.A. SPA reserves the right to charge the customer a 15% lump sum on the value of the returned goods as a participation to the charges of checking, stocking and restoring such material.

Delivery and dispatch

1. The dispatch date must be considered as the departure date of the goods from the head office of the company in Malo (VI). The delivery to the customer is carried out at the exit of the goods from the head office, even when the material is free delivered.
2. The delivery terms in the order confirmation are indicative and therefore not binding.
3. The goods are carried at the customer's own risk even if free delivered. The company does not bear any responsibility for delays, losses nor damages due to any mean of transport. The claims to the carriers are up to the customer.

Claims

1. Claims for missing or damaged goods must be immediately written on the delivery note and countersigned by the carrier.
2. Anyway, any claim even concerning the quality of the goods, can not be laid after 8 days from the arrival of the goods.

Any other business

1. Technical data shown in the catalogue are indicative. Therefore, the original products can be slightly different from the sizes and the pictures in the catalogue. In any case, the company reserves the right to make at any time changes and improvements that it considers as necessary.
2. The company does not bear any responsibility for any printing mistake concerning the pieces of information and the sizes indicated in the catalogue.
3. IND.I.A. SPA will not pay any damage request before having checked the damage and having established its own responsibility. In any case, every request of refund will be considered as void after the installation of the finished work realized using IND.I.A. SPA's products. As a matter of fact, the company will not have the chance to establish its own responsibility due to treatments carried out by the customer or third parties.
4. The company can produce custom-made products in different quantities. Should the customer request some samples before the mass production without a further confirmation of the order, the company reserves the right to charge to the customer the planning and realization cost of the requested samples. In case of possible orders of custom-made or non standard items, the company requires a down payment of one third of the order value.

Copyright

1. The reproduction, even partial, of the present catalogue is strictly forbidden, as IND.I.A. SPA owns the copyright of such catalogue.

Place of Jurisdiction

1. Any possible controversy will exclusively fall within the competence of the Jurisdiction of Vicenza.

March 2011



ind.i.a.
Industria Italiana arteferro

Via Vicenza, 6/14
36034 Malo (Vicenza) ITALY
TEL. (+39) 0445 580 580
FAX (+39) 0445 580 874
E-mail: india@arteferro.com
www.arteferro.com - www.arteferroinox.com
www.ilgrandefabbro.com



indital
industria italiana arteferro

HOUSTON - U.S.A.

7947 MESA ROAD - HOUSTON
TEXAS 77028 - U.S.A.
PHONE: (+1) (713) 694-6065 / 1-800-772-4706
FAX: (+1) (713) 694-2055
www.indital.com - forgings@indital.com



industria italiana
arteferro

MIAMI - U.S.A.

2955 N.W. 75th STREET
MIAMI, FLORIDA 33147 - USA
PHONE: (+1) (305) 836-9232 / 1-877-723-6743
FAX: (+1) (305) 836-4113
www.arteferromiami.com info@arteferromiami.com



industria italiana
arteferrosud

AVELLINO - ITALY

Via Piano Alvanella 83024 MONTEFORTE IRPINO (AV)
Tel. (+39) 0825 68 00 81
Fax (+39) 0825 68 34 98
(Per Campania - Puglia - Calabria - Basilicata - Molise)
www.arteferrosud.it-info@arteferrosud.it



ind.i.a.
industria italiana arteferro

FRANCE

Z.A.E. LA BAUME RN 113 - 34290 SERVIAN FRANCE
TEL. (+33) (0) 4.67.39.42.81 (lignes groupées)
Fax (+33) (0) 4.67.39.20.90
www.franceindia.com
france.india@wanadoo.fr



ind.i.a.
industria italiana arteferro

SPAIN

28500 ARGANDA DEL REY (MADRID) - ESPAÑA
C/ ABEDUL, 43 - Poligono "EL GUIJAR"
TEL. (+34) (91) 8701897 - 8700819
FAX (+34) (91) 8700820
info@arteferro.es www.arteferro.es



industria italiana
arteferro dohomont

CROATIA

SIRKOVISCE bb 40324 GORICAN - HRVATSKA
PHONE (+385) (0)40 602-222
Fax PHONE (+385) (0)40 602-230
www.arteferro-dohomont.hr
info@arteferro-dohomont.hr



industria italiana
arteferro

ROMANIA

Targoviste - Romania Soseaua Gaesti, (sat Colanu)
Judetul Dambovita
Tel. 004) 0751060204, (004)0745395590
Fax (004)0745731210
E-mail: info@mobilitforge.com



industria italiana
arteferro

РОССИЯ

603092 Nizhny Novgorod (Russia)
Moskovskoje shosse, 320 B
TEL. (+7) (831) 296-19-99 FAX: (+7) (831) 279-28-63
www.arteferro.ru - www.arteferrorussia.com
info@arteferrorussia.com



industria italiana
arteferro

UKRAINE

5, AVTOPARKOVA, 02660 Kiev - Ukraine
Tel.: (+38) (044) 4920331
Fax: (+38) (044) 4920332
E-mail: arteferroukraine@svitonline.com
www.arteferroukraine.com



industria italiana
arteferro skandinavien

SWEDEN - DENMARK

SWEDEN: Rödås Stutans gata 2 602 28 Norrköping
TEL. (+46) (0) 11182323 - FAX (+46) (0) 11182328
DENMARK: HESSELAGER 19 - DK-2605 BRØNDBY
TEL. +45 4362 2563 - FAX +45 4362 2535
www.arteferro.se - info@arteferro.se



ind.i.a.
industria italiana arteferro

POLAND

ul. Gierdziejewskiego 7
02-495 Warszawa POLAND
Tel +48 (22) 397-79-40
Fax +48 (22) 397-21-55
info@indiapoland.com - www.indiapoland.com



industria italiana
arteferro

MEXICO

Av. E. Martinez Lara # 117 Parque Industrial MILIMEX
Carretera Sta. Rosa Km. 3 Apodaca,
Nuevo León C.P. 66637
Teléfono: (81) 1295-5094 / 1295-5095 - Fax: (81) 1295-5097
info@arteferromonterrey.com www.arteferromonterrey.com



ind.i.a.
industria italiana arteferro

BRASIL

Rua Padre Feijó, 480 CEP 95190-000
São Marcos / Rs Brasil
TEL. - FAX (+55) (0) 54 32911416
www.arteferrobrasil.com.br
arteferro@arteferrobrasil.com.br



industria italiana
arteferro

ARGENTINA

Suarez 760
(1162) Capital Federal Buenos Aires
Republica Argentina
TEL./Fax (+54) 11 43012637
www.laherreria.com



industria italiana
arteferro

CHILE

Los Arrayanes 250, Comuna De Colina,
Santiago De Chile
TEL./FAX (+56) 2 738 7419
www.arteferrochile.cl



industria italiana
arteferro botnic

NIGERIA

Block C/5 Lagos State small scale Industrial
Estate, Fatai Atere Way, Matori, Lagos
Tel. 00234 1 891 4155 - 00234 1 2799 093-4
e-mail: info@arteferrobotnic.com
www.arteferrobotnic.com



arteferro
ARTEFERRO INOX^{A B}
S K A N D I N A V I E N

BrodalsAgend 7 Hus X 433 38 Partille - Sweden
TEL. +46 (0) 31 444060FAX. +46 (0) 31 444511
www.arteferroinox.se
info@arteferroinox.se

